

T2S ADVISORY GROUP (AG)

ECB-PUBLIC
FINAL

06 MARCH 2017

CATALOGUE OF CSDs' RESTRICTION RULES AND THEIR CROSS-BORDER IMPACT ASSESSMENT

–Version 1.0–

Executive Summary

The T2S set-up allows for flexibility in the T2S markets' adaptation process, therefore CSDs have to make choices when it comes to the implementation of their processes and practices with T2S. However, decisions made at a local level on the use of T2S functionality may impact other CSDs and CSD participants. While these decisions might be justified to support the CSD's service offering and operating model, they might affect cross-border settlement in T2S.

Restriction rules are implemented by CSDs whenever controls in the form of additional validations in T2S are required. It is up to each CSD to define which restriction rules it needs to implement. These restriction rules may use Market-Specific Attributes¹ (MSAs) allowing CSDs to further customise the controls they put in place according to their specific operating model. Restriction rules and MSAs are subject to configuration limits within the T2S application, e.g. each CSD in T2S may use up to 10 MSAs in its restriction rules².

The objective of this report is to document all restriction rules and make a factual analysis of their impact on cross-border settlement, by assessing the potential implications and complexities for Investor CSDs and other market participants. This report has no legal value: the valid legal source lies in the specifications that each CSD provides to its customers, which this report seeks to replicate accurately. For each CSD, the analysis distinguishes, when relevant, the restriction rules set as Issuer CSD from those defined as Investor CSD. [The T2S Harmonisation Steering Group (HSG) and the T2S Advisory Group (AG) have endorsed this report for publication.]

¹ An additional data field that a CSD can assign to party, securities account and securities reference data to fulfil specific requirements for the validation and processing of settlement instructions (T2S Glossary definition).

² See UDFS: Limitations of the system, Section "1.7.7. Rule-based configurations" for an exhaustive description.

At this stage, several CSDs have reported that the implementation of MSAs and restriction rules due to Investor CSD activity has been fairly limited, or even not required. Furthermore, all CSDs are well below the ceiling of 10 MSAs. While this information must be taken cautiously until all CSDs have migrated to T2S, it is a positive message as regards the envisaged complexities of combining restriction rules and MSAs as Issuer and Investor CSD. The limited number of rules to be implemented as Investor CSD is possibly the result of the following factors:

- Some restriction rules are already implemented by CSDs in their role as Issuer CSD.
- Many restriction rules are related to an optional service to which the Investor CSD does not need to subscribe. In some cases, this service is not available to Investor CSDs, or the service is market-specific.
- There are several options for the implementation of a specific control, and the usage of a restriction rule or MSA to achieve this control is ultimately the result of a business decision taken by each CSD.
- Only a few restriction rules rely on the usage of MSAs.

Coverage and future updates

This is a living document that intends to provide a catalogue of the CSD restriction rules in T2S and their impact. It relies on the input received from CSDs on the restriction rules and Conditional Securities Delivery (CoSD) rules they intend to implement, consolidated in a single document called “*Reference Data Extension*”.

Compared to the previous version of this report (version 0.6), the catalogue now contains the full scope of T2S CSDs.

Controls achieved through restriction rules and cross-border impact

Restriction rules can be implemented in T2S to achieve different controls:

- Reject or hold settlement instructions at the moment of business validation (MSAs may be used in this case)
- Block settlement related to specific parties, securities and securities accounts
- Restrict securities positions or cash balances within an account

Restriction rules defined by a CSD only apply to its participants and not to participants of Investor CSDs, due to the T2S principle of data segregation by system entity³. However, in the context of cross-CSD settlement, a settlement transaction may still be affected by restriction rules, if realignment movements are generated at the Issuer CSD. This showcases the importance of assessing the technical impacts of restriction rules on the chain of investors (including Investor CSDs) directly or indirectly linked to the Issuer CSD.

³ Each CSD and NCB has a defined data scope in T2S.

Segregation of securities positions can be achieved in T2S by using separate accounts or by creating sub-positions, i.e. position types, using restriction rules⁴. The analysis of CSDs' restriction rules does not invalidate the coexistence of different models between Issuer and Investor CSDs, but implies additional translation effort in case a control needs to be replicated.

Categorisation per business process

Restriction rules are categorised based on a list of business processes defined by the XMAP in order to facilitate a comparison by markets and provide a business context to the analysis. The business processes identified are Corporate Actions, Registration, Taxation, Collateral Management, Insolvency Procedures, Other Regulatory Compliance, External Cash Settlement, External CSD Settlement, Foreign Securities, Issuance, Investment Funds Processing, Limitations due to CSD Legacy Platform, Non-European Regulations, Non-Standardised Securities, Operational Procedures, and Static Data Configuration.

Methodology for quantification of impacts on Investor CSDs

As the catalogue of restriction rules is growing, the elaboration of a methodology to quantify the potential impacts of each restriction rule becomes necessary.

The main objective of this methodology is to highlight which of the restriction rules defined by an Issuer CSD, or Investor CSD when the Issuer CSD is outside T2S, have a higher impact on Investor CSDs. The methodology does not evaluate restriction rules that a CSD defines as Investor CSD of a CSD in T2S. It does neither intend to provide an exhaustive guide for Investor CSDs to enter a specific Issuer CSD market, as the business dimension is only analysed through the restriction rules that CSDs implement in T2S.

Based on services put in place by Issuer CSDs, which are defined as either necessary or optional, the methodology evaluates:

- How difficult it is for Investor CSDs to implement such controls, e.g. if the implementation of the control requires also account segregation and MSA, or instead just requires the implementation of a restriction rule that is already needed for the activity as Issuer CSD;
- What are the consequences for the participants of the Investor CSD if the controls are not implemented, e.g. if it implies a fiscal, regulatory, or settlement risk for the Investor CSD's participants, or if instead it just temporarily blocks settlement flows. The assessment is purely based on a qualitative analysis, and the quantitative aspect, e.g. based on settlement volumes, is not taken into account.

Thanks to a color-coded representation of the overall impact, the reader of the catalogue will be able to quickly identify and assess the need and costs for implementing controls in the form of account segregation and restriction rules based on a given business process and CSD.

⁴ Position types are classified as Case 3 Restriction Type in T2S.

A red colour signals a high overall impact, i.e. a necessary service is costly to implement for Investor CSDs and entails a high or medium risk for its participants, if not implemented in its own structure. When the quantitative impact is known to be low, this is reflected as an additional comment.

It must be emphasised that a red colour for a restriction rule does not necessarily imply a wrong behaviour on the part of the Issuer CSD defining the rule. It is simply meant to draw the attention of the Investor CSD on the potential complexities to implement a service or process, or the potential risks of not implementing a control for this service. Furthermore, it can highlight potential for harmonisation and enhancement of the T2S application, e.g. if all CSDs need to define an MSA for the implementation of the same process or service, an additional static data field can be considered as part of the Change Request management process.

A black colour is flagged in case a necessary service or process for an Investor CSD is not available. A grey colour is flagged in the same situation when the service is optional. The purpose is to highlight potential restrictions to market access in a specific Issuer CSD. The methodology is detailed in Section “2.2 Methodology to quantify impacts on Investor CSDs”. The detailed assessment per restriction rule is documented in Section “5.1 Assessment of restriction rules as per methodology”.

The table on the next page provides an overview of the impacts on Investor CSDs of the restriction rules and MSAs implemented by all T2S CSDs. The overview is displayed by grouping the rules per business process and CSDs, and the impact is displayed according to the methodology’s colour-coded scheme. Whenever a CSD defines one or more restrictions rules per business process, the cell will be filled in with a colour. Otherwise it will be left blank. In case there is more than one restriction rule per business process, the colour of the one that has the highest impact for Investor CSDs will be displayed.

For those cases where a majority of CSDs have defined restriction rules for a business process while other CSDs plan to implement this process without restriction rules in T2S, i.e. in the context of Corporate Actions and Insolvency Procedures, a so-called “sanity check” was performed to confirm to the T2S community that all CSDs have a common understanding of the tools they can use to control settlement in T2S, while ensuring a fair application of the methodology based on accurate and exhaustive information. The feedback provided by those CSDs is reported in the relevant sections.

Table 1 – High-level Impact Overview for CSDs in scope of the report

T2S CSDs	Business Processes – Necessary							Necessary/Optional ⁵		Business Processes – Optional							MSAs	
	Corporate Actions	Registration	Taxation	Insolvency Procedures	Other Regulatory Compliance	Limitations due to CSD Legacy Platform	Operational Procedures	External CSD Settlement	Foreign Securities	Collateral Management	External Cash Settlement	Issuance	Investment Funds Processing	Non-European Regulations	Non-Standardised Securities	Static Data Configuration		
Baltic CSDs (CSDL)	Yellow			Red	Red		Yellow			Green			Green			Grey	Green	5
Baltic CSDs (ECSD)	Yellow			Red	Red		Yellow			Green			Green			Grey	Green	6
Baltic CSDs (LCSD)	Yellow			Red	Yellow		Yellow			Green	Grey		Green			Grey	Green	4
BOGS				Red	Yellow					Green	Grey							4
CDCP	Yellow				Yellow	4% transactions ⁶												0
Clearstream	Yellow	Red			Yellow		Green	Green		Grey	Grey	Yellow		Green			Green	8
Depozitarul Central	Yellow			Red	Red													5
Euroclear FR	Red	Red		Yellow			Yellow		Yellow	Green		Yellow	Green	Yellow	Green	Grey	Green	6
Euroclear BE	Green	0.18% transactions		Yellow			Yellow		Green	Green		Green	Green	Yellow	Green	Grey	Green	6
Euroclear NL	Green			Yellow			Yellow		Green	Green		Green	Green	Yellow	Green	Grey	Green	6
Euroclear FI	Yellow			Red	Red		Green	Green								Grey	Green	5
Iberclear	Yellow						Yellow	Grey	Red								Green	2
Interbolsa					Yellow					Grey	Green	Grey		Yellow			Green	1
KDD	Yellow				Yellow		Yellow					Green					Grey	1
KELER	Red			Red						Yellow	Yellow				Yellow		Green	5
Monte Titoli	Yellow			Yellow	Red			Yellow		Yellow							Green	1
NBB-SSS			Red	Red						Yellow								5
OeKB CSD	Red			Yellow			Yellow	Green		Yellow	Grey					Grey	Green	3
SIX SIS	Yellow			Red														2
VP Lux	Yellow			Yellow														0
VP Securities	Yellow			Yellow														0
MSAs	7	4	4	14	10	0	2	0	5	5	0	6	2	6	4	10		

⁵ Business Processes “External CSD Settlement” and “Foreign Securities” are considered necessary or optional depending on whether the CSD is defining the restriction rules as Issuer or Investor CSD.

⁶ All settlement instructions sent by DCPs and Investor CSDs would be put on CSD Validation Hold for a short lapse of time, but only 4% of transactions incur a risk of cancellation due to restricted securities positions (based on 2015 statistics).

The conclusions per business process, based on the CSDs in scope of the analysis are summarised below:

Corporate Actions

Most CSDs have defined restriction rules for the management of CA. Indeed, CA processing is a necessary process performed by each Issuer and Investor CSD as part of standard customer asset servicing, and this translates in a large number of restriction rules to be implemented on the T2S platform, for the management of CA-related settlement instructions.

A restriction rule that has commonly been defined is the selective blocking of settlement instructions based on the ISIN. It is activated during the period of time in which the CSD(s) are applying the CA and settling CA-related instructions in T2S. A rule defined by the Issuer CSD will not prevent intra-CSD settlement of trade-related transactions at Investor CSDs, unless they replicate the control. According to the feedback collected, the CA event types requiring the activation of this rule are not always defined and differ between CSDs. Note that this does not necessarily imply a problem but may be the result of the complexity of CA handling which require granularity beyond categories or event types to determine which processing to apply. It must however be ensured that Issuer and Investor CSD(s) communicate and identify the CA events and the moments of time at which the restriction rule should be activated.

Segregation of securities positions is mandated in the context of elective CA. Depending on the choice of segregation model, CSDs may decide to implement restriction rules or not, so far the usage of restriction rules is not predominant. The choices made by Investor CSDs to segregate positions may differ from the one of the Issuer CSD, which will result in different setup in terms of restriction rules and securities positions reconciliation mechanisms.

In the case of most CSDs, the overall impact is flagged as yellow. In a few cases, the impact is flagged as red due to the usage of MSAs.

Registration

Many European markets have implemented procedures for registration of securities, but the controls and processes required to perform registration are quite different among CSDs. In the context of the XMAP analysis, this results in different restriction rules being defined by a few CSDs in their role as Issuer CSD.

The restriction rules defined by three CSDs have an impact on Investor CSDs if they decide to service registered securities. The overall impact is flagged as red in all cases, as the processing and settlement of registered securities can generally not be performed in STP mode.

In two cases, Investor CSDs holding registered shares will need to consider implementing account segregation and/or restriction rules to distinguish between settlement of registered and non-registered securities.

In the third case, registered securities are primarily maintained at the registrar and the Issuer CSD only provides settlement services for those securities, when traded on the Stock Exchange (OTC flows are not settled at the CSD). The Issuer CSD maintains an interface with the registrar and ensures that settlement

is conditional to the provision of registration related documentation by the selling and buying parties. Investor positions will not be reflected on T2S accounts, but are kept at investor level at the registrar⁷. It is not clear how Investor CSDs could be involved in this process, as the eligibility to hold those securities is subject to the acceptance of the issuer. In theory, Investor CSDs could still play a role of settlement agent for these securities. In practice, the impact of the restriction at registrar level is strongly mitigated due to the fact that this restriction only concerns 3 non-standardised ISINs with little trading activity (around 4500 trades per year, 0.18% of yearly transactions).

Taxation

Withholding tax calculation procedures are supported by the use of restriction rules by one CSD in its role as Issuer CSD. This may impact Investor CSDs' account structure and settlement flows depending on the tax status of their underlying participants. When a global exemption from withholding tax is not provided, Investor CSDs will have to segregate their participants' holding according to their tax status vis-à-vis the Issuer CSD's authorities, and implement the restriction rules and MSAs defined for this purpose. Therefore, the overall impact is flagged as red.

In another case, a CSD has taken the business decision to limit the scope of financial instruments available to omnibus account holders in order to manage disclosure and reporting requirements to foreign tax authorities, and keep benefitting from a global tax exemption. As the CSD is acting as Investor CSD of a CSD in T2S, it would only impact Investor CSDs accessing the Issuer CSD through a relayed link. As such, the restriction rule stemming from this process is not assessed as per the methodology.

Collateral Management

Restriction rules have been defined by several CSDs to support different services they provide in the context of collateral management.

In the case of some CSDs, at least part of the service is not available to Investor CSDs and therefore the impact is flagged as grey.

In some other cases, Investor CSDs will be able to use collateral management services offered by the Issuer CSD but have to segregate collateral assets accordingly, at the level of CSD participants in their books, and sometimes on the omnibus account; however the related restriction rules do not necessarily need to be replicated, this depends on the operating and segregation model of each Investor CSD. The overall impact is flagged as yellow.

Two other CSDs have defined controls in the context of collateral management that only apply to domestic participants therefore the impact is flagged as green and can be disregarded.

Insolvency Procedures

⁷ In the medium term horizon (2025), these securities will have to be dematerialised or immobilised according to the Article 3 of the CSD Regulation

Many CSDs have defined restriction rules in the context of the insolvency of a participant, to enforce decisions made by competent authorities, i.e. a court order or national regulator, or to suspend the activity of a client.

It is expected that each CSD having DCP or cross-CSD activity will define procedures to handle this situation in T2S. In the context of the present analysis, it results in wide differences in the implementation of restriction rules. Some CSDs will only reject new instructions, while others will block the settlement of existing transactions in T2S, or block specific securities positions. This will result in a different treatment of settlement transactions involving e.g. a suspended client, depending on the CSD.

For several CSDs, the overall impact is flagged as red, due to the usage of MSAs, the importance of having controls in place in case of insolvency of a participant, and the potential risks in case such controls are not put in place. In the other cases, the impact is flagged as yellow.

Following the CSG Task Force on Insolvency, several Change Requests have been raised to further enhance the T2S functionalities and ease operational handling in case of an insolvency of a T2S participant. After implementation of CR558 in November 2016, a new restriction type that alleviates the need to define restriction rules and MSAs in the context of insolvency has been defined, and the XMAP will check with CSDs the need to define other restriction rules and MSAs in this context.

Other Regulatory Compliance⁸

CSDs have defined controls in the form of restriction rules to comply with regulatory requirements in place in their national jurisdiction, internal rules, or, in some other cases, to provide tools to their participants to control settlement activity of their clients.

The need for Investor CSDs to replicate such controls is to be analysed on a case by case basis, i.e. depending on the context and the scope of the regulatory requirement. In other instances, the need for replication will be conditional to the usage of the tools provided by the Issuer CSD.

In the case of several CSDs, the overall impact is flagged as red due to the usage of MSAs and the potential non-compliance with regulatory requirements in the national market. In the other cases, the overall impact is flagged as yellow as the controls are either activated on request of the Investor CSDs, part of the restriction rules required for the CSD to act as Issuer CSD, or do not need to be implemented by Investor CSDs in their own structure.

External Cash Settlement

Several CSDs will offer external cash settlement services to their participants, i.e. settlement in currencies non-eligible in T2S.

To this end, they will use the “Conditional Securities Delivery” (CoSD) functionality available in T2S, which allows blocking the securities leg of the transaction while the cash leg settles outside T2S, and in a

⁸ Restriction rules categorised under this business process are not implemented in the context of insolvency of a participant

second step to release and settle the securities in T2S. One CSD will complement the CoSD process with other restriction rules, to perform additional validations before the Intended Settlement Date⁹.

Most CSDs in scope of this analysis will not offer external cash settlement services to Investor CSDs in T2S, hence the impact is flagged as grey.

One CSD will offer this service to Investor CSDs; it will however require that they also implement controls in the form of CoSD rule(s) in their own structure, i.e. data scope.

There is potential room for harmonisation in the definition of restriction and CoSD rules related to the service; for example, settlement instructions in ineligible currencies are rejected in a CSD, and are eligible to settle as normal FOP in others¹⁰. Handling of erroneous cross-CSD transactions is also different among CSDs.

Issuance

Three CSDs have defined restriction rules in the context of issuance, i.e. mostly to control the actors taking part in the process as well as the usage of specific accounts.

The issuance process itself, i.e. initial credit of the securities, is always carried intra-CSD, and most of the issuance related restriction rules apply exclusively within the Issuer CSD in order to monitor the amount of issued securities and to ensure that the process is initiated according to the specific requirements of the issue. In the case of three-tiered issuance distribution model, the distribution account can be held at Investor CSDs, but it would be up to the Investor CSD to decide whether to implement any specific validations on that account. Therefore, for most of the restriction rules defined, no impact on Investor CSDs has been identified.

However, two rejection rules require special attention from Investor CSDs, due to the potential impact on settlement transactions, i.e. cancellation after matching. In one case, Investor CSDs may need to implement the controls in their own structure. Therefore, the overall impact is flagged as yellow.

External CSD Settlement

The Conditional Securities Delivery (CoSD) functionality available in T2S will be used by most CSDs for scenarios involving a CSD external to T2S where conditionality is required. Some CSDs have implemented rules which alleviate the need for replication at the Investor CSD, therefore the impact is green. For another CSD, the overall impact is flagged as yellow, as their Investor CSDs would also need to implement such controls in case of transaction with the External CSD. Finally, one CSD has decided to rely on restriction rules rather than on CoSD, resulting in the process being partly unavailable to Investor CSDs in T2S¹¹.

⁹ Such validation is required because cash details are not considered for matching in FOP instructions. CR T2S-0526-URD addresses this matter.

¹⁰ A specific procedure is defined to allow the settlement of transactions in non-T2S currencies. More details are provided in Section “4.7 External Cash Settlement”.

¹¹ Investor CSDs must instruct the CSD in ICP mode when delivering to a counterparty external to T2S.

Foreign Securities

One CSD has put in place validations in the form of restriction rules, to ensure the consistency of securities holdings resulting from cross-CSD activity, inter alia foreign securities held at the CSD, and the account types holding these securities. Some of these securities cannot be held on the account dedicated to registered securities, and in the case where Investor CSDs hold foreign securities through the CSD, they should implement the restriction rules and MSAs with relevant values for their activity. The overall impact is therefore flagged as yellow (when the CSD is acting as Investor CSD of an external Issuer CSD).

Another CSD, acting as Issuer CSD for securities denominated in non-Euro currencies, has implemented controls in the form of restriction rules in order to ensure that CSD participants hold a dedicated cash account in the respective currency for the purpose of CA payments. The overall impact is flagged as red, as Investor CSDs that wish to service those securities should consider implementing similar controls in their data scope.

Investment Funds Processing

Three CSDs have defined restriction rules related to redemption of funds.

The rules put in place by one CSD ensure that funds securities positions are blocked into a specific sub-position prior to redemption. Investor CSDs holding these securities shall also segregate and restrict these positions for settlement in their account structure via the use of a restriction rule. The overall impact is therefore flagged as yellow. At the time of writing, this service is rarely used by the CSD's participants and the quantitative impact is expected to be limited.

The other CSDs have defined restriction rules for operations of subscription and redemption of fund shares. The process is fully transparent for the Investor CSD and therefore, the impact is flagged as green.

Limitations due to CSD Legacy Platform

CSDs' implementation choices in their adaptation to T2S may result in limitations in the scope of functionalities or settlement services available to CSD participants. In the case of one CSD, some securities positions are not mirrored in T2S, which requires systematic additional business validations in case of transactions involving DCPs or Investor CSDs. The overall impact is flagged as black due to the inability for Investor CSDs to trade those securities on which such restriction exists, and implement any controls. The quantitative impact is however deemed low (affects 4% of transactions¹²) and the CSD will re-consider the implementation of this process after migration to T2S.

Non-European Regulations

Non-European Regulations refer here to the controls put in place by CSDs to comply with non-European regulatory requirements in the context of their activity as Issuer or Investor CSD.

¹² Annual volume (year 2015): DVP - 8 980 / FOP - 46 788 transfers

CSDs, as part of their commercial service offering, may also provide optional services to their participants in order to facilitate the disclosure requirements imposed by non-European Regulations.

In the context of the TEFRA-D regulation, two CSD have defined controls to support intermediaries in the identification of end-investors. When this optional service is used by Investor CSDs, they need to consider whether to implement the rules and relevant MSAs defined by the CSDs, or a similar mechanism based on segregation of securities positions, in order to prevent settlement of TEFRA-D securities during the lock-up period. In one of the cases, the overall impact is flagged as yellow. In the other case, the CSD has put mitigation measures in place to reduce the impact on Investor CSDs, and therefore, the impact is flagged as green.

Non-Standardised Securities

European markets tend towards full dematerialisation or immobilisation of securities instruments in the medium term, but a small fraction of physical securities are still traded among participants. Such physical instruments, represented by individual certificates are immobilised in the Issuer CSD and subsequently traded by book-entry. Other CSDs still hold some non-standardised securities identified by a specific sequence or serial number, making them non-fungible from a settlement perspective.

Based on the CSDs in scope of this analysis, one has the impact flagged as green, two others have the impact flagged as yellow, and a third one as grey, as the service is not available to Investor CSDs¹³. In all cases, taking into account quantitative aspects, the impact on Investor CSDs is deemed very limited.

Operational Procedures

Operational procedures will be put in place by CSDs in order to deal with contingency situations and take corrective actions.

In this context, several CSDs have defined special restriction rules that will allow them to by-pass the other restriction rules they have put in place. These restriction rules could be considered by all CSDs in T2S having defined additional controls in the form of restriction rules, to manage potential contingency situations and be able to by-pass specific validations, depending on their operational needs.

One CSD has defined a restriction rule to reserve the usage of a specific transaction code to Central banks in the context of monetary policy operations, as well as a temporary restriction rule in the context of the pre-migration to T2S, where T2S actors are granted technical access to the platform, to prevent any settlement until go-live. The above rules are all flagged as green as they have no impact on Investor CSDs.

Other CSDs have implemented restriction rules in order to block settlement on a securities, account, party, or ISIN in contingency situations: one of the rules regarding blocking of an ISIN is linked to a

¹³ Settlement in those ISINs require the CSD to be instructed in ICP mode.

CSDR requirement regarding reconciliation¹⁴, other rules are linked to changes of fractional digits not covered by CR538¹⁵. The impact is flagged as yellow, as the blocking may need to be activated by Investor CSDs.

Static Data Configuration

Several CSDs will put in place restriction rules related to static data configuration to support their operational model, or, to provide further flexibility to participants in the choice of their account structure.

In the cases of some CSDs, restriction rules have been defined to reduce the scope of functionalities in T2S as regards the management of securities sub-positions. The impact is flagged as grey, as it may impact Investor CSDs' operating model as regards segregation model for securities positions.

When these restriction rules have been defined to support internal processes, such as preventing settlement prior to deletion of an account, restriction rules do not need be replicated and impact on Investor CSDs can be considered low: the impact is flagged as green in one case, yellow in the other due to the usage of MSAs.

When these restriction rules have been defined to allow segregation of securities positions within omnibus accounts on request of Investor CSDs, Investor CSDs will also need to implement this segregation in their books to ensure consistency of available securities positions. The overall impact is also flagged as green.

¹⁴See CSDR Level 2, Article 86(2) of the Draft Regulatory Technical Standards (RTS) on CSD Requirements (ESMA/2015/1457/Annex II)

¹⁵ Note that the actual operational procedure to be put in place to manage residual cases not covered by CR538 is under discussion at the OMG and could

Table of contents

1. Introduction	1817
1.1 Background	1817
1.2 Scope of Work	1817
1.3 Out of Scope.....	2019
2. Methodology and Framework	20
2.1 Assessment Framework.....	20
2.2 Methodology to quantify impacts on Investor CSDs.....	2224
2.2.1 Introduction	2224
2.2.2 Assessment of impacts based on a top-down approach.....	22
2.2.3 Definition of standardised criteria.....	2322
2.2.4 Classification of restriction rules per colour-coded scheme	2726
2.2.5 Combination of criteria and statuses	2827
2.3 Execution Approach	2928
3. Generic T2S Concepts.....	2928
3.1 Restriction Types.....	2928
3.2 Restriction Rules in a Cross-CSD Context.....	3130
3.2.1 Impact on Investor CSD Settlement Flows.....	3130
3.2.2 Potential Complexities linked to Rules Propagation	38
3.3 Conditional Securities Delivery (CoSD).....	39
3.4 Segregation Models	4039
4. Detailed Business Process Assessment	46
4.1 Corporate Actions	46
4.1.1 Baltic CSDs	49
4.1.2 BOGS.....	50
4.1.3 CDCP	51
4.1.4 Clearstream Banking Frankfurt (CBF).....	52
4.1.5 Depozitarul Central.....	54
4.1.6 ESES (Euroclear Belgium, Euroclear France, Euroclear Netherlands).....	56
4.1.7 Euroclear Finland	60
4.1.8 Iberclear	62
4.1.9 Interbolsa.....	65
4.1.10 KDD	69
4.1.11 KELER.....	70
4.1.12 LuxCSD	72
4.1.13 Malta Stock Exchange.....	72
4.1.14 Monte Titoli.....	72

4.1.15	NBB-SSS.....	76
4.1.16	OeKB CSD	76
4.1.17	SIX-SIS.....	77
4.1.18	VPLux.....	79
4.1.19	VP Securities.....	80
	<i>Conclusion</i>	81
4.2	Registration	85
4.2.1	Clearstream Banking Frankfurt (CBF).....	86
4.2.2	ESES (Euroclear Belgium, Euroclear France, Euroclear Netherlands).....	90
	<i>Conclusion</i>	102
4.3	Taxation.....	105
4.3.1	Iberclear	106
4.3.2	NBB-SSS.....	107
	<i>Conclusion</i>	111
4.4	Collateral Management.....	113
4.4.1	Baltic CSDs	114
4.4.2	BOGS.....	115
4.4.3	Clearstream Banking Frankfurt (CBF).....	117
4.4.4	ESES (Euroclear Belgium, Euroclear France, Euroclear Netherlands).....	118
4.4.5	Interbolsa.....	120
4.4.6	KELER.....	123
4.4.7	Monte Titoli.....	125
4.4.8	NBB-SSS.....	127
4.4.9	OeKB CSD	128
	<i>Conclusion</i>	130
4.5	Insolvency Procedures.....	133
4.5.1	Baltic CSDs	134
4.5.2	BOGS.....	140
4.5.3	Clearstream Banking Frankfurt (CBF).....	141
4.5.4	Depozitarul Central.....	142
4.5.5	ESES (Euroclear Belgium, Euroclear France, Euroclear Netherlands).....	143
4.5.6	Euroclear Finland	145
4.5.7	Interbolsa.....	146
4.5.8	KELER.....	146
4.5.9	LuxCSD	150
4.5.10	Malta Stock Exchange.....	150
4.5.11	Monte Titoli.....	150
4.5.12	NBB-SSS.....	151
4.5.13	OeKB CSD	154

4.5.14	SIX-SIS	155
4.5.15	VP Lux	157
4.5.16	VP Securities.....	158
	<i>Conclusion</i>	158
4.6	Other Regulatory Compliance.....	161
4.6.1	Baltic CSDs	161
4.6.2	BOGS.....	164
4.6.3	CDCP.....	165
4.6.4	Clearstream Banking Frankfurt.....	166
4.6.5	Depozitarul Central.....	167
4.6.6	Euroclear Finland	169
4.6.7	Interbolsa	173
4.6.8	KDD	174
4.6.9	Monte Titoli.....	175
	<i>Conclusion</i>	176
4.7	External Cash Settlement	178
4.7.1	Baltic CSDs	179
4.7.2	BOGS.....	180
4.7.3	Clearstream Banking Frankfurt (CBF).....	183
4.7.4	Interbolsa.....	185
4.7.5	KELER.....	187
4.7.6	OeKB CSD	188
	<i>Conclusion</i>	189
4.8	External CSD Settlement.....	191
4.8.1	Clearstream Banking Frankfurt (CBF).....	192
4.8.2	Euroclear Finland	193
4.8.3	Iberclear	195
4.8.4	Monte Titoli.....	196
4.8.5	OeKB CSD	198
	<i>Conclusion</i>	200
4.9	Foreign Securities.....	201
4.9.1	ESES (Euroclear Belgium, Euroclear France, Euroclear Netherlands).....	201
4.9.2	Iberclear	205
	<i>Conclusion</i>	207
4.10	Issuance.....	208
4.10.1	Clearstream Banking Frankfurt (CBF).....	211
4.10.2	ESES (Euroclear Belgium, Euroclear France, Euroclear Netherlands).....	214
4.10.3	KDD.....	219
	<i>Conclusion</i>	221

4.11	Investment Funds Processing	223
4.11.1	Baltic CSDs	223
4.11.2	ESES (Euroclear Belgium, Euroclear France, Euroclear Netherlands).....	224
4.11.3	Interbolsa.....	226
	<i>Conclusion</i>	227
4.12	Limitations due to CSD Legacy Platform	228
4.12.1	CDCP	228
	<i>Conclusion</i>	229
4.13	Non-European Regulations	230229
4.13.1	Clearstream Banking Frankfurt (CBF).....	230
4.13.2	ESES (Euroclear Belgium, Euroclear France, Euroclear Netherlands).....	233
	<i>Conclusion</i>	234
4.14	Non-Standardised Securities.....	235
4.14.1	ESES (Euroclear Belgium, Euroclear France, Euroclear Netherlands).....	236
4.14.2	Interbolsa.....	237
4.14.3	KELER.....	238
4.14.4	OeKB CSD	240
	<i>Conclusion</i>	242
4.15	Operational Procedures	243
4.15.1	Baltic CSDs	243
4.15.2	Clearstream Banking Frankfurt (CBF).....	244
4.15.3	ESES (Euroclear Belgium, Euroclear France, Euroclear Netherlands).....	248
4.15.4	Euroclear Finland	249
4.15.5	Iberclear	250
4.15.6	KDD.....	252
4.15.7	OeKB CSD	253
	<i>Conclusion</i>	254
4.16	Static Data Configuration.....	256
4.16.1	Baltic CSDs	256
4.16.2	Clearstream Banking Frankfurt (CBF).....	257
4.16.3	KDD.....	259
4.16.4	ESES (Euroclear Belgium, Euroclear France, Euroclear Netherlands).....	260
4.16.5	Euroclear Finland	264
4.16.6	Iberclear	267
4.16.7	Interbolsa.....	269
4.16.8	KELER.....	270
4.16.9	Monte Titoli.....	272
4.16.10	OeKB CSD	273
	<i>Conclusion</i>	274

5. Appendix.....276
5.1 Assessment of restriction rules as per methodology276

1. Introduction

1.1 Background

The Cross-Border Market Practices Sub-Group (XMAP) was mandated by the Harmonisation Steering Group (HSG) to analyse the impact of existing and diverging market practices on cross-border settlement efficiency in T2S. The HSG is responsible for the validation of the outcome of Sub-Group analysis.

In this context, the CSD Steering Group (CSG) made the initial consolidated version of the intended rules and restrictions of CSDs in T2S transparent in September 2013 (first version of the document *TARGET2-Securities CSDs' Restriction Rules*) and agreed that XMAP should analyse the rules and restrictions from the cross-CSD processing point of view. The outcome of XMAP assessment exercise would provide the basis for further discussion and support on the CSDs' restriction rules in T2S. The XMAP's assessment focuses on the business scenarios and the business rules behind the restrictions setup in T2S.

1.2 Scope of Work

Baseline document

The XMAP analysis is based on the CSG documentation “*CSDs' Reference Data Extension*”, and the version 1.8¹⁶ is used as a baseline for this iteration of the report. The catalogue now includes all the rules that will be implemented as Issuer CSD and/or Investor CSD for the full scope of T2S CSDs, but while it is considered that restriction rules are stable for all CSDs, changes may occur and this document must be considered as a living document. The process for updating the rules after migration will be carried out in line with the current T2S governance process, each new version of the Catalogue being approved by the AMI SeCo.

Objective

The objective of the assessment is to analyse the impact of restriction rules on cross-border business and assess the potential complexities and implications for Investor CSDs to implement restriction rules in their markets based on the Issuer CSDs'¹⁷ adaptation choices. The cross-CSD impact analysis will cover two key dimensions:

- Impact on Investor CSD account configuration

This dimension involves analysis of the needs for segregation of securities holdings (using either distinct securities accounts or position types) in the Issuer CSD defining the rule. The objective of this activity is to ascertain the need for Investor CSDs to replicate the Issuer CSD's securities holding structure in their own books and analyse the implications of segregation on the Investor CSD participants' securities

¹⁶ Following bilateral clarifications, the need for updates on the restriction rules of Euroclear Finland were identified and consequently integrated in this version of the Catalogue. These updates will be reflected in the next version of the Reference Data Extension.

¹⁷ Issuer CSD must be understood here as rules defined by a CSD for its participants. The concept of Issuer CSD may or may not be relevant depending on the business process being analysed.

account structure. Please note that the analysis is limited to account segregation used in the context of the restriction rules.

- Impact on Investor CSD settlement flows

This dimension involves analysis of the impact of Issuer CSD restriction rules on Investor CSDs linked via direct or relayed links to the (Issuer) CSD. The objective of this activity is two-fold:

- Identify and describe the technical impacts of the restriction rules defined by (technical) Issuer CSDs on cross-CSD settlement
- Analyse the need to replicate the (Issuer) CSD restriction rules in the Investor CSD from a business process perspective. In addition, the analysis also covers the MSAs used by Issuer CSDs for the definition of restriction rules and the possible need to propagate the Issuer CSD's MSAs to the Investor CSD due to replication of restriction rules.

List of Business Processes identified by the XMAP for the Analysis of Restriction Rules

CSDs have defined restriction rules for business processes wherein controls in the form of additional validations in T2S are required. Some of these business processes (e.g. registration, taxation, corporate actions...) are common across markets whereas other business processes are specific to some markets and result from market practices, regulatory requirements, or specific service offering. The assessment of the restriction rules will be done by business process as opposed to a specific CSD (or market) focus. This approach will facilitate the comparison of T2S adapted processes across CSDs and help identify best market practices for implementation of restriction rules in T2S.

Each restriction rule defined by CSDs is assigned to one of the business processes below as defined by the XMAP.

- Corporate Actions
- Registration
- Taxation
- Collateral Management
- Insolvency Procedures
- Other Regulatory Compliance
- External Cash Settlement
- External CSD Settlement
- Foreign Securities
- Issuance
- Investment Funds Processing
- Limitation due to CSD Legacy Platform

- Non-European Regulations
- Non-standardised Securities
- Operational Procedures
- Static Data Configuration

Coverage and future updates

Compared to the previous version of this report (version 0.6), the catalogue now contains the full scope of restriction rules for T2S CSDs. Euroclear Finland has been added to the catalogue with this iteration.

The scope of restriction rules for the CSDs included in the previous version remains unchanged, except for OeKB.

The XMAP may at that stage identify best market practices for the fulfilment of a given business process with a 2018 horizon. This may take the form of proposing to CSDs a standardised way of defining a restriction rule for a certain business process. It may also take the form of proposing to make it part of the standard T2S functionality via Change Request in future releases (after the migration period) if this is deemed more efficient.

1.3 Out of Scope

As part of the assessment, the ECB Team also analyses the technical feasibility of the restriction rules from T2S perspective and bring forth these findings to the respective CSD through bilateral exchanges. However, the XMAP assessment exercise does not validate if the CSD restriction rules fully achieve the objective of the intended adaptation of the CSD's business process. This is primarily due to the limited view of the CSD service offering and market-specific process details available to the XMAP.

2. Methodology and Framework

2.1 Assessment Framework

The analysis framework for CSD restriction rules comprises 5 activity components:

Figure 1 – XMAP Assessment Framework for CSDs’ Restriction Rules Analysis

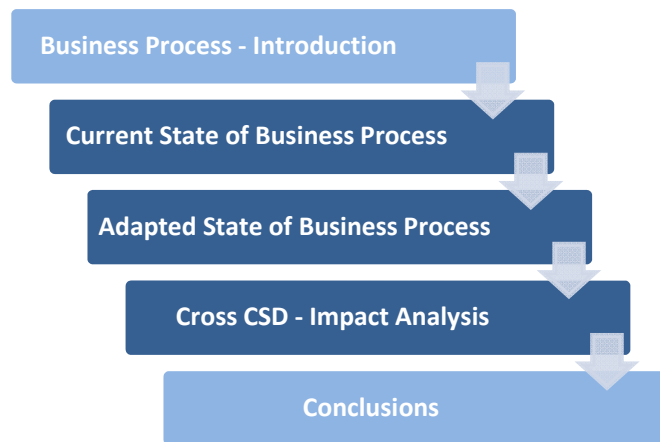

- **‘Business Process – Introduction’** (Defines the general business process)

This activity focusses on providing a definition and high-level description of the business process that is relevant for the restriction rules analysis. It provides generic explanations on the way the business process is handled prior to T2S and, when relevant, the changes that are required when migrating to T2S. The objective of this activity is to establish a common understanding of the business process across all stakeholders.

- **‘Current State of Business Process’** (Describes the current process with emphasis on the process controls)

This activity focusses on the controls currently implemented in the CSD systems and operations for the business process. The objective of this activity is to establish the context and provide the background for the need to implement the restriction rules in T2S.

- **‘Adapted State of Business Process’** (Describes the target state process with the controls envisaged using the T2S restrictions framework)

This activity focusses on the description of the restriction rules that will be implemented for the business process. MSAs used in this context are also described. The activity helps in understanding the tools and procedures to be used by CSDs to implement existing or new market practices and facilitates the comparison of control mechanisms in T2S for same business process across multiple markets.

- **‘Cross-CSD – Impact Analysis’** (Analyses the impact of the process controls on cross-CSD settlement in T2S)

This activity focusses on analysing the impacts of (Issuer) CSD restriction rules on Investor CSDs’ account configuration and settlement flows. The analysis identifies cases where segregation of securities positions is required in the CSD defining the rule and examines the need for replicating the segregation in Investor CSDs of this CSD. From a settlement perspective, the study assesses the technical impacts of restriction rules defined by (Issuer) CSDs on cross-CSD transactions, as well as the need to replicate the rule from a business process standpoint.

- **‘Conclusions’** (*Summarises the key findings of the analysis*)

This activity focusses on comparing the target state business processes across markets to identify similar needs for business process controls but differing implementations opted by CSDs for T2S adaptation (i.e. use of T2S functional toolkit). Additionally, in cases where feasible, best practices in the form of a standard control or procedure(s) are also recommended. The objective of this activity is to facilitate the identification and adoption of best practices for T2S implementation as well as promote standardisation across T2S markets.

Prior to the assessment by business process, a generic analysis based on T2S functionalities is performed to showcase the potential impacts of restriction rules in a cross-CSD context with:

- An introduction of the different restriction types in T2S and important configuration options
- A description of potential impacts of restriction rules on Investor CSD settlement transactions according to the restriction type and cross-CSD settlement scenario
- A generic impact analysis resulting from account segregation using position types in T2S

2.2 Methodology to quantify impacts on Investor CSDs

2.2.1 Introduction

The main objective of this methodology is to identify which of the restriction rules defined by an Issuer CSD have a higher impact on Investor CSDs, i.e. how difficult is it for Investor CSDs to implement such controls, and what are the consequences for the participants of the Investor CSD if the controls are not implemented. Thanks to a color-coded representation of the overall impact assessed according to standardised criteria, the reader of the catalogue will be able to quickly identify and assess the need and costs for implementing controls in the form of account segregation or restriction rules based on a given business process and CSD.

The methodology does not intend to provide an exhaustive guide for Investor CSDs to enter a specific Issuer CSD market, as the business dimension is only analysed through the restriction rules that CSDs implement in T2S.

2.2.2 Assessment of impacts based on a top-down approach

The XMAP has taken the approach to categorise restriction rules based on a list of business processes that CSDs put in place. Following a top-down approach, an XMAP business process can be seen as the starting point that may eventually lead to the implementation of a restriction rule by an Issuer CSD, as illustrated below:

Figure 2 – XMAP’s top-down approach based on business processes

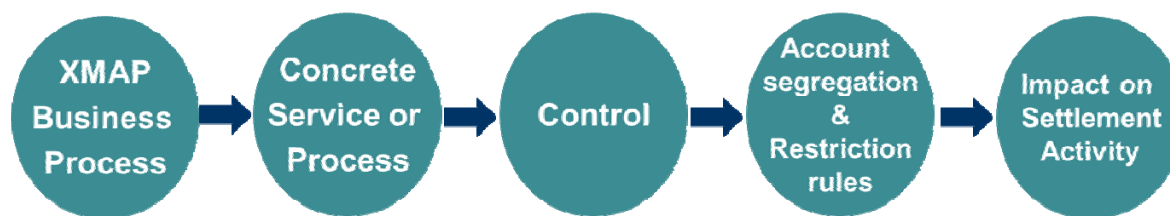

- For a given business process, a particular service or process may require the implementation of specific controls related to settlement in order to fulfil the intended purpose;
- Such controls may take the form of account segregation and/or restriction rules in T2S to ensure the appropriate effect on settlement transactions.

2.2.3 Definition of standardised criteria

The elaboration of a methodology to measure impact of restriction rules on Investor CSDs requires the definition of standardised criteria. From the perspective of Investor CSDs, the need for implementing specific controls based on their investor activity with the Issuer CSD can be evaluated according to the following questions:

- Is the business process and underlying service provided by the Issuer CSD necessary for the Investor CSD to service its participants?
- Does the provision of this service or process mandate the implementation of controls in the Investor CSD structure (i.e. data scope), in the form of account segregation or restriction rules in T2S?
 - If yes, are these controls to be already implemented when the Investor CSD acts as Issuer CSD?
 - If not, what is the potential impact for the Investor CSD of not implementing such controls?

Based on the above, the following criteria have to be assessed for each restriction rule implemented by a CSD in its role as Issuer CSD or Investor CSD of a CSD outside T2S¹⁸ to determine the impacts on Investor CSDs:

Criterion 1- Character of the Service/Process

Table 2 – Criterion 1 - Definition of necessary/optional service

Attribute	Definition
Necessary	A service or process that is necessary for all participants of the Issuer CSD, including the Investor CSDs ¹⁹ .

¹⁸ Restriction rules defined as Investor CSD of a CSD in T2S are not assessed with the methodology

¹⁹ The definitions of necessary or optional services are not based on the concepts of core and ancillary services as described in the CSD Regulation. The categorisation is done at the level of the business process and not at the level of each restriction rule

Attribute	Definition
	<i>This encompasses typically settlement in Central bank money, registration and account servicing functions for the full scope of securities and currencies in T2S²⁰, as well as mandatory requirements of regulatory and fiscal nature.</i>
Optional	<p>The service or process is optional for all participants of the Issuer CSD, including the Investor CSDs.</p> <p><i>For example, specific collateral management services or cash settlement in non-euro commercial bank money can be considered as optional.</i></p>

Criterion 2- Effort of implementing controls in Investor CSD’s own structure

Note: For the purpose of assessing criterion 2, a CoSD rule is equivalent to a restriction rule

Table 3 – Criterion 2 – Definitions

Attribute	Definition
Not available	<p>An Investor CSD cannot ensure good operation of the service or process via controls in the form of account segregation or restriction rules in its own structure, because the service or process is not offered by the Issuer CSD. This unavailability to Investor CSDs may result from market practices, regulatory framework, technical constraints, or business decision of the Issuer CSD.</p>
High	<p>To ensure good operation of the service or process, controls in the form of:</p> <ul style="list-style-type: none"> • Segregation of securities positions <u>and</u> restriction rules need to be implemented by an Investor CSD in its own structure. Investor CSDs have to consider implementing such controls in addition to those that they setup for their activity as Issuer CSD. <p><u>OR:</u></p> <ul style="list-style-type: none"> • Additional MSA(s) may need to be implemented by an Investor CSD in its own structure based on the configuration defined by the Issuer CSD²¹. This is regardless of whether Investor CSDs have to consider implementing an

²⁰ Non-standardised securities and physical securities represented by an individual certificate, which may still be settled in T2S, are not part of this scope

²¹ I.e. if the Issuer CSD has defined an MSA for the configuration of this rule; note that MSAs will always be implemented in conjunction with a restriction rule, unless used for information purposes

Attribute	Definition
	MSA for this process or service for their activity as Issuer CSD
Medium	<p>To ensure good operation of the service or process, controls in the form of:</p> <ul style="list-style-type: none"> • MSA(s) do <u>not</u> need to be implemented by an Investor CSD in its own structure based on the configuration defined by the Issuer CSD. • Either segregation of securities positions <u>or</u> restriction rules need to be implemented by an Investor CSD in its own structure; Investor CSDs have to consider implementing such controls in addition to those that they setup for their activity as Issuer CSD. <p><u>OR;</u></p> <ul style="list-style-type: none"> • Segregation of securities positions <u>and</u> restriction rules need to be implemented by an Investor CSD in its own structure; however, such controls are generally necessary for Investor CSDs for their activity as Issuer CSD.
Low	<p>To ensure good operation of the service or process, controls in the form of:</p> <ul style="list-style-type: none"> • MSA(s) do not need to be implemented by an Investor CSD in its own structure based on the configuration defined by the Issuer CSD. • Segregation of securities positions <u>or</u> restriction rules need to be implemented by an Investor CSD in its own structure; however such controls are generally necessary for Investor CSDs for their activity as Issuer CSD.
None	Controls, whether in the form of account segregation or restriction rule(s), do not need to be implemented by an Investor CSD to ensure good operation of the service or process.

Table 4 – Criterion 2 – Overview of combinations and resulting status

Control to be implemented in the form of (Y/N)			Control generally needed as Issuer CSD (Y/N)	Status
Segregation of securities positions	Restriction rules	Market-Specific Attributes		
Not available				

Control to be implemented in the form of (Y/N)			Control generally needed as Issuer CSD (Y/N)	Status
Y	Y	Y	Any value	High
N	Y	Y	Any value	High
Y	Y	N	N	High
Y	N	N	N	Medium
N	Y	N	N	Medium
Y	Y	N	Y	Medium
Y	N	N	Y	Low
N	Y	N	Y	Low
N	N	N	N	None

Criterion 3- Risk of NOT implementing controls in Investor CSD’s own structure²²

Table 5 – Criterion 3 – Definitions

Attribute	Definition
High	<p>Potential consequences if the controls are not implemented:</p> <ul style="list-style-type: none"> • Automatic cancellation of business instructions after matching or; • Undue settlement of securities that are e.g. restricted from settlement at the Issuer CSD or; • Rights over the security cannot be exercised or; • Non-compliance with regulatory or fiscal requirements
Medium	<p>Potential consequences if the controls are not implemented:</p> <ul style="list-style-type: none"> • Settlement transaction pending due to restriction rule applying on the realignment instructions (instead of the business instructions) and; • Risk of manual cancellation of the transaction²³

²² The analysis focuses on qualitative aspects and the quantitative dimension is not taken into account for the assessment of this criterion

²³ Instructions which are pending due to a restriction rule have to be bilaterally cancelled by the counterparties as they do not fulfil the additional validations or requirements set by the Issuer CSD

Attribute	Definition
Low	<p>Potential consequences if the controls are not implemented:</p> <ul style="list-style-type: none"> • Settlement transaction pending due to restriction rule applying on the realignment instructions (instead of the business instructions) and; • No risk of manual cancellation of transactions;
None	No impact on settlement activity of the Investor CSD if the controls are not implemented.

2.2.4 Classification of restriction rules per colour-coded scheme

The overall impact of a restriction rule will be represented according to a colour-coded scheme, in order to provide a visual representation to the reader:

Table 6 – Overall impact assigned to a restriction rule according to the methodology

Colour	Definition
Black	A necessary service or process for an Investor CSD is not available. Hence, the Investor CSD cannot put any controls in place and it raises the question whether the Issuer CSD is compliant with the CSD access criterion 3 of T2S ²⁴
Grey	An optional service or process for an Investor CSD is not available. This implies that there is no impact of implementing or not implementing the controls for the Investor CSD, but it may signal restrictions to market access in the Issuer CSD defining the controls.
Red	A service is necessary for the Investor CSD and has either a high impact in order to implement the controls (combined with a high or medium impact if the controls are not implemented), or a high impact if the controls are not implemented (combined with a high or medium impact in order to implement the controls).
Yellow	<p>When the service is necessary for the Investor CSD, it has a medium impact in order to implement the controls and a medium impact if the controls are not implemented (or a high/low combination of the above).</p> <p>When the service is optional for the Investor CSD, it either has a high impact in order to implement the controls (combined with a high or medium impact if the</p>

²⁴ CSD access Criterion 3: “CSDs are eligible for access to T2S services provided that they make each security/International Securities Identification Number for which they are an issuer CSD, or technical issuer CSD, available to other CSDs in T2S upon request. Source: T2S Eligibility criteria for CSDs (ECB/2011/20)

Colour	Definition
	controls are not implemented), or a high if impact if the controls are not implemented (combined with a high or medium impact in order to implement the controls).
Green	<p>When the service is necessary for the Investor CSD, it has a low impact in order to implement the controls and a low impact if the controls not implemented (or a medium/low combination of the above).</p> <p>When the service is optional for the Investor CSD, it has a medium impact in order to implement the controls and has a medium impact if the controls are not implemented (or a high/low combination of the above).</p>

2.2.5 Combination of criteria and statuses

Necessary Service or Process		<i>Risk of not implementing controls</i>			
		High	Medium	Low	None
<i>Effort of implementing Controls</i>	Not available				
	High				
	Medium				
	Low				
	None	_ ²⁵	-	-	

Optional Service or Process		<i>Risk of not implementing controls</i>			
		High	Medium	Low	None
<i>Effort of implementing Controls</i>	Not available				
	High				
	Medium				
	Low				

²⁵A dash signals an impossible combination

Optional Service or Process		Risk of not implementing controls			
	None	-	-	-	

2.3 Execution Approach

From the perspective of performing the CSDs' restriction rules analysis, the framework component 'Business Process – Introduction', will be CSD (or market) agnostic and focus on the generic description of the process. The framework components 'Current State of Business Process', 'Adapted State of Business Process' and 'Investor CSD – Impact Analysis' analyse the CSDs specific business processes, restriction rules and their impacts in an iterative manner for each CSD. The 'Conclusions' will provide a holistic view of the impacts on each business process with some further details specific to each CSD.

Figure 3 – Execution Approach for CSDs' Restriction Rules Analysis

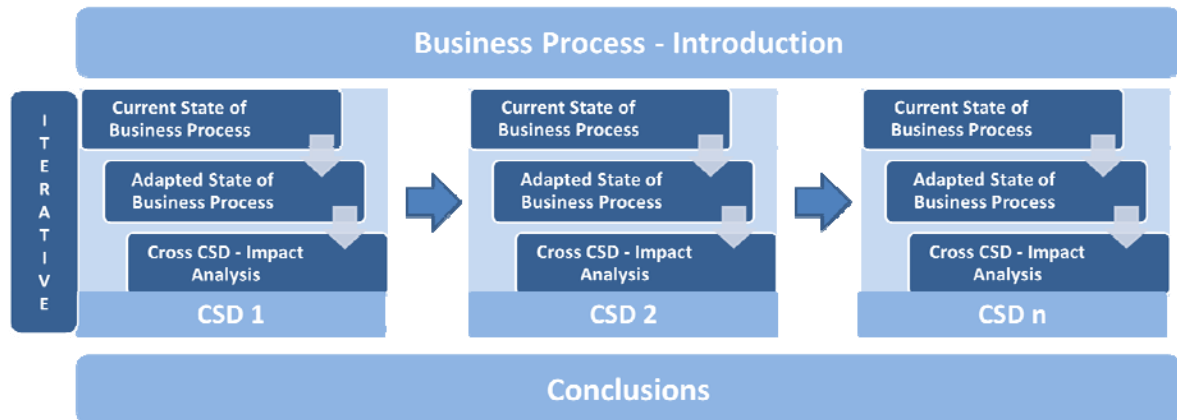

3. Generic T2S Concepts

3.1 Restriction Types

CSDs and NCBs can set up restrictions in T2S through the use of restriction types in order:

- To accept, reject, or put on “CSD Validation Hold” settlement instructions and settlement restrictions at business validation level, i.e. as soon as the instructions are received in T2S (Case 1 Restriction Type);
- To conduct intraday restrictions on parties, securities and securities accounts, external RTGS accounts and T2S dedicated cash accounts to block settlement on the relevant static data object, i.e. on ISD (Case 2 Restriction Type);
- To restrict securities positions or cash balances (Case 3 Restriction Type).

A fourth restriction type has been implemented in T2S as part of CR558 in order to deal with insolvency scenarios, to automatically reject incoming settlement instructions on the securities or dedicated cash

account flagged as under insolvency. This restriction type does not require any configuration from the T2S CSDs, it is only necessary to apply the respective restriction (created by the T2S Operator) to the relevant securities or cash account.

Case 1 and 2 Restriction Types are rule-based models allowing CSDs and NCBs to define rules with a group of parameters and values fulfilling the condition for the restriction to be applied (e.g. settlement instructions with ISO transaction code value “XYZ” instructed by party “123” should be rejected). Restriction rules can be defined with a positive or negative parameter set:

- A negative parameter set is used to determine the conditions under which the restriction should not apply, e.g. a CSD setting an intraday restriction on an ISIN of negative parameter with ISO transaction code “CORP” preventing settlement of any instruction on that ISIN except those related to corporate actions with ISO transaction code “CORP”.
- A positive parameter set is used to define the conditions under which the restriction applies, e.g. a CSD defining a positive restriction rule to reject the settlement instructions sent by a CSD participant (Instructing Party Type = CSD participant) on a specific ISIN.

Since restriction types and restriction rules can only be valid from a future date higher than the current business day, the following time constraints have to be considered for the implementation of restriction rules:

- Creation of Case 1 Restriction Type: can only be defined with a validity date (= Valid From) as from current business date +2 (according to Business Rule DRCL007)
- Creation of Case 2 Restriction Type: can only be defined with a validity date (= Valid From) as from current business date +1 (according to Business Rule DRCL007)
- Creation of a restriction rule: can only be defined with a validity date (= Valid From) as from current business date +1 and on an active Restriction Type (according to Business Rule DRCX010)

As a result, restriction rules based on Case 1 Restriction Type require 2 days minimum before the rule can be active, while as restriction rules based on Case 2 Restriction Type²⁶ require 1 day minimum before the rule can be active.

Usage of Market-Specific Attributes

T2S offers the possibility to CSDs and NCBs to define Market-Specific Attributes (MSAs) in the T2S static data on securities, securities accounts, or parties. An MSA is an additional data field that a CSD can assign to party, securities account and securities reference data to fulfil specific requirements for the validation and processing of settlement instructions²⁷. A given MSA can have several allowed values (e.g.

²⁶ For Case 2 Restriction Types, the definition of a rule is optional. The Restriction Type can also be directly activated on the static data object

²⁷ T2S Glossary definition

MSA “Taxation” on party with possible values “tax exempted” or “tax not exempted”). MSAs can be used in T2S with different goals:

- For information purposes;
- To be used in the configuration of restriction rules in order to reject or put on CSD Validation Hold (Case 1 Restriction Type) settlement instructions so that the scope of the restriction is limited to those incoming instructions matching the value of the MSA defined in the rule (e.g. to put on CSD Validation Hold instructions sent by parties with an MSA on “Taxation” with value equal to “tax not exempted”). MSAs cannot be defined for Case 2 and Case 3 Restriction Types.

3.2 Restriction Rules in a Cross-CSD Context

CSDs have defined restriction rules with a focus on domestic participants, when controls in the form of additional validations in T2S are required for the provision of specific services, such as registration, issuance, or corporate actions. However restriction rules defined by a(n) (Issuer) CSD may have an impact on the whole chain of investors, including Investor CSDs and their participants. The sub-sections below showcase the consequences of setting up restriction rules in a cross-CSD context to highlight the potential impacts on Investor CSDs’ settlement flows, on the other side, to show the potential complexities linked to the MSAs and rules that Investor CSDs might need to replicate (from Issuer CSDs) and combine with their own.

3.2.1 Impact on Investor CSD Settlement Flows

Due to the T2S principle of data segregation by system entity (CSD, NCB), restriction rules defined by a CSD only apply within its own structure, i.e. data scope, and any rule setup by the Issuer CSD will not apply to Investor CSDs’ participants. Nevertheless, in order to provide straight-through processing cross-CSD settlement, T2S builds the realignment chain to debit or credit the relevant omnibus and mirror accounts of the CSDs directly or indirectly affected by the transaction. In this context, the T2S generated Settlement Instructions are subject to the rules setup by the Issuer CSD like any other settlement instruction under its data scope. As a result, restriction rules may still affect a transaction involving an Investor CSD if realignment movements for this transaction are generated at the Issuer CSD.

The following scenarios demonstrate the impacts of restriction rules on settlement transactions involving Investor CSDs, and more precisely, the effect of each restriction type on the underlying settlement instructions (Business Instructions as well as T2S generated Realignment Settlement Instructions) under the assumption that the rule is not replicated and only defined at the Issuer CSD. No distinction is made if the settlement transaction results from a specific business process (e.g. issuance) or from a trade between participants, as both may be equally impacted by a rule.

In many cases, Investor CSDs will not be informed in the status messages sent by T2S on their business instruction(s) that the transaction has been impacted by a restriction rule, unless they replicate the rule in their system entity. Another possibility for Investor CSDs to obtain the information is to subscribe to the

realignment and status messages generated on their omnibus accounts, which will provide information on the restriction rule applied on the realignment instruction(s). Even so, in one specific cross-CSD scenario where a rejection rule is defined by the Issuer CSD, neither the Issuer CSD nor the Investor CSDs are informed in the status messages sent by T2S that a transaction has been cancelled due to a restriction rule²⁸.

Scenario 1: Cross-CSD transaction involving two Investor CSDs where realignment between omnibus accounts takes place at the Issuer CSD

This scenario covers a securities delivery between participants of different Investor CSDs, which have a direct link to the Issuer CSD (the Issuer CSD is defined as their Technical Issuer CSD in T2S), while the restriction rule is only setup at the Issuer CSD.

Figure 4 - Cross-CSD transaction involving two Investor CSDs where realignment between omnibus accounts takes place at the Issuer CSD

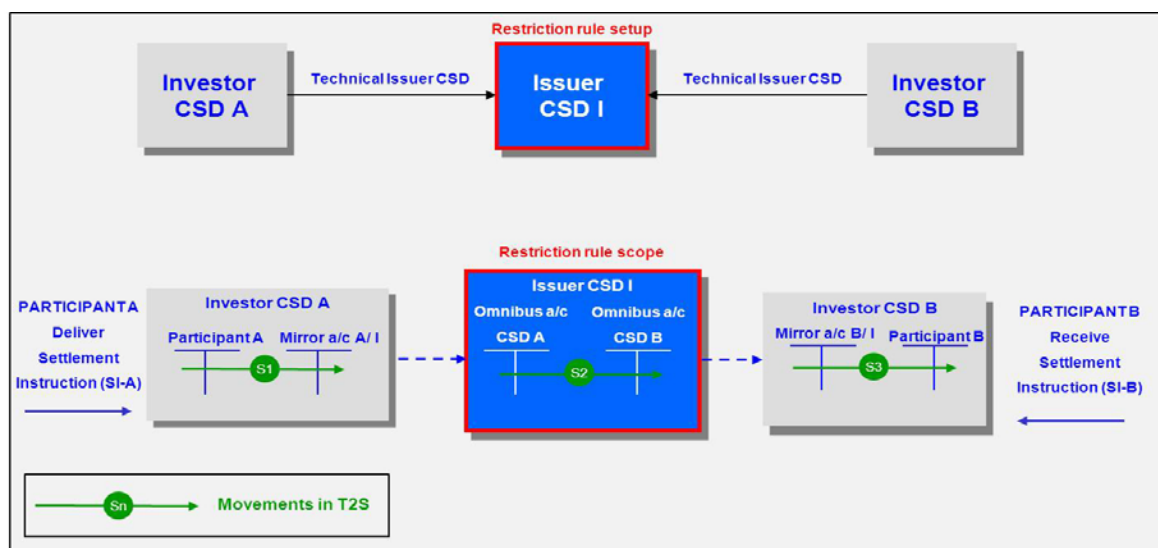

In this case, SI-A and SI-B are outside the scope of the restriction rule setup by the Issuer CSD.

Since this is a cross-CSD transaction between two Investor CSDs, T2S will generate settlement realignment instructions after successful matching to build the realignment chain and debit/credit the correct omnibus and mirror accounts.

In this scenario, the T2S generated Settlement Realignment instructions created for the settlement movement between omnibus accounts at the Issuer CSD will be affected by the rule, which will prevent settlement of the transaction (since all instructions must settle on an all or none basis).

The restriction rule setup at the Issuer CSD may impact the settlement transaction and underlying settlement instructions differently depending on the rule type, as shown in the table below:

²⁸ The XMAP will discuss whether a CR should be envisaged for a further release of T2S to refine the information provided to Investor CSDs in such scenario

Table 7- Cross-CSD transaction involving two Investor CSDs where realignment between omnibus accounts takes place at the Issuer CSD

Restriction rule defined at Issuer CSD	Impact on settlement instructions
Case 1: Rejection (settlement instruction)	SI-A will have status “Matched” then “Cancelled” due to rejection of the T2SgSI SI-B will have status “Matched” then “Cancelled” due to rejection of the T2SgSI T2SgSI will not be generated ²⁹ .
Case 1: CSD Validation Hold (settlement instruction)	SI-A will have status “Matched” and Settlement status “Pending” (Reason code LINK, status sent on Intended Settlement Date) SI-B will have status “Matched” and Settlement status “Pending” (Reason code LINK, status sent on Intended Settlement Date) T2SgSI will have status “Matched” and Settlement Status “Pending” (Reason code CVAL, status sent upon validation of the SI in T2S)
Case 2: Blocking (security, account, party)	SI-A will have status “Matched” and Settlement status “Pending” (Reason code LINK, status sent on Intended Settlement Date) SI-B will have status “Matched” and Settlement status “Pending” (Reason code LINK, status sent on Intended Settlement Date) T2SgSI will have status “Matched” and Settlement Status “Pending” (Reason code SBLO/BLOC ³⁰ , status sent on Intended Settlement Date)
Case 3: Position Type complemented by a rejection (Case 1) on the position type	SI-A, SI-B, and T2SgSIs will not be affected and transaction may settle

The above table illustrates the impacts of restriction rules defined by an Issuer CSD on Investor CSDs³¹.

²⁹ UDFS version 2.0 reference: page 375 “Validity of T2S generated realignment Settlement Instructions “.

³⁰ If restriction is applied on securities, reason code will be SBLO, if on accounts or parties, the reason code will be BLOC

³¹ The initial business transaction takes place between participants of the Investor CSDs

The most impacting case described here above is in the event of a “Rejection” restriction rule, where settlement instructions of Investor CSDs’ participants are cancelled automatically by T2S, after initial acceptance and matching. In this specific case, T2S generated Settlement Realignment Instructions are not created as they do not pass the business validation: the consequence is that the Issuer CSD defining the restriction rule is not notified that the rule has caused the cancellation of the transaction. Investor CSDs are not informed that the cancellation of the transaction is due to a restriction rule³², unless they replicate it in their system entity.

Depending on the counterparties to the trade as well as their link to the (Issuer) CSD defining the rule, the impacts on the settlement transaction involving Investor CSD(s) will vary, as shown in the following scenarios.

Scenario 2: Cross-CSD transaction involving the Issuer CSD and an Investor CSD

This scenario covers a securities delivery between a participant in the Investor CSD and another in the Issuer CSD, while the restriction rule is only setup at the Issuer CSD. It also takes into account the case where the rule comes into effect while Business Instructions are matched, e.g. in case the rule is triggered on the realignment instruction.

Figure 5 - Cross-CSD transaction involving the Issuer CSD and an Investor CSD

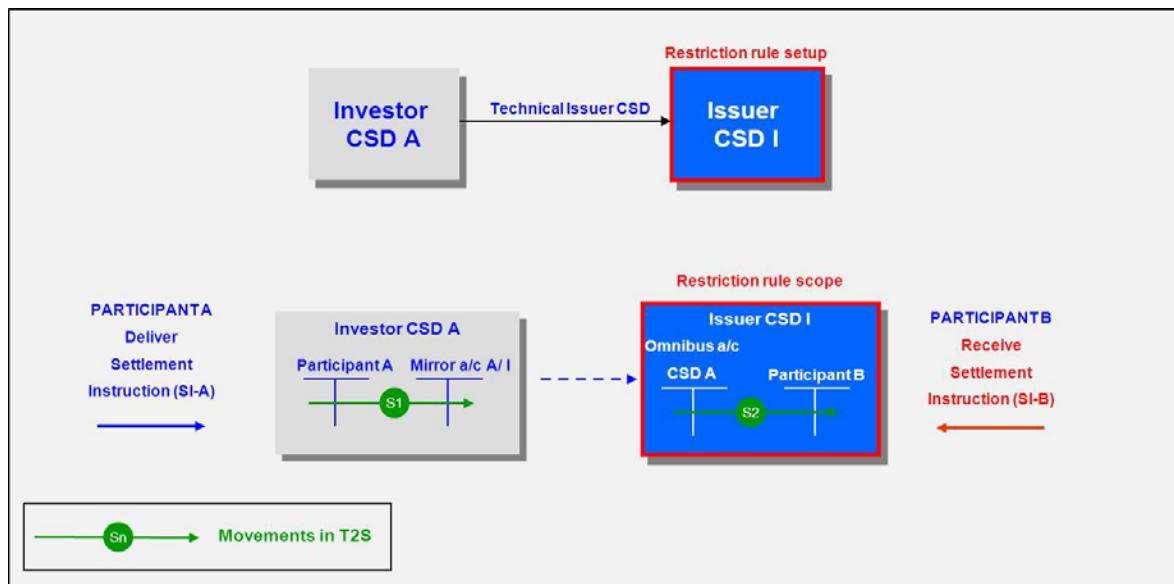

In this case, SI-A is outside the scope of the restriction rule setup by the Issuer CSD, but SI-B will be affected by the rule.

³² Following message is provided to the Investor CSD: Business Validation Rule SPRC006: “Business Instruction is cancelled because validation of one of the realignment instructions has failed”. The XMAP will discuss whether a CR should be envisaged for a further release of T2S to refine the information provided to Investor CSDs in such scenario

Since this is a cross-CSD transaction between the Issuer and Investor CSD, T2S will generate settlement instructions after successful matching to build the realignment chain and debit/credit the correct omnibus and mirror accounts.

The restriction rule setup at the Issuer CSD may impact the settlement transaction and underlying settlement instructions differently depending on the rule type, as shown in the table below:

Table 8 - Impact of restriction rules on cross-CSD involving the Issuer CSD and an Investor CSD

Restriction rule defined at Issuer CSD	Impact on settlement instructions
Case 1: Rejection (settlement instruction)	SI-A will have status “Unmatched” SI-B will have status “Rejected” T2SgSI will not be generated If SI-A and SI-B are matched when the restriction rule is triggered (e.g. applies on the realignment instructions) SI-A will have status “Matched” then “Cancelled” due to cancellation of the T2SgSI SI-B will have status “Matched” then “Cancelled” due to cancellation of the T2SgSI T2SgSI will have status “Matched” then “Cancelled”
Case 1: CSD Validation Hold (settlement instruction)	SI-A will have status “Matched” and Settlement status “Pending” (Reason code PRCY, status sent on Intended Settlement Date) SI-B will have status “Matched” and Settlement status “Pending” (Reason code CVAL, status sent upon validation of the SI in T2S) T2SgSI will have status “Matched” and Settlement Status “Pending” (Reason code LINK, status sent on Intended Settlement Date)
Case 2: Blocking (security, account, party)	SI-A will have status “Matched” and Settlement status “Pending” (Reason code SBLO/BLOC, status sent on Intended Settlement Date) SI-B will have status “Matched” and Settlement status “Pending” (Reason code SBLO/BLOC, status sent on Intended Settlement Date) T2SgSI will have status “Matched” and Settlement Status

Restriction rule defined at Issuer CSD	Impact on settlement instructions
	“Pending” (Reason code SBLO/BLOC, status sent on Intended Settlement Date)
Case 3: Position Type complemented by a rejection (case 1) on the position type	<p>if SI-B is credited into earmarked position (RECE movement type)</p> <p>or if SI-B debited from blocked/reserved/earmarked position (if scenario was a DELI movement type)</p> <p>SI-A will have status “Unmatched”</p> <p>SI-B will have status “Rejected”</p> <p>T2SgSI will not be generated</p>

Scenario 3: Cross-CSD transaction involving two Investor CSDs where realignment between omnibus accounts does not take place at the Issuer CSD

This scenario covers a securities delivery between participants of different Investor CSDs, which do not have a direct link to the Issuer CSD (the Issuer CSD is not defined as their Technical Issuer CSD in T2S), while the restriction rule has only been setup at the Issuer CSD.

Figure 6 - Cross-CSD transaction involving two Investor CSDs where realignment between omnibus accounts does not take place at the Issuer CSD

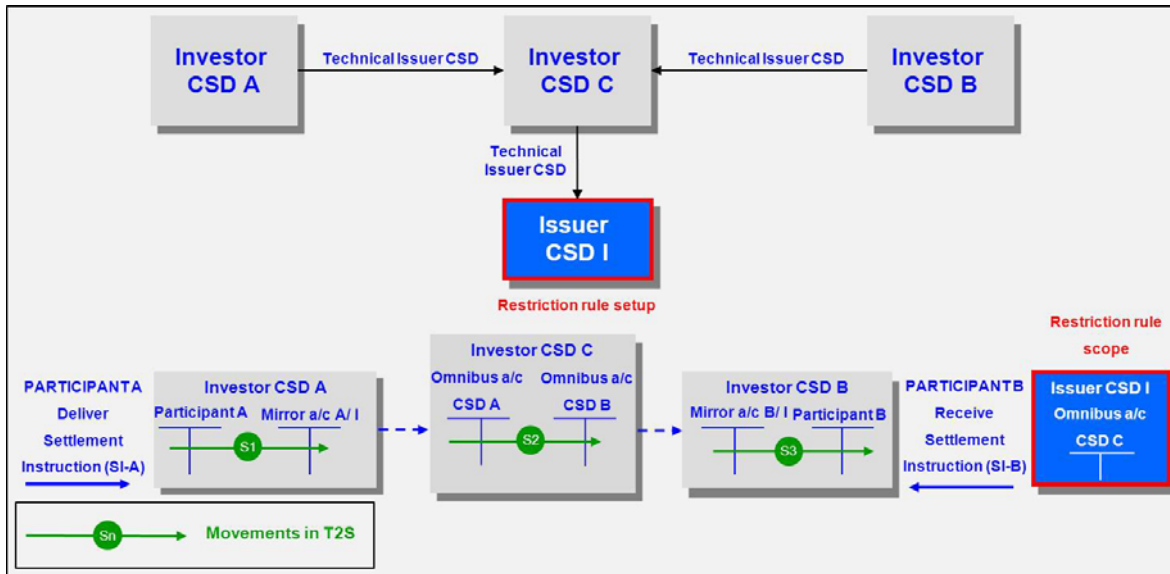

SI-A and SI-B are outside the scope of the restriction rule setup by the Issuer CSD.

Since this is a cross-CSD transaction between Investor CSDs, T2S will generate settlement instructions (T2SgSI) after successful matching to build the realignment chain and debit/credit the correct omnibus and mirror accounts.

However, in this specific scenario, this does not involve any settlement movement at the Issuer CSD.

As a result, any restriction rule setup at the Issuer CSD will not have any impact on the settlement transactions between Investor CSDs, as shown in the table below:

Table 9 - Impact of restriction rules on cross-CSD transaction involving two Investor CSDs where realignment between omnibus accounts does not take place at the Issuer CSD

Restriction rule defined at Issuer CSD	Impact on settlement instructions
Case 1: Rejection (settlement instruction)	SI-A, SI-B, and T2SgSIs will not be affected and transaction may settle
Case 1: CSD Validation Hold (settlement instruction)	SI-A, SI-B, and T2SgSIs will not be affected and transaction may settle
Case 2: Blocking (security, account, party)	SI-A, SI-B, and T2SgSIs will not be affected and transaction may settle
Case 3: Position Type complemented by a rejection (Case 1) on the position type	SI-A, SI-B, and T2SgSIs will not be affected and transaction may settle

Scenario 4: Intra-CSD transaction at Investor CSD

This scenario covers a securities delivery between participants of the same Investor CSD, while a restriction rule has been setup at the Issuer CSD. The assumption is that both participants in the Investor CSD are mapped to the same omnibus account at the Issuer CSD. When this is not the case, the impacts on a rule defined at the Issuer CSD on an intra-CSD transaction at the Investor CSD will be as described in Scenario 1.

Figure 7 – Intra-CSD transaction at the Investor CSD

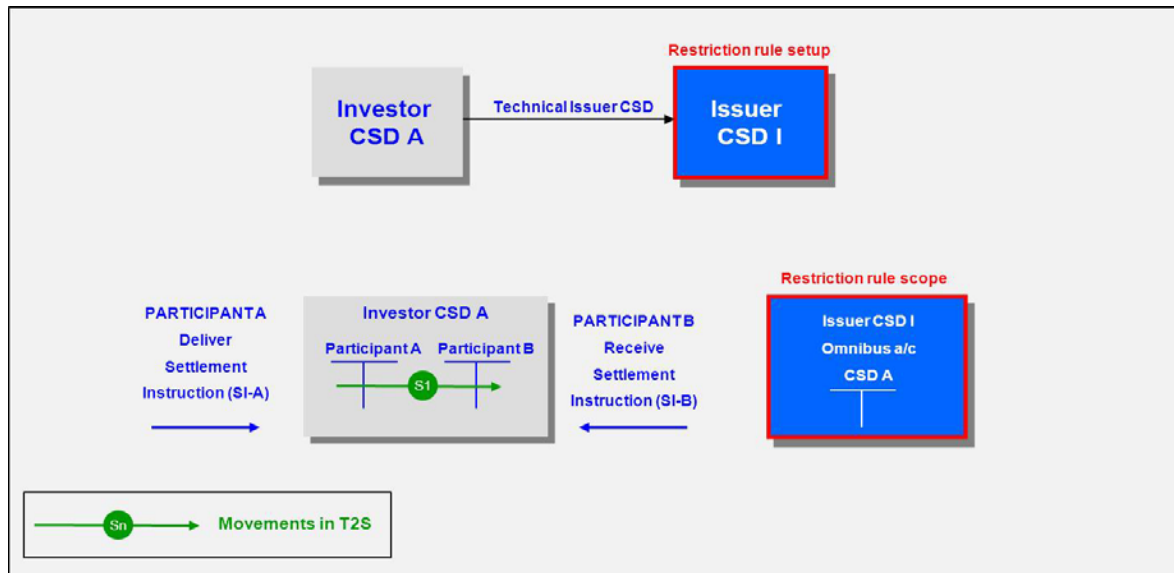

SI-A and SI-B are outside the scope of the restriction rule setup by the Issuer CSD.

Furthermore, since this is an intra-CSD transaction at the Investor CSD, T2S does not generate any realignment instructions and all securities movements take place between the Investor CSD’s participants’ accounts.

As a result, any restriction rule setup at the Issuer CSD will not have any impact on the settlement transaction at the Investor CSD as shown below:

Table 10 - Impact of restriction rules on intra-CSD transaction at the Investor CSD

Restriction rule defined at Issuer CSD	Impact on settlement instructions
Case 1: Rejection (settlement instruction)	SI-A and SI-B will not be affected and transaction may settle
Case 1: CSD Validation Hold (settlement instruction)	SI-A and SI-B will not be affected and transaction may settle
Case 2: Blocking (security, account, party)	SI-A and SI-B will not be affected and transaction may settle
Case 3: Position Type complemented by a rejection (Case 1) on the position type	SI-A and SI-B will not be affected and transaction may settle

3.2.2 Potential Complexities linked to Rules Propagation

Propagation of rules refers to the scenario in which an Investor CSD implements restriction rules based on the restriction rules defined by the Issuer CSD.

The analysis of the potential impacts of restriction rules on cross-CSD settlement flows illustrates that Investor CSDs may need to propagate some rules in order to have a consistent behaviour with regards to the lifecycle of their settlement instructions and their service offering.

However, CSDs also have to consider the complexities inherent to the increased number of rules and their implementation. The propagation of rules and MSAs is not always a trivial copy and paste of the restriction rules defined by the Issuer CSDs, but could be in some cases a much more complex exercise. Indeed, each Investor CSD may have defined its own restriction rules for a specific business process, and on top, have to implement rules from one or several Issuer CSDs for the same business process. This might potentially require substantial effort on “translation” and combination of rules and parameters values, resulting in increased complexity for Investor CSDs.

In addition, if MSAs are used in the rules (e.g. as restriction rule parameters), the propagation of the rules from the Issuer to the Investor CSDs may also lead to the propagation of MSAs, and when the Investor CSD has also defined an MSA for the same object, rules parameter values could need to be combined in order to control the expected outcome of rules. This could lead to an increase in the number and complexity of MSAs, as well as in the configuration of the rules using these MSAs. [According to the feedback provided by some CSDs at the time of writing, such problem has not been encountered so far].

While the implementation of restriction rules as Issuer or Investor CSD should be driven by the need to implement a control related to a specific business process (so that the behaviour of T2S is in sync with the intended business objective), the impacts of setting restriction rules and MSAs on cross-CSD settlement flows and configuration of static data must be carefully assessed, and there is a need for CSDs to understand the rules of other CSDs, in order to control the effects of a rule on their participants.

3.3 Conditional Securities Delivery (CoSD)

CoSD is a T2S functionality which allows coordinated settlement of a transaction based on the fulfilment of a settlement condition outside T2S, e.g. a CSD can coordinate a FOP delivery in T2S with a cash settlement outside T2S on behalf of its participants.

In order to use conditional settlement, a CSD needs to define a set of rules in static data based on a set of parameters and values, like restriction rules. On Intended Settlement Date prior to the settlement eligibility check³³, settlement instructions fulfilling the conditions defined in the CoSD rule will be automatically put on hold (CoSD Hold) and securities and/or cash (as defined with the rule parameters) will be blocked into a specific sub-position³⁴. The instructions will have to be released by one or several predefined Administering Parties, or cancelled.

The CoSD functionality is tailored for scenarios where the depository is external to T2S, or where the currency is not eligible for settlement in T2S. Similarly to restriction rules, CoSD rules are also checked

³³ After matching and generation of realignment instructions in case of cross-CSD transactions

³⁴ The “COSP” position type will be created by the T2S Operator and available to all the CSDs’ securities accounts

against T2S Generated Realignment Instructions, and may therefore impact Investor CSDs' settlement flows.

3.4 Segregation Models

Segregation Models prior to T2S

CSDs are using segregation of securities positions in different contexts due to the specificities of the business process, market practices, or regulatory requirements and have defined rules and procedures based on these segregated positions, inter alia:

- To restrict the CSD participants from using securities positions pending registration
- To prevent the CSD participants from using securities positions set aside in the context of an elective CA

Various segregation models are implemented by CSDs, according to national specificities, service offering, and market practices favoured by CSD participants. A non-exhaustive list of segregation models used by CSDs is described below.

Account segregation model

Segregation can be implemented using distinct securities accounts at the CSD. The CSD opens and maintains multiple accounts for each of its participants. Accounts are qualified by using account level attributes to identify the purpose of the account. The diagram below illustrates a segregation model using separate accounts:

Figure 8 - Example of account segregation model

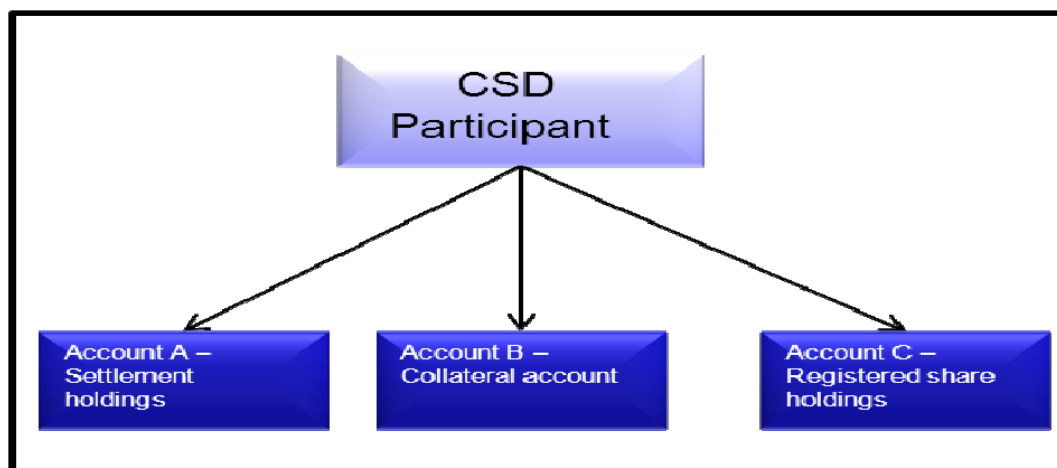

One of the most prevalent variations of the account segregation model is the main account/sub-account structure. In this model, each securities account held by a CSD participant is composed of a main account and one or more sub-accounts. The securities positions held in the main account are used by default for settlement of transactions, whereas the holdings in sub-accounts represent positions set aside for a specific purpose. The CSD configures sub-accounts either on a mandatory basis, e.g. when imposed by regulatory requirements, or upon request of its participants, for the provision of specific services. The

sub-accounts are always identified along with the main account. The diagram below illustrates a segregation model using main/sub accounts:

Figure 9 - Main/Sub account structure at Clearstream³⁵

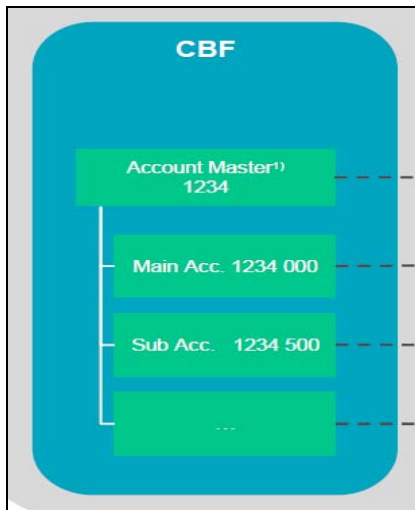

Position type segregation model

Segregation can also be achieved by splitting securities positions of an account into two or more sub-positions, also commonly referred as position types. The terminology of these position types varies across markets, inter alia 'Account nature' (ESES), or 'situation' (Interbolsa). The diagram below illustrates a segregation model using position types:

Figure 10 - Example of position type segregation model

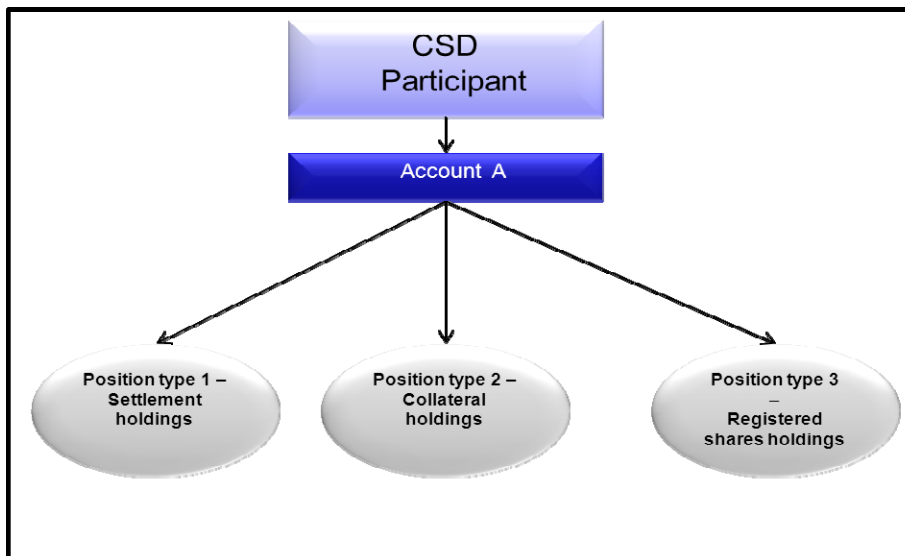

³⁵ Adapted from the document 'CBF_t2s_basic_presentation_english.pdf' from Clearstream Banking Frankfurt (CBF) website: http://www.clearstream.com/ci/nonav/en/binary/ci_content_pool/attachements/01_settlement/025_csd_services/target2_securities/t2s_basic_presentation_english.pdf.

In a segregation model by position types, the CSD maintains a securities account for each participant. Distinct position types are configured within the same securities account to segregate securities positions for a specific purpose. Each position type is identified by a distinct code identifying the purpose for which the positions have been segregated.

Some CSDs use a combination of the segregation models described above. One main account is complemented with one or many sub-accounts and holdings within the sub-accounts are further segregated by using qualified position types. Several accounts can also be opened for a participant, each account being further segregated into position types.

Segregation Models in T2S

T2S supports segregation of holdings using separate accounts or using specific position types or a combination of both. CSDs have the option of choosing the account structure that best suits their existing business and operating model.

The diagram below illustrates the combined account structure achievable in T2S:

Figure 11 - Example of Combined Account structure in T2S

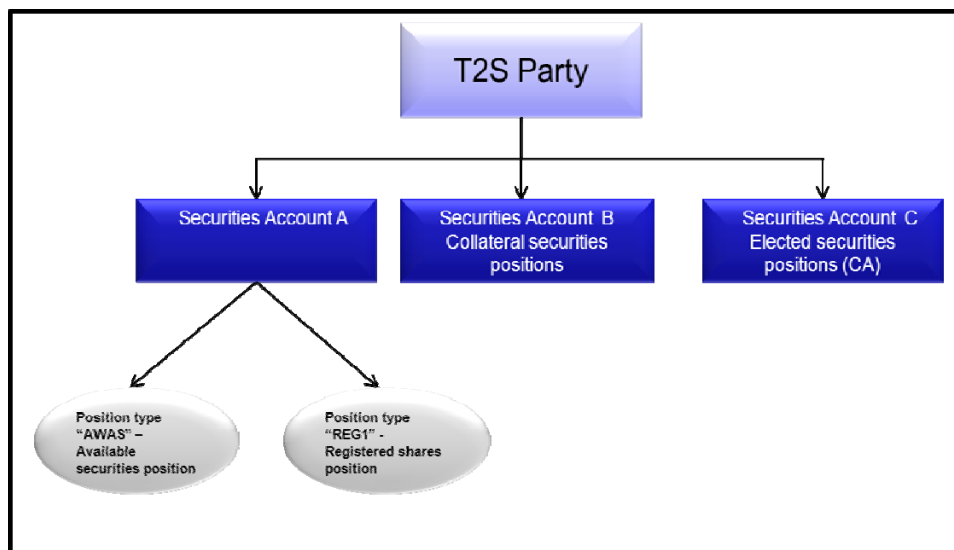

For the creation of position types within an account, T2S provides the following processing options for CSDs, referred as Case 3 Restriction Type.

Blocking

The process of blocking creates a blocked pool of securities position preventing the transfer of the blocked quantity of a security in one securities account to any other securities account by associating it to a specific identification to be used for specific purposes. The settlement of a settlement instruction using blocked securities results in the actual transfer of the blocked holdings to another securities account and

in the subsequent removal of the blocking. Settlement restrictions³⁶ that are used to setup blocking restriction types cannot settle partially.

Earmarking

Earmarking is the process of specifying that a certain quantity of a security in one securities account is only eligible for specific type of transactions or processes. Settlement restrictions used to setup earmarking position types can settle partially. Earmarking at the securities account level is also possible.

Reservation

Reservation prevents the transfer of a securities position in a specific security in one securities account to any other securities account except for the purpose for which the position was reserved. Settlement restrictions used to setup reservation restriction type can settle partially.

Please note that some position types are created directly by the T2S Operator, inter alia “COSD” blocking used in the context of Conditional Securities Delivery (CoSD) and “EEUR” used for earmarking in the auto-collateralisation process³⁷.

Impacts of using position types in T2S in a cross-CSD context

Segregation by position types can be seen as one of the implementation options to achieve segregation of securities positions, and depends on the operating model and market practices of the CSD. In the context of the present analysis, if position types defined by an Issuer CSD for a specific business service are applicable to its Investor CSD, segregation could be achieved by using position types within a securities account (Case 3 Restriction Type) or by using separate accounts depending on the implementation option of the Investor CSD in T2S, with different impacts in terms of rule setup, Market-Specific Attributes and reconciliation of securities positions. The increase in the number of segregated positions resulting from the implementation of a business process as Issuer or Investor CSD will lead to additional complexity in the account configuration.

For cross-CSD settlement, T2S generated realignment instructions do not reference any of the position types created by the CSD, except in the case of earmarking at the level of a securities account. Indeed, if the position types (Case 3 Restriction Type) rules defined by the Issuer CSD are applicable to the omnibus accounts of the Investor CSD, this could result in the segregation of Investor CSD positions within the omnibus account. In a cross-CSD scenario, a Business Instruction from a CSD participant of the Investor CSD could trigger the generation of realignment instructions by T2S at the Issuer CSD, debiting or crediting the omnibus account of the Investor CSD. But the realignment instructions generated by T2S on the omnibus accounts always reference the available position type (‘AWAS’) for delivery and receipt of the securities. Therefore, positions segregated by position types in an omnibus account will not be used by T2S for settlement of realignment instructions. This also implies that such segregated

³⁶ Intra-Position Movement and Intra-Balance Movement are Settlement Restrictions

³⁷ Please refer to Table 10 – Restriction Matrix in the UDFS 2.0 for an exhaustive list of Case 3 Restriction Type created by the T2S Operator

positions cannot be used directly for cross-CSD settlement, and must first be transferred to the available (AWAS) position. CSDs must take note of this and analyse if the segregation of the positions intends to restrict their usage in cross-CSD settlement.

As long as there are sufficient positions available in the ‘AWAS’ position type at the omnibus account, the realignment instruction and the corresponding delivering Business Instruction would settle successfully. The diagram below illustrates how position types are used in a cross-CSD transaction:

Figure 12 - Position types used in realignment instructions generated by T2S

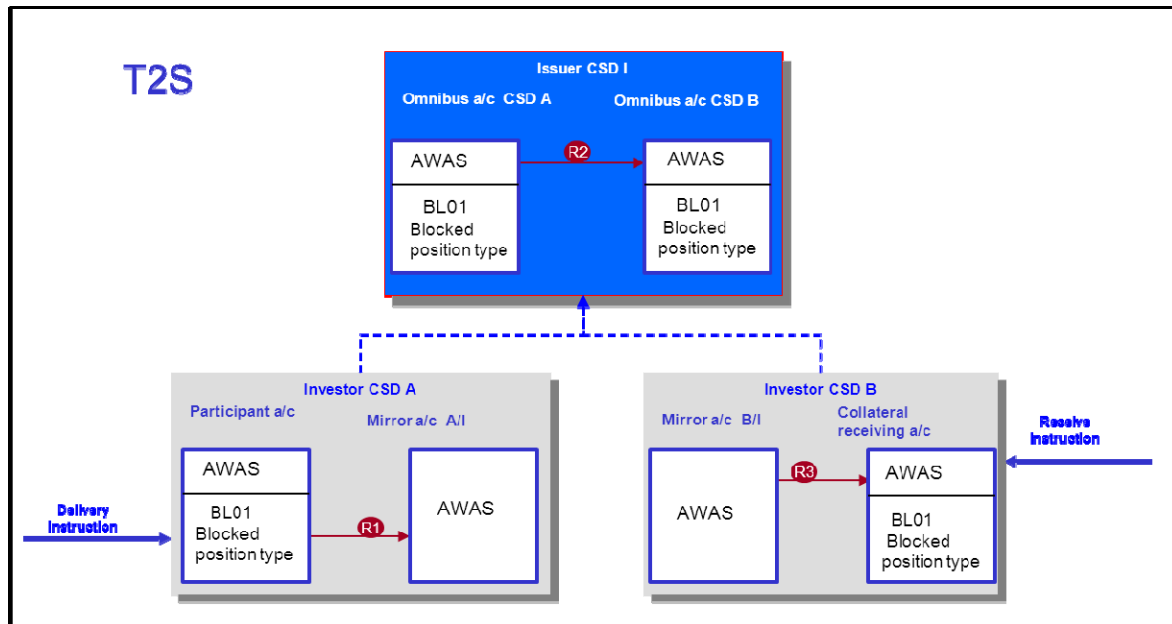

In the diagram above, Investor CSD A and Investor CSD B have opened omnibus accounts at the Issuer CSD I. The Issuer CSD has segregated the positions of the omnibus account using a blocking position type BL01. The Investor CSDs have also used a similar blocking position type BL01 in their respective participant accounts to segregate the positions.

Participant of Investor CSD A instructs to deliver securities to a participant of Investor CSD B debiting the securities from blocked position type in his securities account. Since realignment instructions generated by T2S uses only AWAS positions in the omnibus account, the movement in the omnibus accounts of the Investor CSDs CSD A and CSD B uses AWAS position (movement R2 in figure 5). Also, in T2S it is not possible to indicate a blocked or reserved position type into which the received securities must be transferred. Therefore, segregated positions in the position type BL01 will not be used by T2S for settlement of realignment instructions.

In the scenario when the omnibus account itself is earmarked for a specific purpose, the available credit/debit position type (AWAS) is overridden by the earmarked position type. This has a number of consequences. First, the AWAS position type will not be available for settlement if the earmarking is at account level, but the realignment instructions will use the earmarked securities position which was previously in the AWAS. Consequently, any other rule (Case 1 or Case 2) restricting the usage of the

earmarked position type at the Issuer CSD may impact the realignment instructions. Second, an earmarked position type can be used in a cross-CSD transaction if both the delivering and receiving parties reference the earmarked position type and the omnibus account is earmarked. Note that, if the omnibus account is not earmarked, the transaction will still be able to settle, using the available position in the omnibus account.

4. Detailed Business Process Assessment

4.1 Corporate Actions

Introduction

For the assessment of restriction rules according to the methodology defined in Section 2.2 “Methodology to quantify impacts on Investor CSDs”, Corporate Actions is categorised as a necessary service from an Investor CSD’s standpoint. Indeed, CA servicing must be provided by the Issuer CSD for the securities that Investor CSDs hold in the books of the Issuer CSD.

A Corporate Action (CA) can be defined as an action initiated upon a security by the Issuer or an Offeror³⁸ based on events occurring during the lifecycle of that security, either predefined at the creation of the security (like a coupon payment, or final redemption date for bonds), or decided during the lifecycle of the security by the company’s board of directors and approved by its shareholders (like the provision of a dividend for a stock, or a merger).

CA events are classified in the following categories as per the CAJWG standards:

CA on stock, applied on settled positions:

- Distributions:
 - Cash Distributions (e.g. cash dividend, interest payment)
 - Securities Distributions (e.g. stock dividend, bonus issue)
 - Distributions with Options
- Reorganisations:
 - Mandatory Reorganisations with Options (e.g. conversion)
 - Mandatory Reorganisations (e.g. stock split, redemption)
 - Voluntary Reorganisations (e.g. tender offer)

CA on flows, applied on pending transactions³⁹:

- Transaction Management
 - Market Claims (Distributions)
 - Transformations (Reorganisations)

³⁸ Glossary of the Market Standards for Corporate Actions Processing developed by Corporate Action Joint Working Group (CAJWG)

³⁹ In some scenarios, also on settled transactions (reverse market claims)

- Buyer Protection (Elective CA)

Listed below are the key dates affecting CA processing according to the CAJWG standards⁴⁰:

- Announcement by Issuer: Date on which a CA is publicly announced and the Issuer CSD is informed accordingly by the Issuer (or Offeror).
- Record Date: Date on which settled positions are struck in the books of the Issuer (I)CSD at close of business to determine the entitlement to the proceeds of a CA.
- Ex-Date⁴¹: Date from which the Underlying Security is traded without the benefit / right attached to it.
- Last Trading Date⁴²: the last date to trade the Underlying Security in the old ISIN in the case of Mandatory Reorganisations.
- Payment date: Date on which the Payment is due.

In the case of elective CA (Distributions with Options, Mandatory Reorganisations with Options and Voluntary Reorganisations), the following dates must be considered:

- Start of Election Period: Start of the period during which elections can be made.
- Guaranteed Participation Date: Last date to buy the Underlying Security with the right attached to participate in an Elective Corporate Action.
- Buyer Protection Deadline: Last day and time by which a Buyer Protection instruction can be given.
- Market Deadline: Last date and time, preferably end of day, to send election instructions to the Issuer (I)CSD.

Prior to T2S, all components of CA processing are managed by the CSDs. In this context, the settlement of CA is performed on the CSDs' legacy systems and integrated in the schedule of the settlement day in order to ensure precedence over trade-related instructions, after the entitlement has been calculated.

As a general rule, entitlement calculation and generation of CA related settlement instructions are performed at the end of record date while settlement is inactive. In most markets, CA related settlement instructions are processed in a dedicated settlement cycle, and scheduling ensures that CA settlement is completed before triggering the settlement cycle for other transactions. In some specific situations, CA settlement is sometimes performed outside normal processing schedule, inter alia on weekends. Some CSDs submit CA related settlement transactions with a higher priority in the settlement engine.

⁴⁰ For the sequence of dates and timeline, please refer to the CAJWG standards which include the respective diagrams for all CA categories

⁴¹ Note that the Ex Date is not applicable to securities in nominal, e.g. bonds

⁴² This restriction only applies to Stock Exchange trades and not OTC trades

Settlement of CA is based on a cascading process for the delivery of proceeds, starting from the Issuer CSD downward the chain of intermediaries (including Investor CSDs and Custodians) up to the end Investor:

- For cash proceeds, the distribution is done via a Paying Agent appointed by the Issuer
- For securities proceeds, securities are created by the Issuer CSD and distributed to its participants, including Investor CSDs, based on instructions received from the Issuer; in turn, Investor CSDs have the responsibility to distribute the proceeds among their participants

As a result, the processing of CA on stock only generates intra-CSD settlement transactions, and there is a dependency to be taken into account in terms of timings for the distribution of proceeds, especially for Investor CSDs.

In addition, some CSDs put in place further controls to ensure CA processing is performed adequately and without interference with other settlement processes:

- By segregating positions affected by CA, these are transferred into a specific account or into a sub-position. This process is mainly used for elective CA.
- By blocking or rejecting all settlement instructions on an ISIN during the application of CA, in order to ensure positions are not affected by trade-related transactions. This process is mainly used for Reorganisations.

Note that the market CA standards⁴³ mandate that no blocking of holdings should be performed for the purpose of Cash Distributions.

The nature of controls put in place varies according to the CA category, but also to local market practices and regulatory requirements.

With migration to T2S, CA notification, entitlement calculation, generation of CA related settlement instructions as well as reporting will continue to be performed by the CSDs in their legacy systems. However, settlement instructions resulting from CA will be sent to T2S for settlement.

CA related settlement instructions will be handled in the T2S schedule during Night-Time Settlement (NTS) as follows⁴⁴:

- Instructions related to CA on stock will be eligible for settlement as from sequence 1 of the first NTS cycle, and in all cycle/sequences of the night time settlement thereafter. In contrast, settlement instructions resulting from trading activity are only eligible for settlement from sequence 4 of the first NTS cycle.

⁴³ CAJWG: Market Standards for Cash Distributions, standard 20

⁴⁴ CA related settlement instructions can also settle during Real Time Settlement but are not prioritised in the settlement engine at first settlement attempt. For further information, please refer to the UDFS v2.0 in section “1.4.3.2 Settlement day high level processes”

- Instructions related to CA on flows will be eligible for settlement along with instructions resulting from trading activity as of sequence 4 of the first NTS cycle.

In addition to being eligible in earlier sequences of NTS, CA-related settlement instructions may be configured by CSDs to be treated with “Reserved priority”, to achieve higher level of prioritisation in the T2S settlement engine.

The cascading process for the delivery of CA proceeds, while facilitated by the migration to a common platform, will remain and the underlying dependencies must be taken into account for the scheduling of CA processing.

CSDs will implement restriction rules in T2S, based on static data in T2S or MSAs, to replicate the controls they have in place for CA processing, inter alia in the following contexts:

- To restrict the usage of specific accounts to specific parties in the context of CA processing
- To temporarily block settlement instructions on an ISIN affected by a CA event until the CA is fully applied on the affected securities accounts (only CA settlement is allowed, recognised by use of ISO transaction code). These rules will be widely used by CSDs in the context of Reorganisations
- To segregate securities position into a specific position type, then restrict (with Restriction Type 1) the usage of these position types for CA processing, which only the CSD can debit/credit

As opposed to many other business processes in the context of this analysis, the application of CA is a necessary process to be performed by each Investor CSD as part of standard customer asset servicing. The impact analysis must take into account the need for replication at Investor CSDs in intra-CSD scenarios⁴⁵, for inter alia the application of CA on stock.

The description of current controls, restriction rules and impact analysis by market is detailed in the next sections. Please note that for those CSDs that have not defined restriction rules for the processing of CA an explanation is given. The purpose of this so-called “Sanity Check”⁴⁶ is to confirm to the T2S community that all CSDs have a common understanding of the tools they can use to control settlement in T2S, while ensuring a fair application of the methodology based on accurate and exhaustive information.

4.1.1 Baltic CSDs

Pre T2S – Process Controls

Prior to T2S, the Baltic CSDs (Estonia, Latvia, and Lithuania) have put in place adequate controls on their legacy platforms for CA processing, including the handling of elective CA.

Adapted State – Process Controls

⁴⁵ And cross-CSD scenarios which do not involve realignment movements at the Issuer CSD

⁴⁶ During the ad-hoc CSG meeting held on 29 July 2015, the CSG adopted the proposal by the T2S Programme Manager to perform the so-called “Restriction Rules Sanity Check” for those cases where a majority of CSDs have defined restriction rules for a business process while other CSDs plan to implement this process without restriction rules in T2S (in particular in the context of Corporate Actions and Insolvency Procedures).

The Baltic CSDs plan to define the following restriction rules in the context of elective CA processing:

Rejection (Case 1 Restriction Type):

BCDR05: a positive rejection rule to reject all settlement instructions sent by CSD participants debiting the “CABL” sub-position.

The parameters configured in this rule are listed below:

- Debited Position/Balance, with value:
 - CABL
- Party Type (of the instructing party), with value:
 - CSD Participant

Blocking (Case 3 Restriction Type):

CABL: blocking of securities positions in the context of elective CA.

Cross-CSD Impact Analysis

Impact on Investor CSD account configuration

The rule “BCDR05”, along with the position type “CABL”, are defined for elective CA in order to block elected securities into the “CABL” position type, and to restrict access to this position. This segregation is applicable to the Investor CSD omnibus account. Investor CSDs must also apply segregation on the securities accounts of their participants, to block the elected positions, but can choose to segregate the positions into position types or into separate accounts.

Impact on Investor CSD settlement flows

The rule “BCDR05”, along with the position type “CABL”, will not impact trade-related cross-CSD transactions since only the securities in the available position (“AWAS” Position Type) will be used by T2S generated Realignment Settlement Instructions. It is only in the case of a cross-CSD transaction where a participant of the Baltic CSDs tries to deliver from the blocked position to a participant of another CSD that the rule would be triggered. It would also be the case if an Investor CSD would try to debit directly the blocked position in the omnibus account (this should not happen in normal business scenarios). Investor CSDs should ensure to prevent settlement of elected securities positions in their books for trade-related transactions by restricting access to the segregated securities positions.

4.1.2 BOGS

The only corporate actions events currently applicable on securities traded in BOGS are the coupon payment and the full redemption (CA Reorganisations are not applicable for BOGS). Blocking of an ISIN is therefore not required, since at the redemption date, all pending instructions on the relevant ISIN will be automatically cancelled by T2S during the revalidation process at the start of day.

4.1.3 CDCP

Pre T2S – Process Controls

Processing of Corporate Actions in CDCP is currently limited to Reorganisations (securities static data change) and Redemptions. Distributions of potential proceeds stemming from Redemptions are managed by the respective Issuer or his agent, CDCP is not involved in this process.

Currently Corporate Actions instructions are processed during real time settlement. Being aware it is not in line with CA and T2S processing standards, CDCP's intention is to introduce the necessary changes in operational procedures with the aim of sending CA instructions to night time settlement.

The Slovakian Law provides the option to Issuers to restrict settlement of securities in certain scenarios:

- Maximum 5 days prior a General Meeting, shares can be blocked for settlement at the request of the Issuer. This process only applies to illiquid securities, not traded on a Stock Exchange.
- In case of redemptions (or theoretically any other CA if deemed necessary), the Issuer has the possibility to request suspension of settlement in the impacted ISIN. The period for which the suspension should apply is defined by the Issuer.

Such suspension from settlement shall not apply to transactions stemming from inheritance claims.

Note: CDCP has initiated discussion with local Regulators in order to try and remove such restrictions, being aware that these practices may not be in line with European standards.

Adapted State – Process Controls

CDCP plans to implement restriction rules for CA processing in T2S in order to be able to temporarily suspend settlement in an ISIN if requested by the issuer:

- “RSE1” a negative Case 2 Restriction Type rule, will be defined to temporarily block settlement instructions on an ISIN, maximum 5 days prior a General Meeting at the request of the Issuer.
- “RSE2” a negative Case 2 Restriction Type rule, will be defined to temporarily block settlement instructions on an ISIN undergoing a Corporate Action, generally used for redemptions, at the request of the Issuer. The validity period of this restriction will be defined by the Issuer.

For both restrictions, during the period for which the blocking is activated, no settlement will be allowed, except for settlement instructions sent by CDCP with the ISO transaction code “TRAD”: such exceptions will be used for transactions stemming from inheritance claims that must not be submitted to the restrictions. In addition, for “RSE2”, the following ISO transaction codes will allow to bypass the rule, for the purpose of processing Corporate Actions instructions: “CORP”, “REDI”, “ISSU”. The parameters used in the context of these rules are:

- Instructing Party: CDCP's BIC

- Transaction type code: “TRAD”, “CORP”, “REDI”, “ISSU”⁴⁷

Cross-CSD Impact Analysis

Impact on Investor CSD account configuration

The restriction rules “RSE1” and “RSE2” do not rely on account configuration parameters and do not involve account segregation, therefore no impact is foreseen on Investor CSDs’ account configuration.

Impact on Investor CSD settlement flows

The restriction rules “RSE1” and “RSE2” will impact any cross-CSD settlement transaction involving realignment movements at CDCP. As a result, no settlement will take place on the ISIN subject to blocking while the restriction rule is active, and an Investor CSD’s Business Settlement Instruction will be matched but “Pending” for settlement.

However, the rules defined by the Issuer CSD will not prevent intra-CSD settlement of trade-related transactions at Investor CSDs. Since these restrictions are applied on request of the Issuer and that this is foreseen by a national regulatory requirement, it is expected that the rules will need to be implemented by Investor CSDs.

4.1.4 Clearstream Banking Frankfurt (CBF)

Pre T2S – Process Controls

A specific cycle is dedicated for settlement of CA on stock at the start of the settlement day. In addition, for elective CA, securities positions are segregated into the participants’ sub-accounts. No blocking is performed at the level of the ISIN in case of Reorganisations (due to the scheduling which ensures CA processing is completed before trade-related settlement can take place).

Adapted State – Process Controls

Clearstream has defined “Security blocking”, a negative blocking (Restriction Type 2) rule, for management of CA. The restriction rule will be used to temporarily block settlement on an ISIN affected by a CA event until the CA is fully applied on all the affected securities accounts. During this period, only CA settlement is allowed on the ISIN, recognised by the ISO transaction code “CORP” included in the settlement instruction, which refers to CA on stock. The usage of this transaction code is controlled by privilege and will not be available to CSD participants. After all relevant CA instructions have been settled, the restriction on the ISIN will be removed so that regular trade-related settlement can resume.

According to Clearstream’s documentation⁴⁸, the selective blocking of securities might be activated when processing the following CA event types (Reorganisations): Redemptions, Redemptions in securities,

⁴⁷ The parameters “CORP”, “REDI”, “ISSU” will be added in the next version of the Reference Data Extension.

⁴⁸ An introduction to T2S for CBF customers October 2013

Reclassification, Conversion of Shares, Capital Decrease, Merger, Pari-Passu, Reverse Stock Split, Series-/Group Split, Intermediates to Lead Manager.

No restriction rules will be put in place for the processing of elective CA.

Cross-CSD Impact Analysis

Impact on Investor CSD account configuration

The restriction rule “Security blocking” does not rely on account configuration parameters and does not mandate account segregation at the Issuer CSD, therefore no impact is foreseen on Investor CSDs’ account configuration.

Impact on Investor CSD settlement flows

The restriction rule “Security blocking” will impact any cross-CSD settlement transaction involving realignment movements at Clearstream on the ISIN(s) subject to blocking. As a result, for such transactions, no settlement will take place on these ISINs while the restriction rule is active, and an Investor CSD’s Business Settlement Instruction will be matched but “Pending” for settlement with the “security blocked” reason code (see the Section 3.2.1 for additional details).

However, the rule “Security blocking” will not prevent intra-CSD settlement of trade-related transactions at Investor CSDs. Depending on the CA event, the rule will need to be implemented by Investor CSDs in order to ensure the consistency of securities positions; for instance, in case of Partial Redemptions, while the CA is being applied on the omnibus account of Investor CSDs in the Issuer CSD, Investor CSDs must also ensure that underlying participants’ securities positions to be affected by the CA are not being used for trade-related transactions. At present, the selective blocking of securities is planned to be activated for the processing of the CA event types mentioned within the description of the “Adapted State – Process Controls”.

Another variable to take into consideration by CSDs in the context of CA involving a change of ISIN (which is mandated for all Reorganisations⁴⁹ according to the CAJWG standards) is the maturity/expiry date of an ISIN in T2S. In some cases, the maturity date of the ISIN can be used as an effective way to prevent settlement between participants in the underlying security after Record Date, and de facto reduce the need to define restriction rules⁵⁰.

Indeed, T2S validates settlement instructions based on the maturity/expiry date of the security in T2S static data. When T2S receives a settlement instruction from a CSD participant, T2S will reject the instruction if the intended settlement date of the settlement instruction is equal to or greater than the maturity/expiry date of the ISIN or if the date on which the CSD participant submits the settlement instruction is equal to or greater than the maturity/expiry date of the security. Furthermore, any update of

⁴⁹ Except in the case of Partial Redemptions

⁵⁰ This supposes that the maturity/expiry date of a security is defined as Record Date +1 business day, as recommended by the CASG.

the maturity/expiry date of the security triggers an automated intraday revalidation of settlement instructions in T2S. Note that this business validation rule does not apply to settlement instructions for which CSDs are Instructing Parties. This allows CSDs to do the necessary bookings on the securities accounts of their participants with regards to processing of a CA event on the underlying ISIN on or after the maturity/expiry date of that ISIN – for example processing of redemption of a bond on the maturity date by Issuer and Investor CSDs.

4.1.5 Depozitarul Central

Pre T2S – Process Controls

Today, CA processing in Depozitarul Central's legacy systems is only partially following the European CA standards and a clear comparison between the CA processing on the legacy platform and T2S is difficult to perform. There is no prioritisation of CA instructions compared to trade-related instructions in the settlement engine, but CA are processed according to a distinct time-frame (outside the regular settlement schedule) as well as sub-system (i.e. Registry System) for the Romanian securities. CA on foreign securities can be processed during the whole settlement day, on the securities account of Depozitarul Central's participants. During the application of some Reorganisations (e.g. Redemptions), blocking is performed at the level of the ISIN. As for the elective CA process, it is managed at issuer (agent) level and does not require Depozitarul Central to perform segregation at the level of the participants.

Adapted State – Process Controls

Depozitarul Central has defined the following restriction rules for management of CA:

- “RT04DC”, a positive rejection (Case 1 Restriction Type) rule. The rule will be defined to reject settlement instructions submitted by CSD participants (Instructing Party) acting as Directly Connected Parties (DCPs), and using the ISO transaction codes “CORP”, or “CLAI”, which Depozitarul Central uses for submitting CA-related settlement instructions. Note that the usage of ISO transaction codes can also be restricted with appropriate configuration of access rights⁵¹, and therefore alleviate the need for a restriction rule. However, this requires a certain granularity in the definition of users. No MSA is created in the context of this rule.
- “RT05DC”, a negative blocking (Case 2 Restriction Type) rule. The rule will be defined to temporarily block settlement on an ISIN affected by a CA event until the CA is fully applied on all the affected securities accounts. During this period, only CA settlement is allowed on the ISIN, recognised by the “CORP” ISO transaction code included in the settlement instruction. After all relevant CA instructions have been settled, the restriction on the ISIN will be removed so that regular trade-related settlement can resume.

⁵¹ A specific privilege must be granted for a user to be authorised to send a settlement instruction with a specific ISO transaction code.

At present, Depozitarul Central does not plan to setup restriction rules to handle elective CA, as there are only limited events requiring elections, and the process is managed by Issuers or Issuers' Agents.

Cross-CSD Impact Analysis

Impact on Investor CSD account configuration

The rules "RT04DC" and "RT05DC" do not rely on account configuration parameters, and do not involve account segregation therefore no impact is foreseen on the Investor CSD account configuration.

Impact on Investor CSD settlement flows

The restriction rule "RT04DC" will reject settlement instructions that include the ISO transaction codes "CORP" or "CLAI" and instructed by CSD participants (Instructing Party). The rule will not impact T2S generated Realignment Instructions as these will always include the "REAL" ISO transaction code:

- In case of a cross-CSD transaction between a participant of Depozitarul Central whose Business Instruction is matching the rule parameters and a participant of an Investor CSD, the Business Instruction in Depozitarul Central will be rejected while the Business Instruction in the Investor CSD will remain unmatched. No realignment for this transaction will be created.
- In other cross-CSD scenarios generating realignments at Depozitarul Central (i.e. between Investor CSDs' participants or a participant of Depozitarul Central and a participant of an Investor CSD), the realignment instructions will not be impacted by the rule as explained here above. This fulfils the expected behaviour in the scenario of a cross-CSD market claim where an Investor CSD would instruct one leg of the transaction. Realignments resulting from this transaction should not be rejected.

While it is expected that each CSD will need similar control for the use of CA related ISO transaction codes, their usage can be restricted with appropriate configuration of access rights. In such case, Investor CSDs do not need to implement a restriction rule.

The rule "RT05DC" will impact any cross-CSD settlement transaction involving realignment movements at Depozitarul Central in a similar way: no settlement will take place on the ISIN subject to blocking while the restriction rule is active, and an Investor CSD's Business Settlement Instruction will be matched but "Pending" for settlement (see the Section 3.2.1 for additional details).

However, the rule defined by Depozitarul Central will not prevent intra-CSD settlement of trade-related transactions at Investor CSDs. Depending on the CA event, the rule will need to be implemented by Investor CSDs in order to ensure the consistency of securities positions; for instance, in case of Partial Redemptions, while the CA is being applied on the omnibus account of Investor CSDs in the Issuer CSD, Investor CSDs must also ensure that underlying participants' securities positions affected by the CA are not being used for trade-related transactions. Depozitarul Central has not yet fully defined the scope of CA events for which the rule will be applied.

4.1.6 ESES (Euroclear Belgium, Euroclear France, Euroclear Netherlands)

Pre T2S – Process Controls

A specific processing cycle is dedicated for settlement of CA on stock at the start of the settlement day. Furthermore, securities positions affected by CA are segregated into separate accounts belonging to System Paying Agents (SPA) in the context of Mandatory Reorganisations and elective CA. Proceeds from CA are transferred from SPA accounts to participants' accounts. ESES has internal validation rules in place to define the compatibility between account types (Account Nature) and securities characteristics (Security Category, Security Legal Form, Security Holding Mode). These validations do not specifically apply in the context of CA processing, but are activated on a permanent basis and apply on every settlement instruction.

ESES has also put in place a specific control related to loyalty bonus shares/dividends provided to the holders of some French registered securities.

Adapted State – Process Controls

Based on validation rules currently in place, ESES has defined restriction rules to check the consistency between specific Account Natures (MSA) of securities account and specific Security Categories (MSA). The below rules relate to CA due to the category of the security:

- RT05 (ESE-019-COR), a positive rejection rule (Case 1 Restriction Type), will be implemented in order to reject settlement instructions on a 'Dematerialised drawing security', which are securities subject to redemption by drawing, using one of the following Account Natures as delivering or receiving account (in T2S, each Account Nature will be represented by a different securities account):
 - 'Bearer securities distributed to employees by their company' (004)
 - 'Registered securities (employees shareholding)' (008)
 - 'Securities to be distributed from stock distributions or after reorganisation' (020, 021, 022, 023, 024, 025, 026, 027, 028, 029)
 - Foreign companies securities presented for exchange offer or odd-lot offer' (050)
 - 'Coupons or rights to be paid in cash' (055)
 - 'Coupons or rights to be exchanged against securities' (056)
 - 'Shares of French nationalised companies that are presented for compensation' (059)
 - 'Underlying securities for certificates of deposit (Caisse nominative)' (061)
 - 'Subscription / redemption of funds' (062)
 - 'Local transfer agent on foreign securities' (064)
 - 'Shares delivered following conversion of bonds' (069)
 - 'Shares delivered after exercise of a stock option' (071)

- 'Total issued amount of stripped securities' (078)
- 'Coupon paid in non-Euro currency' (079)
- 'Foreign securities held by another CSD (foreign organisation or foreign custodian)' (080)
- 'TCN Issuing account' (092)
- 'Physical securities that are lost on non-dematerialised securities' (093)
- 'Physical securities with unknown owner' (094)
- 'Certificats représentatifs' physically held out of ESES CSD (095)
- 'Physical certificates out of traffic' (096)
- 'Specific NOMS for Belgian registered securities' (104)
- 'Blocked Securities' (107)
- RT05 (ESE-021-COR), a positive rejection rule (Case 1 Restriction Type), will be implemented in order to reject settlement instructions on a 'Redeemed drawing security' with an account nature equal to:
 - 'Bearer securities distributed to employees by their company' (004)
 - 'Registered securities (employees shareholding)' (008)
 - 'Fractional security proceeds to be presented for compensation' (018)
 - 'Securities to be distributed from stock distributions' (20,21,22,23,24,25,26,27,28,29)
 - The following Account Natures: (41,44,45,50,55,56,58,59,60,62,64,66,69,70,71,73,78,79, 80,86,92,94,95,96,101,104,105)⁵²
- RT05 (ESE-022-COR), a positive rejection rule (Case 1 Restriction Type), will be implemented in order to reject settlement instructions on a 'Entitlement/Right', which are temporary securities used in the context of Distributions with Options, using one of the following Account Natures as delivering or receiving account:
 - 'Administered registered securities' (001),
 - 'Broker trading accounts' (010),
 - 'Direct payment on registered securities' (016/017),
 - 'Bonds presented for conversion' (053),
 - 'Securities buyback by the issuer or funds redemption for domiciles' (057),
 - 'Shares of French nationalised companies that are presented for compensation' (059),

⁵² For the purpose of conciseness, Account Natures codes are listed here without the text description

- 'Underlying securities for certificates of deposit' (061),
- 'Total issued amount of stripped securities' (078),
- 'TCN issuing account' (092),
- 'Typical certificates out of traffic' (096)

ESES has defined restriction rules to check the consistency between specific Account Natures (MSA) of securities account and specific Security Holding Modes (MSA). The below rule relates to CA due to the nature of the account.

ESES has defined restriction rules to check the consistency between specific Account Natures (MSA) of securities account and specific Legal Forms of securities (MSA). The below rules relate to CA due to the nature of the account.

- RT07 (ESE-032-COR), a positive rejection rule (Case 1 Restriction Type), will be implemented in order to reject settlement instructions on securities with legal form 'bearer or registered', using the following Account Natures as delivering or receiving accounts:
 - 'Coupons or rights to be paid in cash' (55)
 - 'Coupons or rights to be exchanged against securities' (56)
- RT07 (ESE-38-COR), a positive rejection rule (Case 1 Restriction Type), will be implemented in order to reject settlement instructions on securities with legal form 'bearer', using the following Account Natures as delivering or receiving accounts:
 - 'Direct payment on registered securities without commission' (016)
 - 'Registered securities account excluded from direct payment' (017)
 - 'Registered securities issued from a corporate action currently being registered with the issuer' (045)
 - 'Foreign companies' securities presented for exchange offer or odd-lot offer' (050)
 - 'Reserved for NYSE Euronext for Tender offers' (066)
 - 'Interim securities paid in non-Euro currency' (079)

Finally, ESES has defined a restriction rule in the context of loyalty bonus shares/dividends eligible on some French securities. To retain their full rights, these loyalty bonus shares need to be registered and held during a certain period. During this lock-up period, they can only be transferred free of payment.

RT12 (ESE-058-COR) a positive rejection rule (Case 1 Restriction Type), will be implemented in order to reject settlement instructions against payment on specific ISIN codes (securities that have been registered and are eligible for loyalty bonus). The parameters used for the configuration of the rule are:

- Payment Type Code = APMT (against payment)
- Security: specifies the loyalty bonus ISIN codes

For the processing of elective CA, separate accounts with adequate privileges will be setup instead of restriction rules.

In practice, this process only affects a dozen of ISIN codes, therefore the implementation of an MSA has not been considered.

Cross-CSD Impact Analysis

Impact on Investor CSD account configuration

The below Account Natures are offered to Investor CSDs for their standard activity:

- 'Ordinary securities' (000) – default
- 'Administered registered securities' (001) – if requested to service registered securities of Euroclear France

For the rules RT05 (ESE-019-COR), RT05 (ESE-021-COR), RT07 (ESE-032-COR), RT07 (ESE-038-COR), no impact on Investor CSDs' account configuration has been identified, as none of the Account Natures triggering the rejection are available to Investor CSDs.

For the rule RT05 (ESE-022-COR), the Account Nature 'Administered registered securities' (001) may be held by Investor CSDs of Euroclear France⁵³, in order to be able to hold registered securities. 'Entitlement/Right' securities cannot be held by Investor CSDs on this Account Nature as this would trigger the rejection. These securities are used in the context of elective CA on stock, a process managed by each CSD distinctly. Investor CSDs, depending on their implementation of the elective CA process, will decide whether to replicate the MSAs (Account Nature – Security Category) relevant values and restriction rule. They must in all cases ensure, even in the case of intra-CSD transaction between 2 of their participants, that no 'Entitlement/Right' securities are transferred from an account mapped to the regular omnibus Account Nature 'Ordinary securities' (000) to an account mapped to the omnibus Account Nature 'Administered registered securities' (001), as this would translate into realignment instructions at Euroclear France triggering the rule.

The rule RT12 (ESE-058-COR) does not rely on account configuration parameters and does not involve account segregation, therefore no impact is on Investor CSDs' account configuration has been identified.

Impact on Investor CSD settlement flows

The rules RT05 (ESE-019-COR), RT05 (ESE-021-COR), RT07 (ESE-032-COR), and RT07 (ESE-038-COR) do not need to be replicated by Investor CSDs, as none of the Account Natures triggering the rejection are available to Investor CSDs:

- For a cross-CSD transaction between an ESES participant whose Business Instruction is matching the rule parameters and a participant of an Investor CSD, the Business Instruction of the ESES participant

⁵³The Account Nature 001 is not available to participants of Euroclear Belgium and Euroclear Netherlands

will be rejected while the Business Instruction of the Investor CSD will remain unmatched. No realignment will be created for this transaction.

- In other cross-CSD scenarios generating realignments at ESES (i.e. between Investor CSDs' participants or a participant of ESES and a participant of an Investor CSD), the realignment instructions will not be impacted by the rule and the transaction can be eligible to settle.

For the rule RT05 (ESE-022-COR), no cross-CSD transaction should take place as we are in the context of 'Entitlement/Right' securities (interim ISINs used for elective CA). Nevertheless, the rule would be triggered as follows if the Account Nature used in the transaction is 'Administered registered securities' (001):

- For a cross-CSD transaction between a participant of Euroclear France whose instruction is matching the rule parameters and a participant of an Investor CSD, the Business Instruction of the Euroclear France participant will be rejected while the Business Instruction of the Investor CSD will remain unmatched. No realignment will be created for this transaction.
- In other cross-CSD scenarios generating realignments at Euroclear France (i.e. between Investor CSDs' participants or a participant of Euroclear France and a participant of an Investor CSD), the rejection rule can be triggered on the realignment instructions, resulting in the Business Instructions being accepted, matched, then cancelled.

The restriction rule RT12 (ESE-058-COR) defined by ESES (and not implemented by Investor CSDs) would impact Investor CSDs' settlement flows as follows:

- For a cross-CSD transaction DVP between a participant of Euroclear France and a participant of an Investor CSD, the Business Instruction of the Euroclear France participant will be rejected while the Business Instruction of the Investor CSD will remain unmatched. No realignment will be created for this transaction.
- In other cross-CSD scenarios generating realignments at Euroclear France (i.e. between Investor CSDs' participants or a participant of Euroclear France and a participant of an Investor CSD), the rejection rule would not be triggered on the realignment instructions, and the transaction could be eligible for settlement.

The lock-up period on loyalty bonus shares related to specific French ISINs is also applicable to Investor CSDs. Therefore, Investor CSDs need to implement the rule in order to prevent DVP settlement on these ISINs in intra-CSD and cross-CSD scenarios, to retain their benefits. In practice, this process only affects a dozen of ISIN codes, therefore the quantitative impact on Investor CSDs should be limited.

4.1.7 Euroclear Finland

Pre T2S – Process Controls

Euroclear Finland has put in place adequate controls in its legacy system for CA processing.

In Euroclear Finland, the processing of CA Mandatory Re-organization without options (with same ISIN) – for example amortization – is done in following way:

When there is an existing position level restriction (PoLR) on the position eligible for CA, Euroclear Finland closes the existing PoLR and creates a new PoLR for the post-amortized value with reference to the original PoLR.

The new PoLR is created in the same proportion of the restricted balances. This is the reason for restricting other SI/SRs during the CA processing.

Adapted State – Process Controls

Euroclear Finland has defined “RTBS”, a negative blocking (Case 2 Restriction Type) rule, for the management of CAs. The restriction rule will be used to temporarily block settlement on an ISIN affected by a CA event until the CA is fully applied on all the affected securities accounts. During this period, only CA settlement is allowed on the ISIN, recognised by the ISO transaction code “CORP” included in the settlement instruction, which refers to CA on stock. The usage of this transaction code is controlled by privilege and will not be available to CSD participants. After all relevant CA instructions have been settled, the restriction on the ISIN will be removed so that regular trade-related settlement can resume.

This restriction will be used in the context of partial redemption events.

Cross-CSD Impact Analysis

Impact on Investor CSD account configuration

The restriction rule “RTBS” does not rely on account configuration parameters and does not involve account segregation, therefore no impact is foreseen on Investor CSDs’ account configuration.

Impact on Investor CSD settlement flows

The restriction rule “RTBS” will impact any cross-CSD settlement transaction involving realignment movements at Euroclear Finland on the ISIN(s) subject to blocking. As a result, for such transactions, no settlement will take place on these ISINs while the restriction rule is active, and an Investor CSD’s Business Settlement Instruction will be matched but “Pending” for settlement with the “security blocked” reason code (see the Section 3.2.1 for additional details).

However, the rule “RTBS” will not prevent intra-CSD settlement of trade-related transactions at Investor CSDs. Depending on the CA event, the rule will need to be implemented by Investor CSDs in order to ensure the consistency of securities positions; for instance, in case of Partial Redemptions, while the CA is being applied on the omnibus account of Investor CSDs in the Issuer CSD, Investor CSDs must also ensure that underlying participants’ securities positions to be affected by the CA are not being used for trade-related transactions.

4.1.8 Iberclear

Pre T2S – Process Controls

On Iberclear legacy platform, there is no dedicated cycle for settlement for mandatory corporate actions. When required, CA settlement can also take place during the day.

Regarding the voluntary or mandatory corporate actions with options, settlement in Iberclear is performed at the end of the settlement day for value next business day.

For Reorganisations, blocking is performed at the level of the ISIN during the application of the CA. In addition, for elective CA, securities are earmarked in a specific position at the request of the participant.

Adapted State – Process Controls

Iberclear plans to define the following restriction rules in the context of CA processing:

- “ECO1/ECO2”: two Case 3 Restriction Type created to earmark securities in a dedicated securities position, at the request of the participant. This segregation is planned for elective corporate actions events. Those optional restrictions are created to facilitate CSD participants’ management of the elective CA process.
- EC11/EC12: two Case 3 Restriction Type created to earmark securities in a dedicated securities position. This segregation is planned for elective corporate actions events. Those mandatory restrictions are created for Iberclear’s management of the elective CA process.
- “IBR1”: a negative rejection rule (Case 1 Restriction Type). The rule will be used in this context to bypass the validation defined in the rule “RSP1” when settlement instructions are sent by Iberclear. “RSP1”: a positive rejection rule (Case 1 Restriction Type). The rule is defined to restrict the usage of the securities positions earmarked for mandatory and elective CA events so that all settlement instructions sent on these restricted positions (“EC11/EC12”) are rejected.
- “IBR2”: a negative rejection rule (Case 1 Restriction Type). The rule will be used in this context to bypass the validation defined in the rule “RSP2” when settlement restrictions are sent by Iberclear.
- “RSP2”: a positive rejection rule (Case 1 Restriction Type). The rule is defined to restrict the usage of the securities positions earmarked for mandatory and elective CA events so that all settlement restrictions sent on these restricted positions (“EC11/EC12”) are rejected.
- “BLEC”: a negative blocking rule (Case 2 Restriction Type) to temporarily block settlement on an ISIN affected by a CA event until the CA is fully applied on all the affected securities accounts. During this period, only CA settlement is allowed on the ISIN, recognised by the ISO transaction code “CORP” included in the settlement instruction, which refers to CA on stock. The usage of this transaction code is controlled by privilege and will not be available to CSD participants. After all relevant CA instructions have been settled, the restriction on the ISIN will be removed so that regular

trade-related settlement can resume. The selective blocking of securities might be activated when processing a partial redemption CA event.

The parameters configured in the rules are listed below:

IBR1/IBR2:

- Instructing Party Type, with the value:
 - CSD

RSP1/RSP2:

- Credited/Debited Position Balance with the values:
 - “ECI1/ECI2”: specific earmarked positions type to be used in the context of mandatory and elective CA events.

BLEC:

- Transaction Identification (ISO transaction code), with the value:
 - CORP

Cross-CSD Impact Analysis

Impact on Investor CSD account configuration

“ECO1/ECO2”:

To facilitate the management of elective CA, Iberclear participants can choose to temporarily earmark securities in specific positions (ECO1/ECO2) before the “Market Deadline” of the event. Alternatively, Investor CSDs can directly transmit a CA instruction so that Iberclear moves securities to the restricted positions ECI1/ECI2. It should be emphasised, that segregation in the “ECO1/ECO2” securities positions is only done upon request of the Investor CSD. It is therefore assumed that in this case the segregation would also be reflected by the Investor CSD on the account of its participants.

“IBR1 + RSP1 + ECI1/ECI2”:

The rule “IBR1” and “RSP1”, along with the position type “ECI1/ECI2”, are defined for mandatory and elective CA in order to earmark elected securities position into the “ECI1/ECI2” position type, and to restrict access to this position so that its usage is restricted to Iberclear (i.e. all settlement instructions sent by Investor CSDs on these restricted positions are rejected.). This segregation is applicable to the Investor CSD omnibus account. Investor CSDs must also apply segregation on the securities accounts of its participants, to earmark the elected positions, but can choose to segregate the positions into position types or into separate accounts. In the latter case, restriction to the earmarked securities could be achieved with the configuration of access rights instead of defining restriction rules.

“IBR2 + RSP2 + ECI1/ ECI2”:

The rule “IBR2” and “RSP2”, along with the position type “ECI1/ECI2”, are defined for mandatory and elective CA in order to earmark elected securities position into the “ECI1/ECI2” position type, and to restrict access to this position so that its usage is restricted to Iberclear (i.e. all settlement restrictions sent by Investor CSDs on these restricted positions are rejected.). This segregation is applicable to the Investor CSD omnibus account. Investor CSDs must also apply segregation on the securities accounts of its participants, to earmark the elected positions, but can choose to segregate the positions into position types or into separate accounts. In the latter case, restriction to the earmarked securities could be achieved with the configuration of access rights instead of defining restriction rules.

“BLEC”:

The restriction rule “BLEC” does not rely on account configuration parameters and does not mandate account segregation at the Issuer CSD, therefore no impact is foreseen on Investor CSDs’ account configuration.

Impact on Investor CSD settlement flows

The position types “ECO1” and “ECO2” would only apply to Investor CSDs’ omnibus accounts on their request. The restriction rule will not have a direct impact on trade-related cross-border instructions, as realignment instructions would not make use of the restricted positions; i.e. realignment instructions would not match the restriction rules. Investor CSDs opting for this segregation will most likely implement similar segregation in their books (by position types or separate accounts) in order to ensure consistency of available securities position (AWAS) between omnibus and participants’ accounts and prevent the risk of settlement fail at the level of the omnibus account provision check.

The rejection rules “IBR1 + RSP1” using the position type “ECI1/ECI2” will not be triggered for trade-related cross-CSD transactions since only the available position (“AWAS”) will be used by T2S generated Realignment Settlement Instructions. It is only in the case of a cross-CSD transaction where the Iberclear participant tries to deliver/receive from/in the earmarked position to/from a participant of another CSD that the rule would be triggered. It would also be the case if an Investor CSD would try to debit/credit directly the earmarked position in the omnibus account (this should not happen in normal business scenarios).

The rejection rules “IBR2 + RSP2” using the position type “ECI1/ECI2” will not be triggered for trade-related cross-CSD transactions since only the available position (“AWAS”) will be used by T2S generated Realignment Settlement Instructions and the object restriction type is settlement restriction. It would only be triggered if an Investor CSD would try to debit/credit directly the earmarked position in the

omnibus account through a settlement restriction, i.e. intra-position movement (this should not happen in normal business scenarios).

Those restrictions will be implemented in the context of mandatory and elective CA events, which will result in intra-CSD transactions: Investor CSDs must first earmark the elected positions of their participants in their books then communicate the elected positions to be earmarked in the Issuer CSD. Investor CSDs have the choice between following the segregation by position type implemented by Iberclear, and replicate the rule, or use their own segregation model to ensure that the elected securities positions are not used for trade-related settlement. This can be achieved with the configuration of access rights without defining restriction rules.

The restriction rule “BLEC” will impact any cross-CSD settlement transaction involving realignment movements at Iberclear on the ISIN(s) subject to blocking. As a result, for such transactions, no settlement will take place on these ISINs while the restriction rule is active, and an Investor CSD’s Business Settlement Instruction will be matched but “Pending” for settlement with the “security blocked” reason code (see the Section 3.2.1 for additional details).

However, the rule “BLEC” will not prevent intra-CSD settlement of trade-related transactions at Investor CSDs. Depending on the CA event, the rule will need to be implemented by Investor CSDs in order to ensure the integrity of securities positions; for instance, in case of Partial Redemptions, while the CA is being applied on the omnibus account of Investor CSDs in the Issuer CSD, Investor CSDs must also ensure that underlying participants’ securities positions to be affected by the CA are not being used for trade-related transactions. At present, the selective blocking of securities is planned to be activated for the processing of Partial Redemptions events.

4.1.9 Interbolsa

Pre T2S – Process Controls

CA settlement is performed at the end of the settlement day for value next business day after settlement of all other transactions. Blocking is performed at the level of the ISIN, during the application of Reorganisations (which change the underlying security’s characteristics). The only elective CA event being processed is rights subscription. The securities positions are not segregated as elected rights are converted into outturn temporary ISINs every evening during the election period.

Adapted State – Process Controls

Interbolsa plans to define several restriction rules in the context of CA processing:

- “RTBS”, a negative blocking (Case 2 Restriction Type) rule. The rule will be setup to temporarily block settlement on an ISIN affected by a CA event until the CA is fully applied on all the affected securities accounts. During this period, only CA settlement is allowed, recognised by the use of the following ISO transaction codes included in the settlement instruction: “CORP” (CA on stock), and

“CLAI” (Market Claims). The usage of these transaction codes is controlled by privilege and will not be available to CSD participants. After all relevant CA instructions have been settled, the restriction on the ISIN will be removed so that regular trade-related settlement can resume. According to the feedback collected, the rule will be setup for Reorganisations where the CA processing changes the underlying security.

- “SR01”, a negative rejection (Case 1 Restriction Type) rule. The rule will be used to bypass the validation defined in the rule “SR02” if settlement instructions include the following ISO transaction codes: “CORP” (CA on stock), and “CLAI” (Market Claims). The usage of these transaction codes is controlled by privilege and will not be available to CSD participants.
- “SR02”, a positive rejection (Case 1 Restriction Type) rule. The rule will be setup to reject settlement instructions on outturn and temporary ISINs created in the context of rights subscription. No MSA is needed for this rule. As Interbolsa will be compliant with the CAJWG model when migrating to T2S, with conversion of the rights only at the end of the subscription period, it is under analysis whether this rule will still be needed.
- “SR03”, a positive rejection (Case 1 Restriction Type) rule. The rule is generic and defined to reject settlement instructions sent by CSD participants debiting or crediting specific blocked/earmarked securities positions described below (“BL26”, “EA43”). No MSA is created for this rule. No specific business context applies to this rule, as it depends on the blocked/earmarked position type.
- “SR04”, a positive rejection (Case 1 Restriction Type) rule. The rule is generic and defined to reject settlement restrictions sent by CSD participants debiting or crediting specific blocked/earmarked securities positions described below. No MSA is created for this rule. No specific business context applies to this rule, as it depends on the blocked/earmarked position type.
- “BL26”, a Case 3 Restriction Type defined on securities positions. The restriction will be defined to block securities positions on which an election has been made in the context of Voluntary Reorganisations (i.e. rights subscriptions).
- “EA43”, a Case 3 Restriction Type defined on securities positions. The restriction will be defined in the context of rights subscription to earmark securities position on outturn ISINs (corresponding to the rights which have been exercised and segregated into the BL26 sub-position) until payment of proceeds into the outturn ISIN is performed. Sometimes temporary ISINs are used prior to outturn ISINs, and identified with an MSA on securities: “Intermediate/provisional securities”, with the value “Y” or “N” (for information purposes only).

Cross-CSD Impact Analysis

Impact on Investor CSD account configuration

The restriction rules “RTBS”, “SR01”, “SR02”, “SR03”, and “SR04” do not rely on account configuration parameters and do not involve account segregation, therefore no impact is foreseen on Investor CSDs’ account configuration.

The restriction “BL26” is setup for Voluntary Reorganisations (i.e. rights subscriptions), and blocks elected securities positions into a specific position type, which is applicable to Investor CSDs’ omnibus account. Investor CSDs must also apply the segregation on the securities accounts of their participants, to block the elected positions, but can choose to segregate the positions into position types or into separate accounts.

The restriction “EA43” is setup to earmark outturn securities positions in the context of rights subscription, at the end of the subscription period and until the payment is done. The rule will be applicable to Investor CSDs’ omnibus account. Investor CSDs must also apply the segregation on the securities accounts of their participants, to block the outturn temporary ISINs, but can choose to segregate the positions into position types or into separate accounts.

Impact on Investor CSD settlement flows

The restriction rule “RTBS” will impact any cross-CSD settlement transaction involving realignment movements at Interbolsa: no settlement other than the ones flagged for CA processing on stock will take place on the ISIN subject to blocking while the restriction rule is active, and the Investor CSD’s Business Settlement Instruction will be matched but “Pending” for settlement. Note that cross-CSD settlement instructions resulting from CA on flows, even if sent with the “CLAI” ISO transaction code (for processing of market claims), will be blocked, as realignment instructions always carry the “REAL” ISO transaction code.

However, the rule “RTBS” will not prevent intra-CSD settlement of trade-related transactions at Investor CSDs. Depending on the CA event, the rule will need to be implemented by Investor CSDs in order to ensure the consistency of securities positions; for instance, in case of Partial Redemptions, while the CA is being applied on the omnibus account of Investor CSDs in the Issuer CSD, Investor CSDs must also ensure that underlying participants’ securities positions to be affected by the CA are not being used for trade-related transactions. At present, the selective blocking of securities is planned to be activated for Reorganisations where the CA processing changes the underlying security (it is assumed that those Reorganisations do not involve a change in a new ISIN).

The restriction rule “SR02” will impact Investor CSDs’ settlement flows in the following way, unless the ISO transaction code “CORP” or “CLAI” is included in the settlement instructions (as defined in “SR01”):

- In case of a cross-CSD transaction between a participant of Interbolsa whose Business Instruction is matching the rule parameters and a participant of an Investor CSD, the Business Instruction sent by the participant of Interbolsa would be rejected, while the Business Instruction at the Investor CSD level would remain unmatched.
- In other cross-CSD scenarios generating realignments at Interbolsa (i.e. between Investor CSDs’ participants or a participant of Interbolsa and a participant of an Investor CSD), realignment instructions triggering the rule would not be generated and the Business Instructions would be cancelled after acceptance and matching.

Note that the negative rule allowing to bypass the control with ISO transaction code “CLAI” would not achieve this objective in the case of cross-CSD market claims: even if the Business Instruction on Interbolsa’s side is sent with the “CLAI” ISO transaction code, Business Instructions will be cancelled after being accepted and matched, as realignment instructions always carry the “REAL” ISO transaction code and will trigger the rule.

However, as the rules will be used in the context of rights subscriptions, to prevent settlement in the outturn ISIN until the subscription has been paid⁵⁴, none of the above cross-CSD scenarios should apply and the rules do not need be implemented by Investor CSDs. Nevertheless, Investor CSDs must have their own mechanism for segregation of elected positions, ensuring these positions are not used for trade-related settlement, and may opt for a segregation model by account or position type. In the former case, this can be achieved with access rights without defining restriction rules.

The rejection rule “SR03” using the position type “BL26” will not be triggered for trade-related cross-CSD transactions since only the available position (“AWAS”) will be used by T2S generated Realignment Settlement Instructions. It is only in the case of a cross-CSD transaction where the Interbolsa participant tries to deliver from the blocked position to a participant of another CSD that the rule would be triggered. It would also be the case if an Investor CSD would try to debit directly the blocked position in the omnibus account (this should not happen in normal business scenarios).

The restriction will be implemented in the context of Voluntary Reorganisations, which will result in intra-CSD transactions: Investor CSDs must first block the elected positions of their participants in their books then communicate the elected positions to be blocked in the Issuer CSD. Investor CSDs have the choice between following the segregation by position type implemented by Interbolsa, and replicate the rule, or use their own segregation model to ensure that the elected securities positions are not used for trade-related settlement. This can be achieved with the configuration of access rights without defining restriction rules.

The restriction “EA43” (used in conjunction with the rejection rule “SR03”) will not impact trade-related cross-CSD transactions since only the available position (“AWAS”) will be used by T2S generated Realignment Settlement Instructions. It is only in the case of a cross-CSD transaction where the Interbolsa participant tries to deliver from the earmarked position to a participant of another CSD that the rule would be triggered. It would also be the case if an Investor CSD would try to debit directly the earmarked position in the omnibus account (this should not happen in normal business scenarios).

The restriction will be implemented for outturn securities in the context of rights subscriptions after all elections have been made and until payment of securities proceeds. The restriction does not need to be replicated by Investor CSDs, however, Investor CSDs must have their own mechanism for segregation of elected positions, ensuring these positions are not used for trade-related settlement, and may opt for a

⁵⁴ The election process used by Interbolsa is slightly different than the CAJWG model and subject to change.

segregation model by account or position type. In the former case, this can be achieved with the configuration of access rights without defining restriction rules.

4.1.10 KDD

Pre T2S – Process Controls

There is no dedicated cycle for settlement of CA. When required, CA settlement can take place outside of normal processing schedule, e.g. on weekends, to minimise the impact on trade-related settlement. For Reorganisations, blocking is performed at the level of the ISIN during the application of the CA. In addition, for elective CA (take-over), securities positions are segregated into a separate account.

Adapted State – Process Controls

KDD plans to define “C201”, a negative blocking (Case 2 Restriction Type) rule. The rule will be setup to temporarily block settlement instructions on an ISIN affected by a CA event until the CA is fully applied on all the affected securities accounts. During this period, only CA settlement is allowed, recognised by the “CORP” ISO transaction code included in the settlement instruction. The usage of this transaction code is controlled by privilege and will not be available to CSD participants. After all relevant CA instructions have been settled, the restriction on the ISIN will be removed so that regular trade-related settlement can resume. No MSA is created in the context of this rule. The restriction rule will be used for Reorganisations as defined by KDD Rules and Regulations.

KDD will perform blocking of securities positions related to elective CA into separate accounts and no restriction rule will be setup for this purpose.

Cross-CSD Impact Analysis

Impact on Investor CSD account configuration

The restriction rule “C201” does not rely on account configuration parameters and does not involve account segregation, therefore no impact is foreseen on Investor CSDs’ account configuration.

Impact on Investor CSD settlement flows

The rule “C201” will impact any cross-CSD settlement transaction involving realignment movements at KDD. As a result, no settlement will take place on the ISIN subject to blocking while the restriction rule is active, and an Investor CSD’s Business Settlement Instruction will be matched but “Pending” for settlement (see the Section 3.2.1 for additional details).

However, the rule defined by the Issuer CSD will not prevent intra-CSD settlement of trade-related transactions at Investor CSDs. Depending on the CA event, the rule will need to be implemented by Investor CSDs in order to ensure the integrity of securities positions; for instance, in case of Partial Redemptions, while the CA is being applied on the omnibus account of Investor CSDs in the Issuer CSD, Investor CSDs must also ensure that underlying participants’ securities positions to be affected by the CA are not being used for trade-related transactions. At present, the selective blocking of securities is planned to be activated for the processing of Reorganisation events.

As explained in Section 4.1.2, an appropriate definition of the maturity/expiry date of an ISIN in T2S could be used as an effective way to prevent settlement between participants in the underlying security after Record Date, in the context of Reorganisations involving a change of ISIN, and therefore alleviate the need for a restriction rule in both Issuer and Investor CSDs.

4.1.11 KELER

Pre T2S – Process Controls

There is no dedicated cycle for settlement of CA, but CA related transactions are treated with a higher priority in the settlement engine compared to trade-related transactions. For Reorganisations that involve nominal or currency change, KELER suspends the affected ISIN(s) in its records until the related CA is processed. This control originates from an agreement between the issuer and KELER. Transaction restriction can be performed at the level of the ISIN due to regulation in case of general meetings of private limited companies. KELER currently does not process elective CA events. In addition, KELER maintains internal statuses in its legacy system for the lifecycle of securities. Such statuses are applied upon opening or closing of the securities and validation rules prevent acceptance of settlement instructions on these objects while in this opening or closing process.

Adapted State – Process Controls

KELER plans to implement restriction rules in order to process with the suspension of an ISIN mandated by the issuer, as well as mirror statuses it has on its legacy system at the opening and closing of an ISIN:

- “RT05_Security_Reject”, two positive rejection (Case 1 Restriction Type) rules. The rules will be defined to reject settlement instructions and settlement restrictions on specific ISINs for which status is “in capture”, “suspended”, “to be deleted”, “redeemed”, or “deleted”. The “Security Status” will be defined with an MSA. This restriction rule is mapped to Reorganisations in the context explained here above and will apply as from the suspension date (in the case of status “Suspended”), or will apply at the opening or closing of a security (for statuses “in capture”, “to be deleted”, “deleted”, or “redeemed”).
- “RT05_Security_Reject”, a negative rejection (Case 1 Restriction Type) rule. This rule will be defined as an exception to the previous rule to ensure that CA settlement is allowed, recognised by the “CORP” ISO transaction code, for those securities with statuses “to be deleted”, “deleted”, or “redeemed”
- “RT06_Security_Block”, a negative blocking (Case 2 Restriction Type) rule. The rule will be setup to block settlement of pending transactions on an ISIN affected by a Reorganisation in the context explained here above (where relevant, i.e. when there is no change of ISIN). During this period, only CA settlement is allowed, recognised by the “CORP” ISO transaction code included in the settlement instruction. The usage of this transaction code is controlled by privilege and will not be available to CSD participants. After all relevant CA instructions have been settled, the restriction on the ISIN will be removed so that regular trade-related settlement can resume.

As KELER does not process elective CA events, no adaptation is planned in the context of the T2S migration.

Cross-CSD Impact Analysis

Impact on Investor CSD account configuration

The rules “RT05_Security_Reject” does not rely on account parameters and does not involve account segregation, therefore no impact is foreseen on the Investor CSD account configuration.

The rule “RT06_Security_Block” does not rely on account parameters and does not involve account segregation, therefore no impact is foreseen on the Investor CSD account configuration.

Impact on Investor CSD settlement flows

The rule “RT05_Security_Reject” defined at the level of settlement instructions (object restriction type: settlement instruction) will impact any cross-CSD settlement transaction involving realignment movements at KELER on the ISIN(s) subject to suspension. In specific scenarios, the Investor CSD’s Business Settlement Instruction will be cancelled after being accepted and matched (see the Section 3.2.1 for additional details).

However, the rule itself will not prevent intra-CSD settlement of e.g. trade-related transactions at the Investor CSD, which could result in a change in the Investor CSD’s participants’ securities positions in the suspended ISIN before the CA has been applied and related settlement instructions settled. This rule should also be implemented by Investor CSDs, at least in this case, i.e. when MSA status is “suspended”.

At the opening or closing of a security, internal validation rules already exist in T2S so that an instruction entered by CSD participants is only validated successfully if within the validity period of the security. Therefore, the related statuses, “in capture”, “to be deleted”, “deleted”, or “redeemed”, do not need to be replicated by Investor CSDs. It has to be ensured by KELER that those are synchronised with the T2S validity dates and in compliance with Corporate Actions standards.

The rule “RT05_Security_Reject” defined at the level of settlement restrictions (object restriction type: settlement instruction) will not impact Investor CSDs’ settlement flows, except if an Investor CSD would instruct an intra-position movement directly on its omnibus account on the ISIN(s) subject to rejection. Investor CSDs may consider implementing the rule depending on their operating model (i.e. creation of position types) and internal rules and procedures.

The rule “RT06_Security_Block” will impact any cross-CSD settlement transaction involving realignment movements at KELER on the ISIN(s) subject to blocking. As a result, no settlement will take place on these ISINs while the restriction rule is active, and an Investor CSD’s Business Settlement Instruction will be matched but “Pending” for settlement.

However, the rule defined by the Issuer CSD will not prevent intra-CSD settlement of trade-related transactions at Investor CSDs. The rule will need to be implemented by Investor CSDs in order to ensure the consistency of securities positions and activated depending on the CA event; for instance, in case of

Partial Redemptions, while the CA is being applied on the omnibus account of Investor CSDs in the Issuer CSD, Investor CSDs must also ensure that underlying participants' securities positions to be affected by the CA are not being used for trade-related transactions.

4.1.12 LuxCSD

Feedback on the Restriction Rules Sanity Check is pending.

4.1.13 Malta Stock Exchange

Feedback on the Restriction Rules Sanity Check is pending.

4.1.14 Monte Titoli

Pre T2S – Process Controls

In Monte Titoli's legacy systems, a specific cycle is dedicated for settlement of CA on stock at the start of the settlement day. In addition, blocking is performed at the level of the ISIN (underlying and outturn), and sometimes securities account during the application of Reorganisations.

For dividend only, in case there is a dividend waiver, balances for the same ISIN are moved on a different suffix (considered as interim ISIN).

Adapted State – Process Controls

Monte Titoli plans to define several restriction rules in the context of CA processing:

- “RBCA”, a negative blocking (Case 2 Restriction Type) rule. The rule will be defined to temporarily block settlement on an ISIN affected by a CA event until the CA is fully applied on all the affected securities accounts. During this period, only CA settlement is allowed, recognised by the use of the following ISO transaction code included in the settlement instruction: “CORP”. The usage of this transaction code is controlled by privilege and will not be available to CSD participants. After all relevant CA instructions have been settled, the restriction on the ISIN will be removed so that regular trade-related settlement can resume. No MSA is created in the context of this rule. According to the feedback collected, the rule will be applied for the following CA events: Redemptions, Mandatory Conversions, Capital Increases with rights.
- “RC1F”, a positive rejection (Case 1 Restriction Type) rule. The rule will be defined to reject settlement instructions on segregated securities positions “CUS1” unless instructed by Monte Titoli (with the CSD as Instructing Party). The blocked securities positions are created with a Restriction Type 3. No MSA is needed for this rule. The business context of this rule is described in the “CUS1” restriction hereafter.
- “RC1R”, a positive rejection (Case 1 Restriction Type) rule. The rule will be defined to reject settlement restrictions on blocked securities positions “CUS1” unless instructed by Monte Titoli (with the CSD as Instructing Party). The blocked securities positions are created with a Case 3 Restriction

Type. No MSA is needed for this rule. The business context of this rule is described in the “CUS1” restriction hereafter.

- “CUS1”, a Case 3 Restriction Type defined on securities positions. The restriction will be defined to block securities position in the context of elective CA, and in particular the following events: Voluntary Conversion, Exercise of Warrants, and Capital Increase with Rights (on the originating positions).
- “RC2I”, a positive rejection (Case 1 Restriction Type) rule. The rule will be defined to reject settlement instructions on segregated securities positions “CUS2” unless instructed by Monte Titoli (with the CSD as Instructing Party). The blocked securities positions are created with a Restriction Type 3. No MSA is created for this rule. The business context of this rule is described in the “CUS2” restriction hereafter.
- “RC2R”, a positive rejection (Case 1 Restriction Type) rule. The rule will be defined to reject settlement restrictions on blocked securities positions “CUS2” unless instructed by Monte Titoli (with the CSD as Instructing Party). The blocked securities positions are created with a Case 3 Restriction Type. No MSA is needed for this rule. The business context of this rule is described in the “CUS2” restriction hereafter.
- “CUS2”, a Case 3 Restriction Type defined on securities positions. The restriction will be defined for segregation and blocking of securities position in order to manage deposit, split, and withdrawals operations on physical securities⁵⁵ immobilised in Monte Titoli and represented by a global certificate.

The following rules have been defined by Monte Titoli for CA management as Investor CSD of Clearstream Banking Frankfurt:

- “VHEC”, a positive CSD Validation Hold (Case 1 Restriction Type) rule. The rule will be defined to put on CSD Validation Hold settlement instructions debiting or crediting the earmarked position “EXCM” in order to verify that the transfer is allowed. Both instructions sent by CSD participants as well as Monte Titoli as Instructing Party will be placed on CSD Validation Hold. The business context of this rule is described in the “EXCM” restriction hereafter.
- “REXR”, a positive rejection (Case 1 Restriction Type) rule. The rule will be defined to reject settlement restrictions on earmarked securities positions “EXCM” unless instructed by Monte Titoli (with the CSD as Instructing Party). The business context of this rule is described in the “EXCM” restriction hereafter.
- “EXCM”, a Case 3 Restriction Type defined on securities positions. The restriction will be defined to earmark securities position of German securities corresponding to the quantity ex-dividend which are

⁵⁵ There is only a small percentage of physical securities held by Monte Titoli as Issuer CSD, as the vast majority of securities is held in dematerialised form. These physical securities are processed by book-entry and fungible from a settlement perspective.

considered cum-dividend in Germany. The background of this rule is that in Germany, for some events, Record Date is before Ex-Date, whereas in Monte Titoli, according to the CA standards, EX-Date is always before Record Date⁵⁶. Monte Titoli therefore needs to manage ex/cum securities positions during this short period.

Cross-CSD Impact Analysis

Impact on Investor CSD account configuration

The rule “RBCA” does not rely on account configuration parameters and does not involve account segregation, therefore no impact is foreseen on Investor CSDs’ account configuration.

The rule “RC1I” and “RC1R”, along with the position type “CUS1”, are defined for elective CA (Voluntary Conversion, Exercise of Warrants, and Capital Increase with Rights) in order to block elected securities position into the “CUS1” position type, and to restrict access to this position. This segregation is applicable to the Investor CSD omnibus account. Investor CSDs must also apply segregation on the securities accounts of its participants, to block the elected positions, but can choose to segregate the positions into position types or into separate accounts.

The specific position type “CUS2” will be created in Monte Titoli to block physical securities in case of deposit, withdrawal, or split operations on the global certificate. Investor CSDs holding these securities should ensure to have a mechanism preventing the settlement of these securities while these operations are performed.

The position type “EXCM”, along with the rules defined to restrict access to this position, “VHEC” and “REXR”, are necessary because of the difference in key CA dates between Germany and other markets for some CA event types. According to Monte Titoli, the volume of CA to be handled in this way averages less than one event per day. Investor CSDs of Monte Titoli do not hold German securities via relayed link (through Monte Titoli), and are therefore not impacted by the rule.

As stated earlier, it is important to note that from January 2017, the German market will align this market practice to the recommended CA standards and such restriction rule will not be needed.

Until that date, other Investor CSDs of Clearstream Banking Frankfurt (via direct CSD link) may need to put specific controls in place to handle the differences in CA processing dates.

Impact on Investor CSD settlement flows

The rule “RBCA” will impact any cross-CSD settlement transaction involving realignment movements at Monte Titoli. As a result, no settlement will take place on the ISIN subject to blocking while the restriction rule is active, and an Investor CSD’s Business Settlement Instruction will be matched but “Pending” for settlement (see the Section 3.2.1 for additional details).

⁵⁶ From January 2017, the German market will align this market practice to the recommended CA standards and such restriction rule will not be needed

However, the rule defined by the Issuer CSD will not prevent intra-CSD settlement of trade-related transactions at Investor CSDs. Depending on the CA event, the rule will need to be implemented by Investor CSDs in order to ensure the consistency of securities positions; for instance, in case of Partial Redemptions, while the CA is being applied on the omnibus account of Investor CSDs in the Issuer CSD, Investor CSDs must also ensure that underlying participants' securities positions to be debited or affected by the CA are not being used for trade-related transactions. Monte Titoli will activate the rule for the following CA events: Redemptions, Mandatory Conversions, Capital Increases with rights. As explained in Section 4.1.2, an appropriate definition of the maturity/expiry date of an ISIN in T2S could be used as an effective way to prevent settlement between participants in the underlying security after Record Date, in the context of Reorganisations involving a change of ISIN, and therefore alleviate the need for a restriction rule in both Issuer and Investor CSDs.

The rule "RC1I" and "RC1R", along with the position type "CUS1" are defined for elective CA on stock, and are therefore only subject to intra-CSD transactions. These rules will not impact trade-related cross-CSD transactions since only the securities in the available position ("AWAS" Position Type) will be used by T2S generated Realignment Settlement Instructions. It is only in the case of a cross-CSD transaction where the Monte Titoli participant tries to deliver from the blocked position to a participant of another CSD that the rule would be triggered. It would also be the case if an Investor CSD would try to debit directly the blocked position in the omnibus account (this should not happen in normal business scenarios). Investor CSDs should ensure to prevent settlement of elected securities positions in their books for trade-related transactions by restricting access to the segregated securities positions.

The rules "RC2I" and "RC2R" along with the position type "CUS2" are defined for CA on stock, and are therefore only subject to intra-CSD transactions. These rules will not impact trade-related cross-CSD transactions since only the securities in the available position ("AWAS" Position Type) will be used by T2S generated Realignment Settlement Instructions. It is only in the case of a cross-CSD transaction where the Monte Titoli participant tries to deliver from the blocked position to a participant of another CSD that the rule would be triggered. It would also be the case if an Investor CSD would try to debit directly the blocked position the omnibus account (this should not happen in normal business scenarios). Investor CSDs should ensure to prevent settlement of the securities subject to CA in their books depending on the operation performed by the Issuer.

The rules "VHEC" and "REXR", along with the position type "EXCM" are defined to manage ex/cum securities positions on German securities due to non-compliance of Germany to CA standards regarding ex-date and record date for some CA events.

From a technical perspective, the rule can affect cross-CSD transactions involving a Monte Titoli participant where there is a delivery from or into the "EXCM" position type. T2S generated Realignment Instructions will not be impacted as these always use the available (AWAS) position.

As stated above, the question remains whether controls will need to be put in place by Investor CSDs of Clearstream Banking Frankfurt in the context of this rule, and how this will impact cross-CSD flows.

4.1.15 NBB-SSS

In the NBB-SSS, for CA Reorganisations events, the agent of the Issuer gets the securities back on a SAC he provides in advance to the market. This happens during the period where the investor can participate.

On "payment date", the agent asks the NBB-SSS to redeem those securities. He delivers FREE the securities to the NBB-SSS and we match using the issuance account.

On that date, the participating amount of securities are not available for trades since they have been centralised by the agent. So no restriction needed.

4.1.16 OeKB CSD

Pre T2S – Process Controls

There is no dedicated cycle for settlement of CA, and CA related transactions aren't treated with a higher priority in the settlement engine compared to trade-related transactions. However, for Reorganisations which do not involve a change of ISIN and result in a change of holdings (e.g. Partial Redemptions), blocking is performed at the level of the ISIN during the application of the CA. In addition, securities positions are segregated into separate accounts, belonging to each OeKB CSD participant, in the context of rights subscription (rights are represented by an interim ISIN for the duration of the election).

Adapted State – Process Controls

OeKB CSD plans to define the following restriction rules in T2S:

- “R-1”, a positive/negative rejection (Case 1 Restriction Type) rule on account level. The rule will be defined to reject settlement instructions on accounts that are “Technically blocked” (identified with MSA), unless instructed by OeKB CSD. These accounts, belonging to OeKB CSD participants, will be used to hold elected securities position in the interim ISIN in the context of rights subscriptions⁵⁷. An MSA “Account Type” will be created for this purpose.
- “R-7”, a negative blocking (Case 2 Restriction Type) rule. The rule will be setup to temporarily block settlement on an ISIN affected by a CA event until the CA is fully applied on all the affected securities accounts. During this period, only CA settlement is allowed, recognised by the “CORP” ISO transaction code included in the settlement instruction. The usage of this transaction code is controlled by privilege and will not be available to CSD participants. After all relevant CA instructions have been settled, the restriction on the ISIN will be removed so that regular trade-related settlement can resume. According to the feedback collected, the rule will be applied for CA events that do not involve a change of ISIN and result in a change of holdings, e.g. Partial Redemptions.

Cross-CSD Impact Analysis

Impact on Investor CSD account configuration

⁵⁷ Another possibility under discussion between OeKB CSD and its participants is to block the respective holdings in the rights directly on the main account of each participant.

The rule “R-1” is setup in the context of rights subscriptions, and involves segregation of securities positions in a specific account belonging to each OeKB CSD participant, including Investor CSDs. Investor CSDs must also apply the segregation on the securities accounts of their participants, to block the elected positions of their participants in their books and then communicate the elected positions to be blocked in the Issuer CSD, but can choose to segregate the positions into position types or into separate accounts.

The rule “R-7” does not rely on account configuration parameters and does not involve account segregation, therefore no impact is foreseen on Investor CSDs’ account configuration.

Impact on Investor CSD settlement flows

The rule “R-1” will be used purely in the context of intra-CSD transactions for accounts held with OeKB CSD, to block rights represented by an Interim ISIN in the context of a rights subscription event. Therefore, the rule will not impact cross-CSD transactions involving Investor CSDs. However, as for segregation of elected positions, Investor CSDs have the choice between following the segregation model implemented by OeKB CSD and replicate the rule, or using their own segregation model (by account or position type) and ensure that the elected securities positions are not used for trade-related settlement. This can be achieved with access rights without defining restriction rules.

The rule “R-7” will impact any cross-CSD settlement transaction involving realignment movements at OeKB CSD. As a result, no settlement will take place on the ISIN subject to blocking while the restriction rule is active, and an Investor CSD’s Business Settlement Instruction will be matched but “Pending” for settlement (see the Section 3.2.1 for additional details).

However, the rule defined by the Issuer CSD will not prevent intra-CSD settlement of trade-related transactions at Investor CSDs. Depending on the CA event, the rule will need to be implemented by Investor CSDs in order to ensure the integrity of securities positions; for instance, in case of Partial Redemptions, while the CA is being applied on the omnibus account of Investor CSDs in the Issuer CSD, Investor CSDs must also ensure that underlying participants’ securities positions to be affected by the CA are not being used for trade-related transactions. At present, the selective blocking of securities is planned to be activated for the processing of CA events that do not involve a change of ISIN and result in a change of holdings (which includes Partial Redemptions).

4.1.17 SIX-SIS

Pre T2S – Process Controls

In SIX-SIS legacy systems, a specific processing cycle is dedicated for settlement of CA on stock at the start of the settlement day. No blocking is performed at the level of the ISIN in case of Reorganisations. For elective CA as well as Mandatory Reorganisations, securities positions are segregated within a sub-position into the same account.

Adapted State – Process Controls

SIX-SIS plans to define the following restriction rules in the context of CA processing:

- “RT03”, a positive rejection (Case 1 Restriction Type) rule. The rule will be setup to reject settlement restrictions sent by DCP participants of SIX-SIS on specific securities positions. The parameters used in the context of the rule are the following:
 - Instructing Party with the value of the DCP’s BIC
 - Debited or Credited Position, with the following values: “BL08”, “BL10”, “BL12”
- “RT04”, a positive rejection (Case 1 Restriction Type) rule. The rule will be setup to reject settlement instructions sent by DCP participants of SIX-SIS on specific securities positions. The parameters used for the configuration of the rule are the following:
 - Instructing Party with the value of the DCP’s BIC
 - Debited or Credited Position, with the following values: “BL08”, “BL10”, “BL12”

The following position types will be used in the configuration of the restriction rules described here above, to restrict access to these positions:

- “BL08”, a Case 3 Restriction Type defined on securities positions. The restriction will be defined to block securities positions on which an election has been made in the context of CA events with Proxy voting.
- “BL10”, a Case 3 Restriction Type defined on securities positions. The restriction will be defined to block securities positions in the outturn ISIN in the context of Mandatory Reorganisations. On Payment Date, securities positions in the outturn ISIN will temporarily be blocked in the dedicated position type, then transferred into the available position once confirmation is provided from the relevant party (Issuer, Issuer CSD, or Custodian) that the CA has been successfully carried out.
- “BL12”, a Case 3 Restriction Type defined on securities positions. The restriction will be defined to block securities positions on which an election has been made in the context of Voluntary Reorganisations.

Cross-CSD Impact Analysis

Impact on Investor CSD account configuration

The restriction “BL08” is defined in the context of CA events with Proxy Voting and blocks securities into a specific position type, which is applicable to Investor CSDs’ omnibus account. Investor CSDs must also apply the segregation on the securities accounts of their participants, to block the elected positions, but can choose to segregate the positions into position types or into separate accounts.

The restriction “BL10” is defined in the context of Mandatory Reorganisations and blocks securities in the outturn ISIN into a specific position type, which is applicable to Investor CSDs’ omnibus accounts. Investor CSDs do not need to segregate the positions in their books, but must ensure that settlement in the outturn ISIN does not take place through a blocking on ISIN level (Case 2 Restriction Type), until

securities are transferred into the available position in the omnibus account. Alternatively, Investor CSDs can also choose to replicate the process put in place by SIX-SIS, and segregate such securities positions in their books into position types or into separate accounts.

The restriction “BL12” is defined in the context of Voluntary Reorganisations and blocks securities into a specific position type, which is applicable to Investor CSDs’ omnibus account. Investor CSDs must also apply the segregation on the securities accounts of their participants, to block the elected positions, but can choose to segregate the positions into position types or into separate accounts.

Impact on Investor CSD settlement flows

The rejection rules “RT03” and “RT04” using the position type “BL08” and “BL12” will not be triggered for trade-related cross-CSD transactions since only the available position (“AWAS”) will be used by T2S generated Realignment Settlement Instructions. It is only in the case of a cross-CSD transaction where the SIX-SIS participant tries to deliver from the blocked position to a participant of another CSD that the rule would be triggered. It would also be the case if an Investor CSD would try to debit directly the blocked position in the omnibus account (this should not happen in normal business scenarios).

The restriction rules will be implemented in the context of CA events with Proxy Voting (“BL08”) and Voluntary Reorganisations (“BL12”), which will result in intra-CSD transactions: Investor CSDs must first block the elected positions of their participants in their books then communicate the elected positions to be blocked in the Issuer CSD. Investor CSDs have the choice between following the segregation by position type implemented by SIX-SIS, and replicate the rule, or use their own segregation model to ensure that the elected securities positions are not used for trade-related settlement. This can be achieved with the configuration of access rights without defining restriction rules.

The rejection rules “RT03” and “RT04” using the position type “BL10” will not be triggered for trade-related cross-CSD transactions since only the available position (“AWAS”) will be used by T2S generated Realignment Settlement Instructions. It is only in the case of a cross-CSD transaction where the SIX-SIS participant tries to deliver from the blocked position to a participant of another CSD that the rule would be triggered. It would also be the case if an Investor CSD would try to debit directly the blocked position in the omnibus account (this should not happen in normal business scenarios).

The restriction rules will be implemented in the context of Mandatory Reorganisations (“BL10”), to temporarily block securities positions in the outturn ISIN until confirmation is provided by the relevant party that the CA has been processed successfully. Investor CSDs must ensure that settlement in the outturn ISIN does not take place until the CA is successfully processed, and can do so through a blocking on ISIN level (Case 2 Restriction Type). Alternatively, Investor CSDs can also choose to replicate the process put in place by SIX-SIS, and segregate such securities positions in their books into position types or into separate accounts.

4.1.18 VPLux

Pre T2S – Process Controls

A specific cycle is dedicated for settlement of CA on stock at the start of the settlement day. In addition, blocking is performed at the level of the ISIN for CA that do not involve a change of ISIN and result in a change of holdings, e.g. Partial Redemptions. VPLux currently does not process elective CA events.

Adapted State – Process Controls

VPLux plans to define “ISBL”, a negative blocking (Restriction Type 2) rule. The rule will be setup to temporarily block settlement on an ISIN affected by a CA event until the CA is fully applied on all the affected securities accounts. During this period, only CA settlement is allowed, recognised by the “CORP” ISO transaction code included in the settlement instruction. The usage of this transaction code is controlled by privilege and will not be available to CSD participants. After all relevant CA instructions have been settled, the restriction on the ISIN will be removed so that regular trade-related settlement can resume.

According to the feedback collected, the rule will be applied for CA events that do not involve a change of ISIN and result in a change of holdings, e.g. Partial Redemptions. VPLux does not handle elective CA and does not plan to implement any specific process in this context.

Cross-CSD Impact Analysis

Impact on Investor CSD account configuration

The rule “ISBL” does not rely on account configuration parameters and does not involve account segregation, therefore no impact is foreseen on Investor CSDs’ account configuration.

Impact on Investor CSD settlement flows

The rule “ISBL” will impact any cross-CSD settlement transaction involving realignment movements at VPLux. As a result, no settlement will take place on the ISIN subject to blocking while the restriction rule is active, and the Investor CSD’s Business Settlement Instruction will be matched but “Pending” for settlement.

However, the rule defined by the Issuer CSD will not prevent intra-CSD settlement of trade-related transactions at Investor CSDs. Depending on the CA event, the rule will need to be implemented by Investor CSDs in order to ensure the consistency of securities positions; for instance, in case of Partial Redemptions, while the CA is being applied on the omnibus account of Investor CSDs in the Issuer CSD, Investor CSDs must also ensure that underlying participants’ securities positions to be affected by the CA are not being used for trade-related transactions. At present, the selective blocking of securities is planned to be activated for the processing of CA events that do not involve a change of ISIN and result in a change of holdings (which includes Partial Redemptions).

4.1.19 VP Securities

Pre T2S – Process Controls

A specific cycle is dedicated for settlement of CA on stock at the start of the settlement day. In addition, blocking is performed at the level of the ISIN for CA that do not involve a change of ISIN and result in a

change of holdings, e.g. Partial Redemptions. VP handles all elective CA with the generation of temporary ISINs representing the options, and this process does not require further segregation of elected securities positions.

Adapted State – Process Controls

VP plans to define “ISBL”, a negative blocking (Case 2 Restriction Type) rule. The rule will be setup to temporarily block settlement on an ISIN affected by a CA event until the CA is fully applied on all the affected securities accounts. During this period, only CA settlement is allowed, recognised by the “CORP” ISO transaction code included in the settlement instruction. The usage of this transaction code is controlled by privilege and will not be available to CSD participants. After all relevant CA instructions have been settled, the restriction on the ISIN will be removed so that regular trade-related settlement can resume.

According to the feedback collected, the rule will be applied for CA events which do not involve a change of ISIN and result in a change of holdings, e.g. Partial Redemptions.

VP does not plan to setup restriction rules to handle elective CA, as the process relies on the usage of temporary ISINs and does not require segregation of securities positions.

Cross-CSD Impact Analysis

Impact on Investor CSD account configuration

The rule “ISBL” does not rely on account configuration parameters and does not involve account segregation, therefore no impact is foreseen on the Investor CSD account configuration.

Impact on Investor CSD settlement flows

The rule “ISBL” will impact any cross-CSD settlement transaction involving realignment movements at VP. As a result, no settlement will take place on the ISIN subject to blocking while the restriction rule is active, and an Investor CSD’s Business Settlement Instruction will be matched but “Pending” for settlement.

However, the rule defined by the Issuer CSD will not prevent intra-CSD settlement of trade-related transactions at Investor CSDs. Depending on the CA event, the rule will need to be implemented by Investor CSDs in order to ensure the consistency of securities positions; for instance, in case of Partial Redemptions, while the CA is being applied on the omnibus account of Investor CSDs in the Issuer CSD, Investor CSDs must also ensure that underlying participants’ securities positions to be affected by the CA are not being used for trade-related transactions. At present, the selective blocking of securities is planned to be activated for the processing of CA events that do not involve a change of ISIN and result in a change of holdings (which includes Partial Redemptions).

Conclusion

CA processing is a necessary process performed by each Issuer and Investor CSD as part of standard customer asset servicing, and this translates in a large number of restriction rules to be

implemented on the T2S platform: among the CSDs in scope of this analysis, 19 have defined restriction rules for the management of CA and related settlement instructions, while 4⁵⁸ do not need restriction rules to process CA.

Depending on the CSD, restriction rules are created to control the processing and settlement of different CA events, according to their operational model and market practices, as illustrated in the table below:

Table 11 - Overview of usage of restriction rules for management of CA

CSD	Type of restriction ⁵⁹	CA events for which the rule applies	Number of MSAs
Baltic CSDs	Securities positions blocking (Case 3)	Elective CA	0
CDCP	ISIN blocking (Case2)	Partial and full Redemptions	0
Clearstream	ISIN blocking (Case2)	Following Reorganisations: Redemptions, Redemptions in securities, Reclassification, Conversion of Shares, Capital Decrease, Merger, Pari-Passu, Reverse Stock Split, Series-/Group Split, Intermediates to Lead Manager.	0
Depozitarul	ISIN blocking (Case2)	Under analysis	0
Central	Rejection (Case 1)	No specific CA events (access rights validation for the usage of “CORP” ISO transaction code)	0
ESES (Euroclear Belgium, Euroclear France, Euroclear Netherlands)	Rejection (Case 1)	Compatibility between accounts and securities, no specific CA events	4

⁵⁸ BOGS, LuxCSD, Malta Stock Exchange and NBB-SSS.

⁵⁹ Please note that Case 3 restriction types (allowing segregation of securities account through sub-positions) described below are used along with Case 1 or Case 2 restriction types to restrict access to these sub-positions.

CSD	Type of restriction⁵⁹	CA events for which the rule applies	Number of MSAs
Euroclear Finland	ISIN blocking (Case2)	Partial redemption	0
Iberclear	Securities positions blocking (Case 3)	Elective CA	0
Interbolsa	ISIN blocking (Case2)	Reorganisations where the CA processing changes the underlying security	0
	ISIN rejection (Case1)	Rights subscriptions	1⁶⁰
	Securities positions blocking (Case 3)	Elective CA	0
KDD	ISIN blocking (Case2)	Reorganisations as defined by KDD Rules and Regulations	0
KELER	ISIN rejection (Case1)	Specific Reorganisation events, and opening and closing of a security	1
	ISIN blocking (Case 2)	Specific Reorganisation events	0
Monte Titoli	ISIN blocking (Case2)	Redemptions, Mandatory Conversions, Capital Increases with rights	0
	Securities positions blocking (Case 3)	Elective CA: Voluntary Conversion, Exercise of Warrants, and Capital Increase with Rights (on the originating positions)	0
OeKB CSD	Rejection (Case 1)	Rights subscriptions	1
	ISIN blocking (Case2)	CA events which do not involve a change of ISIN and result in a change of holdings	0
SIX-SIS	Securities positions blocking (Case 3)	Elective CA and Mandatory Reorganisations	0
VPLux	ISIN blocking (Case2)	CA events which do not involve a change of ISIN and result in a change of holdings	0

⁶⁰ MSA is not used in the configuration of the rule, but for information purpose on “Intermediate/provisional securities”.

CSD	Type of restriction ⁵⁹	CA events for which the rule applies	Number of MSAs
VP	ISIN blocking (Case2)	CA events which do not involve a change of ISIN and result in a change of holdings	0

In the case of Reorganisations, a selective blocking of settlement instructions based on the ISIN will be commonly implemented by many CSDs in their role as Issuer and Investor CSD. The blocking is activated during the period of time in which the CSD(s) are applying the CA, to prevent changes in their participants' holdings until the CA is applied and all CA-related settlement instructions have been settled.

The CA events requiring the activation of this rule are not always defined and seem to differ between CSDs. Note that this does not necessarily imply a problem, as it could be the result of the complexity of CA which require a granularity beyond categories or event types to determine which processing to apply. Market and T2S CA standards are also supporting standardisation of CA processing and market practices and the respect to these standards are being monitored. However, if different rules were to be applied for the selective blocking of an ISIN, CSD participants would experience a different behaviour of T2S regarding the management of their settlement instructions, depending on the CSD managing the CA. Ultimately, such differences in CA handling could result in de-synchronisation of positions between Issuer and Investor CSDs because, e.g., trade-related transactions are settling in the Investor CSD while the CA is applied by the Issuer CSD: the blocking implemented by the Issuer CSD will not prevent intra-CSD settlement of trade-related transactions at Investor CSDs.

In the context of elective CA, segregation of securities positions is required, as “underlying securities on which an election is made should be separated accounting-wise from non-elected securities”⁶¹. The segregation needs to be performed both at Issuer CSD and Investor CSD level, according to the “Bottom-up” approach⁶², and can be achieved using either specific accounts or sub-positions within the same account. In the former case, access to the account can be restricted via privileges and does not necessarily require the setup of restriction rules in T2S. For the purpose of managing elective CA, different segregation models co-exist between the Issuer CSD and its Investor CSDs, but will result in different setup in terms of restriction rules, and reconciliation mechanisms of securities positions, as omnibus and mirror positions will differ.

⁶¹ CAJWG standards for Distribution with Options, Mandatory Reorganisations with Options, Voluntary Reorganisations

⁶² Election information is passed from end-investors, to Investor CSDs and intermediaries, up to the Issuer (CSD)

4.2 Registration

Introduction

For the assessment of restriction rules according to the methodology defined in Section 2.2 “Methodology to quantify impacts on Investor CSDs”, Registration is categorised as a necessary service from an Investor CSD’s standpoint. Indeed, registration services must be provided by the Issuer CSD for those registered securities that Investor CSDs hold in the books of the Issuer CSD.

Registration can be defined as the “function of keeping the central register for the issuer (of registered securities), which usually provides information on beneficial owners and/or end-investors”⁶³. The central register function can be performed by other entities that are not CSDs (i.e. register-maintaining entities), such as registrars, issuer agents, stock exchanges or the issuer itself. Most European markets have implemented registration processes and 73% of ECSDA CSDs currently offer registration services. 66% of the CSDs operating the central register in their country ensure this function under a legal privilege.

The provision of information on beneficial owners and/or end-investors to the issuers is the current key aim of registration. Registration provides transparency about shareholders as it allows issuers to identify beneficial owners and investors, thus enabling them to provide Investor Relation services.

In markets with registration practices it is usually the issuer who decides upon the issuance of the securities (in the prospectus) whether or not the security shall require or allow registration. Furthermore, registration can also be a requirement defined by the issuer for attaining certain rights (e.g. voting rights, loyalty bonus) on a registered share. Finally registration can serve as a means for issuers of monitoring or even (in some markets) controlling ownership.

In some markets, dedicated types of securities have been created, for which ownership needs to be granted by the issuer (“registered securities with restricted transferability“) such that shareholder groups can be excluded from obtaining ownership. This concept originates in family businesses, which aimed at controlling the transfer of securities to shareholders outside the family, but is also used in regulated industries.

In many markets the national legislation offers the issuers the choice between different types of securities (or share attributes) i.e. issuers have the choice between issuing “registered securities” (requiring registration) or “bearer securities” (not requiring registration). Over time more sub-types have been established in some markets such as bearer securities that can be converted into registered securities to account for additional issuer needs. In addition, in some markets there are securities for which registration is optional, depending on the choice of the investor. In this case of “on-demand registration”, the investor decides whether or not registration is to take place (otherwise these securities are handled as bearer

⁶³ Source: Public consultation on CSDs and on the harmonisation of certain aspects of securities settlement in the EU, 13 January 2011. Registration in terms of the CSD notary function is not within scope of the issue.

securities). Consequently, the securities which need to be registered “on-demand” can only be determined transaction-by-transaction and not exclusively based on their type.

According to the latest Harmonisation Report prepared by the HSG, although local registration procedures may have an impact on cross-CSD settlement efficiency resulting in inefficient and costly settlement processes, the issue is not perceived as a risk for the launch of T2S.

Registration procedures implemented in European markets vary depending upon various factors such as legal and regulatory needs, issuer’s requirements and market structure configuration⁶⁴ (i.e. direct holding versus indirect holding markets). The above mentioned factors govern the content, frequency and timing of information flow amongst the stakeholders.

The business requirements, controls and dependencies of the registration process are quite different from those of the securities settlement process; however, some markets tend to define registration procedures that are dependent upon the securities settlement process.

Each market may define registration processes to be performed before, after, or in parallel to the settlement process. Registration of securities may be required either in conjunction with a settlement activity, or corporate actions activity, events that entail a change in ownership (e.g. inheritance of registered securities) or events wherein the securities form changes from bearer to registered form.

In the context of the T2S, markets will continue to use the existing legacy processes for (re-)registration, and de-registration of securities, but settlement resulting from this activity will be performed on T2S. The CSDs have defined restriction rules in T2S with the objective of restricting the activities that could be executed by a T2S actor.

The description of the current controls and how these will be translated into restriction rules in T2S as well as the impact analysis is detailed per market in the next sections.

4.2.1 Clearstream Banking Frankfurt (CBF)

Pre T2S – Process Controls

In CBF, settlement of registered securities can be performed prior to their re-registration, as long as the securities have first been moved to an “Unregistered Position”. The "Unregistered Position" in CBF only reflects the fact that the actual holder of a security might deviate from the registered owner, whereas for the "Registered Position", the two are identical. The process of re-registration follows the settlement.

To enable this model, CBF has implemented necessary controls in their systems to ensure that registered securities are held in dedicated position types only. In specific cases, additional validations are performed to control settlement activity debiting or crediting registered securities from such dedicated position

⁶⁴ In direct holding markets, the end-investor / beneficial owner is the account holder in the CSD contrary to indirect holding markets wherein intermediaries are the account holders at the CSD. In some direct holding markets, concept of nominee accounts also exists, whereby the information regarding beneficiary owners is maintained by the intermediary offering nominee services.

types. The CSD or the issuer’s registrar performs the additional validations based on information provided by the registered owners or other intermediaries.

Investor CSDs, as any other CBF customer, are subject to the registration duty for registered shares, as outlined in the relevant German legislation (German AktG, §67), and therefore they may also have “Registered Positions” on their omnibus accounts held in CBF. Those “Registered Positions” are earmarked with a specific position type (whereas positions which are not registered – so-called “Freier Meldebestand” - are “held free”). It is important to note that (re-)registration of a security only needs to be performed within a reasonable amount of time, i.e. securities that have been unregistered can be resold without having been (re)-registered. For securities originating from either corporate actions or issuance, no controls or special validations are required to ensure completion of registration process prior to the settlement of corporate action or issuance related transactions. CBF has implemented additional validations to prevent the usage of securities positions resulting from CA for the purpose of OTC or stock exchange settlement prior to registration.

Adapted State – Process Controls

CBF has defined a specific earmarked position type (RSHB) to segregate registered securities from unregistered securities. Settlement instructions unregistering the securities (debiting the registered position type RSHB) will be put on “CSD Validation Hold” (in order for CBF to reflect the changes in its internal systems). Registering the securities (crediting the RSHB position type) could only be instructed via Clearstream (in ICP mode).

The diagram below shows the current Position Types used by CBF in the context of Registration and the mapping to future T2S Position Types:

Figure 13 – Clearstream’s future position keeping of registered shares

CASCADE RS Position Type	T2S Position Type ¹⁾	T2S Status
Unregistered Position (Freier Meldebestand – FMB)	AWAS	„Held Free“ (available for settlement)
Allocated Position (Zugewiesener Meldebestand – ZMB)	RSHB	„Earmarked“ (not available for settlement)
Registered Position (Hauptbestand – HB)		
Unregistered Position CA (freier Meldebestand aus Kapitalmaßnahmen – FMB KE)	RSKE	
Allocated Position CA (Zugewiesener Meldebestand aus Kapitalmaßnahmen – ZMB KE)		

CBF has defined the following restriction rules for the purpose of controlling the registration process:

Case 1 Restriction Type: Positive/Negative Rejection

- “Registered Shares – Reject”:
 - Settlement related to (re-)registration of registered securities: T2S must reject all settlement instructions crediting the “RSHB” position: the rationale is that this process can only be instructed in ICP mode as it relies on the usage of MT500 message. Therefore, it can only be instructed by CBF in T2S
 - Settlement related to de-registration of registered securities: T2S must reject all settlement instructions debiting the “RSHB” position except free of payment instructions on registered securities (identified with MSA on security level) on the registered position type (identified with MSA on account level) sent to T2S as already matched using a specific transaction code OWNE/OWNI (internal account transfers). The rationale is that DCPs can trigger deliveries out of their registered securities positions, subject to certain conditions (to be validated by CBF).

Case 1 Restriction Type: Positive CSD Validation Hold

- “Registered Shares – CVAL”:
 - Settlement related to de-registration of registered securities: T2S must put on CSD Validation Hold all instructions debiting “RSHB”. The rationale is that CBF must validate debit of registered positions triggered by DCPs (exception to the rejection rule described here above⁶⁵)

Clearstream has also defined a specific earmarked position type (RSKE) to be used in the issuance processes for registered shares. The restriction rules restrict the usage of this earmarked position type. Only Clearstream can instruct the transfer bookings on this earmarked position type.

The following restriction rules have been put in place:

Case 1 Restriction Type: Positive/Negative Rejection

- “Registered Shares – Reject”: T2S must reject all settlement instructions debiting or crediting the “RSKE” position except FOP instructions sent by CBF

Case 1 Restriction Type: Positive CSD Validation Hold

- “Registered Shares – CVAL”: T2S must put on CSD Validation Hold all instructions debiting or crediting “RSKE” (which have not been rejected, i.e. FOP instructions sent by CBF⁶⁶).
- Case 1 Restriction Type: Positive CSD Validation Hold (Registered Shares - CVAL). T2S puts on CSD Validation Hold settlement instructions fulfilling the following conditions:

The parameters configured in the rules are listed below:

- Registered Shares (MSA on securities) with the value: ‘YES’

⁶⁵ Case 1 rejection rules are checked before CSD Validation Hold rules.

⁶⁶ Case 1 rejection rules are checked before CSD Validation Hold rules.

- Position Type (MSA on account level) with the value: ‘RS’
 - Credited/Debited Position Balance with the values:
 - ‘RSHB’: registered position type
 - ‘RSKE’: a specific earmarked position type to be used in the issuance processes for registered shares
 - Instructing Party, with the value:
 - ‘DAKVDEFFXXX’ (CBF’s BIC code)
 - Payment type code, with the value:
 - ‘FREE’: free of payment
 - Transaction identification, with the values:
 - ‘OWNE’: external account transfer
 - ‘OWNI’: internal account transfer
- Matching status, with the value:
- ‘MACH’: already matched settlement instructions

Cross-CSD Impact Analysis

Impact on Investor CSD account configuration

Investor CSDs may also have “Registered Positions” on their omnibus account, i.e. positions which are earmarked with position types “RSHB” or “RSKE” (whereas positions which are not registered – so-called “Freier Meldebestand”- are reflected in “AWAS”). Therefore, these position types and related controls described in the above section are also applicable to Investor CSDs.

In case Investor CSDs want to register securities they hold with CBF, they need to request CBF to register certain positions with the corresponding registrar (through MT500, i.e. outside the scope of T2S). Subsequently, CBF will earmark the registered positions on their omnibus account in a specific position type “RSHB”. Investor CSDs are advised to reflect this segregation in their books to ensure consistency of securities positions and make sure that registered securities are not used for settlement before being de-registered, as cross-CSD settlement would fail due to lack of securities on the omnibus account but intra-CSD settlement at the Investor CSD would not be prevented. This can be achieved by segregation by position types (like CBF) or separate accounts. This also holds true for “RSKE” positions, which will be used. Investor CSDs do not need to implement the MSA defined by CBF on securities account level for this purpose but may want to consider implementing the MSA at securities account level to distinguish those CBF shares subject to registration duty.

Impact on Investor CSD Settlement Flows

In case of cross-CSD transaction in CBF registered securities, the securities first need to be de-registered. This is materialised by a transfer from “RSHB” to “AWAS” (held free) position type. Investor CSDs can trigger this process by sending already matched instructions free of payment directly on their omnibus account (i.e. as a participant of CBF), which will be put on CSD Validation Hold. Once CBF has updated its internal systems to reflect the de-registering of the position, the instructions will be released for settlement, and the positions available (i.e. in “AWAS”). Investor CSDs having segregated registered securities positions from available positions will need to reflect this de-registration in their account structure in a second step (i.e. move the positions back to “AWAS”). At this stage, de-registered securities would be available for settlement as any other securities, and do not need immediate re-registration.

In case of intra-Investor CSD transfer of registered securities (linked to the same omnibus account in CBF), this process can be simplified by instructing a special “internal account transfer” instruction to CBF in ICP mode, in which case no settlement takes place on the omnibus account of the Investor CSD in CBF (i.e. no movement from “RSHB” to “AWAS” and vice versa) and the new owner of the securities is registered in CBF’s dedicated application.

As outlined earlier, in case Investor CSDs want to register securities they hold with CBF, they need to send a message in ICP mode (MT500, outside of the scope of T2S). Once the securities are registered, this will be reflected on the omnibus account as an earmarked position “RSHB”, and Investor CSDs having implemented segregation for registered securities will need to reflect this (re-)registration in their account structure (i.e. move the positions back to “RSHB” or restricted account for registered securities).

Investor CSDs of CBF servicing registered securities need to consider the following requirements:

- Keep an ICP connection to CBF in order to transmit a registration request (MT500)
- Implement an MSA on securities level, in order to distinguish securities subject to registration duty from regular securities, as outlined in the German Law
- Implement segregation of securities positions and restriction rules as registered securities cannot settle STP in case of cross-CSD transactions

4.2.2 ESES (Euroclear Belgium, Euroclear France, Euroclear Netherlands)⁶⁷

Euroclear Belgium

Pre T2S – Process Controls

In the case of Belgian registered securities, i.e. securities positions are primarily maintained in the issuer register, while Euroclear Belgium keeps an electronic reflection of the issuer’s register through its

⁶⁷ The section below describes the registration processes and analysis of restriction rules for Euroclear Belgium and Euroclear France. From a strict technical standpoint, all restriction rules are implemented in the 3 ESES CSDs.

dedicated platform called ‘BRS’⁶⁸. It is the registrar who confirms the eligibility of end investors (i.e. at beneficial owner level) to hold registered shares. The CSD only offers settlement services for these securities when traded on the stock exchange (Euronext Brussels), i.e. acts at settlement agent level, and in this context ensures that the registration of securities is completed along with settlement based on the provision of registration related documentation by the selling and buying parties. The stock exchange related settlement transaction is blocked (i.e. put on hold) until all the required documentation related to registration has been validated and accepted by the registrar (see below the depiction of stock exchange transactions and related registration process at Euroclear Belgium).

As regards OTC transactions, settlement is not performed by the CSD and positions are updated directly in the registrar’s books at beneficial owner level.

Currently, this procedure is foreseen for a very limited number of securities with low trading activity (3 ISINs, average volume of transactions is 4500 per year, 0.18% of yearly transactions). No cross-CSD activity is envisaged for such securities.

Adapted State – Process Controls

The existing registration process implemented at Euroclear Belgium will be reflected for the settlement of registered securities in T2S between the buying and selling parties acting as settlement agents. The CSD will provide settlement services for Stock Exchange flows on these securities, and only a global holding position will be maintained in T2S, i.e. investor positions are solely reflected in the registrar’s books. OTC flows will not be settled in T2S. Settlement transactions on Belgian registered securities will be instructed by the CSD Euroclear Belgium upon reception of the trade feed from the Stock Exchange, and will require the implementation of a restriction rule in T2S, in order to ensure that settlement is only performed when all relevant information is received from the buying and selling parties, and the registrar is updated jointly to the settlement⁶⁹. As from the moment the registrar is duly updated, no more positions remain in T2S at settlement agent level.

The restriction rule defined by Euroclear Belgium aims at preventing STP settlement instructions on Belgian registered securities, unless the CSD is Instructing Party:

Case 1 Restriction Type: Positive CSD Validation Hold

- RT15 (ESE-046-REG) – This control ensures that settlement instructions on Belgian registered securities are put on hold, unless instructed by Euroclear Belgium (as Instructing Party).

The parameters configured in the rule are listed below:

Party type of the instructing party:

- ‘CSD Participant’

⁶⁸ In the medium term horizon (2025), these securities will have to be dematerialised or immobilised according to the Article 3 of the CSD Regulation

⁶⁹ The BRS system is an electronic system held at Euroclear Belgium mirroring the positions of the register at the issuer

- 'External CSD'

Security:

- ISINs representing Belgian registered securities

Figure 14 - Connecting 'Belgian registered shares' system to T2S

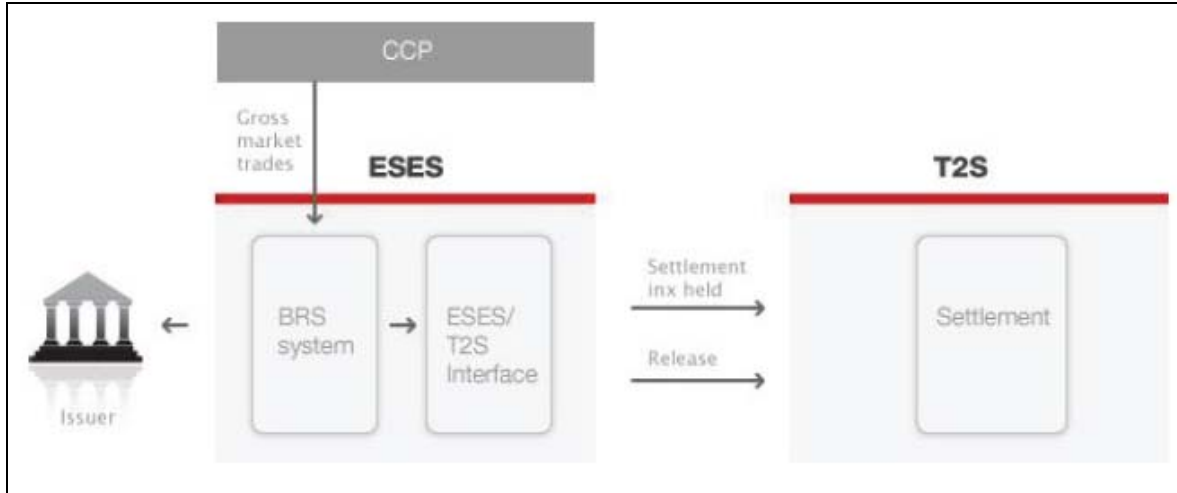

Cross-CSD Impact Analysis

Impact on Investor CSD account configuration

A dedicated Account Nature (NDC104) needs to be opened by each CSD participant for the purpose of settling Belgian Registered Securities. This requirement would also apply to Investor CSDs in case they would act as settlement agent for Belgian registered shares.

Impact on Investor CSD Settlement Flows

Euroclear Belgium will receive a direct trade feed from Euronext regarding transactions on Belgian registered securities and send settlement instructions directly to T2S. It is unclear how Investor CSDs would be involved in the process of Belgian registered securities, as the eligibility to hold the securities is decided by the registrar, and the Stock Exchange flows (trade feed received by Euronext) prevent any active role of Investor CSDs in the settlement process.

Note: as from the moment the registration is done at issuer level, no more positions are reflected in T2S at settlement agent level.

It must be stressed that the practical impact on Investor CSDs appears very limited, given the few ISINs and limited appeal of Belgian registered securities for foreign investors (BRS are non-standardised securities traded amongst Belgian participants only and represent a low volume of transactions).

Euroclear France

Pre T2S – Process Controls

In order to understand the needs related to the processing of registered securities in the French market, the following concepts need to be explained, as regards the distinction between registered securities, communication channels, and channel and intermediaries involved.

Need for registration (VEN vis-à-vis VON)

VEN ‘Valeur Essentiellement Nominative’ (means registered securities) means that a company can only issue registered securities and is governed by the article of laws of the company or the law for certain sectors like defense.

VON “Valeur Occasionellement Nominative” means that the securities are issued under bearer form and can be registered on demand on the shareholder.

For both types of registration, the issuer (or issuer agent) is responsible for the management of the register of shareholders which holds the name, the security balance, the address and any mandatory information of the owner of security.

Shareholder and Issuer communication (Nominatif Pure vis-à-vis Nominatif Administré)

Irrespective of the need for registration (on demand versus mandatory), the shareholder may opt to hold registered securities in an account opened with a financial intermediary (such as custodian bank) and for all communication with the issuer, the shareholder must use the financial intermediary’s services only. This operating model is known as ‘Nominatif Administré’.

For the ‘Nominatif Pur’ operating model, there is no intermediary between the shareholder and the issuer. The shareholder is allowed to send its instructions directly to the issuer, in charge of the execution of trades on the market through a broker. All shares in ‘Nominatif Pur’ form must be converted into bearer form to permit trading and settlement. For both operating models, the ownership is reflected in the books of the company by the registrar services. If the date of the settlement is the date of transfer of ownership rights (the registration date), the name in the register is the owner of the security. This requirement is the main reason for the strict regime in France for registered securities and movement of securities between Account Natures is validated to avoid any discrepancy between settlement (and securities holdings) and register maintenance. This requirement is defined in the French Law through the Article 322-53 of RG AMF, which imposes that bearer and registered securities are segregated.

Settlement of registered securities

For VON model (i.e. on demand registration), securities trading and settlement is done in the bearer form only. Since the registration is ‘on demand’ based upon the request of the shareholder, financial intermediaries receiving instructions for sale of registered securities must convert the registered securities into the bearer form. A key element to emphasise is that the conversion does not involve a change of ISIN, i.e. the same ISIN is kept whether the security is in bearer or registered form. The process of conversion from registered to bearer form requires an FOP movement between Account Nature

'Administered registered securities' (001) to Account Nature 'Ordinary securities' (000)⁷⁰. Similarly, from the buyer's perspective, the registration of the purchased bearer form securities requires an FOP movement by the intermediary from Account Nature 000 to Account Nature 001. The registration process is initiated after the settlement of trade and upon the request of investor. This registration procedure is applicable for 'Nominatif Administered' operating model because instructions are managed via the intervention of a financial intermediary. All FOP movements transferring securities between the Account Natures 001 versus 000 of the same participant do not require any additional validations. For 'Nominatif Pur' operating model, the Account Nature 'Accounts for issuer registered securities' (009) is applicable and the investor sends the instruction directly to the issuer. However, the sale of securities follows the same principle as applicable in case of Nominatif Administré', the issuer (registrar services) must transfer the securities from the Account Nature NDC09 of the Issuer reflecting the fully registered position to the Account Nature NDC00 of a broker to sell the securities (and vice versa for the purchase). For VEN model, the conversion from registered to bearer form is not required because the securities can exist in the registered form only (e.g. a share cannot be held in the 'Ordinary securities' 000 Account Nature).

For corporate actions or new issuance, Euroclear France allows the debit of underlying CA ISIN or credit of outturn ISIN as long as the postings are made on eligible accounts or position types dedicated for registered securities (e.g. Euroclear France).

Concept of registered intermediary in Euroclear France

'Registered Intermediary' ('Intermédiaire Inscrit') is a legal concept described in the French 'Code de Commerce' for foreign custodians or CSDs whereby the intermediary is allowed to send BRN in their name, without specifying the underlying investor, as long as it is not a French resident. The Investor CSD acts as nominee for the French registered shares and therefore only supports the registration and deregistration process into the share register in the context of cross border settlements. For any delivery of securities into the French market, the Investor CSD is deleted from the share register as nominee while the counterparty in Euroclear France will be registered. This registration and deregistration process is not necessary for internal transfers at Investor CSDs, that is between two counterparties within the same Investor CSD.

Adapted State – Process Controls

Euroclear France will adapt the existing Account Natures in ESES to T2S using a Market Specific Attribute (MSA) defined at securities account level. Each securities account opened in T2S will be assigned a specific MSA value indicating the Account Nature. All the restriction rules implemented for registration aim at ensuring that the registered securities are settled via the eligible securities accounts

⁷⁰ The conversion of securities from NDC 001 to NDC 000 can entail the loss of specific privileges for the shareholder.

(identified by MSA). Since none of the rules require the instruction to be on CSD Validation Hold until other processes or validations are complete, it implies that the registration and settlement process are independent.

Figure 15 - Processing French registered shares on the T2S platform

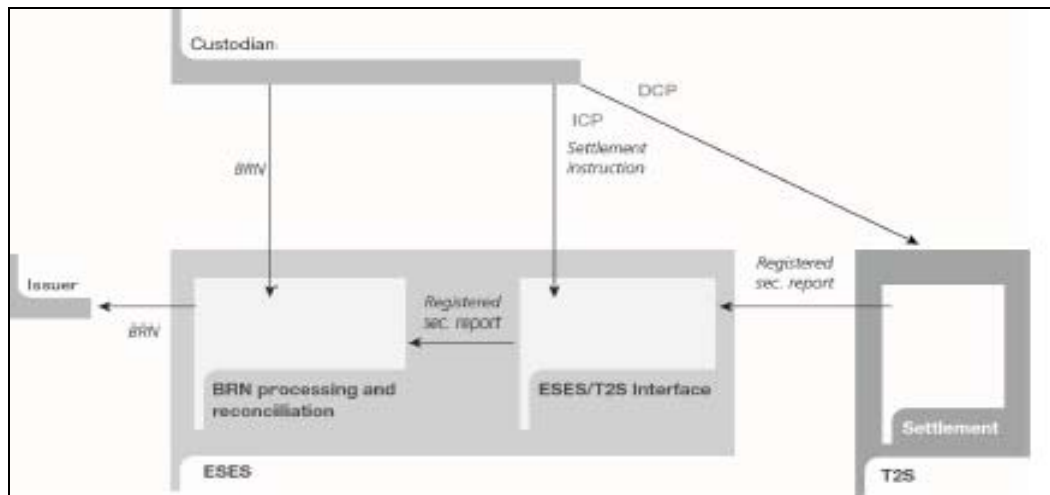

ESES has defined the following restriction rules in T2S:

Case 1 Restriction Type: Positive Rejection

- RT02 (ESE-002-REG): This control ensures that delivering settlement instructions against payment, sent by CSD participants are rejected when debiting⁷¹ the dedicated Account Nature (045).

The parameters configured in the rule are listed below:

Account nature (MSA on securities account):

- 'Registered securities issued from a corporate action currently being registered with the issuer' (045)

Securities Movement Type:

- 'DELI'

Payment type code:

- 'APMT'

Party Type of the Instructing Party:

- 'CSDP'

⁷¹ This is achieved through specifying the Market-Specific Securities Account Attribute as 'DEBIT' in the rule configuration

- RT05 (ESE-015-REG): This control ensures the compatibility between the Account Nature (debit or credit) of the securities account (MSA) and the security category (MSA).

The parameters configured in the rule are listed below:

Account nature (MSA on securities accounts):

- 'Underlying securities for certificates of deposit (Caisse nominative)' (061)
- Security category (MSA on securities):
- 'Domestic dematerialised security except drawing'

- RT07 (ESE-035-REG): This rule ensures the compatibility between the 'legal form of the security' (MSA) and the 'Account Nature' (MSA) of the account. The main purpose is to check that registered securities transactions are held on authorised accounts to guarantee reliable information to issuers: accounts dedicated to specific instruments are actually used for related legal form of security.

The parameters configured in the rules are listed below:

Legal form of security (MSA on securities):

- 'Registered' (2)

Account nature (MSA on securities account):

- 'Ordinary Securities' (000)
- 'Bearer securities distributed to employees by their company' (004)
- 'Bearer securities account excluded from direct payment' (015)
- 'Bearer securities distributed to employees by their company' (004)
- 'Direct payment on bearer securities without commission' (014)
- 'Bearer securities account excluded from direct payment' (015)
- 'Foreign companies' securities presented for exchange offer or odd-lot offer' (050)
- 'Bonds presented for early redemption and securities from Belgian, French or Dutch companies presented for acquisition or tender offer' (052)
- 'Coupons or rights to be paid in cash' (55)
- 'Coupons or rights to be exchanged against securities' (56)
- 'Bearer securities presented for a mandatory conversion into registered securities' (58)
- 'Stripped securities' (60)
- 'Underlying securities for certificates of deposit ' (061)
- 'Local transfer agent on foreign securities' (64)
- 'Total issued amount of stripped securities' (78)

- 'Coupon paid in non-Euro currency' (79)
- 'Securities that have been blocked due to non-presentation of the certificate' (86)
- 'Securities in physical form' (91)
- 'TCN issuing account' (92)
- 'Physical securities that are lost on non-dematerialised securities' (93)
- 'Physical securities with unknown owner' (094)
- 'Typical certificates in traffic' (095)
- 'Typical certificates out of traffic' (96)
- RT07 (ESE-036-REG): This rule ensures the compatibility between the 'legal form of the security' (MSA) and the 'Account Nature' (MSA) of the account. The main purpose is to check that transactions on bearer securities are held on authorised accounts to guarantee reliable information to issuers, and that accounts dedicated to specific instruments are actually used for related legal form of security.

The parameters configured in the rule are listed below:

Legal form of security (MSA on securities):

- 'Bearer' (3)

Account nature (MSA on securities account):

- 'Administered registered securities' (001)

- RT7 (ESE-040-REG): This rule ensures the compatibility between the 'legal form of the security' (MSA) and the 'Account Nature' (MSA) of the account. The main purpose is to check that securities deposited in EBE or ENL (domestic or foreign) transactions are held on authorised accounts to guarantee reliable information to issuers, and that accounts dedicated to specific instruments are actually used for related legal form of security.

The parameters configured in the rule are listed below:

Legal form of security (MSA on securities):

- 'Securities deposited in EBE or ENL (domestic or foreign)' (7)

Account nature (MSA on securities account):

- 'Administered registered securities ' (001)
- 'Bearer securities distributed to employees by their company ' (004)
- 'accounts for registered securities' (008 or 009 or 017)
- 'Securities to be converted to mandatory registered form' (044)

Restriction Type 1: Positive CSD Validation Hold

- RT18 (ESE-047-REG): This control puts on CSD Validation Hold settlement instructions between administered registered securities account and ordinary securities account for securities with legal form “Bearer or registered” sent by CSD participants or external CSD (Instructing Party), as prior to such transfer, the transfer of ownership and shareholders’ details must be sent to the issuer agent to process registration or de-registration. Instructions are released after the CSD has performed the checks in its system.

The parameters configured in the rule are listed below:

Account nature (MSA on securities account):

- ‘Administered registered securities’ (001)

Legal form (MSA on securities):

- ‘Bearer or registered’ (0)

Party type of the instructing party:

- CSD participant
- External CSD

- RT18 (ESE-048-REG): This restriction rule puts on CSD Validation Hold settlement instructions with Account nature ‘Registered securities (employees shareholding)’ or ‘Accounts for issuer registered securities’ if instructing party is a CSD participant or external CSD (Instructing Party). The parameters configured in the rule are listed below:

Account nature (MSA on securities account):

- ‘Registered securities (employees shareholding)’ (008)
- ‘Accounts for issuer registered securities’ (009)

Party type of the instructing party:

- CSD participant
- External CSD

Restriction Type 1: Negative CSD Validation Hold

- RT17 (ESE-055-REG): This restriction rule creates an exception to rule RT18 (ESE-047-REG) and ensures that settlement instructions on a security with Legal Form (MSA) ‘Bearer or Registered’ on Account Nature (MSA) ‘Administered registered securities’ (001) are not put on CSD Validation Hold if instructed with the ‘OWNE’ ISO transaction code. The usage of this code is controlled by access rights.
- RT17 (ESE-056-REG): This restriction rule creates an exception to rule RT18 (ESE-048-REG) and ensures that settlement instructions on Account Natures (MSA) ‘Registered securities

(employees shareholding)' (008) and 'Accounts for issuer registered securities' (009) are not put on CSD Validation Hold if instructed with the 'OWNE' ISO transaction code. The usage of this code is controlled by access rights.

Cross-CSD Impact Analysis

Impact on Investor CSD account configuration

The use of distinct securities accounts categorised for (fully and administered) registered and bearer securities settlement also requires the segregation of holdings in the Investor CSD's omnibus accounts. The ESES planned solution for mapping the participants' current account structure to the T2S accounts involves the configuration of an MSA for securities accounts to specify dedicated type of holdings. All participants of Euroclear France including Investor CSDs will have to segregate their French registered holdings to a specific T2S account. This implies that omnibus accounts of Investor CSD will also be qualified to hold French registered securities based on the value of the MSA on the omnibus account.

However, the need for account segregation in Investor CSD is conditional upon the provision of services for both registered and bearer forms of the security by the Investor CSD.

In short, the Account Nature 'Ordinary Securities' (000) will be opened by default for Investor CSDs, while the Account Nature 'Administered registered securities' (001) will be opened for those Investor CSDs servicing registered securities of Euroclear France, be it VEN or VON⁷².

Note that Investor CSDs reflecting 'legal' or 'holding' forms of securities (MSA) according to ESES' specifications must segregate holdings of their clients in their books accordingly and implement the related restriction rules which apply to Account Natures 000 and 001. This approach may bring complexity to the segregation of securities holdings within the Investor CSD.

Figure 16 - Segregation of accounts in Investor CSD A books

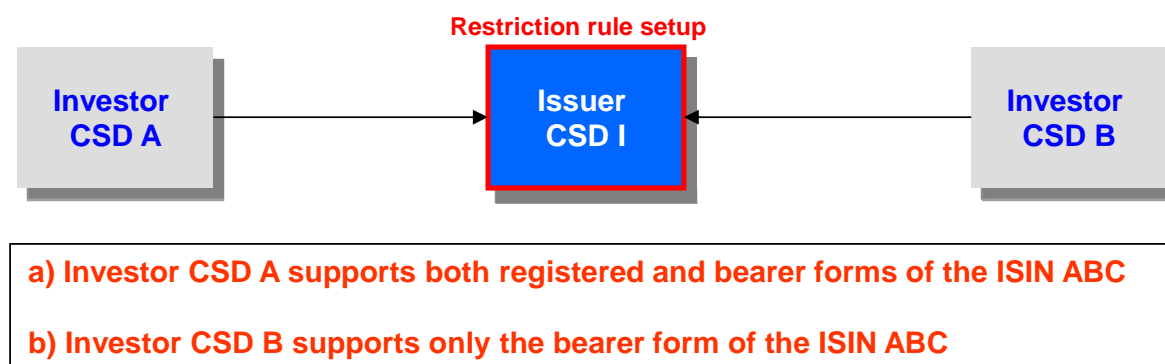

⁷² The fact that VON can be in bearer or registered form, without exchange of ISIN, is believed to be the origin for the segregation requirement of bearer and registered securities on different accounts (as mandated by the French Law Article 322-53 of RG AMF).

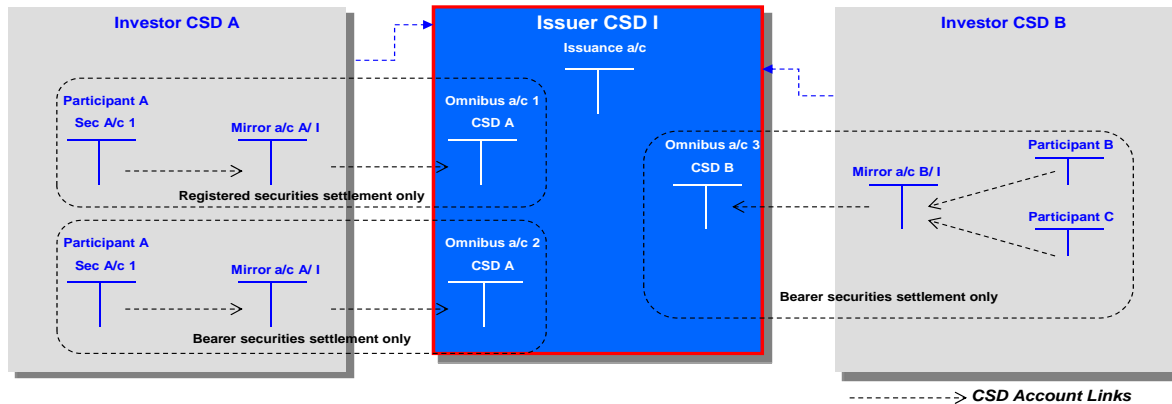

To provide details of the impacts at the level of each restriction rule;

- For the rules RT02 (ESE-002-REG), RT05 (ESE-015-REG), no impact on Investor CSDs’ account configuration has been identified, as none of the Account Natures triggering the rejection are available to Investor CSDs.
- For the rules RT07 (ESE-035-REG), RT07 (ESE-036-REG), RT07 (ESE-040-REG), RT18 (ESE-047-REG), RT18 (ESE-048-REG), RT18 (ESE-055-REG), RT18 (ESE-056-REG), Investor CSDs holding both Account Natures 000 and 001 shall segregate holdings in their books according to the requirements of Euroclear France and implement the related restriction rules.

Impact on Investor CSD Settlement Flows

The impact of Euroclear France’s restriction rules on Investor CSDs’ settlement flows is limited to settlements involving Euroclear France as either an intermediary CSD between the buyer and seller CSDs or as the counterparty CSD (buyer / seller).

All instructions on the Investor CSD’s omnibus account irrespective of their origin (sent by T2S actor or generated by T2S) are subject to the restriction rules for registered securities settlement to ensure compliance between type of securities and eligibility of the omnibus account to hold the security type. Since these restriction rules may result in a non-generation of the T2S generated realignment instructions⁷³ in specific cross-CSD settlement scenarios, Investor CSDs and their participants settling registered securities are exposed to the risk of receiving acceptance status advice for Business Instructions followed by cancellations from T2S and should therefore implement restriction rules of ESES involving segregation of securities positions on Account Natures 000 and 001.

The example below illustrates this situation:

⁷³ UDFS version 2.0: Validity of T2S generated realignment Settlement Instructions (p. 375)

Figure 17 - Cross-CSD settlement based on VEN registration scheme (participant accounts are mapped to different omnibus accounts at Euroclear France)

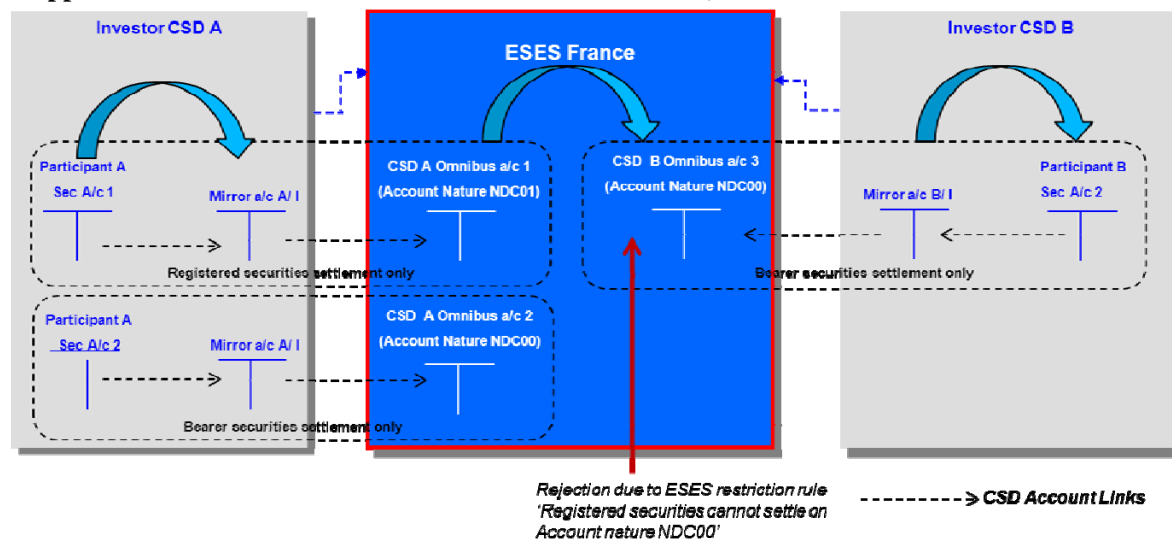

Scenario: Cross-CSD transaction between two Investor CSDs where realignment between omnibus accounts takes place at the Issuer CSD (registration related restriction rules). The participants at Investor CSD settle securities based on VEN registration scheme (securities exist in registered form only) and the delivering and receiving securities accounts mapped to different omnibus accounts (Account Nature 001 and 000), i.e. Investor CSD B holds an account for bearer securities only.

Findings: In this scenario, T2S creates realignment instructions on the omnibus accounts of CSD A and CSD B in Euroclear France. The delivering omnibus account is assigned the MSA value 001 corresponding to the Account Nature eligible for holding registered securities whereas the receiving omnibus account is assigned the MSA value 000 corresponding to the Account Nature for holding bearer form securities only.

The restriction rules set-up by Euroclear France will not allow the creation of realignment instructions on the omnibus account mapped to Account Nature 000 for VEN. This will result in a cancellation of Business Instructions at both Investor CSDs (i.e. CSD A and CSD B) after their initial acceptance.

To prevent this situation, the Investor CSD B will need to propagate the ESES restriction rules and related MSA corresponding to ESES Account Natures. This will result in the earlier rejection of the Business Instruction at the Investor CSD B, at the time of initial validation, before the matching process has taken place.

In the case of VON, securities can be freely transferred when in bearer form. However, a change of form of these securities implies a movement from the Account Nature 000 to Account Nature 001 or vice versa. Settlement instructions effecting such transfer will be put on CSD Validation Hold in Euroclear

France, except if the transfer is between 2 accounts of the same participant, and a special transaction code 'OWNE' is used⁷⁴.

To provide details of the impacts on settlement flows at the level of each restriction rule (with the assumption that the rules are not implemented by Investor CSDs in their own structure);

The rules RT02 (ESE-002-REG), RT05 (ESE-015-REG), do not need to be replicated by Investor CSDs, as none of the Account Natures triggering the rejection are available to Investor CSDs:

- For a cross-CSD transaction between an ESES participant whose Business Instruction is matching the rule parameters and a participant of an Investor CSD, the Business Instruction of the ESES participant will be rejected while the Business Instruction of the Investor CSD will remain unmatched. No realignment will be created for this transaction.
- In other cross-CSD scenarios generating realignments at ESES (i.e. between Investor CSDs' participants or a participant of ESES and a participant of an Investor CSD), the realignment instructions will not be impacted by the rule and the transaction can be eligible to settle.

Investor CSDs holding both Account Natures 000 and 001 should consider implementing the rules RT07 (ESE-035-REG), RT07 (ESE-036-REG), RT07 (ESE-040-REG), RT18 (ESE-047-REG), RT18 (ESE-048-REG), RT18 (ESE-055-REG) and RT18 (ESE-056-REG). Settlement flows would be impacted as follows:

- For a cross-CSD transaction between an ESES participant whose instruction is matching the rule parameters and a participant of an Investor CSD, the Business Instruction of the ESES participant will be rejected while the Business Instruction of the Investor CSD will remain unmatched. No realignment will be created for this transaction.
- In other cross-CSD scenarios generating realignments at ESES (i.e. between Investor CSDs' participants or a participant of ESES and a participant of an Investor CSD), the rejection rule can be triggered on the realignment instructions, resulting in the Business Instructions being accepted, matched, then cancelled.

Conclusion

While many European markets have implemented procedures for registration of securities, the controls and processes required to perform registration are quite different among CSDs, the actors involved in the registration procedures and the dependency with the settlement process vary across markets. In addition, registration procedures are defined according to specificities and long-standing practices unique to each market. In the context of this analysis, it results in different restriction rules being implemented by CSDs in their role as Issuer CSD.

⁷⁴ Whenever the transaction involves an Investor CSD, the transaction will systematically be put on CSD Validation Hold as realignment instructions always contain the ISO transaction code 'REAL'.

The registration procedures and restriction rules defined by CBF will impact Investor CSDs' account structure and settlement flows, if they decide to service registered securities. Registered securities are segregated in a specific position type in CBF which will also apply to Investor CSDs' omnibus accounts. Registration requests need to be sent directly to CBF through a messaging channel outside of T2S scope (MT500). Once they are un-registered, securities can settle STP, although they are subject to registration duty according to the German Law, but only within a "reasonable timeframe". To achieve the required level of control, Investor CSDs should consider whether to implement segregation of securities positions, restriction rules, and MSA on securities level in order to distinguish those securities subject to registration duty.

In Euroclear France, segregation of securities positions will be required to distinguish between registered and non-registered securities and the restriction rules related to this segregation should be considered by Investor CSDs. This will ensure that validations are performed on the Business Instructions of Investor CSDs rather than at the level of realignment, where settlement instructions may become cancelled after initial acceptance and matching. Not doing so, Investor CSDs would run the risk, in the case of intra-CSD transactions, of a discrepancy between actual and registered owner of a security (and inability to exercise rights attached to the security for the actual owner). To achieve the required level of control, Investor CSDs should also consider implementing the relevant MSAs on securities and securities account level, albeit with a limited set of values. In the case of securities where registration is done on demand (VON)⁷⁵, securities can only be traded in bearer form. Any change in the form of the security will result in a transfer between the administered registered and bearer securities account types. Such transfer will be put on hold and only be released by the CSD once the de/re-registration process is successfully confirmed by the issuer agent.

Finally, in Euroclear Belgium, securities positions are primarily maintained at the registrar and not at the CSD, i.e. such positions are not reflected on T2S participants' accounts⁷⁶. CSD participants can only provide settlement services for those securities, if traded on the Stock Exchange (OTC transactions are not settled at the CSD). Euroclear Belgium maintains an interface with the issuer, and has implemented a restriction rule to ensure consistency of shareholders' positions in the register with settlement in T2S.

It is unclear at this stage how Investor CSD participants could act as settlement agent for these securities, and thus how Investor CSDs could offer such service in Belgian registered shares. The eligibility to hold these shares is decided by the issuer. However, in practice, the impact from this restriction originating from the registrar is strongly mitigated due to the fact that the limitation just

⁷⁵ The same ISIN represents the security in either bearer or registered form

⁷⁶ Euroclear Belgium maintains a global position of Belgian registered securities in T2S which is mirroring the registrar position. In the medium term horizon (2025), these securities will have to be dematerialised or immobilised according to the Article 3 of the CSD Regulation

concerns 3 non-standardised ISINs with little trading activity (around 4500 trades per year, 0.18% of yearly transactions).

4.3 Taxation

Introduction

For the assessment of restriction rules according to the methodology defined in Section 2.2 “Methodology to quantify impacts on Investor CSDs”, Taxation is categorised as a necessary service from an Investor CSD’s standpoint. Indeed, Investor CSDs must comply with the fiscal requirements and processes (e.g. withholding tax) defined within the Issuer CSD’s jurisdiction.

The taxation process in the context of securities settlement involves withholding tax on securities income (such as dividends and interest) and applies to both resident and non-resident investors of the market where securities income is sourced.

Withholding tax is defined as the ‘Tax on income from securities and securities transactions’⁷⁷. The party responsible for the tax processing differs across European markets. For some markets, it can be the Issuer CSD that directly debits withholding tax from the participant’s cash account, as it is the case in NBB-SSS. In some other cases, the Investor CSD or the CSD participant that has a withholding status is responsible to interact with the local tax authorities, e.g. in Italy. Finally, the end-investor himself can be responsible for its tax payment via the regular tax declarations. All in all, the European market is fragmented with regards to the party (individual or legal entity) that has to perform the tax processing.

Withholding tax relief is defined as the ‘(Partial) Exemption from tax available under domestic law or pursuant to double taxation treaties’⁷⁸. The tax relief procedures also vary across the EU markets and are categorised as ‘at-source relief procedure’ and ‘refund or reclaim procedures’:

- ‘At-source relief’ method involves the provision of tax relief during the payment of securities income (i.e. dividend or interest). The withholding tax procedures based on ‘at-source relief’ are preferred due to the optimised cash flow offered to the investors. For some cross country investors, some markets may have implemented bilateral double taxation agreement (DTA) to provide (partial) relief on the tax to be paid
- ‘Refund or reclaim’ method involves the deduction of tax at source (i.e. during payment of securities income) followed by the submission of reclaim request by investor. This is not considered as the preferred tax relief method due to the time value of money cost, varying reclaim time frames across EU and mandatory documentation requested by the tax authorities for every reclaim request as opposed to tax relief at source that allows for one time documentation. The tax reclaim is considered as a critical activity and according to the study carried out by European Commission, costs related to

⁷⁷ Referenced from http://ec.europa.eu/taxation_customs/taxation/personal_tax/taxation_securities/index_en.htm

⁷⁸ Referenced from http://ec.europa.eu/taxation_customs/taxation/personal_tax/taxation_securities/index_en.htm

current reclaim procedures are estimated at a value of €1.09 billion annually, whereas the amount of foregone tax is estimated at €5.47 billion annually⁷⁹.

For markets wherein the CSDs (Issuer or Investor) act as the withholding tax agent and have implemented ‘at-source relief’ procedures, special controls can be designed by the CSDs to meet the taxation related eligibility criteria for holding and settling specific securities on certain securities accounts.

Other CSDs implement controls in the form of segregation and restriction rules as a result of the tax laws governing certain countries. The next sections focus on the description of current controls and future restriction rules that CSDs plan to put in place in the context of taxation, and analyse their impact on cross-CSD settlement.

4.3.1 Iberclear

Pre T2S – Process Controls

According to the Italian taxation rules for gross tax payers not resident in Italy, no tax deduction is performed at source for the income from Italian bonds, provided the persons are resident in countries that provide an adequate exchange of information (‘White List’ of countries). The ‘White List’ includes Spain and requires that Iberclear, as Investor CSD of Monte Titoli, is able to identify all legal entities and individuals in its books owning Italian bonds. In this context, Iberclear provides the information regarding the holdings and settled instructions of its participants on a monthly frequency to the Italian Ministry of Finance. In order to do so, the following control is implemented by Iberclear:

- Italian Bonds are not allowed to be held on non-proprietary securities accounts. This implies that only direct participants with proprietary accounts can hold Italian bonds.

Adapted State – Process Controls

For taxation purposes, the following rule has been defined by Iberclear as Investor CSD of Monte Titoli:

- “RITO”, a positive rejection (Case 1 Restriction Type) rule. The rule is defined to reject all settlement instructions on a specific Italian ISIN (identified with MSA) on an omnibus third party Iberclear security account (identified with MSA).

The parameters configured in the rules are listed below:

- “Account Type”, an MSA on securities account level to identify which MSA securities account values will trigger the rejection of a settlement instruction, with the value:
 - “TOEX” (non-proprietary accounts)
- “Securities Type”, an MSA at the level of securities to identify which MSA securities values will trigger the rejection of a settlement instruction, with the value:

⁷⁹ Simplified withholding tax procedures from DG Internal Market and Services 2010

- “ITO” (Italian Bonds)

Cross-CSD Impact Analysis

Impact on Investor CSD account configuration

Note: The Italian Ministry of Finance does not mandate the implementation of any specific solution for adherence to the legal reporting requirements for Italian bonds. CSDs in other markets included in the White List may have implemented other solution(s) to ensure compliance. The assessment of other implementation models for reporting on Italian bonds holding is not in the scope of this analysis.

Iberclear will not perform the role of a Technical Issuer CSD for Italian bonds in T2S. The control implemented by Iberclear stems from a business decision to ensure compliance with the legal reporting requirements of the Italian Ministry of Finance.

As a result of this decision, omnibus accounts of Investor CSDs at Iberclear will never hold Italian bonds. This implies that Iberclear’s restriction rule for Italian bonds processing will not require segregation of accounts at Investor CSDs.

Impact on Investor CSD settlement flows

Since Iberclear will not perform the role of Technical Issuer CSD for Italian bonds, settlement of Italian bonds involving Investor CSDs will not be possible. As a result, it would only be in the case of erroneous cross-CSD transaction from an Iberclear participant delivering Italian bonds to a participant of an Investor CSD that the restriction rule would be triggered, either on the Business Instruction of the Iberclear participant if the counterparty account was indicated in the settlement instruction, either upon matching on the realignment instructions generated by T2S, resulting in Business Instructions being cancelled after acceptance and matching.

4.3.2 NBB-SSS

Pre T2S – Process Controls

NBB operates a securities settlement system for debt securities called ‘X/N system’⁸⁰. A key feature of the X/N system is the special Belgian withholding tax rule whereby investors are required to hold securities either on an exempt account (X-account) or a non-exempt account (N-account). This depends upon the investor’s withholding tax status.

- Non-residents of Belgium and all Belgian companies are entitled to hold their securities on an X-account (exempt account). The interest earned on securities held on X-accounts is exempt from Belgian withholding tax.
- Belgian resident individuals and most Belgian non-profit organisations are required to hold their securities on an N-account (non-exempt account). The interest on securities held on N-accounts is subject to 25% Belgian withholding tax, which is deducted and paid to the Belgian treasury.

⁸⁰ Referenced from Annexes to the regulations of the Securities settlement system of the National Bank of Belgium, Jan 2011

Holding debt securities through the X/N system enables X-account holders to receive gross interest income on their securities and to transfer the securities on a gross basis. NBB-SSS follows “pro rata temporis” withholding system for interest bearing securities, whereby tax is levied at source on the interest accrued upon each transfer of the securities between interest payment dates.

The following controls are put in place in the context of taxation by NBB-SSS:

- Securities exempt from withholding tax cannot be held on N-account
- By Article 12 of Royal Decree, borrowing of securities, repurchase agreements, swap of securities, and exchange of securities cannot be performed with securities booked on an N-account.
- By Article 8 to 11 of Royal Decree, the calculation of withholding tax on ISD must be done for all instructions on N-account, if the quantity of securities delivered or received is not zero.

Adapted State – Process Controls

The restriction rules defined by NBB for implementation of current controls in X/N system are based on two MSAs for securities and securities accounts. The use of MSAs is required as T2S does not store the taxation attributes of securities and securities accounts.

The MSA on securities account level is based on the combination of two account attributes:

- A type of account from Belgian fiscal point of view combined with type of account in terms of holder type:
 - Belgian Tax Status: Subject to withholding tax(‘N’) and Exempt from withholding tax (‘X’)
 - Holder Type: Own account (‘0’), Client account (‘1’), Pledge account (‘2’) and Issuance accounts (‘3’)

The MSA values defined at securities account level are a combination of the above attributes, namely: “X0”, “X1”, “X2”, “X3”, “N1”, “N2”

The MSA on securities is based on the limitations (according to the Royal Decree of 1994) applicable for a security according to the Belgian Fiscal point of view, with the following values:

- ‘0’: Security not allowed in X/N system
- ‘1’: Full XN, security is not exempted
- ‘2’: X only, security exempted from withholding tax
- ‘3’: Security is not subject to withholding tax at transaction time

Restriction Rules in T2S

- “NBBE-RT01”, a positive rejection rule (Case 1 Restriction Type), will be implemented in order to:
 - Reject all settlement instructions on non-exempt client securities accounts (MSA value N1) and non-exempt pledge securities accounts (MSA value N2) when security exempted from withholding tax (MSA value 2);

- Reject all settlement instructions on non-exempt client securities accounts (MSA value N1) and non-exempt pledge securities accounts (MSA value N2) when ISO transaction code is REPU, REPO, RVPO and RVPU is used
- “NBBE-RT02”, a positive CSD Validation Hold rule (Case 1 Restriction Type), will be implemented in order to:
 - Put on CSD Validation Hold all settlement instructions from CSD participants on non-exempt client securities accounts (MSA value N1) when the security is not exempted from withholding tax (MSA Value 1);
 - Put on CSD Validation Hold all settlement instructions from CSD participants on non-exempt pledge securities accounts (MSA value N2);

Note: this particular control on non-exempt pledge securities accounts is analysed in the context of the business process related to collateral management Section 4.4.

- Put on CSD Validation Hold all delivering settlement instructions from CSD participants on securities not subject to withholding tax at the time of transaction (MSA value 3);
- Put on CSD Validation Hold all settlement instructions from CSD participants on exempted pledge securities account (MSA value X2);

Note: this particular control on exempted pledge securities accounts is analysed in the context of the business process related to collateral management Section 4.4.4.

- “NBBE-RT02”, a negative CSD Validation Hold rule (Case 1 Restriction Type), will be implemented in order to bypass the validations defined in the positive rule:
 - Payment Free of Delivery (PFOD) Settlement instructions from CSD participants on non-exempt client securities accounts (MSA value N1) must not be put on CSD Validation Hold.

Cross-CSD Impact Analysis

Impact on Investor CSD account configuration

The concept of an exempt account (X-account) and a non-exempt account (N-account) also applies to Investor CSDs in NBB-SSS. The omnibus account of an Investor CSD would also be qualified as either exempt or non-exempt upon presentation of a tax certificate according to the tax status of the underlying participants in the Investor CSD.

Segregation will be required for Investor CSDs that have both categories of investors (exempted as well as non-exempted from Belgian withholding tax) as participants. Two different types of omnibus accounts will have to be opened in NBB-SSS, and, based on the tax status of the participant, the securities account(s) owned by the participant will be linked to either an exempted or non-exempted omnibus account of the Investor CSD at NBB-SSS. For business scenarios wherein the Investor CSD participants hold securities on behalf for their clients in omnibus accounts at Investor CSD, further level of

segregation may be required depending upon the tax status of the participant's clients, as illustrated in the example below:

Figure 18 - Relationship between the participant accounts at Investor CSD and omnibus accounts in Issuer CSD (split of participant account holdings due to different tax status of clients)

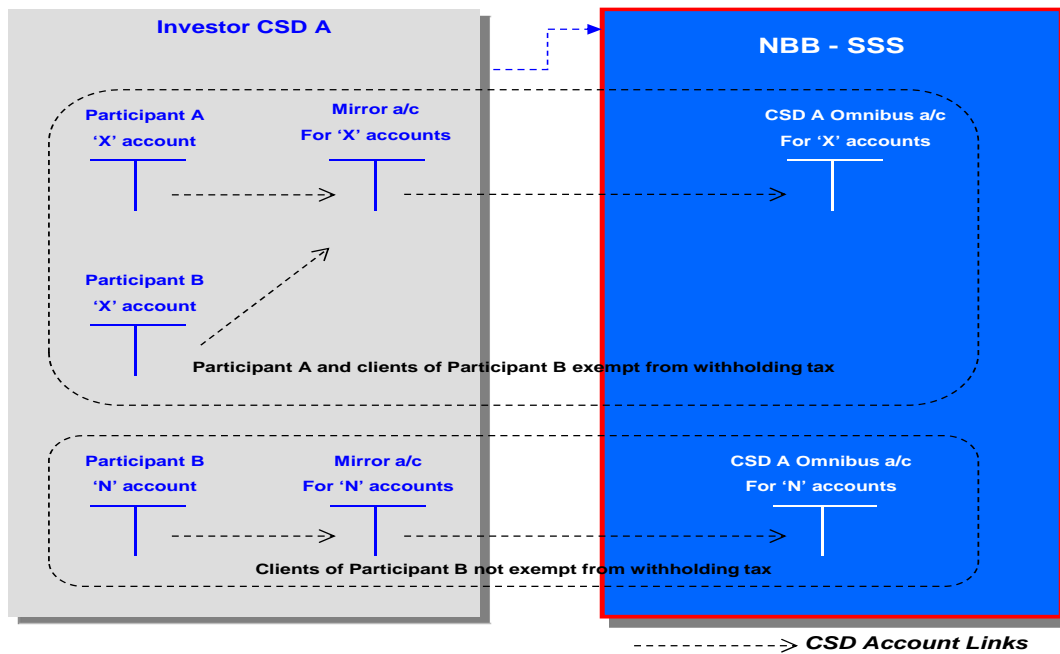

Impact on Investor CSD settlement flows

To ensure that the tax related validations are performed at the level of Business Instructions prior to their initial acceptance in T2S, Investor CSDs must implement the tax related rejection restriction rule defined by NBB-SSS.

Indeed, the restriction rule NBBE-RT01 rejects settlement instructions on non-exempt securities account when the security is exempt from withholding tax, or when specific ISO transaction codes related to collateral management operations are used:

- In case of a cross-CSD scenario between a participant of NBB-SSS whose Business Instruction is matching the rule parameters and a participant of an Investor CSD, the Business Instruction of the NBB-SSS' participant would be rejected and the Business Instruction at the Investor CSD level would remain unmatched.
- In other cross-CSD scenarios generating realignments at NBB-SSS (i.e. between Investor CSDs' participants or a participant of NBB-SSS and a participant of an Investor CSD), the rejection rule can be triggered on the realignment instructions, resulting in the Business Instructions being accepted, matched, then cancelled.

Investor CSDs having both exempt and non-exempt participants will have to open two different types of omnibus accounts and implement the restriction rule NBBE-RT01 defined by NBB-SSS. In addition, they will have to implement the MSA for securities accounts to categorise participant accounts as exempt or non-exempt as well as the MSA for securities to categorise securities issued by NBB-SSS as exempt or non-exempt.

The restriction rule NBBE-RT02 does not need to be implemented by Investor CSDs.

It is used by NBB-SSS for the calculation of withholding taxes. The restriction rule will potentially impact cross-CSD transactions, putting the Business Instruction of the NBB-SSS participant or a T2S Generated Realignment Instruction on CSD Validation Hold. This will result in the transaction being pending for settlement until NBB-SSS has performed the relevant checks and calculations; once done, the settlement instruction on hold will be released by NBB-SSS and the transaction will be eligible for settlement. Note that this restriction rule may prevent the use of such non-exempt securities as eligible for T2S auto-collateralisation.

Conclusion

Withholding tax calculation procedures will be supported by the use of restriction rules by NBB-SSS in its role as Issuer CSD. This may impact Investor CSDs' account structure and settlement flows depending on the tax status of their underlying participants. In the case where an Investor CSD would have participants which are exempt, and participants which are non-exempt from Belgian withholding tax:

- **The Investor CSD's account structure will require segregation of omnibus and participants according to the tax status of its participants;**
- **The Investor CSDs should implement the rejection restriction rule defined by NBB-SSS in its own environment in order to ensure that the tax related validations are performed at the level of Business Instructions, to avoid settlement scenarios where cancellation takes place after initial acceptance and matching. For this purpose, the Investor CSD is likely to implement the MSAs defined for tax status on account and securities level.**

Iberclear, in its role as Investor CSD of Monte Titoli, has defined a restriction rule to limit the scope of financial instruments available to omnibus account holders in order to manage disclosure

and reporting requirements to foreign tax authorities, and keep benefitting from a global tax exemption. This restriction stemming from a business decision would only affect Investor CSDs in case they use Iberclear as intermediary to access securities in Monte Titoli.

With a single CSD having defined restriction rules in the context of withholding tax, the XMAP does not currently identify potential for harmonisation of restriction rules used in T2S. It must be emphasised that tax information is not part of the standard set of static data and will require the use of MSAs.

4.4 Collateral Management

Introduction

For the assessment of restriction rules according to the methodology defined in Section 2.2 “Methodology to quantify impacts on Investor CSDs”, Collateral Management is categorised as an optional service from an Investor CSD’s standpoint, as it is not necessary for carrying out Investor CSD activity.

Collateral Management refers to the handling of all tasks related to the management of collateral (collateral valuation, reporting, processing of margin calls and returns, monitoring of collateral substitution, notification of corporate events, processing of securities transfers on behalf of the client, etc...) posted by a borrower, or collateral provider, to a lender, or collateral taker, to secure its obligations.

According to the ECB glossary, collateral management includes the process used to control the correspondence between the market value of the relevant collateral and the required value of that collateral. It generally also includes the generation and processing of collateral transfers.

The collateral provided by the borrower (i.e. collateral provider) serves as protection for a lender (i.e. collateral taker) against the borrower's default and can be provided as securities or cash. If the borrower defaults on his obligation, the borrower forfeits the assets pledged as collateral and the lender assumes the ownership of the collateral.

In the case of securities collateral, the assets can be provided either by transfer of full ownership (i.e. repo) from a collateral provider (borrower) to a collateral taker (lender) or by the transfer of possession from a collateral provider to a collateral taker under a security right (i.e. pledge, charge or lien), where the full ownership of the assets remains with the collateral provider.

Collateral management can be categorised as an ancillary service provided by CSDs and will continue to be offered upon migration to T2S. T2S as a settlement platform only facilitates the functions of collateral management; CSDs may use the functionalities available in T2S to offer their collateral management services, inter alia centralisation of collateral pools and liquidity, earmarking of collateral, or STP cross-CSD settlement. However, the necessary framework and controls for providing collateral management services are for a great part managed outside T2S.

The collateral taker defines the eligibility criteria of the collateral to be received, in order to mitigate the financial risk on the transaction. Securities collateral transfer could take place in the context of various transactions, inter alia:

- Pledge transactions between two parties
- Securities lending and borrowing
- Initial margin for CCP transactions

- Tri-party repo collateral services

Below is an example of current implementation of collateral mobilisation during a classic pledge transaction between two parties; the CSD only performs the function of settlement infrastructure and pledge account servicer, acting upon authorisation of the parties, but does not provide collateral management services such as collateral eligibility check or collateral valuation. The pledger is the party that provides the collateral and the pledgee is the party that accepts the collateral as a pledge. Participant A is the pledger pledging the securities from his securities account to the pledge account in favour of the pledgee. The pledgee could be participant B of CSD A or external to CSD A (non-participant C).

Figure 19 - Pledge service - Current model - sample

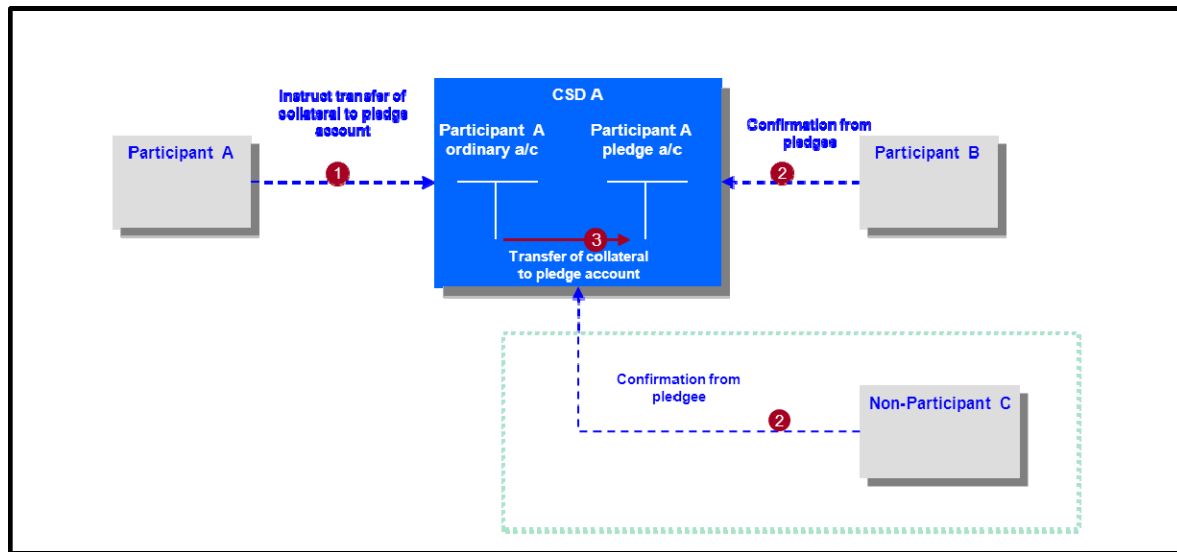

Based on the settlement instruction from the pledger (step 1), the CSD will proceed to the transfer of collateral to the pledge account (step 3) upon confirmation that the collateral is eligible for the pledge by the pledgee (step 2).

The instructions mobilising collateral can be identified using specific transaction codes in T2S, inter alia ISO transaction codes COLI and COLO, which can be used in the configuration of restriction rules. This enables the collateral mobilisation process to be distinguished from other processes.

The description of current services and controls, restriction rules and impact analysis by market is detailed in the next sections.

4.4.1 Baltic CSDs

Pre T2S – Process Controls

The Baltic CSDs (Estonia, Latvia, and Lithuania) provide their participants the possibilities to reserve securities positions in the context of bilateral pledge operations. The reservation of these securities positions is managed by the Baltic CSDs.

Adapted State – Process Controls

The Baltic CSDs plan to define the following restriction rules in the context of bilateral pledge operations:

Rejection (Case 1 Restriction Type):

BCDR05: a positive rejection rule to reject all settlement instructions sent by CSD participants debiting the “PLDG” sub-position.

The parameters configured in this rule are listed below:

- Debited Position/Balance, with value:
 - PLDG
- Party Type (of the instructing party), with value:
 - CSD Participant

Reservation (Case 3 Restriction Type):

PLDG: reservation of securities positions in the context of bilateral pledge operations.

Cross-CSD Impact Analysis

Impact on Investor CSD account configuration

The rule “BCDR05”, along with the position type “PLDG”, are defined for bilateral pledge operations in order to segregate the securities pledged into the “PLDG” position type, and to restrict access to this position. This segregation will be applicable to the Investor CSD omnibus account only upon request, and therefore it is assumed that in such case this segregation is also required as Issuer CSD.

Impact on Investor CSD settlement flows

The rule “BCDR05”, along with the position type “PLDG”, will not impact trade-related cross-CSD transactions since only the securities in the available position (“AWAS” Position Type) will be used by T2S generated Realignment Settlement Instructions. It is only in the case of a cross-CSD transaction where a participant of the Baltic CSDs tries to deliver from the reserved position to a participant of another CSD that the rule would be triggered. It would also be the case if an Investor CSD would try to debit directly the reserved position in the omnibus account (this should not happen in normal business scenarios). Since this segregation is only applicable to the Investor CSD omnibus account upon request, it is assumed that in such case this segregation is also applicable as Issuer CSD.

4.4.2 BOGS

Pre T2S – Process Controls

In BOGS, some securities have been issued for a specific purpose: certain Greek banks which are participants of BOGS are only allowed to use them for liquidity purposes, i.e. using repos, buy sell backs, and collateral operations. In order to monitor the activity on these securities, the relevant banks are requested to hold them on the specific security account category ‘502’ from where they can only be moved using specific operation types. However, this rule applies for the banks having received these

securities on issuance: if these securities are moved from the securities account of category '502' to another participant via a repo or buy sell back operation, then the latter may execute all the possible operation types. Some exceptions are possible and this is the reason why instructions referring to other operation types are not directly rejected, but put on hold in order to be verified by BOGS.

Adapted State – Process Controls

BOGS has defined the following restriction rules (Case 1 Restriction Type) in order to implement the required controls related to the above process in T2S:

- “RT01”, a negative CSD Validation Hold rule, will be implemented to bypass the validations defined in the restriction rule “RT02”, if specific ISO transaction codes are used in the settlement instructions: REPU, RVPO, COLI, COLO, BSBK, SBBK.
- “RT02”, a positive CSD Validation Hold rule, will be defined to put settlement instructions from CSD participants acting as DCPs on special security account category '502' on CSD Validation Hold. More specifically, the delivering party will be checked in case of deliveries, and the receiving party in case of receiving (RECE) settlement instructions. This restriction rule defines the scope of settlement instructions to be affected by the rule, the exceptions being defined in the above negative rule (RT01).

The parameters used in the context of these rules are:

- ‘SecAccountCategory’, an MSA on account level, with specific value ‘502’
- ‘PartyFlag’, an MSA on party level, with values ‘DCP and ‘ICP’ (and parameter debit and credit)
- Securities Movement Type: DELI, RECE

Cross-CSD Impact Analysis

Impact on Investor CSD account configuration

The restriction rules of BOGS impact only the security accounts of category '502'. These accounts are applicable only for domestic participants. Therefore, no impact is foreseen on Investor CSD account configuration.

Impact on Investor CSD settlement flows

The specific service put in place in BOGS is only offered to domestic participants (some Greek banks). The restriction rules have been implemented accordingly and do not need to be implemented by Investor CSDs. As the restriction rules use an MSA ‘Party Type’ with value ‘DCP’, as well as another one to define a specific securities account category (502), the use of these MSAs ensure that settlement instructions from Investor CSDs are not impacted, as the omnibus accounts of Investor CSDs will not be of category '502'. It would only be in the case of a cross-CSD transaction between a DCP of BOGS and a participant of an Investor CSD where the BOGS participant would erroneously use the account category '502' without the allowed ISO transaction codes that the transaction would be pending for settlement.

4.4.3 Clearstream Banking Frankfurt (CBF)

Pre T2S – Process Controls

Clearing Members of Eurex Clearing can currently choose to open pledged securities accounts either at Clearstream Banking Frankfurt (CBF), SIX Securities Services, or Clearstream Banking Luxembourg (CBL) for the purpose of providing collateral to the CCP. These securities accounts are maintained on a Clearing Member's behalf with the securities pledged to Eurex Clearing. The Clearing Member debits the securities directly within the system of the relevant CSD to the relevant pledged account.

In this context, specific instruction types are used for collateral transfers in CBF.

Pledge securities accounts are not available to Investor CSDs of CBF, as per the requirements that Clearing Members need to hold such accounts directly with CBF, CBL, or SIX-SIS (Eurex Clearing Conditions).

Adapted State – Process Controls

CBF has defined the below restriction rules for movement of securities on Eurex collateral accounts held in CBF:

- “Party and account configuration – REJECT”– Case 1 Restriction Type: Positive Rejection
T2S should reject delivering settlement instructions from CSD participants debiting securities out of Eurex Collateral Accounts.
- “Party and account configuration – REJECT”– Case 1 Restriction Type: Negative Rejection
This rule defines the exception to the previous restriction, so that CBF and Eurex Clearing AG (ECAG) are allowed to instruct already matched free of payment deliveries debiting Eurex collateral accounts.
- “Party and account configuration – CVAL”– Case 1 Restriction Type: Positive CSD validation hold
T2S should put on CSD Validation Hold all receiving settlement instructions from CSD participants crediting securities into Eurex collateral accounts in order to perform additional validations on the securities to be pledged as collateral.

An MSA on account level ‘Konto-Art’ is used in the above rules to identify the specific collateral accounts that are impacted by the rules. There are no specific values provided currently for the MSA. But the values reflect the internal account types used in CBF.

The parameters configured in the rules are listed below:

- Konto Art (MSA) with alphanumeric values reflecting CBF internal account types in T2S, in order to distinguish Eurex Collateral Accounts
- Party type of the Instructing Party, with the value:
 - ‘CSD participant’, ‘External CSD’

- Instructing Party, with the BIC values of CBF and ECAG
- Payment type code, with the value:
 - 'FREE': free of payment
- Matching status, with the value:
 - 'MACH': already matched settlement instructions
- Securities Movement Type, with the values:
 - 'RECE'
 - 'DELI'

Cross-CSD Impact Analysis

Impact on Investor CSD account configuration

Eurex Collateral Accounts are opened to allow Clearing Members of Eurex Clearing to deposit collateral and fulfil margin requirements resulting e.g. from Clearing activity. Such accounts are not available to Investor CSDs as per current market practices.

Impact on Investor CSD settlement flows

The controls put in place by CBF result from collateral obligations of Clearing Members towards Eurex Clearing for trading activity, and should not be replicated by Investor CSDs.

Investor CSDs' settlement flows would only be impacted in the case of a cross-CSD transaction delivering securities into a Eurex Collateral Account: the transaction would be pending for settlement, as the instruction entered by the Eurex participant is put on "CSD Validation Hold".

4.4.4 ESES (Euroclear Belgium, Euroclear France, Euroclear Netherlands)

Pre T2S – Process Controls

In the legacy platform of ESES, segregation of securities positions is based on two levels of securities sub-positions within securities accounts:

- The account Nature, which refers to business / legal purpose of the position (eg. Registered, bearer, specific CA purpose)
- The Collateral Indicator (ICPG), which segregates securities eligible as collateral

A specific service is put in place for reporting purposes: clients' assets segregated as collateral (i.e. collateral pool) are temporarily transferred back to the main account at the end of the day while end-of-day reporting, i.e. statement of holdings is being generated. The reverse transfer is performed shortly after for the start of the new business day. The background of this service is a legal requirement to which some clients of ESES have to comply.

Adapted State – Process Controls

In T2S, ESES will adapt its segregation model from a model based on two levels of securities sub-positions in its legacy platform to a model based on segregation at one level of securities sub-positions in T2S:

- The first level (Account nature) is mapped at the level of securities accounts, i.e. each Account Nature will be represented in T2S by a separate account
- The second level (collateral indicator) is mapped with the T2S sub-positions (Case 3 Restriction Type).

ESES will allow the credit and debit of T2S securities sub-positions to indicate whether securities are eligible as collateral (e.g. transfer from 'AWAS' to 'EXXX') using already matched instructions. In order to be able to transfer securities earmarked as collateral (EXXX) back to the main deliverable position (AWAS) for the reporting purpose mentioned here above, the following restriction rule has been put in place:

Blocking (Case 2 Restriction Type)

RT08 (ESE-043-COL): this restriction rule blocks settlement instructions on specific securities account debiting or crediting the 'EXXX' position type. For customers subscribing to this specific service, this intraday restriction will be activated 30 minutes before the FOP cut-off (i.e. 17:30) to freeze the earmarked positions so that ESES can initiate the transfer back to the deliverable ('AWAS') position and generate the end of day reporting. The reverse transfer will be initiated at the start of the new business day in T2S.

The parameters configured in the rules are listed below:

- Debited/Credited position:
 - 'EXXX'

Cross-CSD Impact Analysis

Impact on Investor CSD account configuration

No impact on Investor CSDs' account configuration has been identified as the positions which are subject to blocking or rejection are created by the T2S operator.

Impact on Investor CSD settlement flows

The restriction rule defined by ESES does not need to be implemented by Investor CSDs and will not impact cross-CSD settlement flows: RT08 (ESE-043-COL), the rule only prevents, shortly before the FOP cut-off, the earmarking and unblocking of securities positions that ESES participants use for the auto-collateralisation process. As such, it will not impact regular cross-CSD transactions and would only impact cross-CSD settlement transactions in the case of a (FOP) cross-CSD delivery from an ESES participant to a participant of an Investor CSD, where the participant of ESES would deliver directly from the 'EXXX' position type. The transaction would be temporarily blocked while the intraday restriction is active, and would be submitted to settlement on the next business day.

4.4.5 Interbolsa

Pre T2S – Process Controls

Interbolsa offers its participants the possibility to pledge securities in favour of third-parties. More specifically, special transfer instructions are used by Interbolsa’s participants in order to, e.g. transfer collateral to Banco de Portugal in the context of credit operations. Currently the following “situations” (position types) are being used to segregate the pledged collateral. Collateral management services such as collateral eligibility check and valuation are not performed by Interbolsa.

Table 12 - Situations (position types) at Interbolsa

Situation of securities	Use
003	Blocked for pledge
004	Blocked for guarantee
024	Blocked for SII (Investor Compensation Scheme) pledge
027	Blocked for FGD (Deposit guarantee fund) pledge

The pledged “situations” (i.e. position types) “003” and “004” will be used in the context of bilateral pledge operations, while the position types “024”, and “027” are used in the Portuguese market for specific collateral takers, namely the Investor Compensation Scheme (024) managed by the Portuguese regulator, CMVM, and the Deposit Guaranty Fund (027) operated by the central bank, Banco de Portugal. These functions are available only for participants of the Portuguese market.

Adapted State – Process Controls

Interbolsa has defined the below restrictions types and rule in order to implement controls for the pledge services it provides to its participants. The CSD plans to use specific position types to implement the pledge services, corresponding to the situations currently existing in the CSD. Compared to the “situations” of Interbolsa, a new position type “BL25” will be defined in T2S, for when the collateral is in the process of being realised by the Investor Compensation Scheme managed by the Portuguese regulator.

- BL03 – Case 3 Restriction Type
Creation of the “Blocked for pledge” position type
- BL04 – Case 3 Restriction Type
Creation of the “Blocked for guarantee” position type
- BL24 – Case 3 Restriction Type
Creation of the “Blocked for SII (Investor Compensation Scheme) pledge” position type
- BL25 – Case 3 Restriction Type
Creation of the “Execution of Pledge” (Investor Compensation System) position type
- BL27 – Case 3 Restriction Type

Creation of the “Blocked for FGD (Deposit guarantee fund) pledge” position type

- SR03 – Case 1 Restriction Type : Positive rejection rule

T2S should reject all settlement instructions sent by CSD participants debiting the securities positions that are blocked for pledge or guarantee. In the case of BL03 and BL04, participants can transfer (i.e. debit and credit) securities positions thanks to settlement restrictions, while in the case of BL24/25 and BL27, respectively CMVM and Banco de Portugal can unblock the positions.

Table 13 - Position Types of Interbolsa in T2S

Position type in T2S	Description
BL03	Blocked for pledge
BL04	Blocked for guarantee
BL24	Blocked for SII (Investor Compensation Scheme) pledge
BL25	Execution of Pledge (Investor Compensation System)
BL27	Blocked for FGD (Deposit guarantee fund) pledge

The parameters configured in the rules are listed below:

- Party type of the Instructing Party, with the value:
 - ‘CSD participant’
- Debited/Credited position, with the values:
 - ‘BL03’, ‘BL04’, ‘BL24’, ‘BL25’, ‘BL27’

The usage of the pledged positions will be aligned to the practice pre-T2S with “situations” (see description of the *Pre T2S – Process Controls*).

- SR04 – Case 1 Restriction Type : Positive rejection rule

T2S should reject all settlement restrictions sent by CSD participants debiting or crediting the securities positions that are blocked for pledge or guarantee.

The parameters configured in the rules are listed below:

- Party type of the Instructing Party, with the value:
 - ‘CSD participant’
- Debited/Credited position, with the values:
 - ‘BL24’, ‘BL25’, ‘BL27’

Cross-CSD Impact Analysis

Impact on Investor CSD account configuration

The securities positions available for pledging at Interbolsa are either not available to Investor CSDs, in the case of the Investor Compensation Scheme “BL24” or “BL25” and Deposit Guarantee Fund “BL27”, or the segregation at the level of omnibus account is not necessary and could be done directly at the level of the CSD participant, in the case of “BL03” and “BL04” which are used in the context of bilateral pledge operations. In such case, it is up to the Investor CSD to decide between segregation by sub-positions within an account and separate accounts, and how to restrict access to these positions. It is important to stress that such segregation would never be imposed by Interbolsa, but would simply result from the service offering of the Investor CSD to its participants.

Impact on Investor CSD settlement flows

In the case where Investor CSDs’ participants would require segregation securities positions in the context of bilateral pledge operations (“BL03” and “BL04”), the Investor CSD needs to implement segregation either by sub-positions within an account, or with separate accounts. In the latter case, the access to these positions can be managed by access rights instead of restriction rules: the implementation of a restriction rule will depend on the choice of the Investor CSD.

The impact of the restriction rule on regular cross-CSD transactions will be strongly mitigated.

Indeed, while cross-CSD transactions delivering into a pledge account would be common, as pledge accounts are standard custody accounts in which pledged positions are segregated (if the participant of Interbolsa uses the pledge account as receiving account in a trade-related transaction), the result of a trade transaction can only be a credit of the available positions (AWAS position type) of the pledge account, and will not be affected by the rule defined by Interbolsa.

Furthermore, the restriction rule has been defined accordingly to reject any settlement instructions debiting (or in some cases crediting) the blocked position type unless instructed by the CSD. This is illustrated in the example below:

Figure 20 - Cross-CSD mobilisation of collateral between a participant of Interbolsa and a participant of an Investor CSD

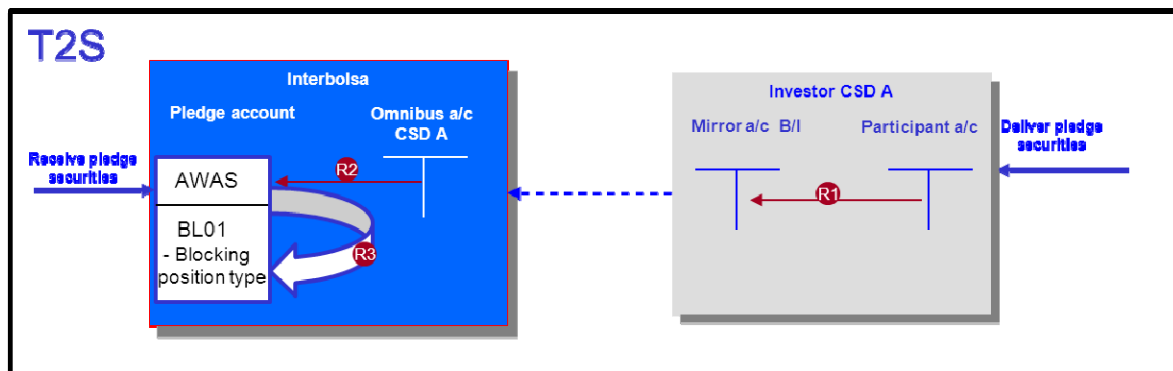

Scenario: In this scenario, the Investor CSD participant is either also a participant of Interbolsa for the purpose of opening accounts used for pledge services (pledger), or simply the trade counterparty from the participant of Interbolsa which has decided to pledge securities resulting from the trade.

The cross-CSD transaction will credit the available position type (AWAS) in the pledge account of Interbolsa's participant (R1 & R2).

In a second step, upon successful settlement of this transaction, the pledger instructs the opening of the pledge transaction to Interbolsa outside T2S. The CSD then instructs the movement of the pledge securities into the blocked pledge position type (R3) using intra-position movement instructions (settlement restrictions).

Findings: Neither the Business Instructions from the Investor CSD participant nor the Business Instruction from the pledger are impacted by the restriction rules setup by Interbolsa. The restriction rules only prevent the opening of the pledge which is a separate operation executed by the CSD.

It would only be in the case of a cross-CSD delivery from a participant of Interbolsa using one of the blocked position types, that the transaction would be impacted: the Business Instruction of Interbolsa's participant will be rejected and the Business Instruction at the Investor CSD level will remain unmatched.

4.4.6 KELER

Pre T2S – Process Controls

KELER provides its participants the possibilities to block securities positions in the context of pledge operations (be it bilateral or multilateral) as well as Repos. The blocking and unblocking of these securities positions is managed by KELER.

Adapted State – Process Controls

KELER partly relies on segregation by securities sub-positions in T2S. In the context of pledge and Repo operations, some of those securities sub-positions will be exclusively managed by KELER, i.e. not available to CSD participants. In order to achieve the required level of control and handle the process, KELER has created the following restriction rules and restriction types:

- RT09 Restricted Balance

Two positive Case 1 Restriction Type rules, in order to reject settlement instructions and settlement restrictions debiting the position types described below.

- BL01

A Case 3 Restriction Type, created for unilateral and joint blocking of securities positions

- BL02

A Case 3 Restriction Type, created for bi- and trilateral blocking of securities positions

- BL03

A Case 3 Restriction Type, created for generic collateral blocking of securities positions

- BL04

A Case 3 Restriction Type, created for hold-in repo blocking of securities positions

The parameters configured in the rules are listed below:

- Party type of the Instructing Party, with the value:
 - 'CSD participant'
- Debited position, with the values:
 - 'BL01', 'BL02', 'BL03', 'BL04'

Cross-CSD Impact Analysis

Impact on Investor CSD account configuration

The securities positions 'BL01', 'BL02', 'BL03', 'BL04' created in the context of pledge and repo operations at KELER do not necessarily require segregation at the level of omnibus account, as the securities positions could just be restricted at the level of the CSD participant. In such case, it is up to the Investor CSD to decide between segregation by sub-positions within an account and separate accounts, and how to restrict access to these positions. It is important to stress that such segregation would not be imposed by KELER, but would simply result from the service offering of the Investor CSD to its participants.

Impact on Investor CSD settlement flows

The restriction rule "RT09_Restricted_Balance" defined at the level of settlement instructions will not have a direct impact on trade-related cross-CSD instructions, as realignment instructions would not make use of the restricted positions; i.e. realignment instructions would not match the restriction rules. As mentioned above, Investor CSDs offering such service could decide between segregation by sub-positions within an account and implement restriction rules similar to KELER, or segregation by separate accounts in which case privileges can be used.

It would only be in the case of a cross-CSD transaction between a participant of KELER debiting one of the blocked position types and an Investor CSD's participant, that the rule would be triggered: the Business Instruction of KELER's participant will be rejected and the Business Instruction at the Investor CSD level will remain unmatched.

The restriction rule "RT09_Restricted_Balance" defined at the level of settlement restrictions will not impact Investor CSDs' settlement flows, except if an Investor CSD would instruct an intra-position movement directly on its omnibus account to debit one of the blocked position types 'BL01', 'BL02', 'BL03', 'BL04'. As described earlier, segregation on the omnibus account of Investor CSDs has not been identified as necessary in this process. However, Investor CSDs offering this service may consider implementing the rule depending on their segregation model (i.e. by position types).

4.4.7 Monte Titoli

Pre T2S – Process Controls

Monte Titoli provides collateral management services to its participants through its triparty collateral management platform X-COM. The services include automated management of securities collateral for refinancing operations to the Central Bank, for Repo transactions, as well as for guarantee to the Central Counterparty (CC&G) as a result of trading activity.

Positions related to securities collateral chosen by X-COM are blocked in a specific position for a short lapse of time in order to perform settlement according to an “all or none” principle. If settlement is successful, the securities mobilised as collateral are transferred to the collateral taker. If on the other hand, settlement cannot be performed successfully, segregated positions are unblocked so that the securities can be used again for trade-related transactions.

Adapted State – Process Controls

Monte Titoli has defined restriction rules related to the collateral management services offered through X-COM. In line with the process before T2S, such controls aim at temporarily restricting securities positions selected by the triparty collateral management engine in a specific position type, then to attempt settlement of these securities for delivery to the collateral taker. If settlement cannot be performed, securities positions are unblocked, i.e. transferred back to the available “AWAS” position type. The following restriction rules and restriction types are created for this purpose:

- “RXCI”, a positive rejection (Case 1 Restriction Type) rule. The rule will be defined to reject settlement instructions on securities positions “BXCM” unless instructed by Monte Titoli (with the CSD as Instructing Party). The blocked securities positions are created with a Restriction Type 3. No MSA is needed for this rule.
- “RXCR”, a positive rejection (Case 1 Restriction Type) rule. The rule will be defined to reject settlement restrictions on blocked securities positions “BXCM” unless instructed by Monte Titoli (with the CSD as Instructing Party). The blocked securities positions are created with a Case 3 Restriction Type. No MSA is needed for this rule.
- “BXCM”, a Case 3 Restriction Type defined on securities positions. The restriction will be defined to temporarily block securities position in the context of collateral operations mobilised through X-COM. Debit and credit of such positions can only be instructed through interfacing with the application.

Cross-CSD Impact Analysis

Impact on Investor CSD account configuration

Participants willing to use the triparty collateral management services provided by Monte Titoli need to allow temporary segregation of some securities positions used by X-COM into the “BXCM” position

type, for collateral to be settled on an “all or none” basis. As securities positions are only restricted for a short lapse of time until settlement is performed, this temporary segregation is transparent for the participant.

Investor CSDs willing to use X-COM services will need to allow securities positions to be temporarily restricted by X-COM within a specific position type “BXCM” until settlement of the transaction is attempted. However, for the reasons mentioned here above, such temporary segregation does not need to be reflected in their books.

Nevertheless, as X-COM works STP for the selection and mobilisation of collateral based on available securities positions on a predefined “source” account, it is highly advisable and recommended by Monte Titoli that Investor CSDs open dedicated accounts for collateral operations managed through X-COM. This will allow segregation of eligible securities collateral available for transactions through X-COM from securities positions available for trade-related transactions. If dedicated accounts are not opened, any eligible securities positions available on the omnibus account could be selected for collateral transactions, which could lead to settlement fails for regular trade-transactions (due to lack of securities on the omnibus account versus positions available in participants’ accounts at the Investor CSD). This segregation should also be reflected in the Investor CSD’s account structure, e.g. with a one-to-one relationship between dedicated “collateral” accounts in Monte Titoli and at the Investor CSD.

Investor CSDs also need to reflect settlement of securities collateral mobilised through X-COM in their books, i.e. by debiting the appropriate participant’s account. As this is a manual process, securities positions at the Investor CSD and at Monte Titoli will be desynchronised until this adjustment is performed.

Impact on Investor CSD settlement flows

Monte Titoli’s restriction rules related to triparty collateral management will not have a direct impact on trade-related cross-CSD instructions, as realignment instructions would not make use of the restricted positions; i.e. realignment instructions would not match the restriction rules. Such restriction rules do not need to be implemented by Investor CSDs.

However, Investor CSDs willing to make use of the collateral management services proposed by Monte Titoli are strongly advised to open dedicated accounts for participation in the X-COM services to avoid side-effects on settlement: this will ensure that only securities collateral belonging to the participant using the service is mobilised by the collateral management system, and therefore eliminate the risk of settlement fails for trade transactions of other participants due to positions on omnibus accounts being debited as a result of the collateral mobilisation.

Regardless of whether a dedicated account is chosen for participation in the X-COM service, Investor CSDs will need to manually realign positions in their books based on settlement of collateral transactions mobilised through X-COM.

4.4.8 NBB-SSS

Pre T2S – Process Controls

Participants of NBB-SSS wishing to use the pledge services offered by NBB-SSS need to open and use a specific type of securities accounts:

- Account type 51 - pledge account – Used for pledge transactions outside NBB-SSS

A participant may pledge securities that he holds on his own securities or trading account by transferring them to the '51 account type' opened in his name.

Securities pledged shall not be released from the pledge account except in case of:

- Pledge substitution
- Increase/reduction in the amount pledged
- Total release of the pledge due to closure of the underlying transaction
- Realisation of the pledge by the pledgee

For any of the changes above, the pledgee must provide his consent to the CSD.

Pledge instructions use COLI and COLO ISO transaction codes that differentiate these instructions from settlement instructions used in other business areas.

Adapted State – Process Controls

NBB-SSS has defined the below restriction rule to implemented controls related to the pledge services it offers:

- “NBBE-RT02”, a positive CSD Validation Hold rule (Case 1 Restriction Type), will be implemented in order to:
 - Put on CSD Validation Hold all settlement instructions from CSD participants on non-exempt pledge securities accounts (MSA value N2);
 - Put on CSD Validation Hold all settlement instructions from CSD participants on exempted pledge securities account (MSA value X2)

Note: only the relevant part of the restriction rule NBBE-RT02, related to pledge securities accounts, is analysed in the context of this business process.

The MSA at account level “Account WT Type”, also used in the context of taxation, identifies the pledge accounts to which the rules should apply (MSA value N2/X2). Please refer to section 4.3.1 on Taxation for the full description of the MSA. The parameter “Instructing Party Type” is used with the value “CSD Participant” to identify settlement instructions sent by participants of NBB-SSS.

Cross-CSD Impact Analysis

Impact on Investor CSD account configuration

Participants willing to use the pledge service provided by NBB-SSS must open a securities account dedicated for holding securities pledged as collateral. Such accounts are identified with the use of MSAs. The service is available to Investor CSDs, which may open pledge accounts on behalf of their participants. Investor CSDs using this service must segregate their participants' holdings, in order to distinguish between pledged and available positions, and are likely to implement NBB-SSS' MSA on account level. Segregation by separate accounts is in this case advisable to benefit from the cross-CSD STP functionality of T2S; segregation by position types is also possible but not recommended as it would require a 2-step process for the settlement in a pledge account, the Investor CSD instructing directly NBB-SSS with the pledge instruction and, upon successful settlement, transferring the securities to its participants' pledge positions.

Impact on Investor CSD settlement flows

While Investor CSDs using the pledge services of NBB-SSS will need to ensure the pledged positions are segregated from securities available for other purposes, NBB-SSS' restriction rules do not need to be replicated by Investor CSDs. In the case of segregation into separate accounts, a pledge transaction involving an Investor CSD will be materialised by an intra-CSD transfer from the participant's regular account to the participant's pledge account. As these accounts will be mapped to different omnibus accounts at NBB-SSS, the restriction rule will be triggered on the realignment instructions being generated: NBB-SSS will only release the transaction once the authorisation has been provided by the pledgee. In the case of segregation by position types, settlement at NBB-SSS and the Investor CSD will in any case be asynchronous.

4.4.9 OeKB CSD

Pre T2S – Process Controls

OeKB CSD's operational model relies on the usage of standard participant accounts and special blocked securities accounts. For blocked securities accounts, the securities account owner may only debit/credit the positions with third party authorisation verified by OeKB CSD.

Blocked accounts are used for several purposes in the context of collateral management, among others:

- Pledging of collateral for intraday overdraft facilities (Sub 90),
- Pledging of Collateral for other reasons (e.g. CCP collateral, collateral for EIB)

At present, the collateral management services offered through blocked accounts are only used by domestic participants of OeKB CSD.

Adapted State – Process Controls

OeKB CSD has defined the below restriction rules in order to control the debit/credit on such blocked accounts:

- “R-2” – Case 1 Restriction Type: positive/negative CSD Validation hold

T2S should put on CSD validation hold all receiving settlement instructions from the participants on accounts designated as ‘Receives blocked’ (identified with MSA), unless instructed by OeKB CSD.

The rationale is that the securities transferred on this type of account have to be validated as eligible collateral by OeKB CSD.

- “R-3” – Case 1 Restriction Type: positive/negative CSD Validation hold

T2S should put on CSD validation hold all delivering settlement instructions from the participants on accounts designated as ‘Deliveries blocked’ (identified with MSA), unless instructed by OeKB CSD.

The rationale is that release of securities collateral from this type of account has to be checked by OeKB CSD.

- “R-4” – Case 1 Restriction Type : positive/negative CSD Validation hold

T2S should put on CSD validation hold all instructions from the participants on accounts designated as ‘Deliveries and received blocked’ (identified with MSA), unless instructed by OeKB CSD.

The transactions on this account type need to be checked for both collateral mobilisation and release.

The MSA “Account Category” is used in the restriction rules to identify the specific securities accounts to which the rules would apply. The parameters configured in the rules are listed below:

- “Account Category”, an MSA on account level, with the following (non-exhaustive list of values):
 - Receives blocked
 - Deliveries blocked
 - Deliveries and Receives blocked
- Instructing Party:
 - OeKB CSD’s BIC
- Security Movement Type:
 - RECE (receiving settlement instructions)
 - DELI (delivering settlement instructions)

Cross-CSD Impact Analysis

Impact on Investor CSD account configuration

OeKB CSD offers collateral management services using segregated pledge accounts. These accounts are categorised as either “Receives blocked”, “Deliveries blocked”, or “Deliveries and Receives blocked” and restrictions prevent CSD participants to credit or debit these accounts without OeKB CSD’s validation checks.

Such accounts are identified with the use of MSAs. The service, while mostly used by local participants, is available to Investor CSDs, which may open pledge accounts on behalf of their participants. Investor CSDs using this service should then segregate their participants’ holdings, in order to distinguish between

pledged and available positions, and consider implementing OeKB CSD's MSA on account level. Segregation by separate accounts is in this case advisable to benefit from the cross-CSD STP functionality of T2S; segregation by position types is also possible but would require a 2-step process for the settlement in a pledge account, the Investor CSD instructing directly OeKB CSD with the pledge instruction and, upon successful settlement, transferring the securities to its participants' pledge positions.

Impact on Investor CSD settlement flows

While Investor CSDs using the pledge services of OeKB CSD will need to ensure the pledged positions are segregated from securities available for other purposes, OeKB CSD's restriction rules do not need to be replicated by Investor CSDs. In the case of segregation into separate accounts, a pledge transaction involving an Investor CSD will be materialised by an intra-CSD transfer from the participant's regular account to the participant's pledge account. As these accounts will be mapped to different omnibus accounts at OeKB CSD, the restriction rule will be triggered on the realignment instructions being generated and the transaction will be released by OeKB CSD upon the successful relevant collateral checks (eligibility of release of collateral). If the collateral transfer is not valid, cancellation will need to be performed by the Investor CSD (owner of both Business Instructions). In the case of segregation by position types by the Investor CSD, settlement at OeKB CSD and the Investor CSD will in any case be desynchronised.

Conclusion

Restriction rules are defined by CSDs to support different services they provide in the context of collateral management. The need for Investor CSDs to implement segregation or restriction rules in their own structure (i.e. data scope) depends on the availability of the service to Investor CSDs.

The Baltic CSDs have defined a restriction rule, along with a position type, in order to support bilateral pledge operations. Pledged securities will be segregated in a specific position type and access to this sub-position will be restricted. This segregation will only be applicable to the Investor CSD omnibus account upon request, and therefore it is assumed that in this case this segregation is also applicable as Issuer CSD.

In the case of NBB-SSS, the service will be available to Investor CSDs opening a pledge account on behalf of their participants. Investor CSDs using this service will need segregate their participants' securities positions to distinguish pledged positions from those available for other purposes, and map them to separate omnibus accounts at NBB-SSS. Replication of the restriction rules is not required, as pledge transactions involving Investor CSDs (as in the case of any other domestic participant) will be pending until released by NBB-SSS.

In the case of Interbolsa, restriction rules have been defined to control the pledge services offered to participants for collateral transactions with third-parties. The pledge services will rely on the mechanism of segregation by position types for blocking the pledged positions. These rules do not need to be implemented by Investor CSDs, as the pledged positions are either only relevant to

domestic participants, e.g. pledge in favour of Banco de Portugal, or used in the context of bilateral operations, in which case no segregation is required at the level of omnibus accounts, but only at the level of participants' accounts. Furthermore, in the case of cross-CSD mobilisation of collateral where securities from a trade would be used for pledging by Interbolsa's participant, the transaction would not be affected: the restriction rule controls the pledge itself, which is a separate operation executed by the CSD.

KELER has defined restriction rules to control the pledge of securities in various business scenarios. Pledged/blocked positions will be segregated in various position types and can only be debited by the CSD. These rules related to this optional service do not necessarily need to be implemented by Investor CSDs, as the pledged positions could also just be restricted at the level of the Investor CSD's participant account.

Monte Titoli has defined restriction rules in the context of triparty collateral management services. The services will rely on the mechanism of segregation by position types in order to ensure settlement of a collateral instruction on an "all or none" basis. Investor CSDs willing to make use of these services do not need to implement the related restriction rules but are advised to open dedicated accounts for participation in the X-COM services: this will ensure that only securities collateral belonging to the participant using the service is mobilised by the collateral management system, and therefore eliminate the risk of settlement fails for trade transactions of other participants due to positions on omnibus accounts being debited as a result of the collateral mobilisation. This segregation should also be reflected in the Investor CSD's account structure, e.g. with a one-to-one relationship between dedicated "collateral" accounts in Monte Titoli and at the Investor CSD. In their books, Investor CSDs also need to reflect the settlement of securities collateral mobilised through X-COM in their books, i.e. by debiting the appropriate participant's account.

In the case of OeKB CSD, restriction rules have been defined to support the collateral management services offered to participants for transactions with third-parties. The services rely on the usage of pledge accounts on which collateral positions are restricted, and will be available to Investor CSDs opening a pledge account on behalf of their participants. Investor CSDs using these services will need to segregate their participants' securities positions to distinguish pledged positions from those available for other purposes, and map them to separate omnibus accounts at NBB-SSS. Replication of the restriction rules is however not required.

Clearstream has defined restriction rules to support the activity of Eurex Clearing as Central Counterparty, more precisely to control provision and withdrawal of collateral on dedicated Eurex Collateral Accounts. Such accounts will not be available to Investor CSDs according to current market practices: this limits the potential impacts on settlement flows. In a scenario of cross-CSD mobilisation of collateral where securities from a trade would be received directly on the pledge account of the CBF participant, the transaction would be put on hold until additional collateral eligibility check is performed by the CSD.

In ESES, restriction rules have been defined in the context of the auto-collateralisation process for the securities positions created for the earmarking of collateral, and will de facto not impact Investor CSDs.

Finally, in BOGS, restriction rules have been put in place to control the usage of some securities which can only be used for liquidity purposes by certain participants of the CSD. This control is only applicable to domestic participants, and the restriction rules are configured to exclude any impact on Investor CSDs' settlement flows.

4.5 Insolvency Procedures

Note: The CSG's task force on insolvency proceedings aimed at defining common procedures to be applied in case of insolvency of a participant, and has raised a number of Change Requests to ease the operational handling in case of an insolvency scenario. After implementation of CR558 in November 2016, a new restriction type that alleviates the need to define restriction rules and MSAs in the context of insolvency has been defined, and the XMAP will check with CSDs the need to define other restriction rules and MSAs in this context.

Introduction

For the assessment of restriction rules according to the methodology defined in Section 2.2 "Methodology to quantify impacts on Investor CSDs", Insolvency Procedures are categorised as a necessary business process from an Investor CSD's standpoint. Indeed, Investor CSDs must comply with the processes put in place in the case of insolvency by the Issuer CSD.

In the context of this paper, "Insolvency procedures" refer to the controls based on restriction rules implemented by CSDs in order to deal with the scenario of insolvency of a participant⁸¹.

A CSD or NCB may have to block all or part of the activity of a client because of, among other reasons, insolvency, bankruptcy proceedings, liquidation proceedings, suspicion of money laundering or clients not meeting their contractual obligations with the CSD. In many cases, blocking of the activity of a client is performed after a court order has been enforced against the client.

T2S provides CSDs and NCBs with an extensive toolkit to implement controls in case of suspension/insolvency of a client declared by the competent authorities. This can be achieved either:

- At the level of business validation, through the use of Case 1 Restriction Types to reject or put on "CSD Validation Hold" instructions non-compliant with regulations or sent by suspended clients,
- At the level of settlement eligibility, through the use of Case 2 Restriction Types to prevent settlement (i.e. intra-day restrictions on parties, accounts or securities). Case 3 Restriction Types may be also used in those cases in which specific securities positions or cash balances have to be blocked.

It is important to note that in some cases CSDs and NCBs will use a combination of different restriction cases in T2S.

For illustration purposes, upon reception by the CSD of a court order enforced against a client that has to be applied with immediate effect, a CSD might be requested to:

- Block the activity of the suspended client using an intra-day restriction (Case 2 Restriction Type) to prevent settlement of the instructions of the suspended client with immediate effect⁸² and;

⁸¹ Some of the restriction rules defined in this context may serve other purposes as well.

⁸² This supposes that the corresponding restriction type is created and active, which takes 1 day minimum for Case 2 Restriction Type.

- Reject all new incoming instructions of the suspended client (Case 1 Restriction Type). From a technical perspective, it must be stressed that in case of update of an existing restriction rule or creation of a new one, it could only be valid as of the next business day at the earliest⁸³. The way to overcome this limitation is to define a restriction rule based on the usage of MSAs at account and/or party level, and to update the status of the relevant account/party to activate the rule on this object.

The description of current services and controls, restrictions rules, and impact analysis by market is detailed in the next sections. Please note that for those CSDs that have not defined restriction rules for Insolvency procedures an explanation is given. The purpose of this so-called “Sanity Check”⁸⁴ is to confirm to the T2S community that all CSDs have a common understanding of the tools they can use to control settlement in T2S, while ensuring a fair application of the methodology based on accurate and exhaustive information.

It is important to highlight that controls in the form of restriction rules for handling the suspension of a participant (or its underlying securities accounts, or securities if an issuer is insolvent) are required to be implemented by all CSDs in T2S that have DCP or cross-CSD activity, regardless of their role as Issuer/Investor CSD.

4.5.1 Baltic CSDs

Pre T2S – Process Controls

Prior to T2S, Baltic CSDs (Estonia, Latvia, and Lithuania) have put in place adequate controls on their legacy platforms to manage the insolvency of their participants.

Adapted State – Process Controls

In the context of Insolvency Procedures, the Baltic CSDs plan to define the following restriction rules:

Rejection (Case 1 Restriction Type):

- BCDR01(A): a positive rejection rule to reject all settlement instructions sent by CSD participants on accounts with status “Fully Suspended” (identified with MSA).

The parameters configured in this rule are listed below:

- “Account Status” (MSA on securities account), with value:
 - Fully Suspended
- Party Type (of the instructing party), with value:
 - CSD Participant

⁸³ This supposes that the corresponding restriction type is created and active, which takes 2 days minimum for Case 1 Restriction Type.

⁸⁴ During the ad-hoc CSG meeting held on 29 July 2015, the CSG adopted the proposal by the T2S Programme Manager to perform the so-called “Restriction Rules Sanity Check” for those cases where a majority of CSDs have defined restriction rules for a business process while other CSDs plan to implement this process without restriction rules in T2S (in particular in the context of Corporate Actions and Insolvency Procedures).

- BCDR01(B): a positive rejection rule to reject all settlement instructions sent by CSD participants on parties with status “Fully Suspended” (identified with MSA).

The parameters configured in this rule are listed below:

- “Party Status” (MSA on party), with value:
 - Fully Suspended
- Party Type (of the instructing party), with value:
 - CSD Participant
- BCDR03(A): a positive rejection rule to reject all delivering settlement instructions sent by CSD participants on accounts with status “Delivery Suspended” or “Blocked” (both identified with MSA configured as “Debit”).

The parameters configured in this rule are listed below:

- “Account Status” (MSA on securities account), with value:
 - Delivery Suspended
- “Account Blocked” (MSA on securities account), with value:
 - Blocked
- Party Type (of the instructing party), with value:
 - CSD Participant
- Securities Movement Type, with value:
 - DELI
- BCDR03(B): a positive rejection rule to reject all delivering settlement instructions sent by CSD participants on parties with status “Delivery Suspended” (identified with MSA configured as “Debit”).

The parameters configured in this rule are listed below:

- “Party Status” (MSA on party), with value:
 - Delivery Suspended
- Party Type (of the instructing party), with value:
 - CSD Participant
- Securities Movement Type, with value:
 - DELI
- BCDR04(A): a positive rejection rule to reject all receiving settlement instructions sent by CSD participants on accounts with status “Receive Suspended” (identified with MSA configured as “Credit”).

The parameters configured in this rule are listed below:

- “Account Status” (MSA on securities account), with value:
 - Receive Suspended
- Party Type (of the instructing party), with value:
 - CSD Participant
- Securities Movement Type, with value:

- RECE
- BCDR04(B): a positive rejection rule to reject all receiving settlement instructions sent by CSD participants on parties with status “Receive Suspended” (identified with MSA configured as “Credit”).

The parameters configured in this rule are listed below:

- “Party Status” (MSA on party), with value:
 - Receive Suspended
- Party Type (of the instructing party), with value:
 - CSD Participant
- Securities Movement Type, with value:
 - RECE

Blocking (Case 2 Restriction Type):

- BCDR14(A): a negative blocking restriction defined so that all settlement instructions on a given securities account are blocked upon request of the competent authority, except for settlement instructions sent by Baltic CSDs using the ISO transaction codes “CORP”, “ISSU”, or “REDM”, used in the context of CA and Issuance operations.

The parameters configured in this rule are listed below:

- Party Type (of the instructing party), with value:
 - CSD
- Transaction Identification, with values:
 - CORP;
 - ISSU; or
 - REDM.

- BCDR14(B): a negative blocking restriction defined so that all settlement instructions on a given party are blocked upon request of the competent authority, except for settlement instructions sent by Baltic CSDs using the ISO transaction codes “CORP”, “ISSU”, or “REDM”, used in the context of CA and Issuance operations.

The parameters configured in this rule are listed below:

- Party Type (of the instructing party), with value:
 - CSD
- Transaction Identification, with values:
 - CORP;
 - ISSU; or
 - REDM.

- BCDR14(C): a negative blocking restriction defined so that all settlement instructions on a given ISIN are blocked upon request of the competent authority, except for settlement instructions sent by Baltic CSDs using the ISO transaction codes “CORP”, “ISSU”, or “REDM”.

The parameters configured in this rule are listed below:

- Party Type (of the instructing party), with value:
 - CSD
- Transaction Identification, with values:
 - CORP;
 - ISSU; or
 - REDM.
- BCDR16(A): a negative blocking restriction defined so that all delivering settlement instructions on a given securities account are blocked upon request of the competent authority, except for settlement instructions sent by Baltic CSDs using the ISO transaction codes “CORP”, “ISSU”, or “REDM” , used in the context of CA and Issuance operations.

The parameters configured in this rule are listed below:

- Party Type (of the instructing party), with value:
 - CSD
- Transaction Identification, with values:
 - CORP;
 - ISSU; or
 - REDM.
- Securities Movement Type, with value:
 - RECE
- BCDR16(B): a negative blocking restriction defined so that all delivering settlement instructions on a given party are blocked upon request of the competent authority, except for settlement instructions sent by Baltic CSDs using the ISO transaction codes “CORP”, “ISSU”, or “REDM” , used in the context of CA and Issuance operations.

The parameters configured in this rule are listed below:

- Party Type (of the instructing party), with value:
 - CSD
- Transaction Identification, with values:
 - CORP;
 - ISSU; or
 - REDM.
- Securities Movement Type, with value:
 - RECE
- BCDR17(A): a negative blocking restriction defined so that all receiving settlement instructions on a given securities account are blocked upon request of the competent authority, except for settlement instructions sent by Baltic CSDs using the ISO transaction codes “CORP”, “ISSU”, or “REDM”.

The parameters configured in this rule are listed below:

- Party Type (of the instructing party), with value:
 - CSD
- Transaction Identification, with values:
 - CORP;
 - ISSU; or
 - REDM.
- Securities Movement Type, with value:
 - DELI
- BCDR17(B): a negative blocking restriction defined so that all receiving settlement instructions on a given party are blocked upon request of the competent authority, except for settlement instructions sent by Baltic CSDs using the ISO transaction codes “CORP”, “ISSU”, or “REDM”, used in the context of CA and Issuance operations.

The parameters configured in this rule are listed below:

- Party Type (of the instructing party), with value:
 - CSD
- Transaction Identification, with values:
 - CORP;
 - ISSU; or
 - REDM.
- Securities Movement Type, with value:
 - DELI

Cross-CSD Impact Analysis

Impact on Investor CSD account configuration

The restriction rules “BCDR01(B)”, “BCDR03(B)”, “BCDR04(B)”, “BCDR14(A)”, “BCDR14(B)”, “BCDR14(C)”, “BCDR16(A)”, “BCDR16(B)”, “BCDR17(A)”, and “BCDR17(B)” do not rely on account configuration parameters and the business process does not require segregation of securities positions, while “BCDR01(A)”, “BCDR03(A)”, and “BCDR04 (A)” rely on the usage of MSA(s) defined at securities account level. From the Investor CSD standpoint, in case the insolvent participant is also participant in an Investor CSD, the suspension of its account(s) would also be required in the Investor CSD.

Impact on Investor CSD settlement flows

The restriction rules “BCDR01(A)”, “BCDR01(B)”, “BCDR03(A)”, “BCDR03(B)”, “BCDR04(A)”, and “BCDR04(B)” defined at the level of settlement instruction (object restriction type: settlement instruction) would impact Investor CSDs’ settlement flows as follows (please check in the above section the parameters of each individual rule to determine the trigger for the rejection):

- In case of a cross-CSD transaction between an insolvent participant of the Baltic CSDs (suspended at party level or account level) and a participant of an Investor CSD, the Business Instruction sent by the

insolvent participant of the Baltic CSDs would be rejected and the Business Instruction at the Investor CSD level would remain unmatched.

- In other cross-CSD scenarios generating realignments at the Baltic CSDs (i.e. between Investor CSDs' participants or a participant of the Baltic CSDs and a participant of an Investor CSD), realignment instructions on an omnibus account owned by an insolvent Investor CSD would not be generated and the Business Instructions would be cancelled after acceptance and matching.

The restriction rules "BCDR14(A)", "BCDR14(B)", "BCDR16(A)", "BCDR16(B)", "BCDR17(A)" and "BCDR17(B)" would impact Investor CSDs' settlement flows as follows (please check in the above section the parameters of each individual rule to determine the trigger for the blocking):

- In case of a cross-CSD transaction between an insolvent participant of the Baltic CSDs (suspended at party level or account level) and a participant of an Investor CSD, the transaction will not be eligible for settlement while the restriction applies.
- In other cross-CSD scenarios generating realignment movements at the Baltic CSDs (i.e. between Investor CSDs' participants or a participant of the Baltic CSDs and a participant of an Investor CSD), if the party/securities account being blocked is/belongs to one of the Investor CSDs, the transaction will not be eligible for settlement while the restriction applies.

The restriction rule "BCDR14(C)" would impact Investor CSDs' settlement flows involving the blocked security as follows:

- In case of a cross-CSD transaction between a participant of the Baltic CSDs and a participant of an Investor CSD on the blocked ISIN, the transaction will not be eligible for settlement while the blocking applies.
- In other cross-CSD scenarios generating realignment movements at the Baltic CSDs (i.e. between Investor CSDs' participants), the transaction on the blocked ISIN would not be eligible for settlement while the restriction applies.

In general, in the event of insolvency of a participant, if the suspended participant is also participant of an Investor CSD, the Investor CSD would need to activate similar restrictions in its data scope, i.e. reject/block settlement for the affected party or on the relevant securities accounts. Indeed, Intra-CSD transactions at an Investor CSD on a participant suspended at the Baltic CSDs (party or relevant securities accounts) would not be prevented by the Baltic CSDs' rules. In the particular case of an ISIN being blocked at the Baltic CSDs as resulting from the insolvency of a participant, Investor CSDs would have to assess the need for applying a similar rule as the one implemented by the Baltic CSDs depending on the scenario.

Furthermore, each CSD having DCP or cross-CSD activity in T2S should have controls in the form of restriction rules in place for the case of insolvency of one of its participant.

4.5.2 BOGS

Pre T2S – Process Controls

In case of insolvency of a participant, BOGS prevents settlement of new incoming instructions sent by a specific participant. The procedure is initiated upon request of the competent authority.

Adapted State – Process Controls

In order to prevent settlement of new incoming instructions upon suspension of a party or a specific securities account, BOGS has defined the following restriction rules:

- “RT05”, a positive CSD Validation Hold rule (Case 1 Restriction Type) will be defined in order to put on hold delivering / receiving settlement instructions sent by suspended CSD participants (MSA at party level: Suspended = ‘YES’).
- “RT06”, a positive CSD Validation Hold rule (Case 1 Restriction Type) will be defined in order to put on hold delivering / receiving settlement instructions sent on suspended securities accounts (MSA at securities account level: SuspSecAccount = ‘YES’)

Two MSAs are used to identify whether the participants in BOGS or specific securities accounts are suspended.

The parameters configured in the rule are listed below:

- Security Movement Type: DELI (delivering leg), RECE (receiving leg)
- Instructing Party Type: CSD participant
- Suspended⁸⁵ = ‘YES’
- SuspSecAccount⁸⁶ = ‘YES’

Cross-CSD Impact Analysis

Impact on Investor CSD account configuration

The restriction rule “RT05” does not rely on account configuration parameters and the business process does not require segregation of securities positions, while “RT06” relies on the usage of an MSA defined at securities account level. In case the insolvent participant is also participant in an Investor CSD, the suspension of its account(s) would also be required in the Investor CSD.

Impact on Investor CSD settlement flows

⁸⁵ MSA Party Attributes are configured as ‘DEBIT’ or ‘CREDIT’ in the rule in order to ensure that delivering settlement instructions only check the delivering party BIC against the MSA value and receiving settlement instructions only the receiving party BIC against the MSA value

⁸⁶ MSA Account Attributes are configured as ‘DEBIT’ or ‘CREDIT’ in the rule in order to ensure that delivering settlement instructions only check the delivering securities account against the MSA value and receiving settlement instructions only the receiving securities accounts against the MSA value

The restriction rule “RT05” (suspension of a participant) would impact Investor CSDs’ settlement flows in the following scenarios:

- In case of a cross-CSD transaction between a suspended participant of BOGS and a participant of an Investor CSD, the Business Instruction sent by the suspended participant of BOGS matching the rule parameters will be put on CSD Validation Hold and the transaction will remain pending for settlement.
- In other cross-CSD scenarios generating realignments at BOGS (between Investor CSDs’ participants or a participant of BOGS and a participant of an Investor CSD), realignment instructions matching the rule parameters on an omnibus account owned by a suspended Investor CSD would be put on CSD Validation Hold and the transaction will remain pending for settlement.

At this stage, the transaction would potentially need to be cancelled, bilaterally with the involvement of Investor CSD(s) or T2S operator mandated accordingly.

The restriction rule “RT06” (suspension of a securities account) would impact Investor CSDs’ settlement flows in the following scenarios:

- In case of a cross-CSD transaction between a participant of BOGS and a participant of an Investor CSD, if the account included in the Business Instruction sent by BOGS’ participant is suspended, the Business Instruction of BOGS’ participant will be put on CSD Validation Hold and the transaction will remain pending for settlement.
- In other cross-CSD scenarios generating realignments at BOGS (between Investor CSDs’ participants or a participant of BOGS and a participant of an Investor CSD), realignment instructions matching the rule parameters on a suspended omnibus account would be put on CSD Validation Hold and the transaction will remain pending for settlement.

At this stage, the transaction would potentially need to be cancelled, bilaterally with the involvement of Investor CSD(s) or T2S operator mandated accordingly.

In the event of insolvency of a participant, in case the suspended participant is also participant of an Investor CSD, the Investor CSD would need to activate similar restrictions in its data scope, i.e. block settlement for the affected party or on the relevant securities accounts. Indeed, Intra-CSD transactions at an Investor CSD on a participant suspended at BOGS (party or relevant securities accounts) would not be prevented by the rules.

Regardless of this latter scenario, each CSD having DCP or cross-CSD activity in T2S should have controls in the form of restriction rules in place for the case of insolvency of one of its participant.

4.5.3 Clearstream Banking Frankfurt (CBF)

For insolvency procedures, CBF will re-use existing Case 2 restriction rules “Party Blocking” and “Account Blocking” initially defined to block a party or an account prior to its deletion. These restriction rules are currently described in the section “4.16 Static Data Configuration”.

4.5.4 Depozitarul Central

Pre T2S – Process Controls

In case of insolvency of a participant, Depozitarul Central controls the acceptance of new settlement instructions on a particular party by maintaining an attribute to indicate the status of the party. The suspension can be enforced by the competent authorities but can also stem from Depozitarul Central's regulatory framework.

Acceptance of new incoming instructions is only allowed in case that the status assigned to the party is not "suspended".

Adapted State – Process Controls

In order to stop acceptance of new incoming settlement instructions upon suspension of a party, Depozitarul Central has defined the following restriction rule: RT01DC, a positive rejection rule (Case 1 Restriction Type) is defined in order to reject settlement instructions sent by suspended CSD participants.

An MSA is used to define the eligibility status of the participants defined in Depozitarul Central (Participant Status).

While acceptance of new incoming instructions on suspended CSD participants is prevented by the restriction rules RT01DC, settlement of pending transactions received in T2S prior to the suspension is allowed.

Rejection (Case 1 Restriction Type)

"RT01DC" - rejects settlement instructions by CSD participants under the status "Suspended".

The parameters configured in the rule are listed below:

- Participant status (MSA on parties):
 - Suspended
- Party type of the instructing party:
 - CSD Participant

Cross-CSD Impact Analysis

Impact on Investor CSD account configuration

The restriction rule "RT01DC" does not rely on account configuration parameters and the business process does not require segregation of securities positions. No impact on the Investor CSDs' account configuration has been identified. However, in case a participant is also participant in an Investor CSD, the blocking or suspension of the party would also be required in the Investor CSD.

Impact on Investor CSD settlement flows

Depozitarul Central's restriction rule "RT01DC" (suspension of a participant) would impact Investor CSDs' settlement flows as follows:

- In case of a cross-CSD transaction between a suspended participant of Depozitarul Central and a participant of an Investor CSD, the Business Instruction sent by the suspended participant of Depozitarul Central would be rejected and the Business Instruction at the Investor CSD level would remain unmatched.
- In other cross-CSD scenarios generating realignments at Depozitarul Central (i.e. between Investor CSDs' participants or a participant of Depozitarul Central and a participant of an Investor CSD), realignment instructions on an omnibus account owned by a suspended Investor CSD would not be generated and the Business Instructions would be cancelled after acceptance and matching.

In case a suspended participant is also participant of an Investor CSD, the blocking or suspension of the party would also be required to be activated in the Investor CSD's data scope, and a restriction rule should be in place to cope with this scenario. Indeed, intra-CSD transactions at an Investor CSD on a party that is suspended at Depozitarul Central would not be prevented by the rules.

Regardless of this latter scenario, each CSD having DCP or cross-CSD activity in T2S should have controls in the form of restriction rules in place for the case of insolvency of one of its participant.

4.5.5 ESES (Euroclear Belgium, Euroclear France, Euroclear Netherlands)

Pre T2S – Process Controls

ESES performs blocking of a securities account upon request of the competent authority preventing settlement of any transaction against the blocked account; e.g. if an institution is suspended by the NCB from issuing TCN (Money Market Instruments), ESES blocks its issuing account. In this case, no debit instruction is allowed on the considered account. Similarly, ESES may need to block all settlement instructions of a specific party.

Adapted State – Process Controls

ESES has defined restriction rules through intraday restrictions (Case 2 Restriction Type) for blocking delivering settlement instructions on securities accounts "ESE-001-REC" ("RT01") or parties "ESE-044-REC" ("RT09").

Blocking (Case 2 Restriction Type)

- "RT01"- "ESE-001-REC" (positive rule) - blocks settlement of delivering settlement instructions (configured with rule parameter "Securities movement type: DELI") on a suspended securities account upon request of the competent authority.
- RT09 -"ESE-044-REC" (negative rule) - prevents settlement of settlement instructions (configured with parameter "Securities movement type: DELI") on suspended parties upon request of the competent authority, except if sent with the following transaction codes:
 - CORP: for allowing Corporate Actions to be processed
 - AUTO: for allowing reimbursement of auto-collateralisations instructions

- TURN: for allowing specific instructions sent by ESES in contingency scenarios
- REAL: for allowing realignment instructions
- INSP: for allowing specific instructions sent by ESES Operations in the context of issuance

Cross-CSD Impact Analysis

Impact on Investor CSD account configuration

The restriction rules “ESE-001-REC” (“RT_01”) and ESE-044-REC” (“RT_09”) do not rely on account configuration parameters and the business process does not require segregation of securities positions. No impact on the Investor CSD account configuration has been identified. However, the blocking of the underlying participants accounts may be required if these are also participants of the Investor CSD.

Impact on Investor CSD settlement flows

The restriction rule “ESE-001-REC” (“RT_01”) would have an impact on cross-CSD transactions involving the blocked securities account(s):

- In case of a cross-CSD transaction between a participant of ESES as delivering party (suspended at account level) and a participant of an Investor CSD, the transaction will not be eligible for settlement while the restriction applies.
- In other cross-CSD scenarios generating realignment movements at ESES, in the specific case where the securities account being blocked is owned by an Investor CSD, the transaction will not be eligible for settlement while the restriction applies.

At this stage, the transaction would potentially need to be cancelled, bilaterally with the involvement of Investor CSD(s).

The restriction rule ESE-044-REC” (“RT_09”) would have an impact on cross-CSD transactions involving the blocked party:

- In case of a cross-CSD transaction between a participant of ESES that has been suspended and a participant of an Investor CSD, the transaction will not be eligible for settlement while the restriction applies.
- In other cross-CSD scenarios generating realignment movements at ESES, the transaction will not be blocked for settlement as realignment instructions are bypassing the rule. In the very specific case where the Investor CSD would need to be blocked, this restriction rule would not be suitable.

In case a suspended participant is also participant in an Investor CSD, the blocking or suspension of the party (and/or its underlying securities accounts) would also be required to be activated in the Investor CSD’s data scope, and a restriction rule should be in place to cope with this scenario. Indeed, intra-CSD transactions at an Investor CSD on a party that is suspended at ESES would not be prevented by the rules.

Regardless of this latter scenario, each CSD having DCP or cross-CSD activity in T2S should have controls in the form of restriction rules in place for the case of insolvency of one of its participant.

4.5.6 Euroclear Finland

Pre T2S – Process Controls

In case of insolvency of a participant, Euroclear Finland controls the acceptance of new settlement instructions on a particular party by maintaining an attribute to indicate the status of the party. The suspension can be enforced by the competent authorities but can also stem from Euroclear Finland's regulatory framework.

Acceptance of new incoming instructions is not allowed in case that the status assigned to the party is "Suspended".

Adapted State – Process Controls

Euroclear Finland's legal team requires to keep the same process implemented in the internal system in case of insolvency and therefore, in addition to the Case 4 Restriction Type built-in in T2S for insolvency of a participant (CR558), Euroclear Finland plans to use a restriction rule for the case of insolvency of a participant to reject instructions at business validation level for participants with status "suspended". Case 4 Restriction Type in combination with the insolvency flag will therefore reject debit of participants securities accounts and debit of cash account for new incoming instructions.

Rejection (Case 1 Restriction Type):

"PSUS (A)": rejects settlement instructions on parties with status "Suspended" (identified with MSA).

The parameter configured in the rule is listed below:

- "BPSTATUS" (MSA on party level), with value:
 - Suspended

Cross-CSD Impact Analysis

Impact on Investor CSD account configuration

The restriction rule "PSUS (A)" does not rely on account configuration parameters and the business process does not require segregation of securities positions. No impact on the Investor CSDs' account configuration has been identified. However, in case a participant is also participant in an Investor CSD, the blocking or suspension of the party would also be required in the Investor CSD.

Impact on Investor CSD settlement flows

Euroclear Finland's restriction rule "PSUS (A)" (suspension of a participant) would impact Investor CSDs' settlement flows as follows:

- In case of a cross-CSD transaction between a suspended participant of Euroclear Finland and a participant of an Investor CSD, the Business Instruction sent by the suspended participant of

Euroclear Finland would be rejected and the Business Instruction at the Investor CSD level would remain unmatched. No realignment will be triggered for this transaction.

- In other cross-CSD scenarios triggering realignment at Euroclear Finland on an omnibus account owned by a suspended Investor CSD, realignment instructions would not be generated and the Business Instructions would be cancelled after acceptance and matching.

In case a suspended participant is also participant of an Investor CSD, the blocking or suspension of the party would also be required to be activated in the Investor CSD's data scope, and a restriction rule should be in place to cope with this scenario. Indeed, intra-CSD transactions at an Investor CSD on a party that is suspended at Euroclear Finland would not be prevented by this rule.

Regardless of this latter scenario, each CSD having DCP or cross-CSD activity in T2S should have controls in the form of restriction rules in place for the case of insolvency of one of its participant.

4.5.7 Interbolsa

Interbolsa is waiting for the outcome of the dedicated CSG Task Force on Insolvency, which aims at defining a common procedure to apply in case of insolvency of a T2S participant.

4.5.8 KELER

Pre T2S – Process Controls

In the context of insolvency of a participant, a court order enforced by KELER can result in the suspension of the right of disposal over an account by which only some authorised actors are entitled to exercise the right of disposal (the account is blocked by KELER) or in proceedings to restrict payment, by which KELER shall stop acceptance of transfer orders of the suspended client.

Adapted State – Process Controls

KELER has defined restriction rules in order to reject (Case 1 Restriction Type) new incoming settlement instructions and restrictions on securities accounts or sent by parties that have specific statuses (see details in parameter rule descriptions) different than “Active”. MSAs are used to define the status of securities accounts (Account status), as well as parties (Party Status).

KELER will also activate intraday restrictions (Case 2 Restriction Type) on parties and securities accounts in the context of insolvency, to block all related settlement activity on these objects.

Rejection (Case 1 Restriction Type)

“RT01_Party_Reject” - rejects delivering⁸⁷ settlement instructions and settlement restrictions sent by CSD participants with specific statuses different than “Active”, except if settlement instructions are sent with the ISO transaction code “CORP”.

⁸⁷ For MSA status = Suspended, with MSA Party configured as Debit in the rule configuration. For status = To be Deleted, both delivering and receiving settlement instructions are considered.

The parameters configured in the rules are listed below:

- “Party status” (MSA on party level, with the following (non-exhaustive list of values):
 - Suspended
- Transaction identification (ISO transaction code):
 - CORP
- Securities Movement Type:
 - DELI

“RT03_Account_Reject” - rejects delivering⁸⁸ settlement instructions and settlement restrictions on securities accounts with specific statuses different than “Active”, except if settlement instructions are sent with the ISO transaction code “CORP”.

The parameters configured in the rules are listed below:

- “Account status” (MSA on securities accounts), with the following (non-exhaustive list of values):
 - Suspended
 - Frozen
 - Dormant
- Transaction identification (ISO transaction code):
 - CORP
- Securities Movement Type:
 - DELI

Blocking - negative (Case 2 Restriction Type)

“RT02_Party_Block” - blocks settlement instructions on specific parties in the context of insolvency (i.e. instructions are not eligible for settlement while the blocking applies), except if instructed with the ISO transaction code “CORP”.

The parameters configured in the rules are listed below:

- Transaction identification (ISO transaction code):
 - CORP

“RT04_Account_Block” – blocks either delivering or receiving settlement instructions on specific securities accounts in the context of insolvency (i.e. instructions are not eligible for settlement while the blocking applies), except if instructed with the ISO transaction code “CORP”.

The parameters configured in the rules are listed below:

- Transaction identification (ISO transaction code):

⁸⁸ For MSA status = Suspended, with MSA Securities Account configured as Debit in the rule configuration. For other statuses, both delivering and receiving settlement instructions are considered.

- CORP
- Securities Movement Type:
 - DELI
 - RECE

Cross-CSD Impact Analysis

Impact on Investor CSD account configuration

The restriction rules “RT01_Party_Reject”, “RT02_Party_Block”, “RT04_Account_Block” do not rely on account configuration parameters and the business process does not require segregation of securities positions, while “RT03_Account_Reject” relies on the usage of an MSA defined at securities account level. In case the insolvent participant is also participant in an Investor CSD, the suspension of its account(s) would also be required in the Investor CSD.

Impact on Investor CSD settlement flows

The restriction rule “RT01_Party_Reject” defined at the level of settlement instruction (object restriction type: settlement instruction) would impact Investor CSDs’ settlement flows as follows:

- In case of a cross-CSD transaction between an insolvent participant of KELER delivering securities and a participant of an Investor CSD, the Business Instruction sent by the insolvent participant of KELER would be rejected and the Business Instruction at the Investor CSD level would remain unmatched.
- In other cross-CSD scenarios generating realignments at KELER (i.e. between Investor CSDs’ participants or a participant of KELER and a participant of an Investor CSD), realignment instructions on an omnibus account owned by an insolvent Investor CSD would not be generated and the Business Instructions would be cancelled after acceptance and matching.

The restriction rule “RT01_Party_Reject” defined at the level of settlement restriction (object restriction type: settlement restriction) will not impact Investor CSDs’ settlement flows, except if an insolvent Investor CSD (e.g. Party status “suspended”) would instruct an intra-position movement directly on its omnibus account. Investor CSDs may consider implementing the rule depending on their operating model (i.e. creation of position types) and internal rules and procedures.

The restriction rule “RT02_Party_Block” would impact Investor CSDs’ settlement flows as follows:

- In case of a cross-CSD transaction between an insolvent participant of KELER and a participant of an Investor CSD, the transaction will not be eligible for settlement while the restriction applies.
- In other cross-CSD scenarios generating realignment movements at KELER, if the party being blocked is one of the Investor CSDs’, the transaction will not be eligible for settlement while the restriction applies.

In case the insolvent participant is also participant of an Investor CSD, the blocking or suspension of the party would also be required to be activated in the Investor CSD’s data scope, and a restriction rule

should be in place to cope with this scenario. Indeed, intra-CSD transactions at an Investor CSD on a party that is subject to insolvency proceedings at KELER would not be prevented by the rules.

The restriction rule “RT03_Account_Reject” defined at the level of settlement instruction (object restriction type: settlement instruction) would impact Investor CSDs’ settlement flows as follows:

- In case of a cross-CSD transaction between an insolvent participant of KELER delivering securities and a participant of an Investor CSD, the Business Instruction sent by the participant of KELER on the suspended securities account would be rejected and the Business Instruction at the Investor CSD level would remain unmatched.
- In other cross-CSD scenarios generating realignments at KELER (i.e. between Investor CSDs’ participants or a participant of KELER and a participant of an Investor CSD), realignment instructions on an omnibus account owned by a suspended Investor CSD would not be generated and the Business Instructions would be cancelled after acceptance and matching.

The restriction rule “RT03_Account_Reject” defined at the level of settlement restriction (object restriction type: settlement restriction) will not impact Investor CSDs’ settlement flows, except if an insolvent Investor CSD whose account is subject to rejection (e.g. Account status “suspended”) would instruct an intra-position movement directly on its omnibus account. Investor CSDs may consider implementing the rule depending on their operating model (i.e. creation of position types) and internal rules and procedures.

The restriction rule “RT04_Account_Block” would impact Investor CSDs’ settlement flows as follows:

- In case of a cross-CSD transaction between an insolvent participant of KELER whose account is blocked and a participant of an Investor CSD, the transaction will not be eligible for settlement while the restriction applies⁸⁹.
- In other cross-CSD scenarios generating realignment movements at KELER, if the securities account being blocked is one of the Investor CSDs’, the transaction will not be eligible for settlement while the restriction applies.

In case the insolvent participant is also participant of an Investor CSD, the blocking or suspension of the related securities account would also be required to be activated in the Investor CSD’s data scope, and a restriction rule should be in place to cope with this scenario. Indeed, intra-CSD transactions at an Investor CSD on a securities account that is subject to insolvency proceedings at KELER would not be prevented by the rules.

Regardless of this latter scenario, each CSD having DCP or cross-CSD activity in T2S should have controls in the form of restriction rules in place for the case of insolvency of one of its participant.

⁸⁹ Note that depending on the restriction type applied, either only delivering or only receiving settlement instructions would be blocked.

4.5.9 LuxCSD

Feedback on the Restriction Rules Sanity Check is pending.

4.5.10 Malta Stock Exchange

Feedback on the Restriction Rules Sanity Check is pending.

4.5.11 Monte Titoli

Pre T2S – Process Controls

Settlement on Parties, accounts and securities can be blocked by Monte Titoli according to the regulatory framework or upon reception of a court order enforced against a client of Monte Titoli (e.g. in case of insolvency).

Adapted State – Process Controls

Monte Titoli has defined restriction rules in T2S in order to block (Case 2 Restriction Type) parties, securities or securities accounts following e.g. a court order enforced against a client of Monte Titoli.

Blocking (Case 2 Restriction Type)

“BLSC” – blocks settlement of a specific ISIN due to events such as (but not exclusively) default of a participant (issuer or intermediary), judicial authority instruction.

“BLPY” – blocks settlement of instructions by a given party due to events such as (but not exclusively) default of a participant (issuer or intermediary), judicial authority instruction.

“BLSA” – blocks settlement on specific securities account due to events such as (but not exclusively) default of a participant (issuer or intermediary), judicial authority instruction.

Cross-CSD Impact Analysis

Impact on Investor CSD account configuration

The restriction rules “BLSC”, “BLPY” and “BLSA” do not rely on account configuration parameters and the business process does not require segregation of securities positions. No impact on Investor CSDs’ account configuration has been identified. However, in case a participant is also participant in an Investor CSD, the blocking of its account(s) may also be required in the Investor CSD.

Impact on Investor CSD settlement flows

The restriction rules “BLSC”, “BLPY” and “BLSA” would have an impact on any cross-CSD transaction involving the blocked party, account or security:

- In case of a cross-CSD transaction that involves a blocked static data object (account, party, or security) between a participant of Monte Titoli and a participant of an Investor CSD, the transaction would not be eligible for settlement while the blocking applies.

- In case of a cross-CSD transaction between Investor CSDs’ participants generating realignment movements at Monte Titoli:
 - For “BLPY” and “BLSA” in the specific case where the account is owned by an Investor CSD or the party being blocked is one of the Investor CSDs, the transaction would not be eligible for settlement while the restriction applies.
 - For “BLSC”, any the transaction on the blocked ISIN would not be eligible for settlement while the restriction applies.

In the event of insolvency of a participant, in case the suspended participant is also participant of an Investor CSD, the Investor CSD would need to activate similar restrictions in its data scope, i.e. block settlement for the affected party, securities accounts, or securities. Indeed, intra-CSD transactions at an Investor CSD on a security, securities account, or party suspended at Monte Titoli would not be prevented by the rules.

Regardless of this latter scenario, each CSD having DCP or cross-CSD activity in T2S should have controls in the form of restriction rules in place for the case of insolvency of one of its participant.

4.5.12 NBB-SSS

Pre T2S – Process Controls

In case of insolvency of a participant, NBB-SSS prevents settlement of new incoming instructions sent by a specific participant, on a specific securities account, or on a specific security by maintaining the attribute to indicate the suspension status of the security, account, or participant to be used for settlement. The procedure is initiated upon request of the competent authority.

Adapted State – Process Controls

NBB-SSS has defined restriction rules in order to put on CSD Validation Hold (Case 1 Restriction Type) settlement instructions sent by a specific party, on a specific securities account, or on a specific security according to predefined statuses configured with MSAs.

“NBBE-RT10” will be defined to prevent settlement of new incoming instructions sent by a specific CSD participant. Depending on the status assigned to the party, the rule will prevent settlement of new incoming delivering, receiving, or all settlement instructions.

The parameters configured in the rules are listed below:

- ParticipantSuspension (MSA on party level), with the following values:
 - “D” for delivering settlement instructions
 - “R” for receiving settlement instructions
 - “A” for both delivering and receiving settlement instructions
- Securities Movement Type:
 - DELI (used in conjunction with the party MSA value “D”)
 - RECE (used in conjunction with the party MSA value “R”)

- Instructing Party Type, with the following values:
 - CSD Participant

“NBBE-RT11” will be defined to prevent settlement of new incoming instructions on a specific security⁹⁰. Depending on the status assigned to the security, the rule will prevent transfer of such securities to another party or settlement of all incoming instructions in that security.

The parameters configured in the rule are listed below:

- SecuritySuspension (MSA on security level), with the following values:
 - “F”: (foreign currency asset frozen period): all settlement instructions with a security in this status trigger the rule⁹¹
 - “G”: Global suspension of all instructions in that security

“NBBE-RT12” will be defined to prevent settlement of new incoming instructions on a specific account. Depending on the status assigned to the account, the rule will prevent settlement of new incoming delivering, receiving, or all settlement instructions.

The parameters configured in the rule are listed below:

- AccountSuspension (MSA on account level), with the following values:
 - “D” for delivering settlement instructions
 - “R” for receiving settlement instructions
 - “A” for both delivering and receiving settlement instructions
- Securities Movement Type:
 - DELI (used in conjunction with the account MSA value “D”)
 - RECE (used in conjunction with the account MSA value “R”)
- Instructing Party Type, with the following values:
 - CSD Participant

Cross-CSD Impact Analysis

Impact on Investor CSD account configuration

The restriction rules “NBBE-RT10” and “NBBE-RT11” do not rely on account configuration parameters and the business process does not require segregation of securities positions, while “NBBE-RT12” relies on the usage of an MSA defined at securities account level. In case the insolvent participant is also participant in an Investor CSD, the suspension of its account(s) would also be required in the Investor CSD.

⁹⁰ This restriction rule will also be used outside the context of insolvency procedures

⁹¹ The origin of this rule is a Belgian regulatory requirement: 1 open day before a coupon payment date or redemption date the security positions related to non-Euro cash payments (i.e. non-Euro denominated securities) can only change between the account of the same participant (Royal Decree of June 1994, Art 2, par 2.)

Impact on Investor CSD settlement flows

NBB-SSS' restriction rule "NBBE-RT10" (suspension of a participant) would impact Investor CSDs' settlement flows in the following scenarios:

- In case of a cross-CSD transaction between a suspended participant of NBB-SSS and a participant of an Investor CSD, the Business Instruction sent by the suspended participant of NBB-SSS matching the rule parameters (delivering, receiving, or all settlement instructions) will be put on CSD Validation Hold and the transaction will remain pending for settlement.
- In other cross-CSD scenarios generating realignments at NBB-SSS (between Investor CSDs' participants or a participant of NBB-SSS and a participant of an Investor CSD), realignment instructions matching the rule parameters (delivering, receiving, or all settlement instructions) on an omnibus account owned by a suspended Investor CSD would be put on CSD Validation Hold and the transaction will remain pending for settlement.

At this stage, the transaction would potentially need to be cancelled, bilaterally with the involvement of Investor CSD(s) or T2S operator mandated accordingly.

NBB-SSS' restriction rule "NBBE-RT11" (suspension of a security) would impact Investor CSDs' settlement flows in the following scenarios:

- In case of a cross-CSD transaction on a suspended security between a participant of NBB-SSS and a participant of an Investor CSD, the Business Instruction sent by the suspended participant of NBB-SSS will be put on CSD Validation Hold and the transaction will remain pending for settlement.
- In other cross-CSD scenarios generating realignments at NBB-SSS (between Investor CSDs' participants or a participant of NBB-SSS and a participant of an Investor CSD), realignment instructions matching the rule parameters (with global suspension "G", or "F" unless the delivery takes place between accounts of an Investor CSD) would be put on CSD Validation Hold and the transaction will remain pending for settlement.

At this stage, the transaction would potentially need to be cancelled, bilaterally with the involvement of Investor CSD(s).

NBB-SSS' restriction rule "NBBE-RT12" (suspension of a securities account) would impact Investor CSDs' settlement flows in the following scenarios:

- In case of a cross-CSD transaction between a participant of NBB-SSS and a participant of an Investor CSD, if the account included in the Business Instruction sent by the NBB-SSS' participant is suspended, the Business Instruction of the NBB-SSS participant will be put on CSD Validation Hold and the transaction will remain pending for settlement.
- In other cross-CSD scenarios generating realignments at NBB-SSS (between Investor CSDs' participants or a participant of NBB-SSS and a participant of an Investor CSD), realignment instructions matching the rule parameters (delivering, receiving, or all settlement instructions) on a

suspended omnibus account would be put on CSD Validation Hold and the transaction will remain pending for settlement.

At this stage, the transaction would potentially need to be cancelled, bilaterally with the involvement of Investor CSD(s) or T2S operator mandated accordingly.

In the event of insolvency of a participant, in case the suspended participant is also participant of an Investor CSD, the Investor CSD would need to activate similar restrictions in its data scope, i.e. block settlement for the affected party, securities accounts, or securities. Indeed, Intra-CSD transactions at an Investor CSD on a security, securities account, or party suspended at NBB-SSS would not be prevented by the rules.

Regardless of this latter scenario, each CSD having DCP or cross-CSD activity in T2S should have controls in the form of restriction rules in place for the case of insolvency of one of its participant.

4.5.13 OeKB CSD

Pre T2S – Process Controls

In case of insolvency, OeKB CSD performs blocking of a party and its underlying securities account(s) upon request of the competent authority, preventing settlement of any transaction against the blocked account(s) / party;

Adapted State – Process Controls

OeKB CSD has defined restriction rules through intraday restrictions (Case 2 Restriction Type) for blocking parties and underlying securities accounts declared insolvent.

Blocking (Case 2 Restriction Type)

- “R- 9” – the restriction will block settlement instructions sent by suspended parties
- “R-10” – the rule will block settlement instructions on suspended securities accounts
- R-11 - the rule will block settlement instructions on suspended securities accounts, except if sent with OeKB CSD’s CSD BIC as Instructing Party

Cross-CSD Impact Analysis

Impact on Investor CSD account configuration

The restriction rules “R-9”, “R-10”, and “R-11” do not rely on account configuration parameters and the business process does not require segregation of securities positions. No impact on the Investor CSD account configuration has been identified. However, the blocking of the underlying participants accounts may be required if these are also participants of the Investor CSD.

Impact on Investor CSD settlement flows

The restriction rules “R-9”, “R-10”, and “R-11” would have an impact on cross-CSD transactions involving the blocked party / securities account(s):

- In case of a cross-CSD transaction between a participant of OeKB CSD (suspended at party level or account level) and a participant of an Investor CSD, the transaction will not be eligible for settlement while the restriction applies.
- In other cross-CSD scenarios generating realignment movements at OeKB CSD, in the specific case where the securities account being blocked is owned by an Investor CSD, the transaction will not be eligible for settlement while the restriction applies.

At this stage, the transaction would potentially need to be cancelled, bilaterally with the involvement of Investor CSD(s).

In case a suspended participant is also participant in an Investor CSD, the blocking or suspension of the party (and/or its underlying securities accounts) would also be required to be activated in the Investor CSD's data scope, and a restriction rule should be in place to cope with this scenario. Indeed, intra-CSD transactions at an Investor CSD on a party that is suspended at OeKB CSD would not be prevented by the rules.

Regardless of this latter scenario, each CSD having DCP or cross-CSD activity in T2S should have controls in the form of restriction rules in place for the case of insolvency of one of its participant.

4.5.14 SIX-SIS

Pre T2S – Process Controls

In case of insolvency of a participant, SIX-SIS prevents acceptance of new settlement instructions (rejection) on a particular securities account or security by maintaining the attribute to indicate eligibility of the account or the security to be used for settlement. Eligibility can be updated due to various reasons such as restrictions on account owner by competent regulatory authorities.

Depending on the eligibility of a security account or security, acceptance of new settlement instructions is allowed or restricted:

- Acceptance of new incoming instructions is only allowed in case that the eligibility assigned to the security or securities account is “Active”.

Adapted State – Process Controls

SIX-SIS has defined restriction rules in order to reject (Case 1 Restriction Type) new incoming settlement instructions including securities accounts or securities with a status different than “Active”. MSAs are used to define the status of securities accounts (Account status), securities (Security status), as well as for the identification of DCPs (Party).

Rejection (Case 1 Restriction Type)

“RT01” - rejects settlement instructions on securities accounts with a status different than active.

The parameters configured in the rule are listed below:

- “Account status” (MSA on securities accounts), with the following (non-exhaustive list of values):

- “9 - Invalid”
- “4 - Frozen”
- “8 - Captured”
- “3 - To delete”
- “7- Deleted”
- “5 - Stop”

“RT02” - rejects settlement instructions on securities with a status different than active.

The parameters configured in the rule are listed below:

- “Securities status” (MSA on securities), with the following (non-exhaustive list of values):
 - “9 - Invalid”
 - “4 - Frozen”
 - “8 - Captured”
 - “3 - To delete”
 - “7- Deleted”
 - “5 - Stop”
- Instructing Party with the value of the DCP’s BIC

Cross-CSD Impact Analysis

Impact on Investor CSD account configuration

The restriction rule “RT02” does not rely on account configuration parameters and the business process does not require segregation of securities positions, while “RT01” relies on the usage of an MSA defined at securities account level. In case the insolvent participant is also participant in an Investor CSD, the suspension of its account(s) would also be required in the Investor CSD.

Impact on Investor CSD settlement flows

SIX-SIS’ restriction rule “RT01” would impact Investor CSDs’ settlement flows in the following scenarios:

- In case of a cross-CSD transaction between a participant of SIX-SIS whose account is not eligible (i.e. the status different than “Active”), and a participant of an Investor CSD, the Business Instruction of the SIX-SIS’ participant will be rejected and the Business Instruction at the Investor CSD level will remain unmatched.
- In other cross-CSD scenarios generating realignments at SIX-SIS (between two Investor CSDs’ participants or a participant of SIX-SIS and a participant of an Investor CSD), realignment instructions on suspended omnibus accounts (i.e. accounts under a status different than “Active”) will not be generated and the Business Instructions will be cancelled after acceptance and matching.

SIX-SIS’ restriction rule “RT02” would impact Investor CSDs’ settlement flows in the following scenarios:

- In case of a cross-CSD transaction between a participant of SIX-SIS and a participant of an Investor CSD on a non-eligible security, the Business Instruction sent by the participant of SIX-SIS will be rejected and the Business Instruction at the Investor CSD level will remain unmatched.
- In case of a cross-CSD transaction between two Investor CSDs involving realignments at SIX-SIS, realignment instructions on non-eligible securities (i.e. status different than “Active”) will not be generated and the Business Instructions will be cancelled after acceptance and matching.

In the event of insolvency of a participant, in case the suspended participant is also participant of an Investor CSD, the Investor CSD would need to activate similar restrictions in its data scope, i.e. block settlement for the affected party, securities accounts, or securities. Indeed, Intra-CSD transactions at an Investor CSD on a security, securities account, or party suspended at SIX-SIS would not be prevented by the rules.

Regardless of this latter scenario, each CSD having DCP or cross-CSD activity in T2S should have controls in the form of restriction rules in place for the case of insolvency of one of its participant.

4.5.15 VP Lux

Pre T2S – Process Controls

VPLux performs blocking of a securities account upon request of the competent authority, preventing settlement of any transaction against the blocked account. This process is typically applied for restrictive claims in the context of an insolvency of a participant.

Adapted State – Process Controls

In order to reflect the process above in T2S and achieve the required level of control, VPLux has implemented the following restriction rule:

- “RHGB”, a negative Case 2 Restriction Type, will be implemented in order to prevent settlement on a securities account on which there is a restrictive claim, e.g. in the context of an insolvency event. The restriction will not apply if the settlement instruction is sent with the “ISSU” ISO transaction code, i.e. in case of issuance operations.

Cross-CSD Impact Analysis

Impact on Investor CSD account configuration

The restriction rule “RHGB” does not rely on account configuration parameters and the business process does not require segregation of securities positions. No impact on Investor CSDs’ account configuration has been identified. However, in case a participant is also participant in an Investor CSD, the blocking of its account(s) may also be required in the Investor CSD.

Impact on Investor CSD settlement flows

The restriction rule “RHGB” would have an impact on any cross-CSD transaction involving the blocked securities account:

- In case of a cross-CSD transaction that involves a blocked securities account between a participant of VPLux and a participant of an Investor CSD, the transaction would not be eligible for settlement while the blocking applies.
- In case of a cross-CSD transaction between Investor CSDs' participants generating realignment movements at VPLux, in the specific case where the securities account being blocked is owned by an Investor CSD, the transaction would not be eligible for settlement while the restriction applies.

In the event of insolvency of a participant, in case the suspended participant is also participant of an Investor CSD, the Investor CSD would need to activate similar restrictions in its data scope, i.e. block settlement for the affected securities accounts. Indeed, intra-CSD transactions at an Investor CSD on a security, securities account, or party suspended at VPLux would not be prevented by the rules.

Regardless of this latter scenario, each CSD having DCP or cross-CSD activity in T2S should have controls in the form of restriction rules in place for the case of insolvency of one of its participant.

4.5.16 VP Securities

Pre T2S – Process Controls

VP performs blocking of a securities account upon request of the competent authority, preventing settlement of any transaction against the blocked account. This process is typically applied for restrictive claims in the context of an insolvency of a participant.

Adapted State – Process Controls

In order to reflect the process above in T2S and achieve the required level of control, VP has implemented the following restriction rule:

- “RHGB”, a negative Case 2 Restriction Type, will be implemented in order to prevent settlement on a securities account on which there is a restrictive claim, e.g. in the context of an insolvency event. The restriction will not apply if the settlement instruction is sent with the “ISSU” ISO or the “OWNI” ISO transaction codes, i.e. respectively in case of issuance operations or internal account transfers.

Conclusion

CSDs may be required to suspend the activity of a client in case of insolvency based on regulatory requirements from competent authorities, i.e. a court order, national regulator or national central bank.

With restriction rules, T2S offers CSDs with a toolkit to implement the controls related to Insolvency Procedures, e.g. in order to block the settlement activity of a client, on a specific account, or a security, or to prevent new settlement instructions to be accepted by the system. This can be achieved either at the level of business validation, to reject or put on hold settlement

instructions, or at the level of settlement eligibility, to prevent settlement on the suspended resource (i.e. intra-day restrictions on parties, securities accounts or securities). Blocking of securities holding into specific position types can also be used.

The table below underlines the differences among CSDs in the implementation of restriction rules for regulatory compliance:

Table 14 – Overview of usage of restriction rules for Insolvency Procedures

CSD	Type of restriction	Purpose of the rule	Number of MSAs
Baltic CSDs	Rejection (Case 1) Intraday blocking (Case 2)	Suspension of securities, accounts, parties	3
BOGS	CSD Validation Hold (Case 1)	Suspension of parties, accounts	2
Depozitarul Central	Rejection (Case 1)	Suspension of parties	1
ESES	Intraday blocking (Case2)	Suspension of securities, parties	0
Euroclear Finland	Rejection (Case 1)	Suspension of parties	1
KELER	Rejection (Case 1) Intraday blocking (Case 2)	Suspension of parties, accounts	2
Monte Titoli	Intraday blocking (Case2)	Suspension of securities, accounts, parties	0
NBB-SSS	CSD Validation Hold (Case1)	Suspension of securities, accounts, parties	3
OeKB CSD	Intraday blocking (Case 2)	Suspension of parties, accounts	0
SIX-SIS	Rejection (Case 1)	Suspension of securities, accounts	2
VPLux	Intraday blocking (Case2)	Suspension of securities accounts	0
VP Securities	Intraday blocking (Case2)	Suspension of securities accounts	0

As part of the “sanity check”, please note that Interbolsa has indicated that they are waiting for the outcome of the dedicated CSG Task Force on Insolvency to determine if current procedures need to be enriched. Feedback on LuxCSD and Malta Stock Exchange is pending. CBF have indicated that they will use existing Case 2 restriction rules defined in the context of static data management.

It is important to highlight that controls in the form of restriction rules for handling the suspension of a participant (or its underlying securities accounts, or securities if an issuer is insolvent) are required to be implemented by all CSDs in T2S that have DCP or cross-CSD activity, regardless of their role as Issuer/Investor CSD.

However, these controls seem to differ between CSDs, and based on the planned implementation of restriction rules, there will be a different treatment of settlement transactions involving e.g. a suspended client, depending on the CSD. Such discrepancies between T2S markets may to a certain extent have a legal origin, e.g. different implementation of the Settlement Finality Directive into national laws.

In some cases, CSDs decide to put on hold or reject new incoming instructions. The related restriction rules (Case 1 Restriction Type) are set up with MSAs on securities, parties or securities accounts defining the status indicating whether they are subject to a suspension. Baltic CSDs, BOGS, Depozitarul Central, Euroclear Finland, KELER, NBB-SSS, and SIX-SIS all have defined MSAs for this purpose (14 in total).

In other cases, CSDs decide to only prevent settlement of new and existing transactions by suspended clients, on suspended securities accounts or securities, while not preventing the validation of new incoming instructions. CSDs have set up restriction rules based on Case 2 Restriction Type to satisfy this purpose: Baltic CSDs, ESES, KELER, Monte Titoli OeKB CSD, VPLux and VP Securities will rely on this mechanism.

In the event of insolvency of a participant, in case the suspended participant is also participant of an Investor CSD, the Investor CSD would need to activate similar restrictions in its data scope (upon confirmation of the relevant competent authority for that market), i.e. block settlement for the affected party, securities accounts, or securities. It is important to remind that intra-CSD transactions at an Investor CSD on the suspended resource would not be prevented by the rules defined by the Issuer CSD.

The CSG Task Force on insolvency, while defining the procedures that CSDs will put in place in case of insolvency of a participant, has raised a number of Change Requests to ease the operational handling in case of insolvency. After implementation of CR558 in November 2016, a new restriction type that alleviates the need to define restriction rules and MSAs in the context of insolvency has been defined, and the XMAP will check with CSDs the need to define other restriction rules and MSAs in this context.

4.6 Other Regulatory Compliance

Introduction

For the assessment of restriction rules according to the methodology defined in Section 2.2 “Methodology to quantify impacts on Investor CSDs”, “Other Regulatory Compliance” is categorised as a necessary business process from an Investor CSD’s standpoint. Indeed, Investor CSDs must in general comply with the regulatory requirements defined within the Issuer CSD’s jurisdiction.

CSDs and NCBs have to comply with regulations put in place by the competent regulatory bodies, supervisors and authorities and, in some cases, are also responsible of ensuring that the transactions sent by participants are compliant with regulations and national laws.

In the context of this paper, the restriction rules categorised and analysed under “Other Regulatory Compliance” are implemented to comply with regulatory requirements coming from T2S markets’ jurisdictions which are not related to the insolvency of a participant. This categorisation is based on the feedback provided by the CSDs.

4.6.1 Baltic CSDs

Pre T2S – Process Controls

In Estonia, certain type of companies⁹² must register their securities in the Estonian CSD, regardless of the fact whether those companies are publicly listed or traded, as per legal requirement. Other types of limited liability companies⁹³ can also be registered in the CSD. As a result, 75% of securities registered in the Estonian CSD (4785 securities, as communicated in October 2016) carry a pre-emptive right for existing shareholders or have a restriction to be pledged, as they are not listed or traded in public. These however represent a very low volume of transactions, 3% or around 2000 per year.

In Latvia and Lithuania there is no mandatory requirement by Law but in Lithuania, many non-listed companies have also registered their securities in the CSD, these make up about 25% of all issuers in the Lithuanian CSD.

Those rules are materialised by adequate validation controls in the Baltic CSDs. For publicly traded companies, it is prohibited for issuers to define any kinds of transferability restrictions.

In another context, Baltic CSDs have put in place adequate controls in case a Court Order needs to be enforced against the client of a CSD participant.

Adapted State – Process Controls

⁹² Joint-stock companies (Aktsiaselts)

⁹³ Limited liability Companies (Osāhning)

In order to deal with restrictions related to non-public companies such as pre-emptive right for existing shareholders and interdiction to pledge securities, the Estonian and Lithuanian CSDs have defined the following restriction rules:

Rejection (Case 1 Restriction Type):

- ECDR11 (Estonian CSD only): a positive rejection rule to reject all receiving settlement instructions sent by CSD participants on pledge accounts (identified with MSA) if the security is non-pledgeable (identified with MSA).

The parameters configured in this rule are listed below:

- “Account Type” (MSA on securities account, configured in the rule parameters as “credit”), with value:
 - Pledge Account
- “Pledge Indicator” (MSA on securities), with value:
 - Non-pledgeable
- Party Type (of the instructing party), with value:
 - CSD Participant
- Securities Movement Type, with value:
 - RECE
- ECDR12 (Estonian CSD only): a positive rejection rule to reject all receiving settlement instructions sent by CSD participants on pledge accounts (identified with MSA) if the security’s authorisation to be pledged is subject to shareholders’ approval (identified with MSA).

The parameters configured in this rule are listed below:

- “Account Type” (MSA on securities account, configured in the rule parameters as “credit”), with value triggering rejection:
 - Pledge Account
- “Pledge Indicator” (MSA on securities), with value:
 - Decision required
- Party Type (of the instructing party), with value:
 - CSD Participant
- Securities Movement Type, with value:
 - RECE
- BCDR13 (Estonian and Lithuania CSDs): a positive rejection rule to reject all receiving settlement instructions on omnibus accounts of Investor CSDs if the security’s transferability is “restricted” (identified with MSA configured as “Debit”).

The parameters configured in this rule are listed below:

- “Transferability” (MSA on securities), with value:
 - Restricted
- Securities Account, with value:

- Omnibus account number of the Investor CSD
- Securities Movement Type, with value:
 - RECE

In order to enforce a Court Order against a client of a CSD participant, the Baltic CSDs have defined the following restriction rules to block securities in a specific sub-position:

Rejection (Case 1 Restriction Type):

- BCDR05: a positive rejection rule to reject all settlement instructions sent by CSD participants debiting the “STOP” sub-position.

The parameters configured in this rule are listed below:

- Party Type (of the instructing party), with value:
 - CSD Participant
- Debited Position/Balance, with value:
 - STOP

Reservation (Case 3 Restriction Type):

- “STOP”: reservation (i.e. segregation) of securities positions in the context of a court order.

Cross-CSD Impact Analysis

Impact on Investor CSD account configuration

The restriction rules ECDR011 and ECDR012 rely on the usage of MSA(s) defined at securities account level to identify pledge accounts on which certain securities cannot be transferred (also identified with MSA on securities). Investor CSDs of the Estonian CSD servicing those securities would need to have a mechanism in place in their data scope to perform those validations and should consider implementing the MSA at securities account level.

The restriction rule BCDR013 will only be implemented in case Investor CSDs do not service those securities (i.e. it falls outside of the CSD link agreement). In those cases, a securities account parameter is set up with the number of the Investor CSD’s omnibus account, not to be replicated by the Investor CSD. In addition, segregation of securities positions is not required by this business process.

The restriction rule BCDR05 + sub-position “STOP” would not apply on omnibus account of Investor CSDs as it would be their responsibility to handle Court Orders enforced on their participants. Nevertheless, Investor CSDs who have a legal obligation towards indirect participants should consider implementing a similar rule.

Impact on Investor CSD settlement flows

The restriction rules ECDR011 and ECDR012 rely on the usage of MSA(s) defined at securities and securities account level to identify pledge accounts on which certain securities cannot be transferred. Investor CSDs should consider implementing those MSAs and the related restriction rules in order to

comply with this requirement for intra-CSD transactions. Cross-CSD settlement flows would be impacted as follows:

- In case of a cross-CSD transaction between a participant of the Baltic CSDs and a participant of an Investor CSD, where the Baltic CSD participant would be receiving non-pledgeable securities into a pledge account, the Business Instruction sent by the Baltic CSDs would be rejected and the Business Instruction at the Investor CSD level would remain unmatched.
- In other cross-CSD scenarios generating realignments at the Baltic CSDs (i.e. between Investor CSDs' participants or a participant of the Baltic CSDs and a participant of an Investor CSD), realignment instructions would not be impacted and the transaction would be able to settle, as securities accounts of Investor CSDs would not be flagged as pledge accounts.

The restriction rule ECDR013 relies on the usage of MSA(s) defined on securities in order to identify those securities with restricted transferability i.e. having a restriction to pledge and/or a pre-emptive right and accounts on which certain securities cannot be transferred. Investor CSDs must implement this MSA if they wish to service those securities as per requirement of the Estonian / Lithuanian Law.

The restriction rule itself will only be implemented in case Investor CSDs do not service those securities (i.e. it falls outside of the CSD link agreement). As a consequence, it would only be in the case of an erroneous transaction between a participant of an Investor CSD and a participant of the Baltic CSDs that the restriction rule would be triggered at the level of realignment, causing the Business Instructions to be cancelled after matching. This scenario is very unlikely to materialise.

The restriction rule BCDR05 + sub-position "STOP" will not impact trade-related cross-CSD transactions since only the available position ("AWAS") will be used by T2S generated Realignment Settlement Instructions. Furthermore, as this sub-position will not be applicable to Investor CSDs' omnibus accounts, available securities positions will not be impacted. It is only in the case of a cross-CSD transaction where a Baltic CSD participant tries to deliver from the reserved position to a participant of another CSD that the rule would be triggered: the Business Instruction from the Baltic CSD participant would be rejected, while the Investor CSD's participant instruction would remain unmatched.

4.6.2 BOGS

Pre T2S – Process Controls

Capital controls are residency-based measures that a nation's government can use to regulate flows from capital markets into and out of the country's capital account.

Adapted State – Process Controls

Capital control measures have temporarily been enforced in Greece as from July 2015 to counter the outflows of liquidity outside the country. In this context, BOGS has implemented a restriction rule in order to control all receiving settlement instructions free of payment transferring to foreign BOGS' participants, identified by their securities accounts:

- “RT07”, a positive CSD Validation Hold rule, will be defined in order to put on hold all receiving settlement instructions free of payment into some specific BOGS participants’ securities accounts

The parameters configured in the rules are listed below:

- Payment Type Code: FREE
- Securities Movement Type: RECE (receiving leg)
- Instructing Party Type: CSD participant

At this stage, instructions put on hold fulfilling the relevant requirements will be released, other transactions will be cancelled, as defined by the relevant guidelines.

Cross-CSD Impact Analysis

Impact on Investor CSD account configuration

The restriction rule “RT07” does not rely on account configuration parameters and the business process does not require segregation of securities positions. No impact on Investor CSDs’ account configuration has been identified.

Impact on Investor CSD settlement flows

The restriction rule “RT08” would impact Investor CSDs’ settlement flows in the following scenarios:

- In case of a cross-CSD transaction between a participant of BOGS and a participant of an Investor CSD, the Business Instruction sent by the BOGS’ participant matching the rule parameters will be put on CSD Validation Hold and the transaction will remain pending for settlement. At this stage, the transaction would potentially need to be cancelled, bilaterally with the involvement of Investor CSD(s).
- In other cross-CSD scenarios generating realignments at BOGS (between Investor CSDs’ participants), the realignment instructions will not be impacted by the rule, as the securities account number of Investor CSDs are excluded, and the transaction can be eligible to settle.

This restriction rule does not need to be implemented by Investor CSDs.

4.6.3 CDCP

Pre T2S – Process Controls

Upon decision of a competent national authority, CDCP must be able to suspend settlement of an ISIN for a specific period. Such suspension from settlement shall not apply to transactions stemming from inheritance claims.

Furthermore, the market’s oversight body (National Bank of Slovakia) may also request to suspend settlement of an ISIN if deemed necessary. In that latter case, no transaction shall fall outside the scope of this suspension.

Adapted State – Process Controls

In order to be able to comply with requests coming from national regulatory authorities or oversight bodies, CDCP plans to implement restriction rules for in order to be able to suspend settlement in an ISIN:

- “RSB1” a negative Case 2 Restriction Type rule, will be defined to block settlement instructions on an ISIN, on request of a competent national authority, with the exception of transactions stemming from inheritance claims, identified with the ISO transaction code “TRAD” and instructed by CDCP
- “RSB2”, a negative Case 2 Restriction Type rule, will be defined to block settlement instructions on an ISIN, on request of the National Bank of Slovakia in its role of oversight body

The parameters used in the context of these rules are:

- Instructing Party: CDCP’s BIC
- Transaction type code: “TRAD”

Cross-CSD Impact Analysis

Impact on Investor CSD account configuration

The restriction rules “RSB1” and “RSB2” do not rely on account configuration parameters and do not involve account segregation, therefore no impact is foreseen on Investor CSDs’ account configuration.

Impact on Investor CSD settlement flows

The restriction rules “RSB1” and “RSB2” will impact any cross-CSD settlement transaction involving realignment movements at CDCP. As a result, no settlement will take place on the ISIN subject to blocking while the restriction rule is active, and an Investor CSD’s Business Settlement Instruction will be matched but “Pending” for settlement.

At this stage, the transaction would potentially need to be cancelled, bilaterally with the involvement of Investor CSD(s).

However, the rules defined by the Issuer CSD will not prevent intra-CSD settlement of trade-related transactions at Investor CSDs. Since these restrictions are applied on request of competent national authorities, it is expected that Investor CSDs will need to implement the restriction rules and apply the blocking in their data scope.

4.6.4 Clearstream Banking Frankfurt

Pre T2S – Process Controls

A security may also be blocked temporarily by CBF in the context of “Kassen Verein Sperren” (restriction on some securities) according to internal rules.

Adapted State – Process Controls

CBF will make use of intraday restriction on securities (Case 2 Restriction Type) to block settlement of an ISIN according to CBF internal blocking rules (*KV Sperren*). According to CBF, the reason for this blocking is rather operational than imposed by regulatory compliance.

Blocking (Restriction case 2)

“Security Blocking” – blocks settlement of a specific ISIN except for instructions sent by CBF or any of the authorised actors (STORNO BIC).

Cross-CSD Impact Analysis

Impact on Investor CSD account configuration

The restriction rule “Security blocking” does not rely on account configuration parameters and does not mandate account segregation at the Issuer CSD, therefore no impact is foreseen on Investor CSDs’ account configuration.

Impact on Investor CSD settlement flows

The restriction rule “Security Blocking” would impact any cross-CSD transaction in the blocked ISIN as settlement would not be possible while the blocking applies (intra-day only).

4.6.5 Depozitarul Central

Pre T2S – Process Controls

Based on regulatory requirements, or upon request from the competent authority, Depozitarul Central controls the acceptance of new settlement instructions on a particular security, or securities account by maintaining an attribute to indicate the status of the security or securities account. Acceptance of new incoming instructions is only allowed in case that the status assigned to the security, or securities account is not suspended.

Adapted State – Process Controls

In order to stop acceptance of new incoming settlement instructions on a specific security, or securities account, Depozitarul Central has defined the following restriction rules: RT02DC and RT03DC are positive rejection rules (Case 1 Restriction Type) defined in order to reject settlement instructions sent by CSD participants on suspended securities accounts or securities. MSAs are used to define the eligibility status of securities accounts (Account status) and securities (Security status) defined in Depozitarul Central.

While acceptance of new incoming instructions on suspended securities or securities accounts sent by CSD participants is prevented by the restriction rules RT02DC, RT03DC, settlement of pending transactions received in T2S prior to the suspension are allowed.

Rejection (Case 1 Restriction Type)

“RT02DC” - rejects settlement instructions by CSD participants on securities with status “Suspended”.

The parameters configured in the rule are listed below:

- Security status (MSA on securities):
 - Suspended
- Party type of the instructing party:
 - CSD Participant

“RT03DC” - rejects settlement instructions by CSD participants on securities accounts with status “Suspended”.

The parameters configured in the rule are listed below:

- Account status (MSA on securities accounts):
 - Suspended
- Party type of the instructing party:
 - CSD Participant

Cross-CSD Impact Analysis

Impact on Investor CSD account configuration

The restriction rules “RT02DC” and “RT03DC” do not rely on account configuration parameters and the business process does not require segregation of securities positions. No impact on the Investor CSDs’ account configuration has been identified. However, in case a participant is also participant in an Investor CSD, the blocking of its securities account(s) may also be required in the Investor CSD.

Impact on Investor CSD settlement flows

Depozitarul Central’s restriction rule “RT02DC” (suspension of a security) would impact Investor CSDs’ settlement flows in the following scenarios:

- In case of a cross-CSD transaction between a participant of Depozitarul Central and a participant of an Investor CSD on a suspended security, the Business Instruction sent by the participant of Depozitarul Central will be rejected and the Business Instruction at the Investor CSD level will remain unmatched.
- In other cross-CSD scenarios generating realignments at Depozitarul Central (i.e. between Investor CSDs’ participants or a participant of Depozitarul Central and a participant of an Investor CSD), realignment instructions on suspended securities will not be generated and the Business Instructions would be cancelled after acceptance and matching.

Depozitarul Central’s restriction rule “RT03DC” (suspension of a securities account) would impact Investor CSDs’ settlement flows in the following scenarios:

- In case of a cross-CSD transaction between a participant of Depozitarul Central and a participant of an Investor CSD, if the participant account included in the Business Instruction sent by the Depozitarul Central participant is suspended, the Business Instruction will be rejected and the Business Instruction at the Investor CSD level will remain unmatched.

- In case of a cross-CSD transaction generating realignments at Depozitarul Central (between Investor CSDs' participants or a participant of Depozitarul Central and a participant of an Investor CSD), realignment instructions on suspended omnibus accounts owned by the Investor CSD at Depozitarul Central will not be generated and the Business Instructions will be cancelled after acceptance and matching.

The need for Investor CSDs to implement the rules defined by Depozitarul Central would depend on the scope of the regulatory requirement, i.e. whether it has to apply outside the Issuer CSD jurisdiction, and would have to be assessed on a case-by case basis. Indeed, intra-CSD transactions at an Investor CSD on a security, or securities account suspended at Depozitarul Central would not be prevented by the rules.

4.6.6 Euroclear Finland

Pre T2S – Process Controls

Based on regulatory requirements, or upon request from the competent authority, Euroclear Finland controls the acceptance of new settlement instructions on a particular security, or securities account by maintaining an attribute to indicate the status of the security or securities account. Acceptance of new incoming settlement instructions is conditional to the status assigned to the security, or securities account. In addition to those controls applied at validation level, Euroclear Finland also performs blocking of securities accounts in order to prevent settlement of the transactions involving the blocked account that are already in the system.

Adapted State – Process Controls

Euroclear Finland plans to define the following restriction rules in the context of other regulatory compliance:

Rejection (Case 1 Restriction Type):

“ASTS (A)”: rejects all delivering settlement instructions on securities accounts with status "Suspended" (identified with MSA).

The parameters configured in the rule are listed below:

- “ACCOUNTSTATUS” (MSA on securities accounts configured as “Debit”), with value:
 - Suspended
- Securities Movement Type:
 - DELI

“ASTS (B)”: rejects all settlement instructions on securities accounts with status “Frozen” (identified with MSA).

The parameter configured in the rule is listed below:

- “ACCOUNTSTATUS” (MSA on securities accounts), with value:
 - Frozen

“ISEV”: rejects all settlement instructions on securities accounts with status “Y” (identified with MSA).

The parameter configured in the rule is listed below:

- “PARTYHOLD” (MSA on securities accounts), with value:
 - Y

“ISUS”: rejects all settlement instructions on an ISIN with status “Suspended” or “To be Deleted” (identified with MSA).

The parameter configured in the rule is listed below:

- “INSTRUMENT STATUS” (MSA on securities), with values:
 - Suspended
 - To be Deleted

“WATI”: rejects all settlement instructions sent by CSD Participants on accounts undergoing whole account transfer (identified with MSA).

The parameters configured in the rule are listed below:

- “CSDFROZEN” (MSA on securities accounts), with value:
 - Y
- Party Type (of the instructing party), with value:
 - CSD Participant

Blocking (Case 2 Restriction Type):

“ACDR”: blocks all settlement instructions debiting a specific securities account, unless sent to T2S with the “CORP” ISO transaction code, or debiting the “COSP” or “EEUR” securities positions used by T2S for Conditional Securities Delivery and auto-collateralisation respectively.

The parameters configured in the rule are listed below:

- Securities Movement Type, with value:
 - DELI
- Transaction Identification (ISO transaction code), with value:
 - CORP
- Credited/Debited Position/Balance, with values:
 - COSP
 - EEUR

“ACCR”: blocks all settlement instructions on a specific securities account, unless sent to T2S with the “CORP” ISO transaction code, or debiting/crediting the “COSP” or “EEUR” securities positions used by T2S for Conditional Securities Delivery and auto-collateralisation respectively.

The parameters configured in the rule are listed below:

- Transaction Identification (ISO transaction code), with value:
 - CORP
- Credited/Debited Position/Balance, with values:
 - COSP
 - EEUR

Cross-CSD Impact Analysis

Impact on Investor CSD account configuration

The restriction rules “ASTS (A)”, “ASTS (B)”, and “ISEV” rely on the usage of an MSA defined at securities account level. In case the participant subject to those restrictions is also participant in an Investor CSD, the restriction of its securities account(s) may also be required in the Investor CSD.

The restriction rule “WATI” relies also on the usage of an MSA defined at securities account level. However, no impact on Investor CSDs’ account configuration has been identified since the securities accounts subject to rejection are not held by Investor CSDs.

The restriction rule “ISUS” does not rely on account configuration parameters and the business process does not require segregation of securities positions. No impact on Investor CSDs’ account configuration has been identified.

The restriction rules “ACDR” and “ACCR” are applied on account level, but do not rely on the usage of MSA and the business process does not require segregation of securities positions. In principle, no impact on Investor CSDs’ account configuration has been identified. However, in case the restricted participant is also participant in an Investor CSD, the blocking of its securities account(s) may also be required in the Investor CSD.

Impact on Investor CSD settlement flows

Euroclear Finland’s restriction rules “ASTS (A)”, “ASTS (B)”, and “ISEV” (suspension of a securities account) would impact Investor CSDs’ settlement flows in the following scenarios:

- In case of a cross-CSD transaction between a participant of Euroclear Finland and a participant of an Investor CSD, where the participant account included in the Business Instruction sent by the Euroclear Finland participant is restricted, the Business Instruction will be rejected and the Business Instruction at the Investor CSD level will remain unmatched. No realignment will be triggered for this transaction.
- In other cross-CSD scenarios triggering realignment at Euroclear Finland on a restricted omnibus account, realignment instructions will not be generated and the Business Instructions will be cancelled after acceptance and matching.

Euroclear Finland’ restriction rule “ISUS” (suspension of an ISIN) would impact Investor CSDs’ settlement flows in the following scenarios:

- In case of a cross-CSD transaction between a participant of Euroclear Finland and a participant of an Investor CSD on a non-eligible security (i.e. status different than “Suspended” or “To be Deleted”), the Business Instruction sent by the participant of Euroclear Finland will be rejected and the Business Instruction at the Investor CSD level will remain unmatched. No realignment will be triggered for this transaction.
- In other cross-CSD scenarios triggering realignment at Euroclear Finland on non-eligible securities (i.e. status different than “Suspended” or “To be Deleted”), realignment instructions will not be generated and the Business Instructions will be cancelled after acceptance and matching.

The need for Investor CSDs to implement the above rules defined by Euroclear Finland would depend on the scope of the regulatory requirement, i.e. whether it has to apply outside the Issuer CSD jurisdiction, and would have to be assessed on a case-by case basis. Indeed, intra-CSD transactions at an Investor CSD on a security, or securities account suspended at Euroclear Finland would not be prevented by the rules.

The rule “WATI” does not need to be replicated by Investor CSDs, as none of the securities accounts triggering the rejection are available to Investor CSDs:

- In case of a cross-CSD transaction between a participant of Euroclear Finland whose Business Instruction is matching the rule parameters and a participant of an Investor CSD, the Business Instruction of the Euroclear Finland participant will be rejected while the Business Instruction of the Investor CSD will remain unmatched. No realignment will be triggered for this transaction.
- In other cross-CSD scenarios triggering realignment at Euroclear Finland, the realignment instructions will not be impacted by the rule and the transaction can be eligible to settle.

For cross-CSD transactions, Euroclear Finland’s restriction rules “ACDR” and “ACCR” would have an impact on the Investor CSD settlement flows in case the securities account blocked for settlement is:

- An omnibus account of an Investor CSD at Euroclear Finland or,
- An account of a participant of Euroclear Finland involved in a cross-CSD transaction.

Settlement instructions against the blocked account would not be eligible for settlement and consequently, settlement of the whole realignment chain would be pending while the blocking applies.

The need for Investor CSDs to implement the “ACDR” and “ACCR” restriction rules defined by Euroclear Finland would depend on the scope of the regulatory requirement, i.e. whether it has to apply outside the Issuer CSD jurisdiction, and would have to be assessed on a case-by case basis. Indeed, intra-CSD transactions at an Investor CSD involving a participant for whom the securities account is blocked at Euroclear Finland would not be prevented by these rules.

4.6.7 Interbolsa

Pre T2S – Process Controls

Interbolsa has defined a specific securities situation called “judicial blocking”. It is a tool given by Interbolsa to its participants to block securities in the system to avoid them to be used for settlement, when e.g. a court order has been enforced against the beneficial owner of the securities (“*010 Bloqueio judicial*”).

Adapted State – Process Controls

Interbolsa has defined a position type (“BL10”) for blocking securities positions (Case 3 Restriction Type) in the context of judicial blocking, as well as a restriction rule to prevent the debit of this sub-position.

Blocking (Restriction case 3)

“BL10” - Blocks securities position (judicial blocking)

Rejection (Restriction case 1)

“SR03” - rejects settlement instructions sent by CSD participants debiting securities positions created in the context of judicial blocking.

The parameters configured in the rule are listed below:

- Party type of the instructing party:
 - CSD participant
- Debited position:
 - “BL10” – (judicial blocking)

Note that at any time the blocked position can be debited by the CSD participant thanks to a settlement restriction.

Cross-CSD Impact Analysis

Impact on Investor CSD account configuration

The restriction “BL10” is defined to allow participants of Interbolsa to block securities into a specific position type, in the context of judicial blocking.

Investor CSDs could also use this functionality to block specific securities positions in an Investor CSD’s omnibus account, and in this case, Investor CSDs opting for this segregation have to implement adequate segregation in their books (by position types or separate accounts).

Impact on Investor CSD settlement flows

Interbolsa’s restriction rules related to judicial blocking will not have a direct impact on trade-related cross-border instructions, as realignment instructions would not make use of the restricted positions; i.e. realignment instructions would not match the restriction rules. Investor CSDs opting for this segregation have to implement adequate segregation in their books (by position types or separate accounts) in order to ensure consistency of available securities position (AWAS) between omnibus and participants’ accounts and prevent the risk of settlement fail at the level of the omnibus account provision check.

4.6.8 KDD

Pre T2S – Process Controls

KDD performs blocking of securities account upon request by the competent authority preventing settlement of any transaction on the blocked account.

Adapted State – Process Controls

KDD plans to define “C203”, a negative blocking (Case 2 Restriction Type) rule, for blocking securities accounts upon request of the competent authority.

Blocking (Case 2 Restriction Type):

“C203” – blocks settlement on a given securities account upon request of the competent authority, except for settlement instructions sent by KDD.

Cross-CSD Impact Analysis

Impact on Investor CSD account configuration

The restriction rule does not rely on account configuration parameters and does not involve account segregation. Therefore, no impact is foreseen on the Investor CSDs' account configuration.

Impact on Investor CSD settlement flows

For cross-CSD transactions, KDD restriction rule "C203" related to regulatory compliance could have an impact on the Investor CSD settlement flows in case that the securities account blocked for settlement is:

- an omnibus account of an Investor CSD at KDD or,
- an account of a participant of KDD involved in a cross-CSD transaction.

Settlement instructions against the blocked account would not be eligible for settlement and consequently, settlement of the whole realignment chain would be pending while the blocking applies.

However, intra-CSD transactions at an Investor CSD, involving a participant for whom the security account is blocked at KDD, would not be prevented by this rule. Therefore, if the participant for whom the securities account is blocked at KDD is as well a participant of the Investor CSD, the rule may also have to be implemented by the Investor CSD when needed for compliance with regulatory requirements.

4.6.9 Monte Titoli

Pre T2S – Process Controls

When there is a dividend payment postponement option in Monte Titoli, the securities on which the postponement option has been chosen are issued into an interim ISIN. The interim ISINs cannot be transferred against payment but only free of payment under the direct responsibility of intermediaries.

Investors normally exercise dividend postponement options because of the tax benefits they may derive from postponing the dividend payment to the next fiscal year. On the contrary, according to Monte Titoli, dividend postponement is normally not chosen by Investor CSDs as they are not interested in registering in their balances such securities. Consequently, interim securities are rarely transferred cross-border.

Adapted State – Process Controls

Monte Titoli will setup a restriction rule in order to reject (Case 1 Restriction Type) against payment instructions on interim ISINs. Interim ISINs will be defined in the T2S static data with an MSA on securities (Securities Transfer Mode).

Rejection (Case 1 Restriction Type)

"RVP1" - This restriction rule is used in the context of regulatory compliance checking the consistency between the following rule parameters:

- Security
- Securities Transfer Mode (Market specific attribute on securities)

Cross-CSD Impact Analysis

Impact on Investor CSD account configuration

The restriction rule “RVP1” is set at the level of the security. The restriction rule does not rely on account configuration parameters and the business process does not require segregation of securities positions. No impact on Investor CSDs’ account configuration has been identified.

Impact on Investor CSD settlement flows

The restriction rule “RVP1” will reject any settlement instruction against payment (DVP) on an interim ISIN:

- In case of a DVP cross-CSD transaction on a security, defined as Interim ISIN, between a participant of Monte Titoli and a participant of an Investor CSD, the Business Instruction in Monte Titoli would be rejected while the Business Instruction in the Investor CSD would remain unmatched.
- In case of a DVP cross-CSD transaction on a security, defined as Interim ISIN, between Investor CSDs’ participants generating realignment movements at Monte Titoli, the realignment instructions on the interim ISIN that would be generated for cross-CSD settlement would not match the rejection rule, as realignment instructions are free of payment.

The need for Investor CSDs to implement the restriction rule “RVP1” defined by Monte Titoli would depend on whether this postponement of dividend would be an option supported by their participants. If this is the case, Investor CSDs should implement the rule to prevent intra-CSD transactions on such Interim ISINs.

Conclusion

CSDs define controls in the form of restriction rules to comply with regulatory requirements in place in their national jurisdiction, internal rules, or, in some other cases, to provide tools to their participants to control settlement activity of their clients.

The Baltic CSDs (Estonian and Lithuania CSDs only) plan to implement restriction rules in order to deal with restrictions related to non-public companies such as pre-emptive right for existing shareholders and interdiction to pledge securities. This stems from the fact that by Law, certain types of companies must register their securities in the CSD, regardless of the fact whether those companies are listed or traded publicly. In addition, the Baltic CSDs have also defined restriction rules to block securities in a specific sub-position in order to enforce a Court Order against a client of a CSD participant.

BOGS has implemented restriction rules for capital control measures that have temporarily been enforced in Greece as from July 2015 to counter the outflows of liquidity outside the country. These may impact Investor CSDs settlement flows but obviously do not need to be replicated.

CDCP has implemented restriction rules in order to suspend settlement of securities upon request of relevant national regulatory bodies. In certain cases, transactions stemming from inheritance

claims shall be exempted from this suspension. Investor CSDs of CDCP would need to implement the same controls in their data scope.

In the case of Depozitarul Central and Euroclear Finland, restriction rules will be put in place for regulatory reasons, not related to insolvency, in order to reject settlement instructions on a restricted securities or a securities account. In addition to those controls applied at validation level, Euroclear Finland will also perform blocking of securities accounts in order to prevent settlement of the transactions involving the blocked account that are already in the system. The need for Investor CSDs to implement these controls in their structure would depend on the scope of the requirements, i.e. whether it applies outside of the Issuer CSD's jurisdiction.

KDD plans to implement a restriction rule in order to suspend settlement on a given securities account upon request of the competent authority. Investor CSDs of KDD may also have to implement the same control in their data scope when the participant for whom the securities account is blocked at KDD is as well a participant of the Investor CSD.

In the case of Monte Titoli, if an Investor CSD allows the postponement of dividend for its participants, it will have to implement the restriction rule put in place in Monte Titoli in order to comply with requirements in place in the Italian market.

In Clearstream and Interbolsa, restriction rules are put in place in order to support CSD participants (and specifically Investor CSDs in the case of Clearstream) with appropriate tools to control settlement in the context of regulatory requirements. If Investor CSDs use these tools, they should also implement appropriate controls in their own structure.

In addition, Clearstream has also implemented an intraday restriction to temporarily block settlement on specific securities (KV Sperren) according to internal rules. Such control does not need to be implemented by Investor CSDs.

4.7 External Cash Settlement

Introduction

For the assessment of restriction rules according to the methodology defined in Section 2.2 “Methodology to quantify impacts on Investor CSDs”, External Cash Settlement is categorised as an optional service from an Investor CSD’s standpoint, as it is not necessary for carrying out Investor CSD activity.

The settlement of a securities transaction involving a currency not eligible for settlement in T2S requires settlement of the cash leg outside T2S. In such case, the security leg can be conditionally settled in T2S upon successful settlement of the cash leg via the Conditional Securities Delivery (CoSD) functionality.

More generally, the CoSD functionality can be used whenever the settlement of a transaction requires fulfilment of conditions external to T2S, and securities or cash resources need to be reserved until the condition is met.

T2S is designed as a multi-currency securities settlement platform in Central Bank Money, and provides the possibility to settle securities against payment (DVP) as well as Free-Of-Payment (FOP)⁹⁴. For the initial release of T2S however, Euro will be the only eligible settlement currency. The Danish Krone will become eligible in 2018.

Prior to T2S, some CSDs offer settlement services in multiple currencies. These vary in scope: currencies offered, money quality (Central Bank Money versus Commercial Bank Money), possible trade counterparties (Intra-issuer CSD settlement or external CSD settlement when acting as Investor CSD), FX rate conversion, etc...

The requirements for CSD participants to benefit from settlement services in multiple currencies depend on the link arrangements of CSDs as well as the banking services they provide. A few CSDs are authorised to hold cash accounts for their participants (reflected in their balance sheet), but the majority of CSDs rely on external agent banks or payment systems to offer such services.

In T2S, business validation rules have been put in place to prevent DVP in an ineligible settlement currency (instructions are rejected at business validation level). As for the denomination currency of a security, T2S does not impose any specific validation besides the compliance to (ISO4217) currency code standards. Consequently, securities accepted in T2S for settlement can be denominated in all valid currencies.

Settlement of the cash leg outside T2S is mandatory in case the currency is not eligible for settlement in T2S, as well as for transactions which do not involve Central Bank Money settlement⁹⁵.

⁹⁴ Other instruction types have been designed in T2S to facilitate handling of inter-alia Corporate Actions payments (PFOD) and instructions submitted by CCPs, “strange nets” (DWP/RWP). See details in UDFS version 2.0, Section “1.2.5 Instruction Types”

⁹⁵ When there are no settlement movements on Dedicated Cash Accounts in T2S

Proposed procedure for handling transactions involving cash settlement outside T2S

The following (non-mandatory) procedure has been defined among T2S actors to handle transactions involving cash settlement outside T2S:

- The instructions must be submitted to T2S as FOP⁹⁶, but including all relevant cash information details (amount and currency, credit/debit indicator, and optionally cash account and cash parties)
- T2S will not consider the cash information for matching the instructions: amount, currency, credit/debit indicator
- A “Conditional Securities Delivery” (CoSD) will be set up:
 - This will ensure that the securities in the FOP instructions are blocked until cash settlement is performed outside T2S. Once settlement of the cash leg has taken place, the instructions will be released by the Administering Party (which must be a T2S Actor, but not necessarily the CSD) so that securities settlement can take place in T2S.
- T2S will provide a settlement confirmation for the FOP instructions with zero as settled amount, the confirmation of cash settlement will be provided by the external cash settlement entity

If necessary, other CSD specific rules may be put in place to perform additional validations before the Intended Settlement Date, e.g.: CSD Validation Hold is an automatic setting on hold during the T2S business validation process which is performed as soon as the instructions are received. CSD Validation Hold does not prevent the matching process to take place. It may be used by CSDs for additional validation and verification, e.g. validation of cash details in the counterparty’s matched FOP instructions, verification of business validation rules set up outside T2S (for instructions sent by DCPs), such as the existence of an external cash account for the trade counterparties. Once validated, the instructions will be released by the CSD.

The description of current services and controls, restrictions and CoSD rules, and impact analysis by market is detailed in the next sections.

4.7.1 Baltic CSDs

Pre T2S – Process Controls

The Latvian CSD (LCSD) provides settlement services in non-Euro currencies in Commercial Bank Money through cash correspondent banks. For DVP settlement in USD currency LCSD has opened a correspondent cash accounts with Deutsche Bank Trust Company Americas, for DVP settlement in RUB currency LCSD has opened a cash account with Rietumu Banka JSC.

In order to benefit from DVP settlement in a foreign currency, CSD participants shall provide LCSD with their foreign currency account details.

⁹⁶ Payment type code = “FREE”

On intended settlement date, sufficient cash provision must be transferred to the LCSD correspondent cash account before the start of the settlement process. Once the account has been credited with the cash, LCSD receives a confirmation of the credited amount from the correspondent bank. If the received value of cash is sufficient to settle monetary obligations for the transactions, LCSD starts the settlement process.

Calculations of cash and securities net positions are made separately for each currency.

Adapted State – Process Controls

LCSD will continue to provide DVP settlement services in USD (i.e. not an eligible settlement currency in T2S) with the securities leg of the transaction being settled in T2S. The service will not be available to Investor CSDs (which are defined as internal CSDs in T2S), and therefore will be restricted to intra-CSD transactions. For this purpose, no restriction rules will be set up; however a CoSD rule “LCSD_CoSD” will be defined for FoP transactions instructed in the accepted currency (USD), to temporarily block the securities delivery in T2S until cash settlement is confirmed in the external correspondent bank. The parameters configured in this CoSD rule are listed below:

- Settlement currency: USD
- Securities movement type: DELI
- Payment Type Code: FREE
- BIC of receiving CSD: LCSD

Impact on Investor CSD account configuration

The CoSD rule implemented by LCSD does not rely on account configuration parameters, and no segregation or static data configuration (MSA) is foreseen at account level in T2S for the provision of this service, as related business validations (i.e. the availability of a cash account in USD) will be managed outside T2S. Furthermore, settlement in USD will not be available to Investor CSDs and therefore no impact is foreseen in terms of account configuration.

Impact on Investor CSD settlement flows

The CoSD rule “LCSD_CoSD” put in place by LCSD does not need to be implemented by Investor CSDs. Indeed, the service will not be available to Investor CSDs of LCSD, and hence any cross-CSD transaction in a currency not eligible for settlement in T2S would be the result of erroneous instructions. In this hypothetical case, the CoSD rule will not be triggered for transactions involving an Investor CSD of LCSD in T2S, or transactions that include a currency that is not in the scope of the service. Such transactions would settle as FOP. In the case of a transaction between participants of Investor CSDs so that only the realignment takes place in LCSD, the rule will not affect the realignment instructions, since realignment instructions do not include the currency field.

4.7.2 BOGS

Pre T2S – Process Controls

Bank of Greece (BoG) provides the services of a Payment bank to some specific domestic participants: brokers with no access to TARGET2, the issuer of the Greek Government Securities (e.g. the Ministry of Finance), social securities and pension funds. These participants are allowed to use the TARGET2 accounts opened by Bank of Greece, under the condition that the required funds are available upfront in the respective cash balances held at the internal system of BoG, as BoG cannot provide credit facilities to these participants (via auto-collateralisation). The current process foresees that the checks on the cash side are executed when the relevant securities are available. For this purpose, Bank of Greece Securities Settlement Systems (BOGS) blocks the securities on the deliverer's securities account first, calculates the net cash requirements to settle the transaction(s), and transmits this information to BoG. Based on this information, BoG checks the cash balance, and ensures that the funds are made available in the relevant RTGS account in TARGET2. The transactions are then released for settlement.

Adapted State – Process Controls

Note: The process described below is a conditional settlement where both the securities and the cash legs settle in T2S based on funds availability in the internal systems of BoG

BoG will continue to provide Payment Bank services to these specific domestic participants by allowing liquidity flows via BoG's DCAs that will be opened by BoG in T2S for this purpose. The service will be implemented according to the same logic as before T2S: as T2S DCAs will be shared by many of the participants (e.g. brokers), the process cannot rely on the cash balance available on a T2S DCA. Based on net cash requirements for a set of transactions (which e.g. the broker will have linked together via pool references), BoG will check the available cash balance of the participant in its internal systems and will ensure that a liquidity transfer is made to the relevant DCA. For the purpose of the service, BOGS will create a restriction rule, as well as a positive CoSD rule:

- “RT03”, a positive CSD Validation Hold rule, will be defined to put on hold receiving settlement instructions against payment on securities accounts linked to the DCAs created for this service. The instructions triggering the rule will be put on hold as soon as received in T2S at the time of business validation.
- “RT04”, a CoSD hold rule, will be triggered on the Intended Settlement Date (ISD), based on the conditions defined for the restriction rule above with the addition that the ISO transaction code “TRAD” is filled in the instruction. The rule will block securities on the deliverer's securities account while checking the cash balance of the respective party using BoG as Payment Bank.

The parameters configured in the rules are defined as below:

- Payment type code: APMT (against payment)
- Securities Movement Type: RECE (receiving leg)
- Transaction identification: TRAD (trade transaction type)
- Securities Account number: list of account numbers of the participants subscribing to this service

The rationale for defining a CSD Validation Hold rule on top of the CoSD is that BOGS needs to perform some additional checks for specific transactions and may need to cancel it. In particular in the case of issuance of securities, the check would not be appropriate through CoSD due to the usage of the linking functionality.

Once the liquidity transfer is made by BoG in the relevant DCA, the instruction(s) on CoSD Hold will be released for settlement.

The setup of a secondary Cash Memorandum Balance (CMB) with an external guarantee limit, defined based on the available balance of the participant in the internal system of BoG, and no auto-collateralisation limit, would alleviate the need for this conditional process. BoG has investigated this possibility and ruled it out due to legal constraints.

Cross-CSD Impact Analysis

Impact on Investor CSD account configuration

The CoSD rules “RT03” and “RT04” do not rely on account configuration parameters and the business process does not require segregation of securities positions. Besides, the service will not be available to Investor CSDs of BOGS in T2S. Therefore, no impact is foreseen on Investor CSDs’ account configuration.

Impact on Investor CSD settlement flows

The CoSD rules “RT03” and “RT04” do not need to be replicated by Investor CSDs.

Indeed, the service is only available to certain categories of domestic participants who have no cross-CSD activity. The volume of transactions of these participants is also very limited, averaging less than 10 per day. The rule configuration only allows the blocking of securities based on certain securities accounts when BOGS is both the delivering and receiving CSD, so that the rule will not get triggered in cross-CSD scenarios. It is to be noted that BOGS currently has only one link as Investor CSD with Clearstream Banking Frankfurt and that this link is FOP. BOGS will reconsider the implementation of this rule if CSD participants using this service (brokers, Ministry of Finance and Security Funds) have cross-CSD activity or if new CSD links are put in place.

In the hypothetical case of a cross-CSD transaction with one of the above BOGS participants buying securities from a participant of another CSD, the Business Instruction in BOGS will be put on CSD Validation Hold and the transaction will remain pending for settlement. At this stage, BOGS will cancel the Business Instruction of its participant, and a cancellation allegation will be sent to the Investor CSD to cancel its Business Instruction, as T2S requires bilateral cancellation of the transaction once instructions have been matched. In the case where BOGS would instead release the instruction, the transaction will not be put on CoSD Hold and may be eligible for settlement. In the case of a transaction between participants of Investor CSDs so that only the realignment takes place in BOGS, the rules will not be triggered (as the securities account number of Investor CSDs are excluded).

4.7.3 Clearstream Banking Frankfurt (CBF)

Pre T2S – Process Controls

Clearstream Banking Frankfurt (CBF) provides settlement services in 20 currencies in Commercial Bank Money via Creation, the settlement platform of Clearstream Banking Luxembourg (CBL). The service is provided for the settlement of securities admitted in Collective Safe Custody (CSC)⁹⁷ where CBF acts as Issuer or Investor CSD. For this purpose, CBF participants hold 6-series accounts, which are CBF accounts governed by German Law, but technically managed in CBL. For the settlement of CSC securities in a non-Euro currency, the seller's securities are first blocked until cash settlement is performed in Creation (CBL's settlement platform), then in a second step, the blocking is released and settlement of the security leg takes place in CBF. In addition, CBF provides settlement in CHF in Central Bank Money via the Swiss National Bank. CBF participants must have an account in the Swiss National Bank to benefit from this service. Business validation rules are put in place in CBF to ensure correct usage of both services. Non-Euro currency settlement services are not available to Investor CSDs.

Adapted State – Process Controls

Clearstream (CBF) will continue to provide settlement services in multiple currencies ineligible for settlement in T2S, via its sister company in Luxembourg (CBL) and the Swiss National Bank. The service will be available upon subscription to ICPs and DCPs of CBF, but not to Investor CSDs (which are defined as internal CSDs in T2S). ICPs will have to instruct a DVP to CBF (CBF will perform the conversion and send FOP instructions with cash details to T2S), while DCPs will have to send FOP instructions with cash details to T2S, as described in the procedure in the “Introduction” section. CBF recommends using the optional matching field “Common Trade Reference” in the settlement instructions⁹⁸. The “Common Trade Reference” will be populated by CBF for instructions received by ICPs. The following restriction rules are planned for the provision of non-Euro currency settlement services:

- “Foreign Currency Settlement - Rejection”, a positive rejection (Case 1 Restriction Type) rule. The rule will be set up to reject FOP instructions that include a currency which is not eligible for settlement by CBF
- “Foreign Currency Settlement – CVAL”, a positive “CSD Validation Hold” (Case 1 Restriction Type) rule. The rule will be set up to hold FOP instructions that include a currency eligible for non-Euro currency settlement by CBF. This will allow CBF to verify the cash details in the matched FOP instructions

⁹⁷ CBF also provides the possibility to its participants to trade in Non-Collective Safe Custody (NCSC) securities, where both securities and cash legs are settled on CBL's platform, regardless of the settlement currency

⁹⁸ Cash details are not taken into account for matching by T2S in the case of FOP instructions, therefore populating the “Common Trade Reference” may help reducing risks of mismatching. The topic is addressed through the CR T2S-0526-URD in order to consider cash details as additional matching fields in FOP instructions.

In addition, a CoSD rule will be triggered on the Intended Settlement Date to temporarily block the securities delivery while cash settlement is performed on CBL's platform. The rule will hold all FOP deliveries in the accepted non-T2S settlement currencies according to the following parameters:

- Currencies: List of eligible currencies
- Securities movement type: DELI
- Payment Type Code: Free

Cross-CSD Impact Analysis

Impact on Investor CSD account configuration

The restriction and CoSD rules implemented by CBF do not rely on account configuration parameters, and no segregation or static data configuration (MSA) is foreseen at account level in T2S for the provision of this service, as related business validations will be managed outside T2S. In any case, the service will not be available to Investor CSDs and no impact is foreseen in terms of account configuration.

Impact on Investor CSD settlement flows

The restriction and CoSD rules put in place by CBF do not need to be implemented by Investor CSDs.

Indeed, the service will not be available to Investor CSDs of CBF in T2S, any cross-CSD transaction in an ineligible T2S settlement currency would be the result of erroneous instructions between a CBF participant and a participant of an Investor CSD or between participants of Investor CSDs directly.

Furthermore, in the case of a transaction between participants of Investor CSDs so that only the realignment takes place in CBF, the rules will not affect the realignment instructions, since realignment instructions do not include the currency field.

Below are the details of the transaction lifecycle in the hypothetical case of erroneous instructions:

- The rule “Foreign Currency Settlement - Rejection” will reject any FOP instruction of a CBF participant on a currency non-eligible for settlement with CBF:
 - In case of a cross-CSD transaction between a participant of CBF acting as DCP and a participant of an Investor CSD, the Business Instruction in CBF will be rejected while the Business Instruction in the Investor CSD will remain unmatched. No realignment for this transaction will be created.
 - In case of a transaction between Investor CSDs' participants involving realignment movements at CBF, the realignment instructions will not be impacted by the rule.
- The positive rule “Foreign Currency Settlement –CVAL” will hold for CSD Validation any FOP instruction of a CBF participant on a currency eligible for the service with CBF:
 - In case of a cross-CSD transaction between a participant of CBF acting as DCP and a participant of an Investor CSD, the Business Instruction in CBF will be put on CSD

Validation Hold and the transaction will remain pending for settlement. At this stage, CBF will cancel the Business Instruction of its participant, and a cancellation allegation will be sent to the Investor CSD to cancel its Business Instruction, as T2S requires bilateral cancellation of the transaction once instructions have been matched.

- In case of a transaction between Investor CSDs involving realignment movements at CBF, the realignment instructions will not be impacted by the rule
- The CoSD rule will hold FOP delivery instructions of a CBF participant on a currency eligible for the service with CBF, however, in the hypothetical case of erroneous transactions involving Investor CSDs, the settlement flows would be affected as follows:
 - In case of a transaction between a participant of CBF and a participant of an Investor CSD, the Business Instruction of the CBF participant will have been cancelled by CBF at the validation stage, or will still be on “CSD Validation Hold” pending cancellation from the counterparty.
 - In case of a transaction between Investor CSDs involving realignment movements at CBF, the realignment instructions will not be impacted by the rule.

4.7.4 Interbolsa

Pre T2S – Process Controls

Interbolsa provides non-Euro currency settlement services in Commercial Bank Money via the Caixa Geral de Depósitos operating the Non-Euro Payment System (SPME) for the following currencies: USD, GBP, CHF, JPY, AUD, and CAD. The service is provided for the settlement of debt securities issued in non-euro currencies. For this purpose, Interbolsa’s participants must have an account (per currency) either directly or indirectly in the SPME. Settlement in non-Euro currencies is available to Investor CSDs of Interbolsa provided they fulfil this requirement. For transactions involving settlement in a non-Euro currency, the securities are first blocked into the seller’s account until cash settlement is performed in the external payment system. Business validation rules are put in place in Interbolsa for settlement in non-Euro currency, to check that the currency is accepted by Interbolsa, as well as to verify the existence of the corresponding account at SPME.

Adapted State – Process Controls

Interbolsa will continue to provide settlement services in multiple currencies ineligible for settlement in T2S, via the Non-Euro Payment System (SPME) platform. The service will be available upon subscription, for ICPs and DCPs of Interbolsa, but not for Investor CSDs (defined as internal CSDs in T2S). For this purpose, no restriction rules will be set up; however a CoSD rule “CRS01” will be defined for intra-CSD transactions for currencies accepted by Interbolsa, to temporarily block the securities delivery while cash settlement is performed on the SPME. The parameters configured in the rules are listed below:

- Currencies: List of eligible currencies
- Securities movement type: DELI
- Payment type code: Free
- CSD: Interbolsa BIC - CSD owning the delivering or receiving securities account in the settlement instruction
- Place of Settlement: Interbolsa's BIC - CSD of the counterparty defined in the settlement instruction

The parameters "CSD" and "Place of Settlement" are used to restrict the scope of CoSD rule to intra-CSD transactions⁹⁹.

If instructions are mismatched, or do not fulfil the Business Validation rules set up outside T2S, or cash settlement fails, these will be cancelled by Interbolsa (and securities will be unblocked automatically by T2S). No Market-Specific Attribute will be used for the set-up of the rule.

Cross-CSD Impact Analysis

Impact on Investor CSD account configuration

The CoSD rule "CSR01" implemented by Interbolsa does not rely on account configuration parameters, and no segregation or static data configuration (MSA) is foreseen at account level in T2S for the provision of this service, as related business validations will be managed outside T2S. In any case, the service will not be available to Investor CSDs and no impact is foreseen in terms of account configuration.

Impact on Investor CSD settlement flows

The CoSD rule "CSR01" put in place by Interbolsa does not need to be implemented by Investor CSDs.

Indeed, the service will not be available to Investor CSDs of Interbolsa in T2S, any cross-CSD transaction in an ineligible T2S settlement currency would result from erroneous instructions. At the time of writing, this limitation impacts the scope of the instruments that Investor CSDs are able to hold in Interbolsa, for those securities (not denominated in Euro) for which the Issuer pays CA proceeds in non-Euro.

The rule will not impact investor CSD settlement flows: it is defined for ICPs and DCPs of Interbolsa, for intra-Issuer CSD transactions only, due to the rules parameters ("CSD" and "Place of Settlement"). The CoSD rule will not be triggered for transactions involving an Investor CSD of Interbolsa in T2S, or transactions that include a currency that is not in the scope of the service. Such transactions would settle as FOP. In the case of a transaction between participants of Investor CSDs so that only the realignment takes place in Interbolsa, the rule will not affect the realignment instructions, since realignment instructions do not include the currency field.

⁹⁹ Further information can be found in the UDFS 2.0: "TABLE 11 – COSD PARAMETER TYPES"

4.7.5 KELER

Pre T2S – Process Controls

KELER provides settlement services in Commercial Bank Money in 45 currencies, including Euro, for Over-The-Counter (OTC) trades¹⁰⁰ via links it maintains with e.g., CBL, SIX-SIS, and Citibank. To benefit from this service, KELER participants must hold a cash account enabled per currency in KELER¹⁰¹. The service is provided for the settlement of domestic as well as foreign securities and is available to Investor CSDs. As such, there is no specific process put in place for settlement of foreign currencies, but securities (or cash) are reserved in the case of DVP (resp. RVP) transactions where KELER acts as Investor CSD, and debited upon settlement confirmation from the Issuer CSD, according to common market practices. Business validation rules are put in place in KELER to ensure correct usage of the service.

Adapted State – Process Controls

KELER will continue to provide settlement services in multiple currencies in Commercial Bank Money after migration to T2S, to ICPs and DCPs, as well as to Investor CSDs (defined as internal CSDs in T2S). The service will be provided in T2S for transactions in non-Euro currencies (among which Hungarian Forint), where the securities leg of the transaction settles in T2S. For this purpose, a CoSD rule, “RT08_External_Cash”, will be defined to temporarily block the securities delivery while cash settlement is performed in KELER or at the Hungarian National Bank (for settlement in HUF). The rule parameters configured in the rule are listed below:

- Currencies: list of eligible currencies for external cash settlement
- Payment type code: Free
- Securities Movement Type: DELI (delivering settlement instructions)

No Market-Specific Attribute is currently foreseen for the provision of this service.

Cross-CSD Impact Analysis

Impact on Investor CSD account configuration

No segregation or static data configuration (MSA) is foreseen by KELER at account level in T2S for the provision of settlement in ineligible T2S settlement currencies, related business validations will be managed outside T2S. Investor CSDs wishing to benefit from this service only need to open a dedicated account with KELER for HUF settlement.

Impact on Investor CSD settlement flows

¹⁰⁰ For Stock Exchange trades, transactions can settle in EUR in Commercial Bank Money or in HUF in Central Bank Money

¹⁰¹ KELER has a limited banking license and is holding cash accounts for its participants

Investor CSDs of KELER wishing to use the services provided by KELER for External Cash Settlement would need to implement the CoSD rule implemented by KELER in their data scope. Indeed, the CoSD rule “RT08_External_Cash” will only put on CoSD Hold those instructions in specific cross-CSD scenarios where the participant of KELER is delivering securities matching the rule parameters and subject to cash settlement in HUF¹⁰². In such case, if instructions on CoSD Hold are mismatched, or do not fulfil the Business Validation rules set up outside T2S, or cash settlement fails, one leg will be cancelled by KELER while the other leg will have to be cancelled by the Investor CSD (and securities will be unblocked automatically by T2S as the CoSD Hold took place on the Business Instructions).

For cross-CSD scenarios where the participant of KELER is receiving securities subject to cash settlement in HUF, no CoSD rule will be triggered. Furthermore, in case of cross-CSD transaction between Investor CSDs’ participants, where only the realignment instructions would take place at KELER, no CoSD rule will be triggered as the currency information is not populated in the realignment instructions and would therefore not match the CoSD rule.

4.7.6 OeKB CSD

Pre T2S – Process Controls

OeKB CSD provides settlement services in multiple currencies in Commercial Bank Money via links it maintains with Clearstream Banking Luxembourg (CBL), Euroclear Bank (EB), and National Settlement Depository (Russia’s CSD) for the following currencies¹⁰³: USD, GBP, RUB, CHF. The service is provided for all eligible securities in OeKB CSD. To benefit from this service, OeKB CSD participants must hold a cash account per currency at OeKB CSD¹⁰⁴. Non-Euro currency settlement services are available to Investor CSDs. As such, there is no specific process put in place for settlement in non-Euro currencies, but securities (or cash) are reserved in the case of DVP (resp. RVP) transactions where OeKB CSD acts as Investor CSD, and debited upon settlement confirmation from the Issuer CSD, according to current market practices. Business validation rules are put in place in OeKB CSD to ensure correct usage of the service.

Adapted State – Process Controls

OeKB CSD will continue to provide settlement services in currencies ineligible for settlement in T2S for the following currencies: USD, GBP, CHF. The service will not be available to Investor CSDs (which are defined as internal CSDs in T2S), and will be restricted to intra-CSD transactions submitted via OeKB CSD for ICPs having subscribed to the service. For this purpose, no restriction rules will be set up; however a CoSD rule “RS-3” will be defined for transactions instructed by OeKB CSD in the accepted

¹⁰² As per UDFS page 424: “For a pair of Settlement Instructions free of payment (FOP), the process checks if a CoSD Rule set, administered from the securities side, is defined in the Static data by the delivering CSD;”

¹⁰³ OeKB CSD also provides Commercial Bank Money settlement in Euro via CBL ~~and EB~~

¹⁰⁴ OeKB CSD has a full banking license and is holding cash accounts for its participants

currencies, to temporarily block the securities delivery while cash settlement is performed in OeKB CSD. The parameters configured in the rules are listed below:

- Currencies: List of eligible currencies: USD, GBP, CHF
- Securities movement type: DELI
- Payment Type Code: Free
- Instructing Party: OeKB CSD (CSD.A)
- Settlement Transaction Condition Code: SPDL

No Market-Specific Attribute will be used for this purpose. The optional matching field “Common Trade Reference” will be populated by OeKB CSD¹⁰⁵.

Cross-CSD Impact Analysis

Impact on Investor CSD account configuration

No impact has been identified since settlement in ineligible T2S settlement currencies will not be available to Investor CSDs of OeKB CSD in T2S. Furthermore, even for domestic participants, no segregation or static data configuration (MSA) is foreseen at account level in T2S for the provision of this service, related business validations will be managed outside T2S.

Impact on Investor CSD settlement flows

The CoSD rule “RS-3” defined by OeKB CSD will only be triggered when the Instructing Party is OeKB CSD, as the service will only be offered to ICPs upon subscription. OeKB CSD will therefore ensure that transactions in currencies ineligible for settlement in T2S are intra-CSD only. Since the service will not be available to Investor CSDs of OeKB CSD, any cross-CSD transaction in such currency would result from erroneous instructions. A transaction between a participant of OeKB CSD and an Investor CSD’s participant would either not settle and the Business Instruction on the Investor CSD side remain unmatched (as the ICP instruction will be filtered out by OeKB CSD) or settle as a FOP transaction (if e.g. the OeKB CSD participant instructs as a DCP, or if both counterparties trade in an ineligible currency). In the case of a transaction between participants of Investor CSDs so that only the realignment takes place in OeKB CSD, the rule will not affect the realignment instructions, since realignment instructions do not include the currency field.

Conclusion

Several CSDs (The Latvian CSD (LCSD), Clearstream, Interbolsa, KELER, OeKB CSD) will offer external cash settlement services to their participants, i.e. settlement in currencies non-eligible in T2S. To this end, they will use the “Conditional Securities Delivery” (CoSD) functionality available

¹⁰⁵ Cash details are not taken into account for matching by T2S in the case of FOP instructions, therefore populating the “Common Trade Reference” further minimises risks of mismatching

in T2S, which allows blocking the securities leg of the transaction while the cash leg settles outside T2S, then in a second step to settle the securities in T2S. Clearstream will complement the CoSD process with other restriction rules, to perform additional validations before the Intended Settlement Date: verification of cash details in matched FOP instructions, or verification of business validation rules setup outside T2S, for instructions sent by DCPs.

For all CSDs but KELER, external cash settlement services in non-T2S currencies will not be part of the service offering to Investor CSDs¹⁰⁶. Impact on Investor CSDs' settlement flows is to be considered limited, as CoSD rules have been configured to exclude any impact on Investor CSDs' instructions, even in the case of erroneous transactions.

By design, T2S generated Realignment Instructions do not include a currency and will never be impacted by external cash settlement rules that include currencies as parameter. Note that this also prevents the CSDs offering settlement services in these currencies to have the necessary control over the transaction in order to provide the service to Investor CSDs when both Business Instructions come from Investor CSDs' participants.

In the case of KELER, the service will be available to Investor CSDs, and Investor CSDs would need to implement the CoSD rule implemented by KELER in their data scope for the reason mentioned here above, i.e. currency is not transposed in T2S generated Realignment Instructions.

There is potential room for harmonisation in the definition of restriction rules among CSDs; for example, settlement instructions in ineligible currencies are rejected in a CSD, and are eligible to settle as normal FOP in others. Handling of erroneous cross-CSD transactions is also different among CSDs due to the parameters of the CoSD rules.

Until the implementation of the CR T2S-0526-URD, the optional matching field "common trade reference" can be populated with cash details by CSDs when sending settlement instructions in currencies non-eligible in T2S. This may reduce but will not eliminate risks of mismatching¹⁰⁷.

BOGS will use the CoSD functionality differently, in order for the central bank to verify that the cash provision is available in its internal systems, before authorising the settlement of the transaction and debit of the T2S Dedicated Cash Account (DCA) used for this service. The service is only relevant to certain categories of domestic participants who have no cross-CSD activity, which excludes impact on Investor CSDs.

¹⁰⁶ which are defined as internal CSDs in T2S

¹⁰⁷ Cash details are not taken into account for matching by T2S in the case of FOP instructions. Such details can be added in the common trade reference field when sending FOP in non-T2S currencies to reduce the risk of mismatching. The CR T2S-0526-URD

4.8 External CSD Settlement

Introduction

For the assessment of restriction rules according to the methodology defined in Section 2.2 “Methodology to quantify impacts on Investor CSDs”, External CSD Settlement is categorised as an necessary or an optional service from an Investor CSD’s standpoint, depending on whether the CSD defining the rules is acting as Issuer CSD, or Investor CSD (Technical Issuer CSD) of a CSD external to T2S.

In the context of T2S, External CSD Settlement can be defined as settlement which involves at least one CSD not participating in T2S.

Prior to T2S, settlement of all cross-CSD transactions involving multiple CSDs is performed in 2 steps:

1. Settlement is carried out by the *Issuer CSD*
2. Settlement is reflected by the *Investor CSD* in its books.

The cross-CSD securities settlement mechanism requiring a 2-step process will no longer exist in T2S for scenarios where both CSDs are participating to T2S, as settlement will take place on a single platform on an all or none basis.

This 2 step process will still be required, depending on the scenario, if one of the CSDs is not participating in T2S. External CSD Settlement scenarios in T2S involve at least one CSD outside T2S:

- The “*External CSD*” T2S Party type is considered as a CSD participant of the CSD in T2S
- In order for external CSD settlement to take place in T2S, each Investor CSD in T2S needs at least one omnibus account in the books of its Technical Issuer CSD in T2S and an equal number of mirror accounts and inter-CSD accounts (used for external CSD settlement with external issuer CSDs only) in its own books.

Figure 21 - Example of external-CSD account structure with issuer CSD external to T2S

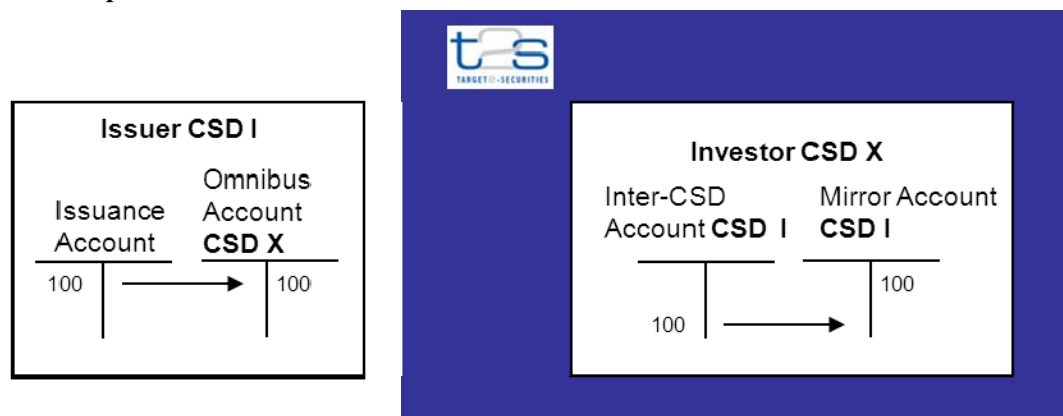

CSDs can use the T2S functionality for Conditional Securities Delivery (CoSD). The CoSD functionality also requires the set-up of rules in T2S which may impact cross-CSD settlement.

Although in the T2S specifications, only one External CSD Settlement scenario is described as conditional in T2S, it is up to CSDs to define which scenarios require conditionality.

For the impact analysis of CoSD rules, we will be looking at the need for replication by an Investor CSD of the Technical Issuer CSD in T2S, as represented in the diagram below:

Example of Investor CSD using a Technical Issuer CSD in T2S for external CSD settlement

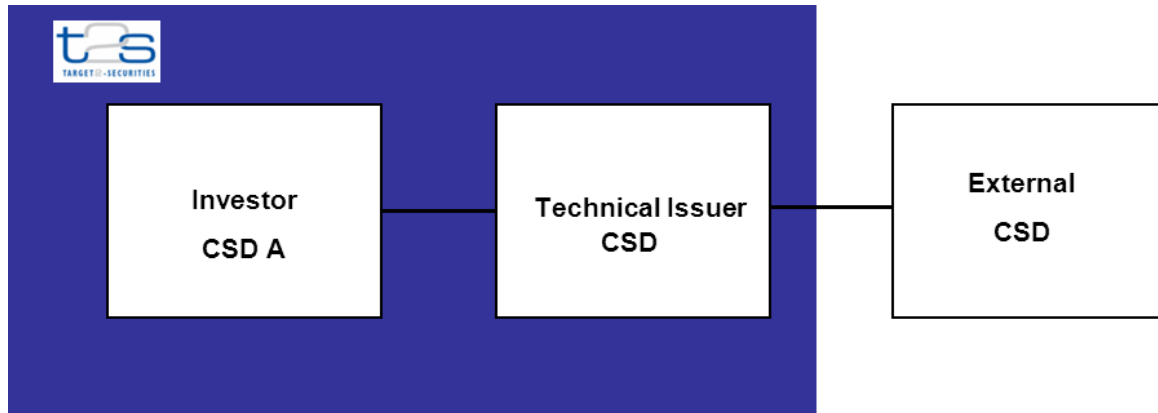

The description of current services, CoSD rules for External CSD Settlement, and impact analysis by market, are detailed in the next sections.

4.8.1 Clearstream Banking Frankfurt (CBF)

Pre T2S – Process Controls

Prior to T2S, CBF has direct CSD links to most European (future T2S) markets, e.g. Austria (OeKB CSD), Belgium (NBB and Euroclear Belgium - ESES), France (Euroclear France - ESES), Luxembourg (VP Lux and LuxCSD), Italy (Monte Titoli), etc...

Adapted State – Process Controls

CBF has defined a Conditional Securities Delivery (CoSD) rule in order to block securities when there is a transaction involving an issuer CSD external to T2S in order to control that an external settlement condition has been fulfilled prior to settlement in T2S. This will allow CBF to coordinate the settlement of instructions in T2S with a cash or securities settlement leg outside T2S.

CoSD – Securities blocking

The CoSD rule “OUT-CSD Settlement” will put on CoSD Hold all realignment instructions on the inter-CSD account where the Issuer CSD of the security is not in T2S.

The parameters configured in the rule are listed below:

- Administration Type:

- Securities
- Issuer CSD in T2S:
 - NO
- Transaction identification:
 - REAL
- Securities Account
 - Inter-CSD account

Impact on Investor CSD account configuration

Some external CSD settlement scenarios require specific account configuration in T2S from the CSD acting as Technical Issuer CSD (e.g. use of an inter-CSD account when the issuer CSD is external to T2S). Nevertheless, these requirements do not apply to Investor CSDs of the Technical Issuer CSD. No impact on Investor CSDs' account configuration has been identified.

Impact on Investor CSD settlement flows

For the purpose of the analysis, the scenario wherein an Investor CSD in T2S uses CBF as its Technical Issuer CSD to settle a transaction with a counterparty in a CSD external to T2S is considered.

The CoSD rule "OUT-CSD Settlement" will put on CoSD Hold all realignment instructions on the inter-CSD account where the Issuer CSD of the security is not in T2S.

As such, the rule will always be triggered in case of a cross-CSD transaction between an Investor CSD's participant of CBF and a participant of the External CSD, as the realignment instructions generated by T2S will match the rule. This alleviates the need for Investor CSDs to replicate the rule in case of securities delivery to the External CSD. In case of receipt against payment from an External CSD, while the rule will be triggered and the transaction pending, no cash blocking will take place. Investor CSDs should also assess if cash blocking is required for their participants, as this can in no case be configured by the Technical Issuer CSD on behalf of its Investor CSDs.

4.8.2 Euroclear Finland

Pre T2S – Process Controls

Euroclear Finland maintains a free-of-payment cross-CSD link with Euroclear Sweden, which is a CSD external to T2S.

Adapted State – Process Controls

Euroclear Finland has defined a Conditional Securities Delivery (CoSD) rule in order to block securities when there is a transaction involving Euroclear Sweden (when Euroclear Finland is acting as Investor CSD) in order to control that an external settlement condition has been fulfilled prior to settlement in

T2S. This will allow Euroclear Finland to coordinate the settlement of instructions in T2S with a cash or securities settlement leg outside T2S.

CoSD – Securities blocking

The CoSD rule “RS_1” will put on CoSD Hold all realignment instructions on the inter-CSD account where the Issuer CSD of the security is not in T2S.

The parameters configured in the rule are listed below:

- Administration Type:
 - Securities
- Transaction identification:
 - REAL
- Securities Account
 - Inter-CSD account

Impact on Investor CSD account configuration

Some external CSD settlement scenarios require specific account configuration in T2S from the CSD acting as Technical Issuer CSD (e.g. use of an inter-CSD account when the issuer CSD is external to T2S). Nevertheless, these requirements do not apply to Investor CSDs of the Technical Issuer CSD. No impact on Investor CSDs’ account configuration has been identified.

Impact on Investor CSD settlement flows

For the purpose of the analysis, the scenario wherein an Investor CSD in T2S uses Euroclear Finland as its Technical Issuer CSD to settle a transaction with a counterparty in a CSD external to T2S is considered.

The CoSD rule “RS_1” will put on CoSD Hold all realignment instructions on the inter-CSD account where the Issuer CSD of the security is not in T2S.

As such, the rule will always be triggered in case of a cross-CSD transaction between an Investor CSD’s participant of Euroclear Finland and a participant of the External CSD, as the realignment instructions generated by T2S will match the rule. This alleviates the need for Investor CSDs to replicate the rule in case of securities delivery to the External CSD. In case of receipt against payment from an External CSD, while the rule will be triggered and the transaction pending, no cash blocking will take place. Investor CSDs should also assess if cash blocking is required for their participants, as this can in no case be configured by the Technical Issuer CSD on behalf of its Investor CSDs.

4.8.3 Iberclear

Pre T2S – Process Controls

Iberclear has put in place CSD links with two depositories in Latin America (Argentina and Brazil). Those links are only allowing free-of-payment transfer of securities.

Adapted State – Process Controls

Note: It has been notified to Iberclear that the Conditional Securities Delivery functionality built in T2S would allow achieving the required level of controls instead of using the set of restriction rules below.

Iberclear has defined the below restriction rules, when acting as Technical Issuer CSD of an External CSD, in order to control that settlement at the external depository is effected prior to settlement in T2S. Those restrictions will only be necessary in a specific business scenario, where a participant of Iberclear (including Investor CSDs) is delivering to a participant of the Argentinian or Brazilian depository.

- “BLO1”: a Case 3 Restriction Type created to block securities in a dedicated securities position. This segregation is planned in the context of external CSD settlement where Iberclear blocks the securities to be delivered to an External CSD while waits for the confirmation that the settlement outside T2S is effected.
- “IBR1”: a negative rejection rule (Case 1 Restriction Type). The rule will be used in this context to bypass the validation defined in the rule “RSP1” when settlement instructions are sent by Iberclear.
- “RSP1”: a positive rejection rule (Case 1 Restriction Type). The rule is defined to restrict the usage of the securities positions blocked for external CSD settlement so that all settlement instructions sent on this restricted position (“BLO1”) are rejected.
- “IBR2”: a negative rejection rule (Case 1 Restriction Type). The rule will be used in this context to bypass the validation defined in the rule “RSP2” when settlement restrictions are sent by Iberclear.
- “RSP2”: a positive rejection rule (Case 1 Restriction Type). The rule is defined to restrict the usage of the securities positions blocked for external CSD settlement so that all settlement restrictions sent on this restricted position (“BLO1”) are rejected.

The parameters configured in these rules are listed below:

IBR1/IBR2:

- Instructing Party Type, with the value:
 - CSD

RSP1/RSP2:

- Credited/Debited Position Balance, with the value:
- “BL01”: specific blocked position type to be used in the context of external CSD settlement.

Cross-CSD Impact Analysis

Impact on Investor CSD account configuration

This service is not available to Investor CSDs and participants instructing in DCP mode in the business scenario where the restriction rules apply. In those business scenarios, Investor CSDs of Iberclear would have to instruct Iberclear in ICP mode. This would entail segregation of securities positions: Iberclear would block the positions on the omnibus account of the Investor CSD, while the Investor CSD would have to reflect this blocking on the accounts of its participants.

Impact on Investor CSD settlement flows

This service is not available to Investor CSDs and participants instructing in DCP mode in the business scenario where the restriction rules apply, i.e. a delivery from an Investor CSD’s participant to a participant of the Argentinian or Brazilian depository. In other cases, the transaction could settle STP.

If they would instruct Iberclear in ICP mode for the purpose of delivering securities to a Brazilian/Argentinian counterparty, they should implement similar restriction rules as “RSP1 + IBR1 + BL01” and “RSP2 + IBR2 + BL01”, in order to be able to restrict the securities in their participant account, prior to Iberclear performing the blocking on the omnibus account. In case they would fail to do so, there would be a desynchronization between available securities positions on omnibus, mirror and participant accounts.

4.8.4 Monte Titoli

Current State – Process Controls

Prior to T2S, Monte Titoli has ~~currently~~ direct (ICSD) links to the following markets: Austria (OeKB CSD), Belgium (NBB and Euroclear Belgium - ESES), France (Euroclear France - ESES), Germany (Clearstream Banking Frankfurt), Greece (BOGS), Ireland (Euroclear UK&IE operated by Citi), Luxembourg (VP Lux), Spain (Iberclear), Switzerland (SIX-SIS), The Netherlands (Euroclear Netherland - ESES), UK (Euroclear UK&IE operated by Citi), United States (DTCC), Euroclear Bank and Clearstream Banking Luxembourg.¹⁰⁸

Adapted State – Process Controls

¹⁰⁸ Adapted from Monte Titoli website <http://www.lseg.com/post-trade-services/settlement-and-custody/monte-titoli/cross-border/securities-markets>

Monte Titoli has defined a Conditional Securities Delivery (CoSD) rule in order to block securities when there is a transaction involving a CSD external to T2S (when Monte Titoli is acting as Investor CSD) in order to control that an external settlement condition has been fulfilled prior to settlement in T2S. This will allow Monte Titoli to coordinate the settlement of instructions in T2S with a cash or securities settlement leg outside T2S. External CSDs will be all CSDs which have not migrated to T2S.

CoSD – Securities blocking

The CoSD rule “CEXT” will put on CoSD Hold the following instructions:

- Receiving settlement instructions where delivering CSD is outside T2S, triggering CoSD securities blocking.
- Delivering settlement instructions where receiving CSD is outside T2S, triggering CoSD securities blocking.

The parameters configured in the rules are listed below:

- Administration Type:
 - Securities
- Delivering CSD in T2S:
 - NO
- Receiving CSD in T2S:
 - NO
- Securities movement type:
 - Receiving
 - Delivering

Cross-CSD Impact Analysis

Impact on Investor CSD account configuration

Some external CSD settlement scenarios require specific account configuration in T2S from the CSD acting as Technical Issuer CSD (e.g. use of an inter-CSD account when the issuer CSD is external to T2S). Nevertheless, these requirements do not apply to Investor CSDs of the technical Issuer CSD. No impact on Investor CSDs’ account configuration has been identified.

Impact on Investor CSD settlement flows

For the purpose of the analysis, the scenario wherein an Investor CSD in T2S uses Monte Titoli as its Technical Issuer CSD to settle a transaction with a counterparty in a CSD external to T2S is considered.

The CoSD rule “CEXT” by Monte Titoli will put on CoSD Hold the following instructions:

- Receiving settlement instructions where delivering CSD is outside T2S, triggering CoSD securities blocking.

- Delivering settlement instructions where receiving CSD is outside T2S, triggering CoSD securities blocking.

The rule will not be triggered in case of a cross-CSD transaction between an Investor CSD's participant of Monte Titoli and a participant of the External CSD, as the realignment instructions generated by T2S and checked by the rule will always contain Monte Titoli as delivering/receiving CSD. The Business Instruction sent by Monte Titoli on behalf of the External CSD will also not trigger the rule, as in case of receiving settlement instruction the delivering CSD is Monte Titoli, and in case of delivering settlement instruction the receiving CSD is Monte Titoli. This could be problematic as the Investor CSD's participant would deliver securities to or receive securities from the inter-CSD account of Monte Titoli, while securities settlement has not been performed at the External CSD.

To ensure the transaction is put on hold and securities are blocked in the account of their participants, Investor CSDs of Monte Titoli defining the External CSD as eligible counterpart should also implement the CoSD rule to trigger CoSD securities blocking until settlement takes place at the External CSD. They should also assess if cash blocking is required, as this can in no case be configured by the Technical Issuer CSD on behalf of Investor CSDs.

4.8.5 OeKB CSD

Pre T2S – Process Controls

Prior to T2S migration, OeKB CSD ~~currently~~ offers settlement in non-Austrian securities to its customers via a number of the following custodians and depositories links: ~~Brown Brothers Harriman, Clearstream, CSOB Bratislava, CSOB Praga, Euroclear, Keler, KDD., Monte Titoli, National Settlement Depository, SIX SIS and Zagrebačka banka.~~

This business process is named “External” and represents a transaction to be settled via a foreign custodian or depository where OeKB CSD holds safekeeping accounts on behalf of its customers. It depends on the foreign custodian/depository link arrangement whether instructions of transaction type “External” free of payment or versus payment are allowed:

- Instructions versus payment always require an instruction of the type “EDVP” (i.e. external delivery versus payment) or “ERVVP” (i.e. external receiving versus payment) ¹⁰⁹ to be submitted to OeKB CSD.
- Instructions free of payment always require an instruction of the type “EDF” (i.e. external delivery free). “ERF” (i.e. receiving free of payment) instructions, might be required to be submitted by OeKB depending on the foreign custodian/depository.

Adapted State – Process Controls

¹⁰⁹ Source: OeKB CSD's DS.Advanced User Manual http://service.oekb.at/downloads/DS.A_UserManual.pdf.

OeKB has defined a CoSD rule ~~that will be triggered~~, when acting as an Investor CSD of Clearstream Banking Luxembourg (defined as External CSD), in order to control that an external settlement condition has been fulfilled prior to settlement in T2S. This would allow OeKB CSD to coordinate the settlement of instructions in T2S with a cash or securities settlement leg outside T2S.

CoSD – Cash/securities blocking

- The rule “RS-2”, will put on CoSD Hold all realignment instructions on the inter-CSD account where the Issuer CSD of the security is not in T2S, triggering CoSD securities blocking.

The parameters configured in the rules are listed below:

- Administration Type:
 - Securities, Cash
- Issuer CSD in T2S:
 - NO
- Transaction identification:
 - REAL
- Securities Account
 - Inter-CSD account
- Delivering CSD in T2S:
 - NO
- Securities movement type:
 - RECE (receiving)
- Payment type:
 - APMT (against payment)

Cross-CSD Impact Analysis

Impact on Investor CSD account configuration

Some external CSD settlement scenarios require specific account configuration in T2S from the CSD acting as Technical Issuer CSD (e.g. use of an inter-CSD account when the issuer CSD is external to T2S). Nevertheless, these requirements do not apply to Investor CSDs of a Technical Issuer CSD. No impact on Investor CSDs’ account configuration has been identified.

Impact on Investor CSD settlement flows

For the purpose of the analysis, the scenario wherein an Investor CSD in T2S uses OeKB CSD as its Technical Issuer CSD to settle a transaction with a counterparty in a CSD external to T2S is considered.

The CoSD rule “RS-2” will put on CoSD Hold all realignment instructions on the inter-CSD account where the Issuer CSD of the security is not in T2S.

As such, the rule will always be triggered in case of a cross-CSD transaction between an Investor CSD's participant of OeKB and a participant of the External CSD, as the realignment instructions generated by T2S will match the rule. This alleviates the need for Investor CSDs to replicate the rule in case of securities delivery to the External CSD. In case of receipt against payment from an External CSD, the rule will be triggered and the transaction pending, no cash blocking will take place. Investor CSDs should also assess if cash blocking is required for their participants, as this can in no case be configured by the Technical Issuer CSD on behalf of its Investor CSDs.

In external CSD settlement scenarios where a CoSD rule is triggered, the transaction (including the whole realignment chain) will be pending until the CoSD is released by the relevant Administering Parties. Bilateral cancellation could also be required in case the settlement condition outside T2S is not fulfilled.

Conclusion

When using the Conditional Securities Delivery (CoSD) functionality built-in T2S, no impact on the account structure of Investor CSDs has been identified due to the implementation of CoSD rules for External CSD Settlement since the responsibility to create an inter-CSD account lies with the Technical Issuer CSD of the External CSD.

As regards to the Investor CSD settlement flows, whenever a CoSD rule is triggered (whether on the Business Instructions, or T2S Generated Realignment Instructions), settlement of the transaction will be prevented until the relevant administering parties of the CoSD rule release the instructions after fulfilment of the external condition outside of T2S.

Blocking of the cash or securities will always be performed in the accounts of the delivering or receiving parties, i.e. Business Instructions.

CBF, Euroclear Finland, and OeKB have defined a CoSD rule on the inter-CSD account, which is triggered when the Issuer CSD is external to T2S. This alleviates the need for Investor CSDs using CBF, Euroclear Finland, or OeKB as their Technical Issuer CSD to implement the CoSD rule in their data scope, when securities blocking is required.

In the case of Monte Titoli, the CoSD rules will not be triggered in case an Investor CSD is the delivering/receiving party in the transaction: this requires their Investor CSDs to implement the CoSD rule in case of transaction with the External CSD.

If cash blocking is needed by the Investor CSD on its participant accounts in External CSD settlement scenarios, this cannot be configured by its Technical Issuer CSD (CBF, Euroclear Finland, Monte Titoli, OeKB CSD) to cater for its needs: the Investor CSD must in this case always configure a CoSD rule in its data scope.

Iberclear has decided to rely on restriction rules and segregation of securities positions instead of the CoSD functionality. For Investor CSDs, that translates into the obligation to instruct Iberclear in ICP mode when delivering to a counterparty external to T2S, and accept securities positions to be blocked by Iberclear in a dedicated sub-position on their omnibus account.

4.9 Foreign Securities

Introduction

For the assessment of restriction rules according to the methodology defined in Section 2.2 “Methodology to quantify impacts on Investor CSDs”, when a CSD defines restriction rules as Issuer CSD, the service is categorised as necessary. When a CSD defines restriction rules as Investor CSD, the service is categorised as optional.

In the context of this analysis, foreign securities refer to securities, for which CSDs act as Issuer CSD, or Investor CSD, and for which they have defined specific controls or restrictions due to the foreign nature or denomination currency of the security. Such limitations sometimes originate from the CSD’s local rules or regulatory framework. In other cases, validation rules are put in place to ensure the consistency between the account types and foreign securities held at the CSD. In T2S, some of these controls will be materialised by restriction rules.

4.9.1 ESES (Euroclear Belgium, Euroclear France, Euroclear Netherlands)

Pre T2S – Process Controls

ESES has internal validation rules in place for the compatibility between account types (Account Nature) and securities characteristics (Security Category, Security Legal Form, Security Holding Mode). Some of these validations have been put in place to control the holdings resulting from cross-CSD activity (e.g. securities for which ESES is acting as Investor CSD, but also securities from ESES that other CSDs are holding), which can only be held on specific accounts.

Adapted State – Process Controls

Based on validation rules currently in place, ESES has defined restriction rules to check the consistency between specific Account Natures (MSA) of securities account and specific Security Categories (MSA). The below rule relates to the control between the foreign securities and the category of the security.

RT05 (ESE-014-FOR), a positive rejection rule (Restriction Type 1), will be implemented in order to reject settlement instructions on a ‘Foreign security’ (MSA: Security Category), using one of the following Account Natures as delivering or receiving account (in T2S, each Account Nature will be represented by a dedicated securities account):

- 'Direct payment on bearer securities without commission' (014)
- 'Bearer securities account excluded from direct payment' (15)
- 'Direct payment on registered securities without commission' (16)
- 'Registered securities account excluded from direct payment' (017)
- 'Securities to be converted to mandatory registered form' (044)

- 'Registered securities which come from corporate actions currently being registered with the issuer (045)'
- 'Shares of French nationalised companies that are presented for compensation' (059)
- 'Stripped securities' (060)
- 'Shares delivered following conversion of bonds' (069)
- 'Securities delivered following an exercise of warrants' (070)
- 'Shares delivered after exercise of a stock option' (071)
- 'Total issued amount of stripped securities' (078)
- 'TCN Issuing account' (092)
- 'Typical certificates in traffic' (095)
- 'Typical certificates out of traffic'(096)
- 'Blocked Securities' (107)

The below rule relates to the control between the foreign securities and the Account Nature.

RT05 (ESE-016-FOR), a positive rejection rule (Restriction Type 1), will be implemented in order to reject settlement instructions on a 'Domestic dematerialised security except drawing' (MSA: Security Category), using the following Account Nature as delivering or receiving account:

- 'Foreign securities held by another CSD (foreign organisation or foreign custodian)' (080)

ESES has defined restriction rules to check the consistency between specific Account Natures (MSA) of securities account and specific Holding Modes of securities (MSA).

The below rule relates to the control between the foreign securities and the holding mode of the security.

RT06 (ESE-027-FOR), a positive rejection rule (Restriction Type 1), will be implemented in order to reject settlement instructions on a 'securities held in Foreign CSD' (MSA: Holding Mode), using one of the following Account Natures as delivering or receiving account:

- 'Securities to be converted to mandatory registered form' (044)
- 'Registered securities which come from corporate actions currently being registered with the issuer' (045)
- 'Shares of French nationalised companies that are presented for compensation' (059)
- 'Stripped securities' (060)
- 'Underlying securities for certificates of deposit' (061)
- 'Reserved for NYSE Euronext for Tender offers' (066)
- 'Shares delivered following conversion of bonds' (069)

- 'Securities delivered following an exercise of warrants' (070)
- 'Shares delivered after exercise of a stock option' (071)
- 'Total issued amount of stripped securities' (078)
- 'Coupon paid in non-Euro currency' (079)
- 'Securities that have been blocked due to non-presentation of the certificate' (086)
- 'Securities in physical form' (091)
- 'TCN issuing account' (092)
- 'Typical certificates in traffic' (095)
- 'Typical certificates out of traffic'(096)

ESES has defined restriction rules to check the consistency between specific Account Natures (MSA) of securities account and specific Legal Form of securities (MSA).

The below rule relates to the control between the foreign securities and the legal form of the security.

RT07 (ESE-042-FOR), a positive rejection rule (Restriction Type 1), will be implemented in order to reject settlement instructions on a security whose legal form is 'foreign securities (held in EF) ' (MSA: Legal Form), using one of the following Account Natures as delivering or receiving account:

- 'Administered registered securities' (001)
- 'Registered securities (employees shareholding)' (008)
- 'Broker trading account' (010)
- 'Direct payment on bearer securities without commission' (014)
- 'Bearer securities account excluded from direct payment' (015)
- 'Direct payment on registered securities without commission' (016)
- 'Registered securities account excluded from direct payment' (017)
- 'Securities to be converted to mandatory registered form' (044)
- 'Bearer securities presented for a mandatory conversion into registered securities' (058)
- 'Shares of French nationalised companies that are presented for compensation' (059)
- 'Stripped securities ' (060)
- 'Total issued amount of stripped securities ' (078)
- 'Adjustement of the issue account (073)
- 'TCN issuing account' (092)
- 'Typical certificates in traffic' (095)

- 'Typical certificates out of traffic'(096)

Cross-CSD Impact Analysis

Impact on Investor CSD account configuration

The below Account Natures are opened for Investor CSDs for their activity:

- Ordinary securities (000)
- Administered registered securities (001) if needed for handling registered securities, for Investor CSDs of Euroclear France¹¹⁰

For the rules RT05 (ESE-014-FOR), RT06 (ESE-016-FOR), RT06 (ESE-027-FOR), no impact on the Investor CSD account configuration has been identified, as none of the Account Natures triggering the rejection are available to Investor CSDs.

For the rule RT07 (ESE-042-FOR), Investor CSDs of Euroclear France may hold the dedicated Account Nature 'Administered registered securities' (001) in order to keep registered securities. However, securities whose legal form is 'foreign securities (held in EF) ' cannot be held on this Account Nature. Therefore, Investor CSDs holding Account Nature 001 and holding such securities through ESES must segregate securities positions accordingly and potentially implement the MSAs (Account Nature – Legal Form) with the relevant values for their activity.

Impact on Investor CSD settlement flows

For the rules RT05 (ESE-014-FOR), RT06 (ESE-016-FOR), RT06 (ESE-027-FOR), none of the Account Natures triggering the rejection are available to Investor CSDs, therefore:

- For a cross-CSD transaction between an ESES participant whose Business Instruction is matching the rule parameters and a participant of an Investor CSD, the Business Instruction of the ESES participant will be rejected while the Business Instruction of the Investor CSD will remain unmatched. No realignment will be created for this transaction.
- For a cross-CSD transaction between Investor CSD(s) participants involving realignment at ESES (between omnibus accounts), the realignment instructions will not be impacted by the rule and the transaction can be eligible to settle.

For the rule RT07 (ESE-042-FOR), if the Investor CSD of Euroclear France holds the Account Nature for registered securities 'Administered registered securities' (001), there could be an impact at the level of realignment instructions:

- For a cross-CSD transaction between a participant of Euroclear France whose Business Instruction is matching the rule parameters and a participant of the Investor CSD, the Business Instruction of the

¹¹⁰ The Account Nature 001 is not available to participants of Euroclear Belgium and Euroclear Netherlands

Euroclear France participant will be rejected while the Business Instruction of the Investor CSD will remain unmatched. No realignment will be created for this transaction.

- For a cross-CSD transaction involving Investor CSD(s) participants with realignment instructions generated in Euroclear France, the rejection rule can be triggered on the realignment instructions, resulting in the Business Instructions being accepted, matched, then cancelled.

Investor CSDs holding of Euroclear France Account Nature '001' and also holding 'foreign securities (held in EF) ' securities through ESES should implement the restriction rule RT07 (ESE-042-FOR), and potentially the MSAs and relevant values for their activity (Account Nature/Security legal form).

4.9.2 Iberclear

Pre T2S – Process Controls

Iberclear acts as Issuer CSD for some securities denominated in non-Euro currencies (DKK, USD, CHF, GBP, MXN, JPY). DVP settlement is performed in Euro, but the payment of Corporate Actions proceeds is done in the denomination currency of the security. As a result, any participant wishing to service those securities is required to hold an account in the respective currency at an external cash correspondent bank. Iberclear is not performing this control for Investor CSDs, which would be responsible for the compliance to this requirement.

Adapted State – Process Controls

Iberclear has defined restriction rules in order to control the process related to securities denominated in non-Euro currencies (DKK, USD, CHF, GBP, MXN, JPY) for which it acts as Issuer CSD:

- The rule “RPVD”, a positive rejection rule (Case 1 Restriction Type), will ensure that all settlement instructions on securities denominated in non-Euro currencies (identified with MSA) will trigger a rejection
- The rule “RNVD”, a negative rejection rule (Case 1 Restriction Type), will ensure that all settlement instructions on securities denominated in non-Euro currencies (identified with MSA) will not trigger a rejection if they are realignment instructions, i.e. contain the ISO transaction code REAL
- The rule “XXXX”¹¹¹, a negative rejection rule (Case 1 Restriction Type), will ensure that all settlement instructions on securities denominated in non-Euro currencies (identified with MSA) will not trigger a rejection if they are instructed by authorised party BICs.
- The rule “IBR1”, a negative rejection rule (Case 1 Restriction Type), will ensure that all settlement instructions sent to T2S by Iberclear will not trigger any rejection.

¹¹¹ This rule has been agreed in bilateral exchanges with Iberclear but still need to be reflected in the next version of the Reference Data Extension

The parameters configured in these rules are listed below:

RPVD

- “Securities Type”, an MSA at the level of securities to identify the securities denominated in non-Euro currencies which will trigger the rejection of a settlement instruction, with the values:
 - ACD, ADE, AFS, ALE, APN, AYN

RNVD

- “Securities Type”, an MSA at the level of securities to identify the securities denominated in non-Euro currencies which will trigger the rejection of a settlement instruction, with the values:
 - ACD, ADE, AFS, ALE, APN, AYN
- Transaction Identification (ISO transaction code), with the values:
 - REAL

XXXX

- “Securities Type”, an MSA at the level of securities to identify the securities denominated in non-Euro currencies which will trigger the rejection of a settlement instruction, with the values:
 - ACD, ADE, AFS, ALE, APN, AYN
- Instructing Party, with the values:
 - BIC of the authorised parties

IBR1:

- Instructing Party Type, with the value:
 - CSD

Cross-CSD Impact Analysis

Impact on Investor CSD account configuration

The restriction rules implemented by Iberclear for securities denominated in non-euro currencies do not rely on account configuration parameters and do not rely on segregation of securities positions. A cash account in the respective currency needs to be maintained at an external cash correspondent bank, but this will not be reflected in T2S. No impact on the Investor CSD account configuration has been identified.

Impact on Investor CSD settlement flows

The restriction rules implemented by Iberclear for securities denominated in non-euro currencies will not impact realignment instructions nor DCPs authorised by Iberclear to service those securities. The restrictions would impact cross-CSD transactions involving the securities denominated in non-euro currencies as follows:

- In case of a cross-CSD transaction between a CSD participant of Iberclear that is not authorised to service those securities and a participant of an Investor CSD, the Business Instruction sent by the Iberclear participant would be rejected and the Business Instruction at the Investor CSD level would remain unmatched
- In other cross-CSD scenarios generating realignments at Iberclear, the realignment instructions will not be impacted by the rules and the transaction can be eligible for settlement

Investor CSDs servicing those securities should consider implementing similar controls in their data scope in order to ensure that their participants can receive CA proceeds in the denomination currency of the security.

Conclusion

ESES has put in place validations in the form of restriction rules, to ensure the consistency of securities holdings resulting from cross-CSD activity, inter alia foreign securities held at the CSD, and the account types holding these securities. These securities cannot be held on the account dedicated to registered securities, and in the case where Investor CSDs of Euroclear France hold foreign securities as well as the Account Nature specific to registered securities (001)¹¹², they should implement the restriction rules and MSAs with relevant values for their activity.

Iberclear is acting as Issuer CSD for some securities denominated in non-Euro currency. While those securities settle DVP in Euro, the payment of CA is done in the denomination currency of the securities. Iberclear has implemented restriction rules in this context to ensure that participants hold an account in the respective currency. This control does not apply to Investor CSDs, which are responsible to handle this requirement. In this respect, Investor CSDs servicing those securities should consider implementing similar controls in their data scope in order to ensure that their participants can receive CA proceeds in the denomination currency of the security.

¹¹² The Account Nature 001 is not available to participants of Euroclear Belgium and Euroclear Netherlands

4.10 Issuance

Introduction

For the assessment of restriction rules according to the methodology defined in Section 2.2 “Methodology to quantify impacts on Investor CSDs”, Issuance is categorised as an optional service from an Investor CSD’s standpoint, as it is not necessary for carrying out Investor CSD activity (i.e. issuance of securities is carried out intra-CSD and cross-CSD distribution happens in a second step).

Issuance of securities is defined as a procedure wherein an entity (e.g. governments, corporations or investment funds), known as the “issuer”, offers securities to raise funds¹¹³. A typical issuance process consists of activities which may include a number of actors: CSDs, issuers, issuer’s agents (investment banks acting as underwriters, dealers, transfer/payment/settlement agents etc.) registrars, national numbering agencies, custodians, etc.

Issuance is an activity under the notary function of CSDs, which aims at establishing and maintaining a system of initial bookkeeping that records the amount of a securities issued in a specific account in the name of the issuer and that enables securities transactions to be processed by book entry¹¹⁴.

Several issuance models exist in the current securities markets landscape, which vary according to:

- The actors involved in the issuance (e.g. CSD, issuer, issuing agent);
- The type of the security subject to issue (e.g. equities, debt instruments, funds)

Based on the above elements, CSDs make use of different securities account structures for the distribution of securities to the initial owners, being currently carried out intra-CSD. Whilst market-specific variations may exist, two issuance distribution models can be identified according to the accounts involved in the issuance process:

1. Two-tiered issuance distribution model - distribution directly from the issuance account

The distribution of securities takes place directly from an issuance account (i.e. any account opened in the name of an issuer in the books of the CSD on the debit of which all securities of a same issue which are admitted by the CSD are recorded¹¹⁵). Distribution can be conducted by the issuer, the issuer’s agent or the CSD.

¹¹³ Adapted from [AFME glossary of financial terms](#).

¹¹⁴ Referenced from the [“Public consultation on Central Securities Depositories \(CSDs\) and on the harmonization of certain aspects of securities settlement in the European Union” by the Commission of the European Communities](#)”.

¹¹⁵ Adapted from the Euroclear Clearing and Settlement Glossary.

Figure 22 - Two-tiered issuance distribution model - distribution from the issuance account

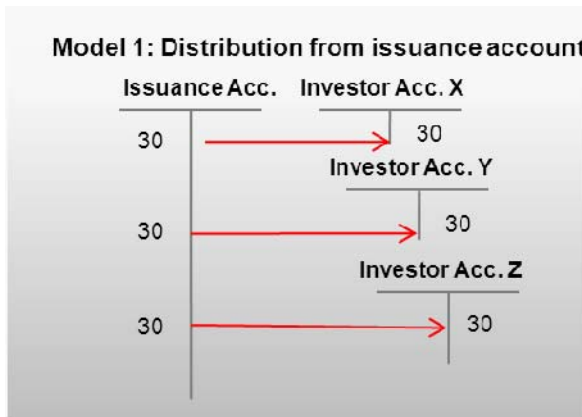

2. *Three-tiered issuance distribution model - distribution from the distribution account.*

Some issuers or issuer’s agents require the set-up of an additional distribution account for parking the issued securities credited from the issuance account until final distribution orders are available for crediting the securities accounts of initial owners. The distribution account could be in the name of the issuer or the issuer’s agent.

Figure 23 - Three-tiered issuance distribution model - distribution from the distribution account

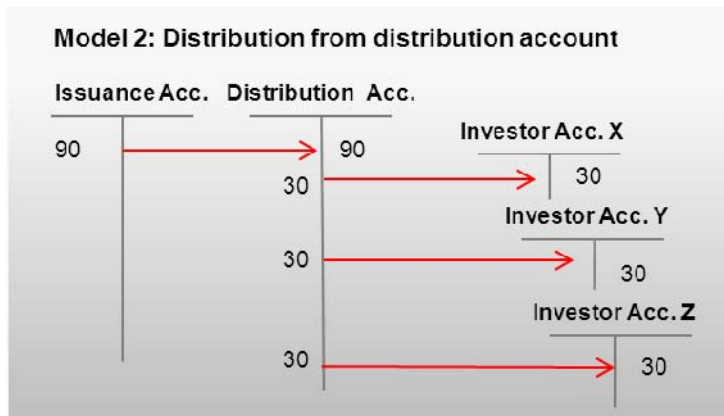

In the particular case of funds, an additional three-tiered account structure is currently frequently used: in addition to the issuance account there is a transfer agent’s issuance account (i.e. an issuance account which can have a negative/debit balance) in the name of the transfer agent (TA), and possibly another distribution account (in this specific case it would be a four-tiered issuance distribution model). This approach allows the CSD to hand the funds issuance settlement over to the TA and giving the TA the freedom to conduct the issuance out of its account. The TA can then conduct mark-up and mark-down operations in order to increase or decrease the issue amount based on subscriptions and redemption orders received. Keeping issuance accounts for every TA offers CSDs the possibility to use the services of multiple TAs.

Figure 24 - Funds issuance using Transfer Agent's Issuance Account

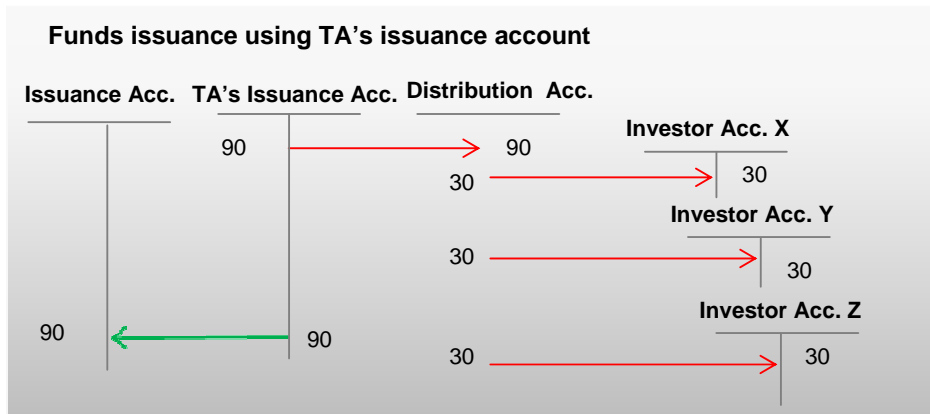

Issuance will continue to be carried out by the CSDs as part of its notary function after their migration into T2S. T2S provides the necessary functional toolkit to tailor the service to each CSD's individual business and legal requirements; i.e. the issuance related controls already in place at the CSDs and the existing *issuance distribution models* (i.e. account structures) are supported by the T2S functionality.

Issuance distribution models in T2S static data

Regarding the CSD implementation in the T2S static data of any of the *issuance distribution models*, some of the required securities account configurations in T2S are:

- Setting a securities account with account type “*issuance account*” which can be under the name of the CSD or any authorised participant¹¹⁶ (e.g. issuer or issuing agent). *Issuance accounts* are allowed to have negative positions in T2S.
- Defining the CSD in which the issuance account is held as “*issuer CSD*” of the ISIN subject to issue.

In the specific case of the *three-tiered issuance distribution model*, the relevant actor (e.g. CSD, issuer, issuing agent, TA) would need to open an additional distribution account. However, distribution accounts in T2S are standard securities accounts which do not have a specific account type. Nevertheless, CSDs have the possibility to differentiate distribution accounts in T2S by defining market-specific attributes (MSAs) on securities accounts.

In case multiple CSDs are involved in the distribution of issued securities in T2S, distribution accounts will be held in investor CSDs as depicted in the illustration below:

¹¹⁶ Refer to CR 372 “[Issuance accounts in the name of entities other than CSD](#)”

Figure 25 - Example of a Cross-Border Issuance Distribution in T2S

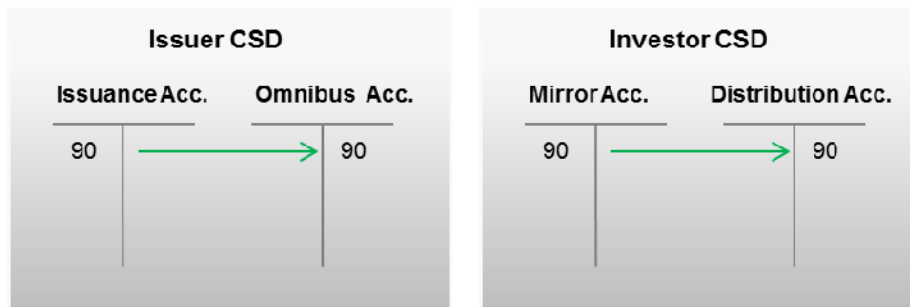

Issuance restriction rules in T2S

According to the CSD Steering group (CSG) document on CSD restriction rules, most of the issuance related restriction rules that CSDs have defined in T2S aim at controlling the actors taking part to the issuance process.

More specifically, the restriction rules for issuance are defined by CSDs either to:

- Limit access to issuance related securities accounts (e.g. issuance accounts, transferring agent accounts, distribution accounts etc.) and/or sub-position types.
- Prevent non-authorized actors to use specific transaction identifications identifying issuance related instructions (e.g. “ISSU”). These rules might be defined in combination with the type of security that constitute the subject of the issue (e.g. stripping instructions identified through the ISO code “MKDW” might be only allowed on certain types of securities).
- Reject against payment settlement instructions on issuance accounts.

It is important to note that some of the above controls can be implemented in T2S by restricting the relevant privileges (i.e. privilege to instruct against a specific securities account, privilege to make use of a specific transaction identification) to the actors involved in the issuance process (e.g. issuer, issuing agent).

Furthermore, CSDs can setup restriction rules for those issuance related checks in which several conditions have to be fulfilled (e.g. Instructions with a specific transaction identification are only accepted on a limited list of ISINs) or for specific checks that cannot be managed through standard validations (e.g. there is no privilege to restrict usage of an account sub-position).

The next sections focus on the description of current controls and future restriction rules that CSDs plan to put in place in the context of issuance, and analyse their impact on cross-CSD settlement.

4.10.1 Clearstream Banking Frankfurt (CBF)

Pre T2S – Process Controls

Issuance distribution model: *Two-tiered* and *three-tiered*

There are three ways in which registered shares are admitted to collective safe custody and to CASCADE-RS (system in CBF responsible for registered shares):

- *First deposit*
- *conversion of bearer shares into registered shares*
- *IPO with the issue of registered shares.*

The first registration of shareholders in the share ledger, on admission of registered shares to collective safe custody or in the case of credits in the form of registered shares resulting from corporate actions, is carried out via CASCADE-RS.

Adapted State – Process Controls

CBF has defined a restriction rule to prevent non-authorised actors to instruct settlement instructions including position type “RSKE” used for the issuance of registered shares. Against payment instructions will be also be rejected¹¹⁷.

CBF has defined another restriction rule to reject realignment settlement instructions referring to issuance accounts, to ensure consistency with CBF vaults (i.e. with CBF issuance processing), as in case of multi-issued securities realignment instructions would be automatically generated by T2S and CBF would like to ensure alignment with the CBF vaults preventing settlement of realignment instructions to be executed straight-through processing (STP). The process will mostly be used for multi-issued Exchange Traded Funds, where a register (e.g. in Ireland) runs the full issue, while global notes in various countries reflect the "issued portion of the full issue" in the respective country.

Furthermore, CBF has defined another restriction rule to put on (CSD Validation) Hold settlement instructions against a special purpose customer sub-account with type *Nicht Verkehrende Werte* ("unissued securities", identified with MSA) allowing issuing agents to perform some pre-activities on securities to be issued. The rule allows CBF to perform some additional market specific validations on those settlement instructions.

Finally, CBF has defined a restriction rule to put on CSD Validation Hold delivering settlement instructions against a special account type for processing of dual global bonds (identified with MSA). Dual Global Bonds (DGB) are securities which are issued in two different (I)CSDs, where in this case one of the CSDs is CBF. If DGBs are transferred between a CBF customer and a customer of the other Issuer (I)CSD, a MarkUp/MarkDown must be performed in the two issuance accounts. The coordination/communication between the two issuers is managed via an agent bank which holds a special account in CBF for this purpose. Each DGB must have exactly one agent and is therefore processed via one special purpose account only.

Rejection (Restriction case 1)

¹¹⁷ This restriction rule is analysed in the registration business process (Section 4.2.1)

“X-Border Settlement – reject” – rejects realignment instructions against issuance accounts, to ensure consistency with CBF vaults.

The parameters configured in the rules are listed below:

- Transaction identification:
 - “REAL” (i.e. realignment)
- “Konto-Art”, (MSA on securities account)
 - CBF Vaults account type, as owner of the account (Issuance processing)

CSD Validation Hold (Restriction Case 1)

The first restriction rule “Party and account configuration-CVAL” puts on hold settlement instructions against securities account with an account type reserved for special preparatory issuance processes to be performed by CBF.

The parameters configured in the rules are listed below:

- Party type of the Instructing Party: “CSD Participant”, “External CSD”
- “Konto-Art”, i.e. Account type (Market-specific attribute on Securities Account): “*Nicht Verkehrende Werte*”

The second restriction rule “Party and account configuration-CVAL” puts on hold delivering settlement instructions against securities account with an account type reserved for processing of dual global bonds. The process works as follows: once the instruction is put on CSD Validation Hold, CBF automatically generates a FOP mark up/down instruction between the DGB account and the related issuance account, links the FOP instruction to the instruction on CVAL, and releases the CVAL. The process will be executed in real time.

The parameters configured in the rules are listed below:

- Securities Movement Type: DELI (delivering settlement instructions)
- “Konto-Art”, i.e. Account type (Market-specific attribute on Securities Account): special account type reserved for processing of dual global bonds.

Cross-CSD Impact Analysis

Impact on Investor CSD account configuration

The restriction rules put in place by CBF apply on dedicated issuance accounts of CBF, or special accounts opened for agent banks in the context of dual global bonds. No impact on Investor CSDs’ account configuration has been identified.

Impact on Investor CSD settlement flows

The following restriction rules defined by CBF do not need to be implemented by Investor CSDs:

- The first restriction rule “Party and account configuration-CVAL” limits the access of some specific issuance accounts to issuing agents putting the settlement instructions on CSD Validation Hold in

order for CBF to perform additional validations. This rule should not have any impact on cross-CSD transactions

- The second restriction rule “Party and account configuration-CVAL” is used for processing of dual global bonds. For a cross-CSD transaction in a dual global bond security, an Investor CSD could experience a transaction on hold (counterparty instruction on hold) for a timeframe of around one minute until the transaction is released again, therefore the impact is negligible.
- The restriction rule “X-Border Settlement – reject” rejects realignment instructions on CBF vaults (i.e. issuance accounts) in order to ensure that cross-border settlement of multi-issued securities does not trigger realignment of securities positions involving these accounts. This rule would impact any cross-CSD transactions on a multi-issued security which triggers realignment instructions on CBF vaults.

4.10.2 ESES (Euroclear Belgium, Euroclear France, Euroclear Netherlands)

Pre T2S – Process Controls

Issuance distribution model: *Two-tiered* and *three-tiered*

Any issuer of financial instruments currently listing its securities on a Euronext market must appoint an agent (a *service financier*) in the country where the securities are admitted to trading in order to comply with the harmonised Euronext listing rules.

In the context of ESES, dedicated account types are available to issuers:

- Issuance account (Account Nature 92 or 105), which can only be adjusted by the CSD of reference in ESES;

For the distributor, a standard safekeeping account (Account Nature 000) or dedicated Account Natures are required depending on the instrument type.

Adapted State – Process Controls

In ESES, specific Account Natures with specific rights can be used by the issuing agent. Some Account Natures are specific to categories of instruments (e.g. Warrants). ESES rules will be set up to check the use of the dedicated accounts for the appropriate types of securities.

Subscription and redemption of TCN instruments can only be performed by the debit and credit of specific accounts.

Rejection (Case 1 Restriction Type)

Note: The restriction rules below are positive rejection rules, however, for the purpose of conciseness, the complete list of MSA values subject to rejection is not listed. The complete list of MSA and their values defined by each CSD is available in the Reference Data Extension document.

“RT03” and “RT05” - These restriction rules are used in the context of securities issuance checking the consistency between the following rule parameters:

- Transaction identification (ISO transaction code):
 - Issuance
 - Placement
 - Subscription
- Securities movement type:
 - RECE (receiving settlement instructions)
 - DELI (delivering settlement instructions)
- Account Nature (Market-specific attribute on securities accounts), exception list (below are some of the Account Natures which do NOT trigger rejection):
 - Issuance account (90 or 91)
 - Quasi-issuance account (62)
 - Ordinary securities (000)
 - Administered registered securities (001)
 - Securities to be distributed following an equity subscription or a new bond issue (011)
 - Securities presented for any reorganisation against cash (054)
 - 'TCN Issuing account' (092)
- Security group (Market-specific attribute on securities), non-exhaustive list:
 - Money market instruments (TCN, ECPs)
 - Warrants
 - 'T'
- Security category (Market-specific attribute on securities), non-exhaustive list:
 - 'Domestic dematerialised security except drawing'
 - 'TCN and French treasury bill'

Placement operations can only be performed by the debit and credit of specific accounts or with specific instruments:

- RT03 (ESE-004-ISS) - Settlement instructions with transaction identification 'PLAC' and securities movement type 'DELI' debiting securities accounts¹¹⁸ will be rejected, except if using the Account

¹¹⁸ This is achieved through specifying the Market-Specific Securities Account Attribute as 'DEBIT' in the rule configuration

Nature 'TCN Issuing account' (092) or 'Securities to be distributed following an equity subscription or a new bond issue' (011)

- RT03 (ESE-005-ISS) - Settlement instructions with transaction identification 'PLAC' and securities movement type 'RECE' crediting securities accounts¹¹⁹ will be rejected, except if using the Account Nature 'Securities to be distributed following an equity subscription or a new bond issue' (011) or 'Ordinary securities' (000)
- RT03 (ESE-012-ISS) - Settlement instructions with transaction identification 'PLAC' using a security belonging to any security group will be rejected, except if the security belongs to the security group 'TCN (MMI)'

Issuance of Warrants can only be performed by the debit and credit of specific accounts:

- RT03 (ESE-006-ISS) - Settlement instructions with transaction identification 'ISSU', on securities belonging to security group (MSA) 'Warrants', or 'Short Term Paper' or 'Certificate', securities movement type 'DELI', debiting a securities account for which the Account Nature is different from 'issue account' (90) will trigger a rejection.
- RT03 (ESE-007-ISS) - Settlement instructions with transaction identification 'ISSU' security group 'Warrants', securities movement type 'RECE', crediting a securities account for which the Account Nature is different from 'Securities to be distributed following an equity subscription or a new bond issue' (11) will trigger a rejection.

Subscription and redemption of TCN instruments can only be performed by the debit and credit of specific accounts:

- RT03 (ESE-052-ISS): This restriction rule rejects delivering settlement instructions with transaction identification 'ISSU', on securities belonging to security group (MSA) 'TCN (MMI)', debiting a securities account for which the Account Nature is different from 'TCN Issuing account' (092)
- RT03 (ESE-053-ISS): This restriction rule rejects receiving settlement instructions with transaction with transaction identification 'ISSU', on securities belonging to security group (MSA) 'TCN (MMI)', crediting a securities account for which the Account Nature is different from 'Securities to be distributed following an equity subscription or a new bond issue' (011)
- RT05 (ESE-017-ISS): this restriction rule rejects settlement instructions on securities flagged as 'Domestic dematerialised security except drawing' with an Account Nature equal to 'TCN issuing account' (092)
- RT05 (ESE-024-ISS): this restriction rule rejects settlement instructions on securities flagged as 'TCN and French treasury bill' on most existing Account Natures in ESES. The background is that,

¹¹⁹ This is achieved through specifying the Market-Specific Securities Account Attribute as 'CREDIT' in the rule configuration

besides the standard securities account 'Ordinary securities' (000), only a few accounts related to Issuance and CA can hold this type of securities. The Account Natures subject to rejection are:

- Administered registered securities (001)
- Bearer securities distributed to employees by their company (004)
- Registered securities (employees shareholding) (008)
- Accounts for issuer registered securities (009)
- Broker trading accounts (010)
- Direct payment on bearer securities without commission (014),
- Direct payment on registered securities without commission (016)
- Registered securities account excluded from direct payment (017)
- Fractional security proceeds to be presented for compensation (018)
- 'Securities to be distributed from stock distributions' (20,21,22,23,24,25,26,27,28,29)
- The following Account Natures: (41, 44, 45, 50, 51, 52, 53, 55, 56, 58, 60, 61, 62, 64, 66, 69, 70, 71, 72, 73, 78, 79, 80, 90, 91, 93, 94, 95, 96)¹²⁰

- RT07 (ESE-033-ISS): this restriction rule rejects settlement instructions on securities with Legal Form 'bearer or registered' on a specific account related to issuance (092)

The parameters configured in the rules are listed below:

- Security Legal Form (Market-specific attribute on securities account):
 - 'bearer or registered' (0)
- Account nature (Market-specific attribute on securities accounts):
 - 'TCN Issuing account' (092)
- RT07 (ESE-039-ISS): this restriction rule rejects settlement instructions on securities with Legal Form 'bearer' on a specific account related to issuance (105).

The parameters configured in the rules are listed below:

- Security Legal Form (Market-specific attribute on securities account):
 - 'bearer'(3)
- Account nature (Market-specific attribute on securities accounts):
 - 'New issues account' (105)

CSD Validation Hold (Case 1 Restriction Type)

¹²⁰ For the purpose of conciseness, Account Natures codes are listed here without the text description

RT18 (ESE-049-ISS): this restriction rule puts on CSD Validation Hold instructions settlement instructions instructed by CSD participants on Account Natures related to issuance enabling ESES to perform additional validations.

The parameters configured in the rules are listed below:

- Party type of the instructing party:
 - 'CSD participant'
- Account nature (Market-specific attribute on securities accounts):
 - 'Non-issued securities' (097)
 - 'Blocked securities for secondary issue' (101)
 - 'New issues account' 105
 - 'Securities exchange account' (106)

Cross-CSD Impact Analysis

Impact on Investor CSD account configuration

Issuance is initiated by ESES. In case that multiple CSDs are involved in the distribution of issued securities, distribution accounts would be held in investor CSDs. However, distribution accounts are standard securities accounts in T2S and the Account Natures used in the context of issuance are not available to Investor CSDs; therefore no impact at the Investor CSD account configuration has been identified for the following rules: RT03 (ESE-004-ISS), RT03 (ESE-005-ISS), RT03 (ESE-012-ISS), RT03 (ESE-006-ISS), RT03 (ESE-007-ISS), RT03 (ESE-052-ISS), RT03 (ESE-053-ISS), RT05 (ESE-017-ISS), RT07 (ESE-033-ISS), RT07 (ESE-039-ISS), RT18 (ESE-049-ISS).

In the specific case of the rule RT05 (ESE-024-ISS) which mandates that securities flagged as 'TCN and French treasury bill' are only held on specific accounts, those Investor CSDs of Euroclear France holding Account Nature 001¹²¹ (i.e. for registered securities) and securities flagged as 'TCN and French treasury bill' will have to segregate holdings of their participants according to the rules implemented in ESES.

Impact on Investor CSD settlement flows

Most of the restriction rules defined by ESES in the context of Issuance do not need to be implemented by Investor CSDs:

- Account Natures related to issuance and subject to rejection are not available to Investor CSDs, and/or;

¹²¹ The Account Nature 001 is not available to participants of Euroclear Belgium and Euroclear Netherlands

- Specific ISO transaction codes related to issuance are used for the configuration of the restrictions, and de facto do not apply to realignment instructions (that always carry the ISO transaction code “REAL”)

As a consequence, for the rules RT03 (ESE-004-ISS), RT03 (ESE-005-ISS), RT03 (ESE-012-ISS), RT03 (ESE-006-ISS), RT03 (ESE-007-ISS), RT03 (ESE-052-ISS), RT03 (ESE-053-ISS), RT05 (ESE-017-ISS), RT07 (ESE-033-ISS), RT07 (ESE-039-ISS), RT18 (ESE-049-ISS), there will no impact on Investor CSDs’ business instructions:

- In case of a cross-CSD transaction (i.e. distribution) between an ESES participant whose Business Instruction is matching the rule parameters and a participant of an Investor CSD, the Business Instruction of the ESES participant will be rejected while the Business Instruction of the Investor CSD will remain unmatched. No realignment will be created for this transaction.
- In other cross-CSD scenarios generating realignments at ESES (i.e. between Investor CSDs’ participants or a participant of ESES and a participant of an Investor CSD), the realignment instructions will not be impacted by the rule and the transaction can be eligible to settle.

In the specific case of the rule RT05 (ESE-024-ISS) which mandates that securities flagged as ‘TCN and French treasury bill’ are only held on specific accounts, if the Investor CSD of Euroclear France holds the Account Nature for registered securities 'Administered registered securities' (001), there could be an impact at the level of realignment instructions:

- For a cross-CSD transaction between a participant of Euroclear France whose Business Instruction is matching the rule parameters and a participant of the Investor CSD, the Business Instruction of the Euroclear France participant will be rejected while the Business Instruction of the Investor CSD will remain unmatched. No realignment will be created for this transaction.
- For a cross-CSD transaction involving Investor CSD(s) participants with realignment instructions generated in Euroclear France, the rejection rule can be triggered on the realignment instructions, resulting in the Business Instructions being accepted, matched, then cancelled.

Investor CSDs holding Account Nature 001 as well as ‘TCN and French treasury bill’ securities should implement the restriction rule RT05 (ESE-024-ISS), and potentially the MSAs and relevant values for their activity (Account Nature/Security Category).

4.10.3 KDD

Pre T2S – Process Controls

At KDD issuance is currently done in *two-tiered* issuance distribution model.

An *issuer* is an entity issuing securities entered in the central registry. Securities are issued once they are debited to an account, i.e. either a *control account* used by KDD or *floating account* used by KDD Participant acting as Distributing Agent for issue and in favour of an account holder.

Adapted State – Process Controls

KDD will introduce three-tiered issuance distribution model and also plans to define “C103”, a positive rejection (Case 1 Restriction Type) rule, for limiting the access to Distribution Accounts (DAs), which are used by KDD’s participants when acting as Distributing Agents, to ensure that in the DAs used for Issuance only Delivering Settlement Instructions are accepted and in the DAs used for Redemption only Receiving Settlement Instructions are accepted. A non-mandatory MSA will be used to classify the securities accounts used for the distribution of securities.

Rejection (Case 1 Restriction Type):

In the case of Issuance, “C103” rejects Receiving Settlement Instructions instructed by DCPs (acting as Distributing Agents) on Distribution Accounts with “Securities Movement Restriction = DELI” (identified with MSA).

In the case of Redemption, “C103” rejects Delivering Settlement Instructions instructed by DCPs (acting as Distributing Agents) on Distribution Accounts with “Securities Movement Restriction = RECE” (identified with MSA).

The parameters configured in this rule are listed below:

- Securities Movement Type:
 - DELI
 - RECE
- “Securities Movement Restriction” (non-mandatory MSA on securities accounts) used to differentiate between Distribution Accounts used for Issuance (“DELI”) and Distribution Accounts used for Redemptions (“RECE”).
- Instructing Party Type = “CSD participant”

Cross-CSD Impact Analysis

Impact on Investor CSD account configuration

Issuance is initiated by KDD. In case that multiple CSDs are involved in the distribution of issued securities, Distribution Accounts would be held in Investor CSDs and Investors CSDs would need to implement their internal controls. Therefore, no special account configuration at the Investor CSD has been identified.

In this context, it should be highlighted that Distribution Accounts in T2S are standard securities accounts which do not have a specific account type, i.e. Distribution Accounts are not part of T2S pre-configured built-in functionality. Therefore, independently of where the Distribution Accounts are held (Issuer CSD or Investor CSD), the use of Distribution Accounts in T2S (three-tiered issuance distribution model) requires specific controls to be put in place in the form of MSAs and/or restriction rules to differentiate Distribution Accounts.

Impact on Investor CSD settlement flows

There is no impact on Investor CSD settlement flows because Distributing Agents are KDD's participants and the process is transparent for Investor CSDs. The issuance is initiated by KDD instructing according to the requirements of the specific issue. Therefore, even in case of cross-CSD distribution of the issue, no specific impact on the Investor CSD settlement flow has been identified as the distribution would be always initiated by KDD according to the specific requirements of the issue.

In the specific case where the Distribution Account would be held at the Investor CSD, it would be up to the Investor CSD to decide whether to implement any specific validations on that account.

Conclusion

Most of the restriction rules defined in the context of issuance have no impact on Investor CSDs.

The issuance process itself is always carried intra-CSD, and the issuance related restriction rules apply exclusively on the Business Instructions sent by the issuer CSD in order to monitor the amount of issued securities and to ensure that the process is initiated according to the specific requirements of the issue. This is the case for most rules defined by Euroclear and one of the rules defined by CBF.

The initial distribution of the issue, in case of three-tiered issuance distribution model, could involve several CSDs. In this case, the distribution account can be held at Investor CSDs.

In the case of CBF, the restriction rule on "X-Border Settlement – reject" is defined in order to reject realignment instructions of multi-issued securities on CBF vaults account. This rule does not need to be implemented by Investor CSDs, but it would have an impact in any cross-CSD scenario on a multi-issued security which triggers realignment instructions on CBF vaults. Another rule has been defined to support the processing of dual global bonds, but will not impact settlement flows (transaction put on hold is released almost immediately in STP mode and is therefore considered transparent for the counterparties to the trade).

One restriction rule of ESES¹²², linked to the subscription and redemption of TCN instruments, only allows securities flagged as 'TCN and French treasury bill' to be held on specific accounts. This rule could impact those Investor CSDs of Euroclear France holding these securities as well as servicing registered securities (i.e. holding the dedicated Account Nature 001 required for registered securities). In such case, segregation of securities positions and restriction rules may need to be implemented by Investor CSDs.

KDD's restriction rule limits the access to distribution accounts, which are used by KDD's participants when acting as Distributing Agents, to ensure that in the distribution accounts used for Issuance only Delivering Settlement Instructions are accepted and in the distribution accounts used for Redemption only Receiving Settlement Instructions are accepted. Therefore, no impact on Investor CSD settlement flows has been identified. In the specific case of cross-CSD distribution of

¹²² RT05 (ESE-024-ISS)

the issue, where the distribution account would be held at the Investor CSD, it would be up to the Investor CSD to decide whether to implement any specific validations on that account.

4.11 Investment Funds Processing

Introduction

For the assessment of restriction rules according to the methodology defined in Section 2.2 “Methodology to quantify impacts on Investor CSDs”, Investment Funds Processing services are categorised as optional from an Investor CSD’s standpoint, as it is not necessary for carrying out Investor CSD activity (i.e. issuance/redemption of fund shares is carried out intra-CSD and cross-CSD distribution happens in a second step).

The processing of open-ended investment funds require frequent increases / decreases in the volume of funds shares corresponding to the mark-up/ mark-down process performed by the fund managers.

Common market practices for investment funds processing among CSDs include blocking securities positions for redemption or performing validation checks on investor instructions on investment funds to ensure that the counterparty is the fund and that redemption and subscription requests by intermediaries are transmitted to the issuer.

The increases/decreases in the volume of funds shares shall be settled according to the standard T2S process for securities increases/ decreases in T2S via securities issuance and redemption.

For generic information about the issuance process, distribution models, and issuance of funds, please refer to the dedicated section “4.10 Issuance” of the present document.

4.11.1 Baltic CSDs

Pre T2S – Process Controls

Settlement of open-ended funds is offered by the Baltic CSDs (Estonia, Latvia, and Lithuania) on their legacy platforms.

Fund administrators act on behalf of fund unit issuers/managers and offer distribution and settlement services to them. Fund administrators are participants of the Baltic CSDs that have been granted the right to instruct on dedicated issuance account in order to increase/decrease the amount of fund units.

An issuance account is used for the subscription (issuance and distribution) and redemption of fund units. The balance of the issuance account represents the total amount of fund units in circulation. Distribution accounts are not used for open-ended fund units.

Adapted State – Process Controls

After migration to T2S, the Baltic CSDs will provide settlement services for open-ended fund units to fund administrators (issuer agent of the investment fund) in T2S.

The Baltic CSDs plan to define the following restriction rules in this context:

Positive/Negative Rejection (Case 1 Restriction Type):

BCDR06 + BCDR07: the combination of these two restriction rules rejects all settlement instructions sent by CSD participants on accounts with status “issuance account” (identified with MSA), unless instructed by an authorised fund administrator on a combination of specific “issuance account” and ISIN(s).

The parameters configured in these rules are listed below:

- “Account Type” (MSA on securities account), with value:
 - Issuance Account
- Securities Account, with value:
 - a specific “issuance account”
- Security, with value:
 - a specific ISIN
- Party, with value:
 - a specific instructing party
- Party Type (of the instructing party), with value:
 - CSD Participant

Cross-CSD Impact Analysis

Impact on Investor CSD account configuration

No segregation is required at the level of Investor CSDs. Furthermore, the so-called “issuance accounts” subject to rejection are not held by Investor CSDs; therefore no impact on the Investor CSDs’ account configuration has been identified.

Impact on Investor CSD settlement flows

The restriction rules “BCDR06” and “BCDR07” implemented by the Baltic CSDs in the context of Investment Funds Processing do not need to be implemented by Investor CSDs, as the controls defined for subscription and redemption processes will not impact settlement transactions at the level of realignment. Furthermore, the so-called “issuance accounts” subject to rejection are not held by Investor CSDs.

4.11.2 ESES (Euroclear Belgium, Euroclear France, Euroclear Netherlands)

Pre T2S – Process Controls

In ESES, specific accounts are dedicated for the subscriptions and redemption of fund shares.

Adapted State – Process Controls

Rejection (Case 1 Restriction Type)

Note: The restriction rules below are positive rejection rules, however, for the purpose of conciseness, the complete list of MSA values subject to rejection is not listed. The complete list of MSA and their values defined by each CSD is available in the Reference Data Extension document.

Subscription and redemption of funds can only be performed by the debit and credit of specific accounts:

- RT03 (ESE-008-IFP) - Delivering settlement instructions with transaction identification 'SUBS' (subscription), and debiting¹²³ a securities account for which the Account Nature is different from 'Subscription / redemption of funds' (062) will trigger a rejection.
- RT03 (ESE-009-IFP) - Receiving settlement instructions with transaction identification 'SUBS' (subscription), and crediting¹²⁴ a securities account for which the Account Nature is different from 'ordinary securities' (000), 'Administered registered securities' (001), 'Accounts for issuer registered securities' (009), or 'Securities to be distributed following an equity subscription or a new bond issue' (011) will trigger a rejection.
- RT03 (ESE-010-IFP) - Delivering settlement instructions with transaction identification 'REDM' (redemption), and debiting a securities account for which the Account Nature is different from 'ordinary securities' (000), 'Administered registered securities' (001), 'Accounts for issuer registered securities' (009), or 'Securities to be distributed following an equity subscription or a new bond issue' (011), or 'Subscription / redemption of funds' (062) will trigger a rejection.
- RT03 (ESE-011-IFP) - Receiving settlement instructions with transaction identification 'REDM' (redemption), and crediting a securities account for which the Account Nature is different from 'Subscription / redemption of funds' (062) will trigger a rejection.

The parameters configured in the rules are listed below:

- Transaction identification (ISO transaction code):
 - "SUBS" (i.e. subscription)
 - "REDM" (i.e. redemption)
- Account nature (Market-specific attribute on securities accounts), exception list (below are some of the Account Natures which do NOT trigger rejection):
 - 'Subscription / redemption of funds' (062)
 - 'Securities to be distributed following an equity subscription or a new bond issue' (011)
 - 'ordinary securities' (000)
 - 'Administered registered securities' (001)
 - 'Accounts for issuer registered securities' (009)

Cross-CSD Impact Analysis

Impact on Investor CSD account configuration

¹²³ This is achieved through specifying the Market-Specific Securities Account Attribute as 'DEBIT' in the rule configuration

¹²⁴ This is achieved through specifying the Market-Specific Securities Account Attribute as 'CREDIT' in the rule configuration

No segregation is required at the level of Investor CSDs since both Account Natures 'ordinary securities' (000) and 'Administered registered securities' (001), which are the accounts held by Investor CSDs, may hold fund shares. No impact on Investor CSDs' account configuration has been identified.

Impact on Investor CSD settlement flows

The restriction rules implemented by ESES in the context of Investment Funds Processing do not need to be implemented by Investor CSDs, as the controls defined for subscription and redemption processes will not impact settlement transactions at the level of realignment (fund shares can be held on both 000 and 001 Account Natures, and realignment instructions will always carry the transaction identification code "REAL"):

- In case of a cross-CSD scenario between a participant of ESES and a participant of an Investor CSD, the Business Instruction of the ESES participant triggering the restriction rule would be rejected and the counterpart Business Instruction at the Investor CSD level would remain unmatched
- In case of a cross-CSD scenario involving realignments at ESES (between two investor CSDs' participants or a participant of ESES and a participant of an Investor CSD), the realignment instructions will not be impacted by the rule and the transaction can be eligible to settle.

A point to emphasise on ESES side is that, if the transaction code is used in order to identify subscription and redemption operations, in case of cross-CSD transaction, the Investor CSD participant's leg cannot be identified as such.

4.11.3 Interbolsa

Pre T2S – Process Controls

Interbolsa has a specific securities position blocking ('*Situations*') for funds redemption.

Adapted State – Process Controls

- Interbolsa has defined "SR03", a positive rejection (Case 1 Restriction Type) rule. The rule is generic and defined to reject settlement instructions sent by CSD participants debiting securities positions blocked/reserved for settlement ("BL29") described below. No MSA is created for this rule.
- Interbolsa has defined "SR04", a positive rejection (Case 1 Restriction Type) rule. The rule is generic and defined to reject settlement restrictions sent by CSD participants debiting or crediting securities positions blocked/reserved for settlement ("BL29") described below. No MSA is created for this rule.
- Interbolsa has defined the restriction type ("BL29") for blocking of securities positions (Case 3 Restriction Type) in the context of fund redemptions. Positions will be blocked until the fund manager confirms the redemption.

Cross-CSD Impact Analysis

Impact on Investor CSD account configuration

The restriction “BL29” is defined to block securities into a specific position type prior to redemption. In principle, Investor CSDs should also restrict the securities positions on the accounts of their participants, but can choose to segregate the positions into position types or into separate accounts. At the time of writing, this service is rarely used, even by Interbolsa’s participants. Impact on Investor CSDs is expected to be limited.

Impact on Investor CSD settlement flows

Interbolsa’s restriction rules related to Funds Processing will not have a direct impact on trade related cross-CSD transactions, as realignment instructions would not make use of the restricted positions; i.e. realignment instructions would not match the restriction rules. However, blocking of securities positions could lead to de-synchronisation of positions between omnibus and participants’ accounts and trigger a lack of available securities available on the omnibus account for settlement while the blocking applies, if the Investor CSD does not restrict the securities positions in its own account structure. At the time of writing, this service is rarely used, even by Interbolsa’s participants. Impact on Investor CSDs is expected to be limited.

Conclusion

Interbolsa will put in place a restriction rule related to redemption of funds. Funds securities will be blocked into a specific position type prior to redemption. Investor CSDs holding these securities shall also segregate and restrict these positions for settlement in their account structure via the use of a restriction rule, but are free to choose their preferred segregation method to do so (e.g. the use of separate accounts rather than position types). At the time of writing, this service is rarely used, even by Interbolsa’s participants. Impact on Investor CSDs is expected to be limited.

Baltic CSDs and ESES will also put in place restriction rules in the context of investment funds processing, for subscription and redemption operations which are only authorised on specific accounts. No impact on Investor CSDs has been identified, as the controls put in place will not apply to them.

4.12 Limitations due to CSD Legacy Platform

Introduction

For the assessment of restriction rules according to the methodology defined in Section 2.2 “Methodology to quantify impacts on Investor CSDs”, processes related to Limitations due to CSD Legacy Platform are categorised as necessary from an Investor CSD’s standpoint, as such limitations are imposed to the participants of the Issuer CSD, including Investor CSDs.

CSDs have to do a number of implementation choices in their adaptation to T2S, taking into account the design and operating model of their legacy platform.

For example, some CSDs have a specific account structure with sub-positions (i.e. position types) that will not be fully mirrored in T2S, while some other CSDs will not support the use of intra-position movements (settlement restrictions).

In order to support such implementation choices, restriction rules may be required: when these result in a limitation of the key functionalities of T2S (e.g. auto-collateralisation, Conditional Securities Delivery), or reduce the scope of settlement services available to CSD participants, including Investor CSDs, they will be documented under this Business Process.

4.12.1 CDCP

Pre T2S – Process Controls

In CDCP’s legacy systems, securities positions can be restricted multiple times through several levels of sub-positions, in which case they are not directly available for settlement. An example would be in the case a security would be restricted due to a pledge and a Court Order, or a pledge and an Executor Order.

Note that securities positions restricted from settlement affect a relatively low percentage of transactions (4%¹²⁵).

Adapted State – Process Controls

Note: CDCP will re-consider another way to implement this process after migration to T2S. Currently the CSD does not have any DCP nor Investor CSDs.

T2S allows the creation and maintenance of sub-positions, and to distinguish between available securities positions and restricted securities positions. It is not however possible to restrict a security position in several sub-positions.

Since restrictions on securities positions present in the CSD legacy system are not systematically mirrored in T2S, additional business validation has to be executed in legacy system for every DCP instruction before the settlement on respective accounts in T2S is committed in order to guarantee irrevocability of

¹²⁵ Annual volume (year 2015): DVP - 8 980 / FOP - 46 788 transfers

settlement on the accounts in T2S (Settlement Finality III – SFIII). As a result, CDCP plans to implement the following restriction rule in T2S:

- “CVAL2”, a positive CSD Validation Hold rule, will be defined to put on hold all settlement instructions sent by CSD participants (CDCP will be the Instructing Party for all ICPs)

The parameters used in the context of this rule are:

- Instructing Party Type: CSD participant

The process is automated, i.e. CDCP’s legacy system would release the CVAL in T2S in case the securities provisioning check is successful in legacy system otherwise the DCP instruction is cancelled in T2S. Check would not be performed on ISD but as a part of processing CSD Validation Hold status advice received from T2S, i.e. upon validation of the instruction.

Impact on Investor CSD account configuration

Restricted securities positions are not reflected through segregation in T2S, therefore Investor CSDs cannot implement any controls.

Impact on Investor CSD settlement flows

Securities on which a restriction exists will not be transferred to Investor CSDs as per current process, i.e. not available, as ICP instructions will not be forwarded to T2S and DCP instructions will be put on CVAL and cancelled. This means that in cross-CSD scenarios involving an Investor CSD participant as counterpart of a DCP in CDCP, bilateral cancellation with the involvement of the Investor CSD could be required.

Conclusion

CSDs’ implementation choices in their adaptation to T2S may result in limitations in the scope of functionalities or settlement services available to CSD participants.

In the case of CDCP, securities positions can be restricted from settlement through multiple levels of sub-positions and subject to additional validation in the legacy platform. Such restricted securities positions are not reflected in T2S, therefore, any DCP activity requires additional business validation from the CSD, and securities which are restricted in CDCP cannot be transferred to Investor CSDs.

Note that securities positions restricted from settlement affect a relatively low percentage of transactions (4%¹²⁶), and the CSD currently does not have DCPs or Investor CSDs. The implementation of this process will nevertheless be reconsidered after migration to T2S.

¹²⁶ Annual volume (year 2015): DVP - 8 980 / FOP - 46 788 transfers

4.13 Non-European Regulations

Introduction

For the assessment of restriction rules according to the methodology defined in Section 2.2 “Methodology to quantify impacts on Investor CSDs”, services related to Non-European Regulations are categorised as optional from an Investor CSD’s standpoint. The rationale is that, based on the CSDs in scope of the analysis, the services are provided on an optional basis to support intermediaries for identification and reporting of beneficial owners.

In the context of this analysis, non-European Regulations refer to the controls put in place by CSDs to comply with non-European regulatory requirements in the context of their activity as Issuer or Investor CSD. Note that such regulations do not necessarily impose obligations on the CSD side but can also be provided as optional added-value services to support intermediaries for identification and reporting of beneficial owners. In T2S, some CSDs have defined restriction rules materialising the controls needed to facilitate the disclosure of such requirements. Another one has implemented controls in order to support the segregation requirements imposed by some jurisdictions which are mostly non-T2S markets.

Based on the restriction rules documentation and information provided by CSDs, the following regulations are in scope of this analysis:

- **TEFRA:** The Tax Equity and Fiscal Responsibility Act (TEFRA) is a Federal Law implemented by the US Tax Authorities. The underlying TEFRA D requirements make it unlawful for the issuer of the securities to sell bearer debt securities to US citizens and persons qualifying as US tax residents within a period of 40 calendar days from the date of issue¹²⁷.

The description of current services and controls, restrictions rules, and impact analysis by market is detailed in the next sections.

4.13.1 Clearstream Banking Frankfurt (CBF)

Pre T2S – Process Controls

Clearstream provides an optional service to its participants in order to comply with TEFRA D requirements. This service is available to Investor CSDs. No quantification data is available on the number of TEFRA D securities and volume of transactions involving these securities, but the scope is broader than USD denominated securities.

Two procedures are possible when subscribing to the TEFRA D service:

- **Strict procedure:** Each time a TEFRA D security is credited to the account holder within the 40-day period, it is automatically transferred and blocked into a specific sub-account. It can be unblocked via a specific instruction, as long as Clearstream receives a statement that the participant or its own

¹²⁷ securities must initially be issued in temporary global form exchangeable for permanent global form following the 40-day restricted period

customer is not subject to the tax laws in the US and complying with TEFRA D requirements. After the end of the allocated period (40 calendar days + 3 business days), securities can only be unblocked if the issuing bank/lead manager has given its approval.

- Flexible procedure: TEFRA D securities are not initially blocked during the 40 days period, but only at the end of the 40 days. The condition is that the account holder monitors compliance with the TEFRA D rules using its own verification procedures. A detailed certification of the overall positions (own/clients) at the end of the 40-day period must be provided by the Clearstream participant. Positions blocked in a sub-account can then be unblocked via a specific instruction. After the end of the allocated period (40 calendar days + 3 business days), securities can only be unblocked if the issuing bank/lead manager has given its approval.

Adapted State – Process Controls

For the purpose of TEFRA-D processing, Clearstream has defined the rule “TEFRA D- CVAL”, a positive “CSD Validation Hold” rule (restriction type 1):

- To ensure that receiving (RECE) settlement instructions (security movement type: “RECE”) on a TEFRA D ISIN within the blocking period, for a participant to the strict procedure with specific account types, are put on “CSD Validation Hold”, so that Clearstream can initiate a transfer of the securities on a dedicated blocking account in T2S. The transfer will be sent to T2S with a link to the original receipt (WITH), and the receipt instruction will then be released so that both can settle together.
- To ensure that receiving (RECE) settlement instructions (security movement type: “RECE”) on a TEFRA D ISIN within the blocking period, for an account type with additional TEFRA-D related validation rule to be checked, are put on “CSD Validation Hold”, so that Clearstream can verify the transfer is allowed according to internal rules (transfers between the accounts of same parties are allowed, between different parties have to be checked). If not allowed, the instruction will be cancelled by Clearstream.

Three MSAs are used in this context of this rule:

- “TEFRA-D Blocking Period” on a security, to indicate whether an ISIN is within the 40-days restricted period defined by US Tax authorities. If so, the MSA indicates the current TEFRA-D period. Possible values: “Yes”, “No”
- “TEFRA-D-Teiln” on a party, to indicate whether the party is subscribing to the TEFRA D service of Clearstream, and if yes, which procedure he has chosen. Possible values: “NO”, “STRIKT”, “FLEXI”
- “Konto-Art”, this reflects CBF internal account types. Possible values: 0-99

For the purpose of TEFRA-D processing, Clearstream has also defined *Security Blocking*, a negative blocking rule (restriction type 2):

- To block settlement instructions on a TEFRA D ISIN in the last 15 min prior to the FOP deadline on the 40th day of the TEFRA D period (except if instructed with the STORNO BIC used by Clearstream) so that related securities can be moved to the dedicated blocking account in case the flexible procedure is used by the participant.

Cross-CSD Impact Analysis

Impact on Investor CSD account configuration

Investor CSDs may decide, on an optional basis, to use the TEFRA-D service of Clearstream, in which case a specific omnibus account will be opened in Clearstream to hold the blocked securities. If they opt for the strict procedure, a separate account must be opened in the Investor CSD for each participant, mapped to the blocking account in Clearstream. If they opt for the flexible procedure which is the recommendation of CBF, the impact can be alleviated provided the certification of underlying customer positions is provided to Clearstream at the end of the 40 days period, as no blocking occurs until then.

Impact on Investor CSD settlement flows

Investor CSDs offering the strict procedure services to their participants should implement a mechanism to ensure consistency between positions on TEFRA D securities, e.g. when these are transferred on the blocking omnibus account they hold at CBF: it is their choice to replicate the restriction rule or implement another process. If they opt for the flexible procedure, the impact can be alleviated provided the certification of underlying customer positions is provided to Clearstream at the end of the 40 days period.

The details of the impacts on Investor CSDs' settlement flows are described below:

- In case of a cross-CSD transaction between a participant of an Investor CSD and a participant of Clearstream, when either the participant of Clearstream or the Investor CSD has opted for the strict procedure, the transaction will be pending for settlement (either the Business Instruction in Clearstream or the T2S generated Realignment Instruction will be on CSD Validation Hold)
- In case of a cross-CSD transaction between participants of Investor CSDs where the realignment takes place in Clearstream, if either has opted for the strict procedure, the transaction will be pending for settlement (T2S generated Realignment Instruction will be on CSD Validation Hold)

The effective time during which the transaction will be pending will only be a few minutes, until CBF links the transfer to the blocking account with the original transaction. Once the linkage is confirmed, the instructions will be released for settlement.

The rule “*Security Blocking*” does not need to be activated by Investor CSDs in this context: the rule is put in place to block settlement instructions on a TEFRA D ISIN in the last 15 min prior to the FOP deadline on the 40th day of the TEFRA D period. During this short lapse of time, Investor CSDs' settlement flows will be impacted as follows:

- In case of a cross-CSD transaction between a participant of an Investor CSD and a participant of Clearstream on a TEFRA D security matching the rule parameters, the transaction will be pending, as

both Business Instructions and T2S generated Settlement Instructions will have the “security blocked” (SBLO) pending status.

- In case of a cross-CSD transaction between participants of Investor CSDs where realignment takes place in Clearstream on a TEFRA D security matching the rule parameters the transaction will be pending, as both Business Instructions and T2S generated Settlement Instructions will have the “security blocked” (SBLO) pending status.

4.13.2 ESES (Euroclear Belgium, Euroclear France, Euroclear Netherlands)

Pre T2S – Process Controls

ESES has internal validation rules in place for the compatibility between account types (Account Nature) and securities characteristics (Security Category, Security Legal Form, Security Holding Mode). In this context, ESES provides an optional service to its participants in the context of the US Regulation TEFRA D. The background of this rule is that, for Eurobonds, Custodians must provide ESES with a certificate to prove that they have no US-resident underlying clients for this security. If they fail to send this certificate, ESES will block the securities under the Account Nature: 'Securities that have been blocked due to non-presentation of the certificate' (086). According to ESES, this optional service is rarely used by its participants.

Adapted State – Process Controls

In line with existing practice, ESES has defined RT05 (ESE-18-NER), a positive rejection rule (Restriction Type 1), to reject settlement instructions on a 'Domestic dematerialised security except drawing' (MSA on securities: “Security Category”), which in this case refer to Eurobonds, on the Account Nature 'Securities that have been blocked due to non-presentation of the certificate' (086) (MSA on account: “Account Nature”) where securities would have been blocked by ESES.

Cross-CSD Impact Analysis

Impact on Investor CSD account configuration

The service can be used by Investor CSDs of all ESES CSDs: this entails that Investor CSDs willing to make use of the service need to open an omnibus account at ESES with Account Nature ‘086’, where ESES will block the securities for which it has not received the certificate requested by TEFRA D. Internally, Investor CSDs can either open a separate account for each participant and restrict access to this account by means of access rights configuration, or create a sub-position in the securities accounts of their participants, where to block (by means of an ad-hoc restriction rule) the securities included in the ‘086’ omnibus account at ESES.

Impact on Investor CSD settlement flows

Investor CSDs that would be opting for this service must ensure TEFRA-D securities blocked by ESES on Account Nature ‘086’ are restricted for settlement in their data scope (i.e. account structure). They could consider implementing the rules (and potentially the MSAs depending on their implementation

choices) of ESES, or segregate the securities positions into a restricted securities accounts. The detailed impacts on Investor CSDs' settlement flows are described below in case the Investor CSD does not implement the rule and has no mechanism to prevent settlement of TEFRA-D securities:

- In case of a cross-CSD transaction between an ESES participant whose Business Instruction is matching the rule parameters and a participant of the Investor CSD, the Business Instruction of the ESES participant will be rejected while the Business Instruction of the Investor CSD will remain unmatched. No realignment will be created for this transaction.
- In other cross-CSD scenarios generating realignment movements at ESES (i.e. between Investor CSDs' participants or a participant of ESES and a participant of an Investor CSD), if a realignment instruction matches the rule parameters, realignment instructions will not be generated while Business Instructions will be cancelled after acceptance and matching.

Conclusion

CSDs, as part of their commercial service offering, may provide optional services to their participants in order to facilitate the disclosure requirements imposed by non-European Regulations. In this context, controls are put in place to support intermediaries in the identification of end-investors.

Both CBF and ESES have defined restriction rules in the context of the TEFRA-D regulation in order to support their participants in complying with the underlying requirements. When this optional service is used by Investor CSDs, they should consider whether to implement the rules and potentially the MSAs defined by the CSDs, or a similar mechanism based on segregation of securities positions, in order to prevent settlement of TEFRA-D securities during the lock-up period. CBF also offers the choice for a “flexible” procedure which does not require segregation in the Investor CSD.

4.14 Non-Standardised Securities¹²⁸

Introduction

For the assessment of restriction rules according to the methodology defined in Section 2.2 “Methodology to quantify impacts on Investor CSDs”, services related to Non-Standardised Securities are categorised as optional from an Investor CSD’s standpoint, as such securities require specific conditions to be brought into T2S and can therefore not be considered as systematically eligible for Investor CSDs.

In the context of T2S, non-standardised securities are all those securities that are compliant with the first three T2S eligibility criteria (i.e. ISIN, held by CSD, book-entry form), but are non-fungible from a settlement perspective. Certain “non-standardised securities” that comply with the first three criteria but are not fungible from a settlement perspective may still be entered in and processed by T2S under specific conditions¹²⁹. “Fungible” from a settlement perspective means that quantities/fractions of a certain security issue (designated by a specific ISIN) are interchangeable during the settlement process and that no additional security identifier relating to a specific balance or part of a balance is required to complete valid settlement.

The present document covers restriction rules put in place for non-standardised (non-fungible) securities but also for physical securities represented by individual certificates that are fungible, meaning financial instruments which are held in physical form but settled by book-entry in the CSD.

A great majority of financial instruments held in CSDs today are dematerialised and European markets will tend towards full dematerialisation or immobilisation of securities instruments in the medium term, fostered by the Regulatory Framework. Indeed, the CSD Regulation requires securities to be recorded in book-entry form in a CSD, at least from the moment they are traded on trading venues or posted as collateral¹³⁰, but does not impose one particular method for the initial book-entry recording, which may take the form of immobilisation or of immediate dematerialisation¹³¹.

However, non-standardised securities, whether in immobilised or dematerialised form, may still exist by the launch of T2S and potentially processed on the platform.

Non-standardised securities require specific validations to be performed outside T2S to complete settlement. These processes are generally performed by Issuer CSDs and vary according to market practices.

¹²⁸ The scope of the business process also covers physical securities which are fungible from a settlement perspective

¹²⁹ URD v5.03

¹³⁰ Please refer to the Article 3 of the CSDR for the exact terms

¹³¹ See CSDR Article 2 for definition of “Dematerialised form” and “Immobilisation” of securities

4.14.1 ESES (Euroclear Belgium, Euroclear France, Euroclear Netherlands)

Pre T2S – Process Controls

Securities settlement in the ESES CSDs is carried out in book-entry form for dematerialised and physical securities. The completion of the dematerialisation process is foreseen for end 2015 for Euroclear Belgium, but some physical securities will still be held in Euroclear France (deposits of representative certificates mainly), and Euroclear Netherlands. The number of physical securities held by ESES as issuer CSD is very limited (15 ISINs) and the volume of transactions involving these securities is low.

ESES has internal validation rules in place to define the compatibility between account types (Account Nature) and securities characteristics (Security Category, Security Legal Form, Security Holding Mode). Some of these validations relate to physical securities.

Adapted State – Process Controls

Based on validation rules currently in place, ESES has defined restriction rules to check the consistency between specific Account Natures (MSA) of securities account and specific Security Categories (MSA). The below rules relate to Non-standardised securities due to the category of the security.

RT05 (ESE-020-NSS), a positive rejection rule (Restriction Type 1), will be implemented in order to reject settlement instructions on a 'physical security' (MSA: Security Category), using one of the following Account Natures as delivering or receiving account (in T2S, each Account Nature will be represented by a different securities account):

- 'Foreign companies securities presented for exchange offer or odd-lot offer' (050)
- 'Shares of French nationalised companies that are presented for compensation' (059)

Cross-CSD Impact Analysis

Impact on Investor CSD account configuration

For the rule RT05 (ESE-020-NSS), no impact on the Investor CSD account configuration has been identified, as none of the Account Natures triggering the rejection are available to Investor CSDs.

Impact on Investor CSD settlement flows

The rule RT05 (ESE-020-NSS) does not need to be replicated by Investor CSDs. Indeed, none of the Account Natures triggering the rejection are available to Investor CSDs. Investor CSD settlement flows would never be impacted at instruction level as described below:

- In case of a cross-CSD transaction between an ESES participant whose Business Instruction is matching the rule parameters and a participant of the Investor CSD, the Business Instruction of the ESES participant will be rejected while the Business Instruction of the Investor CSD will remain unmatched. No realignment will be created for this transaction.

- In case of a cross-CSD transaction between Investor CSD(s) participants involving realignment at ESES (between omnibus accounts), the realignment instructions will not be impacted by the rule and the transaction can be eligible to settle.

4.14.2 Interbolsa

Pre T2S – Process Controls

Most of the securities issues integrated in the centralised securities system managed by Interbolsa are dematerialised securities, but physical securities are accepted for deposit and immobilised in vaults administered by Interbolsa (safekeeping is performed by third-party entities). While these securities are fungible, additional steps are needed in case of deposit and withdrawals of these physical securities from the vaults (CSD counter services for attending participants in deposit and withdrawal operations). Investor CSDs may hold these securities. The number of physical securities (excluding warrants and certificates represented by global certificates) held by Interbolsa as issuer CSD is limited to 36 ISINs and the volume of transactions involving these securities is low.

Adapted State – Process Controls

Interbolsa will continue to provide settlement services for physical securities after joining T2S. The following restriction rules are planned to be defined in this context:

- “BL02”, a blocking restriction (Case 3 Restriction Type), will be implemented to block physical securities in a specific position type in case of withdrawal from the vaults, until a participant has taken physical ownership of the security.
- “SR03”, a positive rejection restriction rule (Restriction Type 1). This rule will be used to reject all settlement instructions sent by CSD participants debiting the previously defined position type “BL02”. The rule is triggered with the following parameters:
 - Party type of the instructing party, with value “CSDP” (CSD participants)
 - Debited/Credited position: “BL02”
- “SR04”, a positive rejection restriction rule (Restriction Type 1). This rule will be used to reject all settlement restrictions sent by CSD participants debiting or crediting the previously defined position type “BL02”. The rule is triggered with the following parameters:
 - Party type of the instructing party, with value “CSDP” (CSD participants)
 - Debited/credited position: “BL02”

Once physical delivery has taken place, Interbolsa will debit the securities position previously blocked for withdrawal. No Market-Specific attribute (MSA) will be used in the context of these rules.

Cross-CSD Impact Analysis

Impact on Investor CSD account configuration

The specific position type “*BLO2*” will be created in Interbolsa to block physical securities in case of withdrawal from the vaults, until a participant has taken physical ownership of the security. It is only in the hypothetical case where a participant of the Investor CSD would like to withdraw physical securities issued in Interbolsa that these securities should be blocked in the Investor CSD’s participant account until the operation is completed.

Impact on Investor CSD settlement flows

The rule “*BL02*” (used in conjunction with the rejection rule “*SR03*”) will not impact trade-related cross-CSD transactions since only the securities in the available position (“*AWAS*” Position Type) will be used by T2S generated Realignment Settlement Instructions. It is only in the case where the Investor CSD would try to debit directly the blocked position from the Omnibus account that the rejection rule (*SR03*) will be triggered, but it is questionable whether such scenario would be relevant from a business perspective.

4.14.3 KELER

Pre T2S – Process Controls

KELER provides settlement services for physical securities evidenced by certificate and registered in book-entry form. These are non-standardised (non-fungible) securities identified by sequence and serial numbers and have to be segregated on specific securities accounts. Any settlement on these securities requires additional identification information to be provided to KELER before settlement can take place. The number of non-standardised securities held by KELER as issuer CSD is about 700000, however these are illiquid securities having a low nominal value, generating a very low volume of intra-CSD transactions.

Adapted State – Process Controls

KELER will continue to provide settlement services for non-standardised securities in T2S. In this context, the following restriction rules have been defined:

- “*RT07_Non-standardised_Security*”, a positive CSD Validation Hold rule:
 - to automatically put on hold (CVAL) delivering/receiving settlement instructions respectively debiting/crediting a securities account type (MSA: Account Type) flagged as “certificate” (configured in the MSA as debit)¹³²
- “*RT07_Non-standardised_Security*”, a positive rejection rule:
 - to reject settlement restrictions containing a securities account type (MSA: Account Type) flagged as “certificate”

¹³² MSA Account Attributes are configured as ‘DEBIT’ or ‘CREDIT’ in the rule in order to ensure that delivering settlement instructions only check the delivering securities account against the MSA value and receiving settlement instructions only the receiving securities accounts against the MSA value

For the purpose of the rules, an MSA is defined at securities account level:

- “Account Type” where T2S securities accounts will be identified as “ordinary” or “certificate” (non-exhaustive list of values)

Cross-CSD Impact Analysis

Impact on Investor CSD account configuration

CSD participants of KELER must hold non-standardised securities on securities accounts flagged as “certificate” securities account type (MSA). As these are very illiquid securities, there seems to be little appeal for Investor CSDs of KELER to hold such securities: in the case where an Investor CSD intends to service non-standardised securities, it must hold a dedicated omnibus “certificate” account type, on top of an “ordinary” omnibus account (for holding standardised securities), and consider implementing the MSA for “Account type” put in place by KELER. In addition, participants’ accounts at the Investor CSD must be mapped to the correct omnibus account (for holding standardised “ordinary” securities versus holding non-standardised “certificate” securities) and their securities positions must be segregated accordingly.

Impact on Investor CSD settlement flows

The rule “RT07_Non-standardised_Security” will put on CSD Validation Hold any settlement instructions referencing securities accounts type flagged as “certificate”. In the case where Investor CSDs would service non-standardised securities, settlement flows would be impacted as follows:

- In case of a cross-CSD transaction between a participant of KELER and a participant of an Investor CSD, the Business Instruction sent by KELER’s participant (containing an account flagged as “certificate”) will be put on CSD Validation Hold and the transaction will remain pending for settlement.
- In other cross-CSD scenarios generating realignments at KELER (between Investor CSDs’ participants or a participant of KELER and a participant of an Investor CSD), realignment instructions matching the rule parameters (containing an account flagged as “certificate”) would be put on CSD Validation Hold and the transaction will remain pending for settlement.

At this stage, if non-standardised securities are transferred between compatible “certificate” account types, the transaction will be kept on hold until the involved parties have transmitted the relevant information (serial numbers) to KELER.

If on the other hand non-standardised securities are transferred on an “ordinary” account type, or standardised securities are transferred on a “certificate” account type, the transaction will have to be cancelled bilaterally with the involvement of Investor CSD(s), i.e. both Business Instructions have to be individually cancelled.

Provided Investor CSDs have segregated their participants’ securities positions (i.e. standardised vs non-standardised securities on “ordinary” vs “certificate” account) and mapped them to the relevant omnibus account at KELER, the consistency of securities positions between securities types (standardised versus

non-standardised) and account types (“certificate”, “ordinary”) will be ensured by the CSD Validation Hold rule (“RT07_Non-standardised_Security”) put in place by KELER. Indeed, for intra-Investor CSD transactions, the rule would be triggered at the level of realignment in case of incompatible transfer between securities/account types. However, in case of intra-CSD transfer of non-standardised securities between the accounts of its participants, an Investor CSD should have a mechanism in place to keep track of the additional information (i.e. serial number) attached to the security, and could consider implementing the CSD Validation Hold rule (“RT07_Non-standardised_Security”) defined by KELER.

The restriction rule “RT07_Non-standardised_Security” defined at the level of settlement restriction (object restriction type: settlement restriction) will not impact Investor CSDs’ settlement flows, except if an Investor CSD would instruct an intra-position movement directly on its omnibus account whose account type is flagged as “certificate”. Investor CSDs may consider implementing the rule depending on their operating model (i.e. creation of position types) and internal rules and procedures.

4.14.4 OeKB CSD

Pre T2S – Process Controls

In OeKB CSD, some securities can be held on an optional basis in individual custody (“Streifband”), where the reference of the specific share is assigned to the account holder, becoming de facto non-fungible. As a consequence, securities in individual custody can only be transferred from one customer account to another following a “registration” process, where the reference of the specific shares is assigned to the new account holder. This process must be done prior to settlement. CSD participants must send settlement instructions on “Streifband” securities to OeKB with additional information via the GUI.

No specific benefits are attached to “Streifband” securities, this possibility is provided in the case where investors want to own a particular part of an issue identified by a specific reference. There are only about 100 positions overall for securities in individual custody (all ISINs and all securities accounts taken into account), among which none held by Investor CSDs.

Adapted State – Process Controls

OeKB CSD has defined the below restriction rule in order to control the requirements related to securities in individual custody:

- “R-5” - positive/negative Rejection (Case 1 Restriction Type): rejects settlement instructions on accounts which are categorised as “Blocked-Special Holding Type” (identified with MSA), except if instructed with the transaction identification code “ISSU”. Note that settlement instructions in “Streifband” securities remain an ICP process, instructed only through OeKB GUI.

The parameters configured in the rule are listed below:

- “Account category” (MSA on securities accounts), with value:
 - “Blocked-Special Holding Type”
- Transaction Identification (ISO transaction code), with value:

- ISSU

Cross-CSD Impact Analysis

Impact on Investor CSD account configuration

CSD participants of OeKB CSD may decide on an optional basis to hold some securities in individual custody (“Streifband”), in which case these must be held on securities accounts flagged as “Blocked-Special Holding Type” (MSA). This would also apply to Investor CSDs, that should hold a dedicated omnibus “Blocked-Special Holding Type”, on top of an “ordinary” omnibus account.

However, as will be explained hereunder, since the process is handled in ICP mode only through the OeKB GUI, no STP process can be put in place at Investor CSD level for settlement of those securities, making it cumbersome from an operational standpoint. It must be stressed however that, as no specific right is attached to securities in individual custody, there seems to be little added value for Investor CSDs to use the possibility offered through “Streifband” securities.

Impact on Investor CSD settlement flows

The rule “R-5” will reject any settlement instructions referencing securities accounts categorised as “Blocked-Special Holding Type” unless instructed with the “ISSU” ISO transaction code. The usage of this code will be reserved to OeKB. CSD participants must send their settlement instructions and additional information through the OeKB GUI, and securities transfers in and out of these accounts are controlled by OeKB CSD, as securities in individual custody cannot settle unless each security is first being referenced to the new account holder.

This means that cross-CSD transactions on “Streifband” securities cannot settle STP: the Investor CSD would have to instruct OeKB directly through the GUI, then upon settlement in OeKB, reflect in a second step the change of securities positions on the accounts of its participants.

In the case where Investor CSDs would hold securities in individual custody, settlement flows would be impacted as follows:

- In case of a cross-CSD transaction between a participant of OeKB CSD and a participant of an Investor CSD, the Business Instruction sent by OeKB CSD’s participant (containing an account flagged as “Blocked-Special Holding Type”) would be rejected and the Business Instruction at the Investor CSD level would remain unmatched. No realignment will be triggered for this transaction.
- In other cross-CSD scenarios triggering realignment at OeKB CSD, realignment instructions matching the rule parameters (containing an account flagged as “Blocked-Special Holding Type”) would not be generated and the Business Instructions would be cancelled after acceptance and matching. There would be no possibility to bypass the restriction since realignment instructions always contain the ISO transaction code “REAL”.

Conclusion

European markets tend towards full dematerialisation or immobilisation of securities instruments in the medium term, but a small fraction of physical securities are still traded among participants. Such physical instruments, represented by individual certificates are immobilised in the Issuer CSD and subsequently traded by book-entry, making them fungible from a settlement perspective.

Based on the CSDs in scope of this analysis, the impact on Investor CSDs is expected to be limited.

In the case of Interbolsa, the controls and restriction rules that have been defined relate to the physical handling of such securities, i.e. blocking of securities positions in case of withdrawal from the vaults. Impacts on Investor CSDs settlement flows can be disregarded as a blocking on the omnibus account would only take place in case of withdrawal by one of the Investor CSD's participant.

In the case of ESES, validation rules ensure that physical securities cannot be held on specific accounts. This control does not directly impact Investor CSDs instructions since they will not hold this account nature.

In both cases described here above, the rules do not need to be implemented by Investor CSDs.

KELER holds non-standardised securities, while OeKB CSD provides the possibility to hold securities in individual custody ("Streifband"). In both cases, such securities are/become non-fungible from a settlement perspective. They are held on dedicated accounts, identified with MSA, and cannot settle STP, as the CSD needs to perform additional actions/validations prior to releasing the transaction.

In principle, Investor CSDs of KELER could implement similar controls, i.e. segregate the securities on dedicated accounts and implement the related rules and MSAs. However, in practice, there is little business case for Investor CSDs to service these securities: non-standardised securities held by KELER are very illiquid securities with a low-volume of transactions.

In OeKB CSD, it is optional for participants to hold securities in individual custody ("Streifband"), where the reference of the specific share is assigned to the account holder. The process is only possible in ICP mode, making settlement of those securities unavailable to Investor CSD in STP mode. As the recording of account holder information does not bring any special right or benefit to the holder of the security, the practical impact on Investor CSDs' settlement flows is deemed very limited.

4.15 Operational Procedures

Introduction

For the assessment of restriction rules according to the methodology defined in Section 2.2 “Methodology to quantify impacts on Investor CSDs”, the process is categorised as necessary from an Investor CSD’s standpoint, as operational procedures shall be defined by an Issuer CSD to ensure the management of operational risk on the settlement platform for all its participants, including Investor CSDs (i.e. may equally impact Investor CSDs as other participants).

Operational Procedures can be defined as operational processes and procedures put in place by CSDs to ensure smooth operation of their system, in particular in order to deal with contingency situations and take appropriate actions. In the context of the present analysis, this will translate into restriction rules defined by CSDs inter alia to bypass all other restriction rules which they have setup.

4.15.1 Baltic CSDs

Pre T2S – Process Controls

Prior to T2S, the Baltic CSDs’ operations run on a proprietary platform and IT and operational teams have the adequate controls and access rights to take corrective actions in contingency situations.

Adapted State – Process Controls

The Baltic CSDs (Estonia, Latvia, and Lithuania) have defined “BCDR15”, a Case 2 Restriction Type (intraday restriction), in order to block settlement on a security in contingency situations:

- All settlement instructions on the ISIN(s) subject to restriction will be pending for settlement while the blocking applies, except if sent by the Baltic CSDs¹³³.

Cross-CSD Impact Analysis

Impact on Investor CSD account configuration

The restriction rule “BCDR15” does not rely on account configuration parameters and the business process does not require segregation of securities positions. No impact on the Investor CSD account configuration has been identified.

Impact on Investor CSD settlement flows

The restriction rule “BCDR15” would impact Investor CSDs’ settlement flows involving the restricted security as follows:

¹³³ The Baltic CSDs are analysing the best way to implement this exception. The new parameter will be included in the next version of the Reference Data Extension.

- In case of a cross-CSD transaction on a blocked security between a participant of the Baltic CSDs and a participant of an Investor CSD, the transaction would not be eligible for settlement while the restriction applies.
- In other cross-CSD scenarios generating realignment movements at the Baltic CSDs (i.e. between Investor CSDs' participants), any transaction on the blocked ISIN(s) would not be eligible for settlement while the restriction applies.

In the case of intra-CSD transactions at an Investor CSD on the ISIN blocked at the Baltic CSDs, the intra-CSD transactions at the Investor CSD would not be prevented by the restriction rule "BCDR15" set up at the Baltic CSDs. Therefore, the rule would need to be implemented by Investor CSDs in order to ensure the integrity of securities positions.

In practice the impact on settlement flows will be limited because the restriction will only be applied in exceptional situations.

Pending transactions on the ISIN(s) to be deactivated could have to be cancelled, bilaterally with the involvement of Investor CSD(s).

4.15.2 Clearstream Banking Frankfurt (CBF)

Pre T2S – Process Controls

Prior to T2S, Clearstream's operations run on a proprietary platform and IT and operational teams have the adequate controls and access rights to take corrective actions in contingency situations. "Storno" settlement instructions are correction entries triggered by CBF for this purpose.

Adapted State – Process Controls

The T2S platform will be managed by the Eurosystem and CSDs will have control and access to the system within a predefined data scope. In this context, Clearstream has defined restriction rules wherein controls in the form of additional validations in T2S are required to manage adequately settlement flows of its participants. However, in contingency situations, Clearstream may need to bypass these restriction rules to take e.g. corrective actions. For this purpose, the following restriction rules have been defined to bypass Rejection and CSD Validation Hold restrictions rules:

- The rule "Storno – Reject", a negative rejection rule (Case 1 Restriction Type), will ensure that all settlement instructions sent to T2S with the specific Storno BIC as Instructing Party (used by Clearstream) will not trigger any rejection.
- The rule "Storno – CVAL", a negative CSD Validation Hold rule (Case 1 Restriction Type), will ensure that all settlement instructions sent to T2S with the specific Storno BIC as Instructing Party (used by Clearstream) will not be put on CSD Validation Hold.

No Market-Specific Attributes (MSA) will be defined for the purpose of these rules.

CBF has also defined restriction rules for certain business processes (e.g. issuance or vaults related activities) which are exclusively validated on Clearstream's platform. These restrictions rules configured

to exclude those instructions from other market specific validations; Rejection and CSD Validation Hold restriction rules:

- The rule “ICP only business processes - Reject”, a negative rejection rule (Case 1 Restriction Type), will ensure that all settlement instructions sent to T2S with the following characteristics will not trigger any rejection;
 - Containing specific ISO transaction code
 - Already matched FOP containing specific ISO transaction code and specific account type (Konto-Art, MSA defined at account level)
 - Already matched FOP containing specific ISO transaction code and specific party type (Konto-Gruppe, MSA defined at party level)
- The rule “ICP only business processes - CVAL”, a negative CSD Validation Hold rule (Case 1 Restriction Type), will ensure that all settlement instructions sent to T2S with the following characteristics will not be put on CSD Validation Hold;
 - Containing specific ISO transaction code
 - Already matched FOP containing specific ISO transaction code and specific account type (Konto-Art, MSA defined at account level)
 - Already matched FOP containing specific ISO transaction code and specific party type (Konto-Gruppe, MSA defined at party level)

The following parameters are used in the configuration of the rules:

- Konto-Art (MSA defined at account level): specific account types defined by CBF
- Konto-Gruppe (MSA defined at party level): specific party types defined by CBF
- Transaction identification: specific ISO transaction codes defined by CBF
- Payment Type Code: FREE (free of payment settlement instructions)
- Matching Status: MACH (already matched settlement instructions)

Furthermore, CBF has defined a temporary restriction rule in the context of the pre-migration to T2S, the time period where CSDs initially set up and maintain all relevant static data required for the successful migration to T2S. At this stage, the relevant actors are in principle granted technical access to T2S, and a restriction rule is to be defined by the T2S operator on the CSD as a party, in order to block all settlement activity of the CSD until the go-live. In addition, as recommended in the “Detailed Migration Storyline” document, CBF has defined the following restriction rule in order to reject all settlement instructions in its data scope at business validation. This restriction rule is used as a safety net on top of the one defined by the T2S operator.

- The rule “Pre-Migration Rules”, a positive rejection rule (Case 1 Restriction Type) will reject all settlement instructions against payment or free of payment within CBF’s data scope. This ensures that no settlement can take place until the go-live date¹³⁴.

The following parameters are used in the configuration of the rules:

- Payment type code: APMT, FREE

Finally, CBF has defined a restriction rule to restrict the usage of the CNBC ISO transaction code used for monetary policy operations. The usage of this code in settlement instructions allows T2S actors to settle DVP transactions with a later cut-off time in the settlement day (17:40 instead of 16:00).

The rule “CNCB related rules”, a positive rejection rule (Case 1 Restriction Type) will reject all settlement instructions containing the ISO transaction code CNBC, unless sent with the Instructing Party BIC of an NCB.

The following parameters are used in the configuration of the rules:

- Transaction identification: CNBC (Central Bank Operations)
- Instructing Party: BIC of the relevant NCB

Note that the usage of ISO transaction codes can also be restricted with configuration of access rights¹³⁵, and therefore alleviate the need for a restriction rule. However, this requires a certain granularity in the definition of users. For ICPs, CBF will instruct to T2S with the same Business Sending User and thus cannot avoid that the code CNBC is used through management of privileges, hence the need for a restriction rule. No MSA is created in the context of this rule.

Cross-CSD Impact Analysis

Impact on Investor CSD account configuration

The rules “Storno - Reject” and “Storno – CVAL” do not rely on any account configuration parameter, no impact on the Investor CSD account configuration has been identified.

The rules “ICP only business processes - Reject” and “ICP only business processes - CVAL”, no impact on the Investor CSD account configuration has been identified.

The rule “Pre-Migration Rules” do not rely on any account configuration parameter, no impact on the Investor CSD account configuration has been identified.

The rule “CNCB related rules” do not rely on any account configuration parameter, no impact on the Investor CSD account configuration has been identified.

¹³⁴ Once CBF will go live, the rule will be removed.

¹³⁵ A specific privilege must be granted for a user to be authorised to send a settlement instruction with a specific ISO transaction code

Impact on Investor CSD settlement flows

The rules “Storno - Reject” and “Storno – CVAL” may need to be implemented by Investor CSDs depending on their operational needs. They will be used by Clearstream to send settlement instructions which bypass other restriction rules and apply corrective actions in case of contingency scenarios, essentially in a domestic context. It must be stressed that using these rules in cross-CSD transactions (using the “STORNO” BIC as Instructing Party) will not allow CSDs to bypass restriction rules, since T2S generated Realignment Instructions will mention the account owner as Instructing Party.

Regardless of the usage of these rules, correction of securities positions on omnibus accounts of Investor CSDs could lead to de-synchronisation between the mirror and omnibus accounts. In this specific case, Investor CSDs would have to apply the correction in their books.

The rules “ICP only business processes - Reject” and “ICP only business processes - CVAL” will be used in specific cases by CBF in order to bypass other market-specific validations. Therefore, there would not be any impact of these rules on cross-CSD transactions.

The rule “Pre-Migration Rules” aims at ensuring that no settlement takes place on CBF’s accounts until the go-live date. Any cross-CSD transaction triggering by mistake settlement on CBF’s accounts before the go-live date would be impacted by the rule:

- In case of a cross-CSD transaction between a participant of an Investor CSD and a participant of CBF, the Business Instruction of the CBF participant will be rejected while the Business Instruction of the Investor CSD will remain unmatched. No realignment will be created for this transaction.
- In other cross-CSD scenarios generating realignments at CBF (i.e. between Investor CSDs’ participants or a participant of CBF and a participant of an Investor CSD), the rejection rule will be triggered on the realignment instructions, resulting in the Business Instructions being accepted, matched, then cancelled.

While there is no question about “replication” of the rule by Investor CSDs, all CSDs migrating to T2S could consider implementing this rule as from pre-migration as an additional safety net to ensure no settlement takes place until the go-live date.

The rule “CNCB related rules” will be used to control the usage of the CNCB ISO transaction code. The rule will only apply to Business Instructions sent by CBF participants, as realignments instructions always contain the ISO transaction code REAL:

- In case of a cross-CSD transaction between a participant of an Investor CSD and a participant of CBF, the Business Instruction of the CBF participant will be rejected while the Business Instruction of the Investor CSD will remain unmatched. No realignment will be created for this transaction.
- In other cross-CSD scenarios generating realignments at CBF (i.e. between Investor CSDs’ participants or a participant of CBF and a participant of an Investor CSD), the realignment instructions will not be impacted by the rule and the transaction can be eligible to settle.

As the usage of ISO transaction codes can be restricted with appropriate configuration of access rights, Investor CSDs willing to implement such control do not necessarily need to rely on a restriction rule.

4.15.3 ESES (Euroclear Belgium, Euroclear France, Euroclear Netherlands)

Pre T2S – Process Controls

Prior to T2S, ESES' operations run on a proprietary platform and IT and operational teams have the adequate controls and access rights to take corrective actions in contingency situations.

Adapted State – Process Controls

The T2S platform will be managed by the Eurosystem and CSDs will have control and access to the system within a predefined data scope. In this context, ESES has defined restriction rules wherein controls in the form of additional validations in T2S are required to manage adequately settlement flows of its participants. However, in contingency situations, ESES' Operations Team may need to bypass these restriction rules to take e.g. corrective actions. For this purpose, the following restriction rules have been defined:

- The rule RT19 (ESE-050-OPE), a negative rejection rule, will ensure that all settlement instructions sent to T2S with ESES as Instructing Party and with the ISO transaction code “TURN” will not trigger any rejection
- The rule RT20 (ESE-051-OPE), a negative “CSD Validation Hold” rule, will ensure that all settlement instructions sent to T2S with ESES as Instructing Party and with the ISO transaction code “TURN” will not be put on “CSD Validation Hold”

In another context, ESES has defined “RT16”, a positive blocking restriction (Case 2 Restriction Type) defined at ISIN level, in order to manage changes to fractional digits of an ISIN which are:

- Not performed in the context of a Corporate Action and therefore do not involve a change of ISIN and;
- Not covered by the CR538 which allows for inter alia change of fractional digits for securities in units (shares)

For such residual cases, i.e. change of settlement type (unit to face amount or vice versa) or redenomination of a bond where the new currency has a different number of decimals, the static data update to the ISIN relies on a specific operational procedure which requires blocking of the ISIN. Those cases are deemed rare and would most certainly result from operational errors.

There are no specific rule parameters for this restriction type applied on ISIN level.

Cross-CSD Impact Analysis

Impact on Investor CSD account configuration

The rules RT16 (ESE-058-OPE) RT19 (ESE-050-OPE) and RT20 (ESE-051-OPE) do not rely on any account configuration parameter. No impact is foreseen on Investor CSDs' account configuration.

Impact on Investor CSD settlement flows

The restriction RT16 (ESE-058-OPE) should be used in rare residual cases to manage changes to the fractional digits of an ISIN, i.e. in order to revert changes following operational errors.

Each CSD in its role as Issuer CSD/ SME should be able to block the ISIN in such circumstances with an intraday restriction. In any cross-CSD scenario generating realignment movements at ESES, the transaction in the ISIN being blocked will not be eligible for settlement while the restriction applies. Investor CSDs should also block the ISIN until the relevant static data changes and procedures have been successfully performed.

The rules RT19 (ESE-050-OPE) and RT20 (ESE-051-OPE) may be implemented by Investor CSDs depending on their operational needs. They will be used by ESES' Operations Team to send settlement instructions which bypass other restriction rules and apply corrective actions in case of contingency scenarios. Regardless of the usage of these rules, correction of securities positions on omnibus accounts of Investor CSDs could lead to de-synchronisation between the mirror and omnibus accounts. In this specific case, Investor CSDs would have to apply the correction in their books. It must be stressed that using these rules in cross-CSD transactions (using the "TURN" ISO transaction code) will not allow CSDs to bypass restriction rules, since T2S generated Realignment Instructions will mention the "REAL" ISO transaction code.

4.15.4 Euroclear Finland

Pre T2S – Process Controls

Euroclear Finland' operations run on a proprietary platform and IT and operational teams have the adequate controls and access rights to take corrective actions in contingency situations.

Adapted State – Process Controls

The T2S platform will be managed by the Eurosystem and CSDs will have control and access to the system within a predefined data scope. In this context, Euroclear Finland has defined restriction rules wherein controls in the form of additional validations in T2S are required to manage adequately settlement flows of its participants. However, Euroclear Finland' Operations Team may need to bypass these restriction rules to, for instance, process CAs. For this purpose, the following restriction rule has been defined:

- The rule "EXCA", a negative rejection rule, will ensure that all settlement instructions sent to T2S with Euroclear Finland as Instructing Party and with the ISO transaction code "CORP" will not trigger any other Case 1 rejection rule.

Cross-CSD Impact Analysis

Impact on Investor CSD account configuration

The restriction rule "EXCA" does not rely on account configuration parameters and does not involve account segregation, therefore no impact is foreseen on Investor CSDs' account configuration.

Impact on Investor CSD settlement flows

The rule “EXCA” may be implemented by Investor CSDs depending on their operational needs. It will be used by Euroclear Finland’ Operations Team to send settlement instructions which bypass other restriction rules allowing the settlement of CAs. It must be stressed that using this rule in cross-CSD transactions (using the “CORP” ISO transaction code) will not allow to bypass restriction rules, since T2S generated Realignment Instructions will mention the “REAL” ISO transaction code.

4.15.5 Iberclear

Pre T2S – Process Controls

Prior to T2S, Iberclear’s operations run on a proprietary platform and IT and operational teams have the adequate controls and access rights to take corrective actions in contingency situations.

Adapted State – Process Controls

In order to deal with contingency situations and take appropriate actions, Iberclear has defined the following restriction rules:

- The rule “IBR1”, a negative rejection rule (Case 1 Restriction Type), will ensure that all settlement instructions sent to T2S by Iberclear will not trigger any rejection.
- The rule “IBR2”, a negative rejection rule (Case 1 Restriction Type), will ensure that all settlement restrictions sent to T2S by Iberclear will not trigger any rejection.
- The rule “BIS1”, an intraday restriction (Case 2 Restriction Type), will block settlement on a security, except for settlement instructions sent by Iberclear (Party Type of the Instructing Party: CSD)
- The rule “BSA1”, an intraday restriction (Case 2 Restriction Type), will block settlement on a security account, except for settlement instructions sent by Iberclear (Party Type of the Instructing Party: CSD)
- The rule “BPA1”, an intraday restriction (Case 2 Restriction Type), will block settlement on a party, except for settlement instructions sent by Iberclear (Party Type of the Instructing Party: CSD)
- The rule “BIS3”, an intraday restriction (Case 2 Restriction Type), will block settlement on a security during critical changes (MSU, SUM, ST, DSU, etc), except for auto-collateralisation and realignment settlement instructions (i.e. settlement instruction with ISO transaction code “AUTO” or “REAL”). Iberclear has defined this restriction rule in order to deal with residual cases of SUM changes (check the CR538) which will not be covered by CR538¹³⁶.

¹³⁶ A procedure is being discussed at the level of the Operations Managers Group (OMG). After finalisation of the discussions in the OMG, the need for having this rule should be reviewed

The parameters configured in the rules are listed below:

IBR1/IBR2/BIS1/BSA1/BPA1:

- Instructing Party Type, with the value:
 - CSD

BIS3:

- Transaction Identification (ISO transaction code), with the values:
 - AUTO, REAL

Cross-CSD Impact Analysis

Impact on Investor CSD account configuration

The restriction rules “IBR1”, “IBR2”, “BIS1”, “BSA1”, “BPA1”, and “BIS3” do not rely on account configuration parameters and the business process does not require segregation of securities positions. No impact on the Investor CSD account configuration has been identified.

Impact on Investor CSD settlement flows

The restriction rules “IBR1” and “IBR2” will be used by Iberclear to send settlement instructions/restrictions which bypass other restriction rules and apply corrective actions in case of contingency scenarios, essentially in a domestic context. Settlement of trade-related transactions at Investor CSDs is therefore not impacted. Depending on the operational needs of Investor CSDs, the need for defining similar rules as the ones implemented by Iberclear may be considered.

The restriction rule “BIS1” would impact cross-CSD transactions involving the restricted security as follows:

- In case of a cross-CSD transaction on a blocked security between an Iberclear participant and a participant of an Investor CSD, the transaction would not be eligible for settlement while the restriction applies.
- In other cross-CSD scenarios generating realignment movements at Iberclear, transactions on the blocked security would not be eligible for settlement while the restriction applies.

In practice the impact on settlement flows will be limited because the restriction will only be applied in exceptional situations.

Intra-CSD transactions at Investor CSDs would not be impacted by the restriction rule “BIS1” set up at the Issuer CSD. Therefore, in order to ensure the integrity of securities positions, the rule will need to be implemented by Investor CSDs.

The restriction rules “BPA1” and “BSA1” would impact cross-CSD transactions involving the blocked party/securities account(s) as follows:

- In case of a cross-CSD transaction between an Iberclear participant (blocked at party level or account level) and a participant of an Investor CSD, the transaction would not be eligible for settlement while the restriction applies.
- In other cross-CSD scenarios generating realignment movements at Iberclear, in the specific case where the securities account being blocked is owned by an Investor CSD, the transaction would not be eligible for settlement while the restriction applies.

In practice the impact on settlement flows will be limited because the restriction will only be applied in exceptional situations.

In case the blocked participant is also participant in an Investor CSD, the blocking of the party (and/or its underlying securities accounts) would also be required to be activated in the Investor CSD’s data scope, and a restriction rule should be in place to cope with this scenario. Indeed, intra-CSD transactions at an Investor CSD on a party that is blocked at Iberclear would not be prevented by the rules.

The restriction rule “BIS3” would impact cross-CSD transactions involving the restricted security as follows:

- In case of a cross-CSD transaction on a blocked security between an Iberclear participant and a participant of an Investor CSD, the transaction would not be eligible for settlement while the restriction applies.
- In other cross-CSD scenarios generating realignment movements at Iberclear, transactions on the blocked security would be eligible for settlement since realignment instructions will bypass the rule.

In practice the impact on settlement flows will be limited because the restriction will only be applied in exceptional situations.

Intra-CSD transactions at Investor CSDs would not be impacted by the restriction rule “BIS3” set up at the Issuer CSD. Therefore, in order to ensure the integrity of securities positions, the rule would need to be implemented by Investor CSDs (depending on the outcome of the discussions in the OMG).

Regardless of the usage of these rules in a contingency scenario, it should be highlighted that, correction of securities positions on omnibus accounts of Investor CSDs, i.e. directly debiting or crediting the omnibus account, could lead to de-synchronisation between the mirror and omnibus accounts. In this specific case, Investor CSDs would have to apply the correction in their books.

4.15.6KDD

Pre T2S – Process Controls

Prior to T2S, KDD's operations run on a proprietary platform and IT and operational teams have the adequate controls and access rights to take corrective actions in contingency situations.

Adapted State – Process Controls

In view of compliance with CSDR Level 2 Article 86(2)¹³⁷ of the Regulatory Technical Standards (RTS) on CSD Requirements (ESMA/2015/1457/Annex II), KDD plans to define a Case 2 Restriction Type (“C202”; intraday restriction) in order to block settlement on a security:

- Settlement instructions on the ISIN(s) subject to restriction will be pending for settlement while the blocking applies

Cross-CSD Impact Analysis

Impact on Investor CSD account configuration

The restriction rule “C202” does not rely on account configuration parameters and does not involve account segregation, therefore no impact is foreseen on Investor CSDs' account configuration.

Impact on Investor CSD settlement flows

The restriction rule “C202” would impact cross-CSD transactions involving the restricted security as follows:

- In case of a cross-CSD transaction on a blocked security between a KDD participant and a participant of an Investor CSD, the transaction would not be eligible for settlement while the restriction applies.
- In case of a cross-CSD transaction between Investor CSDs generating realignment movements at KDD, any transaction on the blocked ISIN(s) would not be eligible for settlement while the restriction applies.

However, in case of intra-CSD transactions at an Investor CSD on the ISIN blocked at the Issuer CSD, the intra-CSD transactions at the Investor CSD would not be prevented by the restriction rule “C202” set up at the Issuer CSD. Therefore, the rule will need to be implemented by Investor CSDs in order to ensure compliance with Article 86(2) that requires that all CSDs that are participants of or have an indirect link with the CSD suspending a securities issue for settlement (in accordance with Article 65(2)), including in the case of interoperable links, shall subsequently suspend the securities issue for settlement.

4.15.7 OeKB CSD

Pre T2S – Process Controls

Prior to T2S, OeKB CSD's operations run on a proprietary platform and IT and operational teams have the adequate controls and access rights to take corrective actions in contingency situations.

¹³⁷ “Where a CSD suspends a securities issue for settlement in accordance with Article 65(2), all CSDs that are participants of or have an indirect link with that CSD, including in the case of interoperable links, shall subsequently suspend the securities issue for settlement.”

Adapted State – Process Controls

OeKB CSD has defined “R-8”, a Case 2 Restriction Type (intraday restriction), in order to block settlement on a security in contingency situations:

- Settlement instructions on the ISIN(s) subject to restriction will be pending for settlement while the blocking applies, except if sent by OeKB CSD (Instructing Party: OeKB CSD)

Cross-CSD Impact Analysis

Impact on Investor CSD account configuration

The restriction rule “R-8” does not rely on account configuration parameters and the business process does not require segregation of securities positions. No impact on the Investor CSD account configuration has been identified.

Impact on Investor CSD settlement flows

The restriction rule “R-8” would impact cross-CSD transactions involving the restricted security as follows:

- In case of a cross-CSD transaction on a blocked security between an OeKB CSD participant and a participant of an Investor CSD, the transaction would not be eligible for settlement while the restriction applies.
- In case of a cross-CSD transaction between Investor CSDs generating realignment movements at OeKB CSD, any transaction on the blocked ISIN(s) would not be eligible for settlement while the restriction applies.

In practice the impact on settlement flows will be limited because the restriction will only be applied in exceptional situations.

Pending transactions on the ISIN(s) to be deactivated could have to be cancelled, bilaterally with the involvement of Investor CSD(s).

Conclusion

Operational processes and procedures will be put in place by CSDs in order to deal with contingency situations and take corrective actions.

In this context, CBF, ESES, Euroclear Finland, and Iberclear have defined special restriction rules that will allow them to by-pass other restriction rules they have put in place. Such rules will de facto have no impact on Investor CSDs’ settlement flows. These restriction rules could be considered by all CSDs in T2S having defined additional controls in the form of restriction rules, to manage potential contingency situations and/or be able to by-pass specific validations, depending on their operational needs.

CBF has also defined two other restriction rules: one is in the context of the pre-migration to T2S, where T2S actors are granted technical access to the platform, to prevent any settlement until go-

live. This temporary rule could be considered by other CSDs as a safety net (a Case 2 Restriction will also be applied by the T2S Operator on the party CSD).

The other is to reserve the usage of the ISO transaction code CNBC to Central banks. The usage of this code in settlement instructions allows T2S actors to settle DVP transactions with a later cut-off time in the settlement day (17:40 instead of 16:00). The rule will not impact Investor CSDs' settlement flows. Furthermore, as the usage of ISO transaction codes can be restricted with appropriate configuration of access rights, Investor CSDs willing to implement such control do not necessarily need to rely on a restriction rule.

ESES and Iberclear have defined restriction rules in order to block settlement instructions on an ISIN, to handle fractional digit changes¹³⁸, which do not take place in the context of a Corporate Action. The handling of such residual cases is subject to discussion for inclusion in the MOP.

Iberclear has also defined restriction rules to block settlement at ISIN, securities account, or party level in contingency situations. Depending on the situation, the blocking may need to be activated by Investor CSDs.

Three other CSDs have also defined restriction rules to block settlement at ISIN level. For Baltic CSDs and OeKB CSD, it is defined for generic purposes to handle contingency situations. For KDD, it is planned in the event of reconciliation errors as per requirement of the CSDR Level 2, in Article 86(2) of the Draft Regulatory Technical Standards (RTS) on CSD Requirements (ESMA/2015/1457/Annex II), which prescribes Issuer CSDs to stop settlement in such cases. According to the Technical Standard requirement, the blocking also needs to be activated by the Investor CSDs of the Issuer CSD suspending the ISIN. Hence, this restriction rule could be considered by all CSDs in T2S.

¹³⁸ Change of settlement type on a security (unit to face amount or vice versa) or redenomination of a bond where the new currency has a different number of decimals, which are not covered by CR538.

4.16 Static Data Configuration

Introduction

For the assessment of restriction rules according to the methodology defined in Section 2.2 “Methodology to quantify impacts on Investor CSDs”, the process is categorised as optional from an Investor CSD’s standpoint, as it is defined by a(n Issuer) CSD for internal static data management purposes.

CSDs perform specific static data configuration in their internal systems for various reasons such as blocking settlement prior to the deletion of an account, a party or a security, or for setting up specific configurations on accounts according to their domestic account setup specificities.

In T2S, CSDs will setup restriction rules to ensure compliance with their internal systems account setup and prior to the deletion of some static data objects (i.e. parties, securities, accounts).

The description of current services and controls, restrictions rules, and impact analysis by market is detailed in the next sections.

4.16.1 Baltic CSDs

Pre T2S – Process Controls

The management of securities positions are fully handled by the Baltic CSDs (Estonia, Latvia, and Lithuania) in their legacy platforms.

Adapted State – Process Controls

The Baltic CSDs will not allow the usage of settlement restrictions (intra-position movements) by CSD participants, for reservation, blocking, and earmarking of securities positions in T2S.

Accordingly, the Baltic CSDs have created a restriction rule that prevents the usage of settlement restrictions by CSD participants, on all sub-positions, except the “COSP” position type which is necessary for the Conditional Securities Delivery (CoSD) process. This position type is created by the T2S operator.

Positive/Negative Rejection (Case 1 Restriction Type):

BCDR02(A): this restriction rule rejects settlement restrictions on all securities positions sent by CSD participants.

BCDR02(B): this restriction rule creates an exception to the previous rule in order to not reject settlement restrictions generated by T2S on the specific position type used for CoSD (COSP).

The parameters configured in these rules are listed below:

- Credited/Debited position, with value:
 - COSP
- Party Type (of the instructing party), with value:

- CSD Participant

For generic purposes, the Baltic CSDs has also defined a Case 3 Restriction Type for earmarking of securities positions (“EARM (optional)”).

Earmarking (Case 3 Restriction Type):

EARM (optional): has been defined for earmarking securities in a dedicated sub-position (Restriction Type: “earmarking”). This restriction type is currently not planned for a specific process and no restriction rules are linked to this restriction type.

Cross-CSD Impact Analysis

Impact on Investor CSD account configuration

The restriction rules “BCDR02(A)” and “BCDR02(B)” imply that Investor CSDs cannot manage segregation of securities positions within their omnibus account through settlement restrictions, which excludes blocking and reservation as possible restriction types for segregation of securities positions. This requires Investor CSDs to consider a segregation model based on the usage of separate accounts, or earmarking position types, which can be managed through settlement instructions.

As regards the “EARM” position type, earmarking of securities positions in this specific sub-position may apply to the Investor CSDs’ omnibus account held at the Baltic CSDs. Since this segregation is done only upon request of Investor CSDs, it is therefore assumed that in this case the segregation would also be reflected by Investor CSDs on the account of their participants.

Impact on Investor CSD settlement flows

The restriction rules “BCDR02(A)” and “BCDR02(B)” defined by the Baltic CSDs do not need to be implemented by Investor CSDs and will not impact cross-CSD transactions between CSD participants. However, it will not support any business scenario where Investor CSDs would send settlement restrictions directly on their omnibus account at the Baltic CSDs, as these will get rejected.

Investor CSDs opting for earmarking securities positions in the position type “EARM (optional)” have to implement adequate segregation in their books (by position types or separate accounts) to (i) ensure consistency of available securities position (AWAS) between omnibus and participants’ accounts; and (ii) prevent the risk of settlement fail at the level of the omnibus account provision check.

4.16.2 Clearstream Banking Frankfurt (CBF)

Pre T2S – Process Controls

CBF performs certain static data operations prior to the deletion of parties, securities or securities accounts, as blocking settlement on the objects to be deleted. CBF also has some restrictions on specific customers’ securities accounts where settlement against payment is not allowed. Furthermore, some specific sub-positions are not allowed in some securities accounts.

Adapted State – Process Controls

CBF will setup a restriction rule in order to reject (Case 1 Restriction Type):

- Against payment instructions on some account types except when sent by CBF. An MSA is used to define if the securities account is enabled for DVP settlement (*Teilnahme-DVP*).
- Instruction including position types not compatible with the account. An MSA is used to define if an account can in general hold position types other than AWAS (Position-Type).

CBF has defined restriction rules in order to block (Case 2 Restriction Type) parties, securities or securities accounts prior to deletion, allowing only CBF to instruct on the blocked static data object.

Rejection (Restriction case 1)

“Party and account configuration- Reject” – rejects settlement instructions on securities accounts not allowing DVP instructions or not supporting certain sub-position types.

The parameters configured in the rules are listed below:

- Payment type code:
 - Against payment
- “Teilnahme-DVP” (Market-specific attribute on securities accounts)
- “Position-Type” (Market-specific attribute on securities accounts)
- Debited/Credited position/balance: AWAS, EEUR, EXXX, RSHB, RSKE
- Instructing Party: CBF’s BIC code

Blocking (Restriction case 2)

“Security Blocking” – blocks settlement of a specific ISIN except for instructions sent by CBF or any of the authorised actors (STORNO BIC).

“Party Blocking” – blocks settlement of instructions by a given party.

“Account Blocking” – blocks settlement on specific securities account except for instructions sent by CBF or any of the authorised actors (STORNO BIC).

Cross-CSD Impact Analysis

Impact on Investor CSD account configuration

Unless requested by an Investor CSD, restrictions on securities account will not apply to omnibus accounts. If requested, the Investor CSD can choose to segregate by separate accounts or by sub-positions within an account.

Impact on Investor CSD settlement flows

Restriction rules defined by CBF in the context of static data configuration should only be implemented by Investor CSDs if such controls are required for intra-CSD transactions.

The restriction rule “Party and account configuration – Reject” will not have any impact on realignment instructions, since these are free of payment and do not debit or credit any position type, so the restriction rule would not be matched at the level of realignment instructions. This also means that such control is not suited for cross-CSD activity and would need to be implemented by Investor CSDs in case the same restrictions (prevent DVP transactions) are required for intra-CSD transactions.

In case of a cross-CSD scenario between a participant of CBF and a participant of an Investor CSD, if the participant account included in the Business Instruction sent by the CBF participant is not compatible with the position types referenced in the instruction or is not enabled for DVP settlement, the Business Instruction of the CBF participant would be rejected and the Business Instruction of the Investor CSD level would remain unmatched.

Restriction rules “Security Blocking”, “Party Blocking” and “Account Blocking”, in the context of static data configuration, have little potential impacts on Investor CSDs’ settlement flows, as they would be applied prior to the deletion of the static data object. The volume of pending instructions in T2S on the objects to be deleted should be minimal. Below is a description of the theoretical impacts on cross-border transaction involving the blocked party, account or security:

- In case of a cross-CSD transaction on a blocked static data object (account, party, or security) between a CBF participant and a participant of an Investor CSD, the transaction would not be eligible for settlement while the blocking applies.
- In case of a cross-CSD transaction between Investor CSDs generating realignment movements at CBF:
 - For “Party Blocking”, “Account Blocking”, in the specific case where the account is owned by an Investor CSD or the party being blocked is one of the Investor CSDs, the transaction would not be eligible for settlement while the restriction applies.
 - For “Security Blocking”, any the transaction on the blocked ISIN would not be eligible for settlement while the restriction applies.

4.16.3 KDD

Pre T2S – Process Controls

In KDD segregation of securities positions is used to record Third Party Rights (pledge, pre-emption rights, court/tax authority orders, etc.), and this is done using subaccounts within the main accounts of participants or end-investors. Third Party Rights represent a kind of blocking of securities positions in KDD’s system.

Adapted State – Process Controls

With migration to T2S, KDD will keep the functionality for recording Third Party Rights in its own system, because it fully reflects the needs of its market participants. Therefore, KDD will not allow the usage of settlement restrictions (intra-position movements) by CSD participants, for reservation, blocking

and earmarking of securities positions in T2S. For auto-collateralisation, earmarking will be done at securities account level and settlement instructions will be used.

Accordingly, KDD has created a restriction rule that prevents the use of settlement restrictions by CSD participants, on all sub-positions, except the 'COSP' position type which is necessary for the Conditional Securities Delivery (CoSD) process. This position type is created by the T2S operator:

Positive /Negative Rejection (Case 1 Restriction Type)

C101: this restriction rule rejects settlement restrictions on all securities positions sent by CSD participants. Earmarking for auto-collateralisation will instead be possible through settlement instructions (as described above).

C102: this restriction rule creates an exception to the previous rule in order not to reject settlement restrictions generated by T2S on the specific position type used for CoSD (COSP).

The parameters configured in the rules are listed below:

- Party type of the instructing party:
 - CSD Participant
- Debited/Credited position:
 - 'COSP'

Cross-CSD Impact Analysis

Impact on Investor CSD account configuration

The restriction rules C101/C102 imply that Investor CSDs cannot manage segregation of securities positions within their omnibus account through settlement restrictions, which excludes blocking and reservation as possible restriction types for segregation of securities positions. This requires Investor CSDs to consider a segregation model based on the use of separate accounts, or earmarking position types, which can be managed through settlement instructions.

Impact on Investor CSD settlement flows

The restriction rules C101/C102 defined by KDD do not need to be implemented by Investor CSDs and will not impact cross-CSD transactions between CSD participants. However, it will not support any business scenario where Investor CSDs would send settlement restrictions directly on their omnibus account at KDD, as these will get rejected.

4.16.4ESES (Euroclear Belgium, Euroclear France, Euroclear Netherlands)

Pre T2S – Process Controls

In the legacy platform of ESES, segregation of securities positions is based on two levels of securities sub-positions within securities accounts:

- The Account Nature, which refers to business / legal purpose of the position (eg. Registered, bearer, specific CA purpose)
- The Collateral Indicator (ICPG), which segregates securities eligible as collateral

ESES has in place some controls aimed at ensuring the compatibility of accounts (Account Nature) with certain securities which are classified according to the holding mode, category or legal form.

Adapted State – Process Controls

In T2S, ESES will adapt its segregation model in the T2S static data from a model based on securities sub-positions to a model based on segregation at securities account level. A market specific attribute on securities account is used to specify the Account Nature. The below Account Natures are assigned by ESES to accounts owned by Investor CSDs for their activity:

- Ordinary securities (000)
- Administered registered securities (001) if needed for handling registered shares

ESES will set up in the T2S static data restriction rules to ensure the compatibility of the Account Nature (MSA on securities account) with the security (MSA on securities). Securities are classified by ESES in the T2S static data through market specific attributes on securities according to different criteria as the security category, security holding mode and the legal form of the security. Some of these validations do not refer to a specific business process, therefore the related restriction rules have been assigned to static data configuration.

Furthermore, ESES will only allow CSD participants to earmark securities for auto-collateralisation through the position type “EXXX”, earmarking for auto-collateralisation for all currencies, rather than “EEUR”, which is specific to Euro.

Rejection (Restriction case 1)

RT04 (ESE-013-SDC) – rejects settlement instructions debiting or crediting the “EEUR” position type.

The rationale is that ESES only allows earmarking for auto-collateralisation through the “EXXX” position type. The “EEUR” and “EXXX” position types will be created by the T2S Operator.

Note: This restriction rule is currently considered in the static data configuration business process as there is no functional restriction to the T2S functionality, the only settlement currency in T2S for the first release being Euro. This rule would have to be reassessed and reallocated when other currencies become eligible.

RT06 (ESE-028-SDC) - rejects settlement instructions on 'dematerialised securities or not admitted in ESES ' or securities for which the legal form is 'Bearer or registered' on account nature 'Physical securities with unknown owner'.

The parameters configured in the rules are listed below:

- Account nature (MSA on securities accounts):

- Physical securities with unknown owner' (094)
- Holding mode (MSA on securities):
 - 'dematerialised securities or not admitted in ESES' (9)
- Legal form (MSA on securities):
 - 'Bearer or registered' (0)

RT07 (ESE-030-SDC) – rejects settlement instructions on securities with a legal form not supported on broker trading accounts.

The parameters configured in the rules are listed below:

- Account nature (MSA on securities accounts):
 - 'Broker trading accounts' (010)
- Legal form (MSA on securities):
 - 'Bearer or registered' (0)
 - 'Bearer' (3)
 - 'Securities deposited in EBE or ENL (domestic or foreign)' (7)

Note: The instructions are not rejected if the instructing party is a CSD. This allows “Ex-nominatives” securities to be moved from Account Nature 010. A control is performed in ESES to avoid wrong legal form to be processed.

RT11 (ESE-054-SDC) – rejects settlement instructions sent by CSD participants on various Account Natures (080, 086,104, 107,109, 110) which are reserved for specific purposes. In the case of Account Nature 080, it is only the delivering account in case of delivering settlement instructions, and the receiving account in case of receiving settlement instructions that triggers the rejection.

The parameters configured in the rules are listed below:

- Account nature (MSA on securities accounts):
 - 'Foreign securities held by another CSD (foreign organisation or foreign custodian)' (080)
 - 'Securities that have been blocked for specific setup or specific purposes' (086)
 - 'Specific NOMS for Belgian registered securities' (104)
 - 'Blocked securities' (107)
 - 'Pivot account for CA' (109)
 - 'Securities reserved upon a corporate action elective instruction' (110)
- Instructing Party Type:
 - CSD participant
- Securities Movement Type

- 'DELI', 'RECE'

Furthermore, ESES will not allow the usage of settlement restrictions (intra-position movements), neither by CSD participants or by the different ESES CSDs, as no functional use of restriction was identified for current ESES processes. Nevertheless, ESES will allow the credit and debit of T2S securities sub-positions to indicate whether securities are eligible as collateral (e.g. transfer from 'AWAS' to 'EXXX') using already matched instructions.

Accordingly, ESES has created a restriction rule that prevents the use of settlement restrictions by any ESES party, including ESES CSDs, on all sub-positions, except the 'COSP' position type necessary for the Conditional Securities Delivery (CoSD) process. This position type is created by the T2S operator.

Positive /Negative Rejection (Case 1 Restriction Type)

RT1A (ESE-045-SDC): this restriction rule rejects settlement restrictions on all securities positions sent by any party, including ESES. Earmarking for auto-collateralisation will instead be possible through settlement instructions (as described above).

RT10 (ESE-057-SDC): this restriction rule creates an exception to the previous rule in order not to reject settlement restrictions generated by T2S on the specific position type used for CoSD (COSP)

The parameters configured in the rules are listed below:

- Party type of the instructing party:
 - CSD Participant, CSD, External CSD
- Debited/Credited position:
 - 'COSP'

Cross-CSD Impact Analysis

Impact on Investor CSD account configuration

No impact on the investor CSD account configuration has been identified for the following restriction rules of ESES related to static data configuration:

- The rule RT04 (ESE-013-SDC) relies on account configuration parameters which are internal to ESES
- For the rules RT06 (ESE-028-SDC) and RT07 (ESE-030-SDC), and RT11 (ESE-054-SDC), none of the Account Natures triggering the rejection are available to Investor CSDs.

In the case of RT1A / RT10, the identified impact would be that Investor CSDs cannot manage segregation of securities positions within their omnibus account through settlement restrictions, which excludes blocking and reservation as possible restriction types for segregation of securities positions. This requires Investor CSDs to consider a segregation model based on the use of separate accounts, or earmarking position types, which can be managed through settlement instructions.

Impact on Investor CSD settlement flows

The below Account Natures are assigned by ESES CSDs to accounts owned by Investor CSDs for their activity:

- Ordinary securities (000)
- Administered registered securities (001) if needed for handling registered securities

For the following restriction rules analysed under this section, RT04 (ESE-013-SDC), RT06 (ESE-028-SDC), RT07 (ESE-030-SDC), and RT11 (ESE-054-SDC) do not need to be implemented by Investor CSDs, as none of the Account Natures subject to rejection are available to Investor CSDs:

- In case of a cross-CSD scenario between a participant of ESES and a participant of an Investor CSD, the Business Instruction of the ESES participant triggering the restriction rule would be rejected and the counterpart Business Instruction at the Investor CSD level would remain unmatched
- In case of a cross-CSD scenario involving realignments at ESES (between two investor CSDs or ESES and an Investor CSD), the realignment instructions will not be impacted by the rule and the transaction can be eligible to settle.

The restriction rules RT1A/RT10 defined by ESES do not need to be implemented by Investor CSDs and will not impact cross-CSD transactions between CSD participants. However, it will not support any business scenario where Investor CSDs would send settlement restrictions directly on their omnibus account at ESES CSDs, as these will get rejected.

4.16.5 Euroclear Finland

Pre T2S – Process Controls

Euroclear Finland maintains specific statuses in its legacy system static data model for the management of securities accounts and parties. Such statuses are applied upon closing of the relevant static data object and validation rules prevent acceptance of settlement instructions on these objects while in this closing process takes place.

In addition, the management of securities positions are fully handled by Euroclear Finland in its legacy system.

Adapted State – Process Controls

Euroclear Finland has decided to mirror some statuses present in its legacy system and the related validation rules in T2S for the management of securities accounts and parties.

For this purpose, Euroclear Finland has defined restriction rules in order to reject (Case 1 Restriction Type) new incoming settlement instructions on securities accounts or sent by parties that have specific statuses upon closing of the relevant static data object. MSAs are used to define the status of securities accounts (ACCOUNTSTATUS), as well as parties (BPSTATUS).

Rejection (Case 1 Restriction Type):

“PSUS (B)” - rejects settlement instructions on parties with status “To Be Deleted”.

The parameter configured in this rule is listed below:

- “BPSTATUS” (MSA on party level), with the following non-exhaustive list of values:
 - To Be Deleted (prior to deletion of the party)

“ASTS (C)” - rejects settlement instructions on securities accounts with status “To be Deleted”.

The parameter configured in this rule is listed below:

- “ACCOUNTSTATUS” (MSA on securities accounts), with the following non-exhaustive list of values:
 - To be Deleted (prior to deletion of the account)

Furthermore, Euroclear Finland will not allow the reservation, blocking, and earmarking of securities positions in T2S through settlement restrictions (intra-position movements). The management of securities positions will be fully handled by Euroclear Finland. Consequently, Euroclear Finland has created a restriction rule that prevents the usage of settlement restrictions by CSD participants and External CSDs, on all sub-positions, except the “COSP” position type which is necessary for the Conditional Securities Delivery (CoSD) process. This position type is created by the T2S operator.

Positive/Negative Rejection (Case 1 Restriction Type):

RESP: this restriction rule rejects settlement restrictions on all securities positions sent by CSD participants and External CSDs.

RESN: this restriction rule creates an exception to the previous rule in order to not reject settlement restrictions generated by T2S on the specific position type used for CoSD (COSP).

The parameters configured in these rules are listed below:

- Credited/Debited Position/Balance, with value:
 - COSP
- Party Type (of the instructing party), with value:
 - CSD Participant
 - External CSD

Cross-CSD Impact Analysis

Impact on Investor CSD account configuration

The restriction rule “PSUS (B)”, does not rely on account configuration parameters and the business process does not require segregation of securities positions, while “ASTS (C)” relies on the usage of an MSA defined at securities account level. However, since the statuses triggering rejection are only applied for a short lapse of time at the closing of the securities account, Investor CSDs do not necessarily need to implement this MSA.

The restriction rules “RESP” and “RESN” imply that Investor CSDs cannot manage segregation of securities positions within their omnibus account through settlement restrictions, which excludes blocking and reservation as possible restriction types for segregation of securities positions. This requires Investor CSDs to consider a segregation model based on the usage of separate accounts, or earmarking position types, which can be managed through settlement instructions.

Impact on Investor CSD settlement flows

The restriction rule “PSUS (B)” defined at the level of settlement instruction (object restriction type: settlement instruction) would impact Investor CSDs’ settlement flows as follows, at the closing of a party:

- In case of a cross-CSD transaction between a participant of Euroclear Finland (flagged with the party MSA status “To Be Deleted”) and a participant of an Investor CSD, the Business Instruction sent by the participant of Euroclear Finland would be rejected and the Business Instruction at the Investor CSD level would remain unmatched. No realignment will be triggered for this transaction.
- In other cross-CSD scenarios triggering realignment at Euroclear Finland, where an Investor CSD would be in closing process (flagged with the relevant MSA status on the party), realignment instructions would not be generated and the Business Instructions would be cancelled after acceptance and matching.

The restriction rule “ASTS (C)” defined at the level of settlement instruction (object restriction type: settlement instruction) would impact Investor CSDs’ settlement flows as follows, at the closing of a securities account:

- In case of a cross-CSD transaction between a participant of Euroclear Finland, with a securities account in closing process (flagged with the relevant MSA status on the securities account), and a participant of an Investor CSD, the Business Instruction sent by the participant of Euroclear Finland would be rejected and the Business Instruction at the Investor CSD level would remain unmatched. No realignment will be triggered for this transaction.
- In other cross-CSD scenarios triggering realignment at Euroclear Finland, where an Investor CSD would use a securities account in closing process (flagged with the relevant MSA status on the securities account), realignment instructions would not be generated and the Business Instructions would be cancelled after acceptance and matching.

To conclude, the restriction rules implemented by Euroclear Finland to mirror the internal statuses of its legacy system at the closing of a securities account or party may impact Investor CSDs’ settlement flows in these lapses of time, but do not necessarily need to be implemented by Investor CSDs. Instead, Investor CSDs may rely on T2S standard validations, and must ensure that those market-specific statuses applied by Euroclear Finland are in line with the validity dates of these objects in T2S.

The restriction rules “RESP” and “RESN” defined by Euroclear Finland do not need to be implemented by Investor CSDs and will not impact cross-CSD transactions between CSD participants. However, it will

not support any business scenario where Investor CSDs would send settlement restrictions directly on their omnibus account at Euroclear Finland, as these will get rejected.

4.16.6 Iberclear

Pre T2S – Process Controls

Iberclear currently allows its clients to segregate their own positions within their securities accounts. Furthermore, some activities are exclusively managed by Iberclear, such as certain collateral and pledge operations, immobilisation of securities in the register, etc...

Adapted State – Process Controls

For generic purposes, Iberclear has defined Case 3 Restriction Types for earmarking of securities positions (“AS01”, “AS02”, and “AS03”).

Earmarking (Case 3 Restriction Type)

“AS01”, “AS02”, and “AS03” have been defined for earmarking securities in a dedicated sub-position (Restriction Type: “earmarking”). These restriction types are currently not planned for a specific process and no restriction rules are linked to those restriction types.

Positive and negative rejection rules (Case 1 Restriction Type)

Iberclear has also defined Case 1 Restriction Type rules for rejecting settlement instructions sent by a DCP on securities accounts (defined with MSA) which can only be instructed by Iberclear, unless they are T2S Generated realignment or auto-collateralisation instructions.

These restriction types are applicable to securities accounts used exclusively for indirect activities regarding collateral management, immobilisation of securities in the register, certain securities pledges and financial collateral arrangements, omnibus accounts of Investor CSDs.

Access rights will be used to prevent the usage of these accounts by DCPs, therefore the restriction rules below will only be triggered until the access rights have been setup.

- “RPOI”: a positive rejection rule (Case 1 Restriction Type). The rule is defined to restrict the usage of securities accounts which are restricted for use by DCPs (defined with MSA) while privileges are being set up on those accounts, and can only be instructed by Iberclear.
- “RNOI”: a negative rejection rule (Case 1 Restriction Type). The rule will be used in this context to bypass the validation defined in the rule “RPOI” when settlement instructions are sent with ISO transaction code “REAL”, “COLI”, or “COLO”, for a subset of those securities accounts triggering the “RPOI” rejection.

- “IBR1”: a negative rejection rule (Case 1 Restriction Type). The rule will be used in this context to bypass the validation defined in the rule “RPOI” when settlement instructions are sent by Iberclear.

The parameters configured in the rules are listed below:

IBR1:

- Instructing Party Type, with the value:
 - CSD

RPOI:

- “Account Type”, an MSA on securities account level to define which MSA securities account values will trigger the rejection of a settlement instruction, e.g.: “POEXCA” (please consult Iberclear for the full list)

RNOI:

- Transaction Identification (ISO transaction code), with the value:
 - COLI, COLO, REAL
- “Account Type”, an MSA on securities account level to define which MSA securities account values will not trigger the rejection of a settlement instruction (if also instructed with one of the above ISO transaction codes), e.g.: “POEXCP” (please consult Iberclear for the full list)

Cross-CSD Impact Analysis

Impact on Investor CSD account configuration

Upon request of an Investor CSD, segregation of securities positions in the position types “AS01”, “AS02”, and/or “AS03” may apply to its omnibus account held in Iberclear. It is therefore assumed that in this case the segregation would also be reflected by the Investor CSD on the account of its participants.

The restriction rules “RNOI” and “RPOI” will also apply to Investor CSDs’ omnibus accounts to prevent them to instruct directly on their account(s), and it is in the remit of each CSD in its role as Issuer CSD to decide whether to allow Investor CSDs to instruct directly on their omnibus account(s) in T2S and implement similar controls.

Impact on Investor CSD settlement flows

Upon request of an Investor CSD, the position types “AS01”, “AS02”, and “AS03” could be applied to the Investor CSD’s omnibus account held in Iberclear. Investor CSDs opting for this segregation have to implement adequate segregation in their books (by position types or separate accounts) in order to ensure

consistency of available securities position (AWAS) between omnibus and participants' accounts and prevent the risk of settlement fail at the level of the omnibus account provision check.

Restriction rules "RNOI" and "RPOI" will prevent Investor CSDs to send settlement instructions directly on their omnibus accounts. The rules do not necessarily need to be implemented by Investor CSDs, as it will be the decision of each CSD in its role as Issuer CSD to decide whether to allow direct access on the omnibus account(s) from Investor CSDs. The restriction rules have been configured to allow realignment instructions, and therefore would not impact regular cross-CSD transactions:

- In case of a cross-CSD scenario between a DCP participant of Iberclear and a participant of an Investor CSD where the settlement instruction was wrongly sent on an "ICP securities account" by a DCP, the Business Instruction of the Iberclear participant triggering the restriction rule would be rejected and the counterpart Business Instruction at the Investor CSD level would remain unmatched
- In other cross-CSD scenarios generating realignment movements at Iberclear, the rejection will not be triggered and the transaction can be eligible for settlement.

4.16.7 Interbolsa

Pre T2S – Process Controls

Interbolsa uses "situations", which are position types to segregate and restrict securities sub-positions from settlement.

Adapted State – Process Controls

For generic purposes, Interbolsa has defined in the T2S Static Data a Case 3 Restriction Type for blocking of securities positions for purposes other than judicial blocking ("BL09"), and for settlement management. ("BL11")

For settlement management, Interbolsa has defined a Case 3 Restriction Type for earmarking ("EA40") and reservation ("RE35") of securities sub-positions.

Blocking (Case 3 Restriction Type)

"BL09": Blocks securities in a dedicated sub-position. This restriction type is currently not planned for a specific process.

"BL11": Blocks securities in a dedicated sub-position.

"RE35": Reserves securities in a dedicated sub-position type for settlement management.

"EA40": Earmarks securities in a dedicated sub-position type for settlement management.

Rejection (Case 3 Restriction Type)

"SR03": rejects settlement instructions on specific position types (i.e. "BL09"), that only Interbolsa can debit.

The parameters configured in the rules are listed below:

- Party type of the instructing party:
 - CSD participant
- Debited position:
 - BL09¹³⁹

Cross-CSD Impact Analysis

Impact on Investor CSD account configuration

The position types “BL09”, “BL11”, “RE35” and “EA40” will only apply to Investor CSDs’ omnibus accounts on their request. In such case, Investor CSDs need to implement segregation of securities positions in their books.

Impact on Investor CSD settlement flows

The position types “BL09”, “BL11”, “RE35”, and “EA40”, and the rejection rule “SR03”, restricting access to the sub-position (for “BL09” only) would only apply to Investor CSDs’ omnibus accounts on their request. The restriction rule will not have a direct impact on trade-related cross-border instructions, as realignment instructions would not make use of the restricted positions; i.e. realignment instructions would not match the restriction rules. Investor CSDs opting for this segregation have to implement adequate segregation in their books (by position types or separate accounts) in order to ensure consistency of available securities position (AWAS) between omnibus and participants’ accounts and prevent the risk of settlement fail at the level of the omnibus account provision check.

4.16.8 KELER

Pre T2S – Process Controls

KELER maintains specific statuses in its legacy system static data model for the management of securities accounts and parties. Such statuses are applied upon opening or closing of the relevant static data object and validation rules prevent acceptance of settlement instructions on these objects while this opening or closing process takes place.

Adapted State – Process Controls

KELER has decided to mirror some statuses present in its legacy system and the related validation rules in T2S for the management of securities accounts, parties, and securities.

For this purpose, KELER has defined restriction rules in order to reject (Case 1 Restriction Type) new incoming settlement instructions and restrictions on securities accounts or sent by parties that have specific statuses upon opening or closing of the relevant static data object. MSAs are used to define the status of securities accounts (Account status), as well as parties (Party Status).

Rejection (Case 1 Restriction Type)

¹³⁹ For sub-positions “BL11”, “RE35” and “EA40”, there is no restriction rule limiting access to these positions

“RT01_Party_Reject” - rejects settlement instructions and settlement restrictions sent by CSD participants with specific statuses different than “Active”.

The parameters configured in the rules are listed below:

- “Party status” (MSA on party level), with the following non-exhaustive list of values:
 - In Capture (at the opening of the party, prior to allowing transactions for that party)
 - To be deleted (prior to deletion of the party)
 - Deleted (at deletion of the party)
- Transaction identification (ISO transaction code):
 - CORP

“RT03_Account_Reject” - rejects settlement instructions and settlement restrictions on securities accounts with specific statuses different than “Active”.

The parameters configured in the rules are listed below:

- “Account status” (MSA on securities accounts), with the following non-exhaustive list of values:
 - In Capture (at the opening of the account, prior to allowing transactions on the account)
 - To be deleted (prior to deletion of the account)
 - Deleted (at deletion of the account)
- Transaction identification (ISO transaction code):
 - CORP

Cross-CSD Impact Analysis

Impact on Investor CSD account configuration

The restriction rule “RT01_Party_Reject”, does not rely on account configuration parameters and the business process does not require segregation of securities positions, while “RT03_Account_Reject” relies on the usage of an MSA defined at securities account level. However, since the statuses triggering rejection are only applied for a short lapse of time at the opening or closing of the securities account, Investor CSDs do not necessarily need to implement those MSAs.

Impact on Investor CSD settlement flows

The restriction rule “RT01_Party_Reject” defined at the level of settlement instruction (object restriction type: settlement instruction) would impact Investor CSDs’ settlement flows as follows, at the opening or closing of a party:

- In case of a cross-CSD transaction between a participant of KELER in opening / closing process (as flagged with the relevant MSA status on the party) and a participant of an Investor CSD, the Business Instruction sent by the participant of KELER would be rejected and the Business Instruction at the Investor CSD level would remain unmatched. No realignment will be triggered for this transaction.

- In other cross-CSD scenarios triggering realignment at KELER, where an Investor CSD would be in opening / closing process (flagged with the relevant MSA status on the party), realignment instructions would not be generated and the Business Instructions would be cancelled after acceptance and matching.

The restriction rule “RT01_Party_Reject” defined at the level of settlement restriction (object restriction type: settlement restriction) will not impact Investor CSDs’ settlement flows, except in the special scenario where an Investor CSD would instruct an intra-position movement directly on its omnibus account.

The restriction rule “RT03_Account_Reject” defined at the level of settlement instruction (object restriction type: settlement instruction) would impact Investor CSDs’ settlement flows as follows, at the opening or closing of a securities account:

- In case of a cross-CSD transaction between a participant of KELER, with a securities account in opening / closing process (flagged with the relevant MSA status on the securities account), and a participant of an Investor CSD, the Business Instruction sent by the participant of KELER would be rejected and the Business Instruction at the Investor CSD level would remain unmatched. No realignment will be triggered for this transaction.
- In other cross-CSD scenarios triggering realignment at KELER, where an Investor CSD would use a securities account in opening / closing process (flagged with the relevant MSA status on the securities account), realignment instructions would not be generated and the Business Instructions would be cancelled after acceptance and matching.

The restriction rule “RT01_Party_Reject” defined at the level of settlement restriction (object restriction type: settlement restriction) will not impact Investor CSDs’ settlement flows, except in the special scenario where an Investor CSD would instruct an intra-position movement directly on its omnibus account.

To conclude, the restriction rules implemented by KELER to mirror the internal statuses of its legacy system at the opening or closing of a securities account or party may impact Investor CSDs’ settlement flows in these lapses of time, but do not necessarily need to be implemented by Investor CSDs. Instead, Investor CSDs may rely on T2S standard validations, and must ensure that those market-specific statuses applied by KELER are in line with the validity dates of these objects in T2S.

4.16.9 Monte Titoli

Pre T2S – Process Controls

Monte Titoli currently allows its clients to block their own positions within their securities accounts.

Adapted State – Process Controls

Monte Titoli will allow its participants to create securities sub-positions in T2S. The type of sub-positions available to Monte Titoli clients will be extended in T2S to other types besides blocking. Monte Titoli has

defined in the T2S a restriction type case 3 for blocking (“BLK1”), earmarking (“EAR1”), and reservation (“RES1”) of securities sub-positions by CSD participants. This service will be available to Investor CSDs upon request.

Blocking (Restriction case 3)

“BLK1”: blocks securities in a dedicated securities position. This restriction type is currently not planned for a specific process.

Earmarking (Restriction case 3)

“EAR1”: earmarks securities in a dedicated securities position. This restriction type is currently not planned for a specific process.

Reservation (Restriction case 3)

“RES1”: reserves securities in a dedicated securities position. This restriction type is currently not planned for a specific process.

Cross-CSD Impact Analysis

Impact on Investor CSD account configuration

Upon request of an Investor CSD, the position types defined by Monte Titoli “BLK1”, “EAR1” and “RES1” may apply to the Investor CSD’s omnibus account held in Monte Titoli, and subsequently require segregation of securities positions in the Investor CSD participants’ accounts.

Impact on Investor CSD settlement flows

Upon request of an Investor CSD, the position types “BLK1”, “EAR1” and “RES1” could be applied to the Investor CSD’s omnibus account held in Monte Titoli. Investor CSDs opting for this segregation have to implement adequate segregation in their books (by position types or separate accounts) in order to ensure consistency of available securities position (AWAS) between omnibus and participants’ accounts and prevent the risk of settlement fail at the level of the omnibus account provision check.

4.16.10 OeKB CSD

Pre T2S – Process Controls

OeKB CSD prevents settlement of new transactions on security codes which have reached their maturity or are to be deactivated.

Adapted State – Process Controls

OeKB CSD has defined the restriction rule “R-6” (based on a Case 2 Restriction Type), in order to block settlement on a security prior to its deactivation. The rule covers the cases where the maturity date of a

security is not known in advance¹⁴⁰, and is set on short notice so that an update in T2S is not possible anymore (the actual maturity date has already been reached) hence the need for a restriction:

- Settlement instructions on the ISIN(s) subject to restriction will be pending for settlement while the blocking applies, except if instructed by OeKB CSD (Instructing Party)

The parameters configured in the rules are listed below:

- Instructing Party:
 - OeKB CSD (BIC)

Cross-CSD Impact Analysis

Impact on Investor CSD account configuration

The restriction rule “R-6” does not rely on account configuration parameters and the business process does not require segregation of securities positions. No impact on the Investor CSD account configuration has been identified.

Impact on Investor CSD settlement flows

The restriction rule “R-6”, in the context of static data configuration would impact cross-CSD transactions involving the restricted security as follows:

- In case of a cross-CSD transaction on a blocked security between an OeKB CSD participant and a participant of an Investor CSD, the transaction would not be eligible for settlement while the restriction applies.
- In case of a cross-CSD transaction between Investor CSDs generating realignment movements at OeKB CSD, any transaction on the blocked ISIN(s) would not be eligible for settlement while the restriction applies.

In practice the impact on settlement flows will be limited because the restriction will only be applied in the few cases where the maturity date of an ISIN is communicated on or after the actual maturity date. In such cases, the blocking would also need to be applied by Investor CSDs of OeKB CSD, but they would be notified via a coporate action notification message.

Conclusion

CSDs will put in place restriction rules related to static data configuration to support their operational model, or to provide further flexibility to participants in the choice of segregation of securities positions.

In the cases of Baltic CSDs, ESES, Euroclear Finland, and KDD, restriction rules have been defined to reduce the scope of functionalities in T2S as regards the management of securities sub-positions. More precisely, the CSDs restrict the usage of settlement restrictions (intra-position

¹⁴⁰ E.g. shares, open-ended certificates, perpetual bonds,...

movements within an account). This reduces the possibilities for Investor CSDs to manage segregation by position types (only earmarked position types can be debited and credited through settlement instructions).

ESES has also defined restriction rules to ensure the compatibility between account types (Account Nature) and securities characteristics (Security Legal Form, Security Holding Mode). Some of these validations do not refer to a specific business process, hence their classification as static data validations. Another restriction rule defined by ESES controls the position type used for earmarking for auto-collateralisation. In all cases, no impact on Investor CSDs has been identified and the restriction rules shall not be replicated.

Euroclear Finland and KELER have defined restriction rules to mirror in T2S specific statuses present in their legacy systems static data model, which are needed for the management of securities accounts and parties. These restriction rules prevent the acceptance of settlement instructions on these objects during the opening and/or closing process. Investor CSDs do not necessarily need to implement those restriction rules and MSAs. Instead, they may rely on T2S standard validations, provided that those market-specific statuses applied by Euroclear Finland and KELER are in line with the validity dates of the objects in T2S.

Clearstream has defined restriction rules in order to block the activity of a client, an account or a security prior to its deletion, and to adapt the account setup in T2S according to their current account configuration. Impact on Investor CSDs can be considered negligible.

Finally, Baltic CSDs, Iberclear, Interbolsa, and Monte Titoli have created restriction types and in the case of Interbolsa also restriction rules based on the creation of securities sub-positions within securities accounts. In the case where Investor CSDs request the segregation of securities positions in omnibus accounts, they would need to implement segregation in their books to ensure consistency of available securities position between omnibus and participants' accounts.

5. Appendix

5.1 Assessment of restriction rules as per methodology

Id	Business Process	CSD	Control/Restriction rule description ¹⁴¹				Impact Assessment				Additional comments
			Name	Object restriction type	Restriction processing type	Description of the control	Criterion 1 Character of the service / process	Criterion 2 Effort of implementing controls in Investor CSD's structure	Criterion 3 Risk of <u>not</u> implementing controls in Investor CSD's structure	Status	
1	Collateral Management	BOGS	RT01 + RT02	Settlement Instruction	CSD Validation Hold (CVAL)	Settlement instructions from DCPs (identified with MSA) on specific securities used for liquidity purposes by domestic participants must be held on a specific account type (identified with MSA, 502), and settlement instructions are put on CVAL, unless instructed with specific ISO transaction codes (i.e. REPU, etc...)	Optional: Collateral management services are categorised as optional	High: The control is based on the implementation of MSAs therefore the impact is high	Low: Deliveries to Investor CSDs' participants could be put on CVAL hold but will never be cancelled.		The securities remain available to Investor CSDs, although they cannot use them for credit operations with BoG
2	External Cash Settlement	BOGS	RT03	Settlement Instruction	CSD Validation Hold (CVAL)	For some domestic participants where BoG provides the service of a Payment Bank, the settlement instruction is put on hold (CVAL) for BOGS to perform additional validations, and either release or cancel the instruction.	Optional: Banking services are considered as optional	Not available: Investor CSDs cannot benefit from the service provided by BoG			
3	External Cash Settlement	BOGS	RT04	Settlement Instruction	CoSD Hold	For some domestic participants where BoG provides the service of a Payment Bank, the securities delivery leg is	Optional: Banking services are considered as optional	Not available: Investor CSDs cannot benefit from the service provided by BoG			

¹⁴¹ Several restrictions may be grouped for the purpose of the assessment, when they logically form a single control, e.g. a rejection on a specific sub-position, or a negative/positive parameter set

Id	Business Process	CSD	Control/Restriction rule description ¹⁴¹				Impact Assessment				Additional comments
			Name	Object restriction type	Restriction processing type	Description of the control	Criterion 1 Character of the service / process	Criterion 2 Effort of implementing controls in Investor CSD's structure	Criterion 3 Risk of <u>not</u> implementing controls in Investor CSD's structure	Status	
						temporarily blocked in T2S while cash provision is verified by BoG in its internal systems					
4	Insolvency Procedures	BOGS	RT05	Settlement Instruction	CSD Validation Hold (CVAL)	In case of insolvency of a participant, settlement instructions of the suspended CSD participant (party) are put on CVAL	Necessary: The service is necessary according to the definition	High: The control is based on the implementation of MSAs therefore the impact is high	High: Impact is high because potentially not complying with regulatory requirements depending on the scope of the suspension, i.e. if it is applicable in the domestic jurisdiction of the Investor CSD (for intra-CSD transactions when the suspended participant is also participant of the Investor CSD)		
5	Insolvency Procedures	BOGS	RT06	Settlement Instruction	CSD Validation Hold (CVAL)	In case of insolvency that affect specific securities account(s), e.g of a DCA Holder , settlement instructions with this securities account are put on CVAL	Necessary: The service is necessary according to the definition	High: The control is based on the implementation of MSAs therefore the impact is high	High: Impact is high because potentially not complying with regulatory requirements depending on the scope of the suspension, i.e. if it is applicable in the domestic jurisdiction of the Investor CSD (for intra-CSD transactions when the suspended participant is also participant of the Investor CSD)		
6	Other Regulatory Compliance	BOGS	RT07	Settlement Instruction	CSD Validation Hold (CVAL)	Due to capital controls, some free of payment settlement instructions to BOGS' participants may be put on hold for further	Necessary: The service is necessary according to the	Medium: The control is solely based on the implementation of a	Medium: Impact is medium as cross-CSD transactions could be pending and		

Id	Business Process	CSD	Control/Restriction rule description ¹⁴¹				Impact Assessment				Additional comments
			Name	Object restriction type	Restriction processing type	Description of the control	Criterion 1 Character of the service / process	Criterion 2 Effort of implementing controls in Investor CSD's structure	Criterion 3 Risk of not implementing controls in Investor CSD's structure	Status	
						validations.	definition	restriction rule, and this control is not needed as Issuer CSD	require bilateral cancellation of the settlement instructions		
7	Corporate Actions	CDCP	RSE1	Security	Blocking	In accordance with Slovakian law, Issuers may request to block settlement in a specific ISIN up to 5 days prior to a general meeting, with an exception for the transactions stemming from inheritance claims (sent by CDCP)	Necessary: The service is necessary according to the definition.	Low: The control is solely based on the implementation of restriction rules and could be necessary for the activity as Issuer CSD	High: The impact is high as not implementing the control could result in settlement of securities that are restricted from settlement at the Issuer CSD and ownership rights not being exercised.		This restriction can only be applied to non-liquid securities which are not traded on the Stock Exchange. CDCP will open discussion with local regulator (National Bank) and Ministry of Finance and try to force them to remove such option from Slovakian Law.
8	Corporate Actions	CDCP	RSE2	Security	Blocking	In accordance with Slovakian law, Issuers may request to block settlement in a specific ISIN prior to partial/full redemption, or other Corporate Actions, with an exception for the transactions stemming from inheritance claims (sent by CDCP).	Necessary: The service is necessary according to the definition.	Low: The control is solely based on the implementation of restriction rules and could be necessary for the activity as Issuer CSD	High: The impact is high as not implementing the control could result in settlement of securities that are restricted from settlement at the Issuer CSD and ownership rights not being exercised.		The duration of the blocking is decided by the Issuer
9	Limitations due to CSD Legacy Platform	CDCP	CVAL2	Settlement instruction	CSD Validation Hold	Settlement instructions sent by CSD participants (DCPs) are put on CVAL.	Necessary: The service is necessary according to the definition.	Not available: Investor CSDs cannot replicate the controls in their own structure, since the segregation / pledge of the securities is not reflected in T2S			Restrictions on securities positions present in the CSD legacy system are not systematically mirrored in T2S. The rationale is that restrictions on securities positions in the CSD legacy system can overlap (e.g. a security is restricted multiple

Id	Business Process	CSD	Control/Restriction rule description ¹⁴¹				Impact Assessment				Additional comments	
			Name	Object restriction type	Restriction processing type	Description of the control	Criterion 1 Character of the service / process	Criterion 2 Effort of implementing controls in Investor CSD's structure	Criterion 3 Risk of <u>not</u> implementing controls in Investor CSD's structure	Status		
												times), something that cannot be reflected in T2S. CDCP explained that currently they have no DCPs or Investor CSDs and that they may reconsider the process after migration to T2S.
10	Other Regulatory Compliance	CDCP	RSB1	Security	Blocking	Upon decision of a competent national authority, settlement in a specific ISIN must be blocked for a specific period, with an exception for the transactions stemming from inheritance claims (sent by CDCP)	Necessary: The service is necessary according to the definition	Low: The control is solely based on the implementation of restriction rules and could be necessary for the activity as Issuer CSD	High: Impact is high because potentially not complying with regulatory requirements depending on the scope of the suspension, i.e. if it is applicable in the domestic jurisdiction of the Investor CSD			
11	Other Regulatory Compliance	CDCP	RSB2	Security	Blocking	Upon decision of the Oversight body (National Bank of Slovakia), settlement in a specific ISIN must be blocked for a specific period. No exceptions are allowed.	Necessary: The service is necessary according to the definition	Low: The control is solely based on the implementation of restriction rules and could be necessary for the activity as Issuer CSD	High: Impact is high because potentially not complying with regulatory requirements depending on the scope of the suspension, i.e. if it is applicable in the domestic jurisdiction of the Investor CSD			
12	Collateral Management	Clearstream (CBF)	Party and account configuration – REJECT	Settlement Instruction	Rejection	Settlement instructions from CSD participants debiting Eurex Collateral Accounts (identified with MSA) are rejected, unless instructed by CBF or Eurex Clearing	Optional: Collateral management services are categorised as optional	Not available: Investor CSDs cannot open Eurex Collateral Accounts for their participants being/willing to be Clearing Member of				

Id	Business Process	CSD	Control/Restriction rule description ¹⁴¹				Impact Assessment				Additional comments
			Name	Object restriction type	Restriction processing type	Description of the control	Criterion 1 Character of the service / process	Criterion 2 Effort of implementing controls in Investor CSD's structure	Criterion 3 Risk of not implementing controls in Investor CSD's structure	Status	
								Eurex Clearing.			
13	Collateral Management	Clearstream (CBF)	Party and account configuration – CVAL	Settlement Instruction	CSD Validation Hold (CVAL)	Settlement instructions from CSD participants crediting Eurex Collateral Accounts are put on CVAL, for collateral eligibility and valuation checks to be performed by Eurex Clearing	Optional: Collateral management services are categorised as optional	Not available: Investor CSDs cannot open Eurex Collateral Accounts for their participants being/willing to be Clearing Member of Eurex Clearing.			
14	Corporate Actions	Clearstream (CBF)	Security Blocking	Security	Blocking	During the processing of certain Corporate Actions, block all settlement instructions in the concerned ISIN, except if sent using "CORP" ISO transaction code	Necessary: The service is necessary according to the definition	Low: The control is solely based on the implementation of restriction rules and is needed for the activity as Issuer CSD	High: The impact is high as not implementing the control could result in settlement of securities that are restricted from settlement at the Issuer CSD		
15	External Cash Settlement	Clearstream (CBF)	Foreign Currency Settlement - Rejection	Settlement Instruction	Rejection	For securities transactions involving cash settlement in currencies not eligible in T2S, settlement instructions (sent to T2S as FOP) containing a currency which is not accepted by the CSD are rejected	Optional: Cash settlement services in non T2S currencies are considered optional	Not available: Investor CSDs cannot benefit from settlement services in non-T2S currencies provided by the CSD			
16	External Cash Settlement	Clearstream (CBF)	Foreign Currency Settlement - CVAL	Settlement Instruction	CSD Validation Hold (CVAL)	For securities transactions involving cash settlement in currencies not eligible in T2S, settlement instructions (sent to T2S as FOP) containing a currency which is accepted by the CSD are put on CVAL for additional validation checks (cash details)	Optional: Cash settlement services in non T2S currencies are considered optional	Not available: Investor CSDs cannot benefit from settlement services in non-T2S currencies provided by the CSD			
17	External Cash Settlement	Clearstream (CBF)	Foreign Currency Settlement	Settlement Instruction	CoSD Hold	For securities transactions involving cash settlement in currencies not eligible in	Optional: Cash settlement	Not available: Investor CSDs cannot			

Id	Business Process	CSD	Control/Restriction rule description ¹⁴¹				Impact Assessment				Additional comments
			Name	Object restriction type	Restriction processing type	Description of the control	Criterion 1 Character of the service / process	Criterion 2 Effort of implementing controls in Investor CSD's structure	Criterion 3 Risk of not implementing controls in Investor CSD's structure	Status	
			nt - CoSD			T2S (i.e. non T2S settlement currencies accepted by the CSD), the securities delivery leg is temporarily blocked in T2S while cash settlement is performed on an external settlement platform	services in non T2S currencies are considered optional	benefit from settlement services in non-T2S currencies provided by the CSD			
18	External CSD Settlement	Clearstream (CBF)	OUT-CSD Settlement	Settlement Instruction	CoSD Hold	For cross-CSD transactions involving a CSD external to T2S, the securities leg of the transaction is temporarily blocked until an external settlement condition has been fulfilled i.e. cash or securities settlement leg outside T2S	Optional: The service is considered optional as CBF is acting as Investor CSD of an External CSD and not as Issuer CSD, i.e. triggering the CoSD rules only in the case where the Issuer CSD is outside T2S.	Medium: The control is solely based on the implementation of a CoSD rule and is not needed for the activity as Issuer CSD	Medium: Impact is medium as cross-CSD transactions could be pending and require bilateral cancellation of the settlement instructions		
19	Issuance	Clearstream (CBF)	X-Border Settlement - Reject	Settlement Instruction	Rejection	Realignment instructions against issuance accounts are rejected in order to ensure consistency with CBF vaults in the case of multi-issued securities.	Optional: Issuance services are considered optional	High: The control is based on the implementation of MSAs therefore the impact is high	High: Impact is high because transactions involving Investor CSDs could be cancelled after matching.		
20	Issuance	Clearstream (CBF)	Party and account configuration - CVAL	Settlement Instruction	CSD Validation Hold (CVAL)	Access to some specific issuance accounts (identified with MSA) is limited to issuing agents to perform pre-issuance activities. Settlement instructions on such issuance accounts are put on CVAL for CBF to perform additional validations.	Optional: Issuance services are considered optional	High: The control is based on the implementation of MSAs therefore the impact is high	None: Impact is none because the issuance accounts subject to the rule are not held by Investor CSDs and cannot be subject to cross-CSD transactions		

Id	Business Process	CSD	Control/Restriction rule description ¹⁴¹				Impact Assessment				Additional comments
			Name	Object restriction type	Restriction processing type	Description of the control	Criterion 1 Character of the service / process	Criterion 2 Effort of implementing controls in Investor CSD's structure	Criterion 3 Risk of not implementing controls in Investor CSD's structure	Status	
21	Issuance	Clearstream (CBF)	Party and account configuration-CVAL	Settlement Instruction	CSD Validation Hold (CVAL)	Delivering settlement instructions on specific account types (identified with MSA) used for dual global bonds processing are put on CVAL	Optional: Issuance services are considered optional	High: The control is based on the implementation of MSAs therefore the impact is high	None: Impact is none because the transaction will be put on hold (CVAL) will be released almost immediately		The release process is handled STP by CBF and the time the instruction will be put on hold (i.e. a minute) is negligible for Investor CSDs
22	Non-European Regulations	Clearstream (CBF)	TEFRA D-CVAL	Settlement Instruction	CSD Validation Hold (CVAL)	Settlement instructions on TEFRA-D securities (identified with MSA) during the 40 days lockup period are put on CVAL and transferred into a specific account. During this 40 day period, TEFRA-D securities can only be transferred between specific accounts	Optional: Services related to Non-European Regulations put in place to support intermediaries are considered optional	High: The control is based on the implementation of MSAs therefore the impact is high	Low: The impact is low as settlement instructions may be pending without risk of manual cancellation		
23	Non-European Regulations	Clearstream (CBF)	Security Blocking	Security	Blocking	At the end of the 40 days lockup period, settlement instructions on TEFRA-D securities (identified with MSA) are temporarily blocked in order to be transferred to a specific blocking account	Optional: Services related to Non-European Regulations put in place to support intermediaries are considered optional	High: The control is based on the implementation of MSAs therefore the impact is high	Low: The impact is low as settlement instructions may be pending without risk of manual cancellation		
24	Operational Procedures	Clearstream (CBF)	CNCB related rules	Settlement Instruction	Rejection	All settlement instructions with ISO transaction code equal to "CNCB" are rejected, except when instructed by a central bank	Necessary: The process is considered necessary as operational procedures shall be defined by an Issuer CSD to ensure the management of operational risk on the settlement	None: As this control can be implemented by privileges instead of restriction rules, there is no impact	None: As this control can be implemented by privileges instead of restriction rules, there is no impact.		Investor CSDs' instructions will never be impacted by the rule

Id	Business Process	CSD	Control/Restriction rule description ¹⁴¹				Impact Assessment				Additional comments	
			Name	Object restriction type	Restriction processing type	Description of the control	Criterion 1 Character of the service / process	Criterion 2 Effort of implementing controls in Investor CSD's structure	Criterion 3 Risk of <u>not</u> implementing controls in Investor CSD's structure	Status		
							platform for all its participants, including Investor CSDs					
25	Operational Procedures	Clearstream (CBF)	Pre-Migration Rules	Settlement Instruction	Rejection	All settlement instructions from CBF or its participants are rejected	Not assessed	Not assessed	Not assessed			The rule will only be used before live operations in T2S (between pre-migration and implementation date)
26	Operational Procedures	Clearstream (CBF)	Storno - Reject	Settlement Instruction	Rejection	Settlement instructions sent to T2S with the specific "Storno" BIC as Instructing Party (used by Clearstream) will be used to bypass (negative rule) other restriction rules (rejection)	Necessary: The process is considered necessary as operational procedures shall be defined by an Issuer CSD to ensure the management of operational risk on the settlement platform for all its participants, including Investor CSDs	Low: The control is solely based on the implementation of restriction rules and could be required as Issuer CSD, therefore the impact is low	None: No impact since this restriction is used by the CSD to bypass other restriction rules			
27	Operational Procedures	Clearstream (CBF)	Storno - CVAL	Settlement Instruction	CSD Validation Hold (CVAL)	Settlement instructions sent to T2S with the specific "Storno" BIC as Instructing Party (used by Clearstream) will be used to bypass (negative rule) other restriction rules (CSD Validation Hold)	Necessary: The process is considered necessary as operational procedures shall be defined by an Issuer CSD to ensure the management of operational risk on the settlement platform for all its	Low: The control is solely based on the implementation of restriction rules and could be required as Issuer CSD, therefore the impact is low	None: No impact since this restriction is used by the CSD to bypass other restriction rules			

Id	Business Process	CSD	Control/Restriction rule description ¹⁴¹				Impact Assessment				Additional comments
			Name	Object restriction type	Restriction processing type	Description of the control	Criterion 1 Character of the service / process	Criterion 2 Effort of implementing controls in Investor CSD's structure	Criterion 3 Risk of <u>not</u> implementing controls in Investor CSD's structure	Status	
							participants, including Investor CSDs				
28	Operational Procedures	Clearstream (CBF)	ICP only business processes - Reject	Settlement Instruction	Rejection	Settlement instructions sent to T2S with specific ISO transaction codes (used by Clearstream only) will be used to bypass (negative rule) other restriction rules (rejection)	Necessary: The process is considered necessary as operational procedures shall be defined by an Issuer CSD to ensure the management of operational risk on the settlement platform for all its participants, including Investor CSDs	Low: The control is solely based on the implementation of restriction rules and could be required as Issuer CSD, therefore the impact is low	None: No impact since this restriction is used by the CSD to bypass other restriction rules		
29	Operational Procedures	Clearstream (CBF)	ICP only business processes - Reject	Settlement Instruction	Rejection	FOP settlement instructions sent to T2S as already matched with specific ISO transaction codes and specific account type (identified with MSA) will be used to bypass (negative rule) other restriction rules (rejection)	Necessary: The process is considered necessary as operational procedures shall be defined by an Issuer CSD to ensure the management of operational risk on the settlement platform for all its participants, including Investor CSDs	High: The control is based on the implementation of MSAs therefore the impact is high	None: No impact since this restriction is used by specific actors to bypass other restriction rules		
30	Operational Procedures	Clearstream (CBF)	ICP only business processes - Reject	Settlement Instruction	Rejection	FOP settlement instructions sent to T2S as already matched with specific ISO transaction codes and	Necessary: The process is considered	High: The control is based on the implementation of	None: No impact since this restriction is used by		

Id	Business Process	CSD	Control/Restriction rule description ¹⁴¹				Impact Assessment				Additional comments
			Name	Object restriction type	Restriction processing type	Description of the control	Criterion 1 Character of the service / process	Criterion 2 Effort of implementing controls in Investor CSD's structure	Criterion 3 Risk of <u>not</u> implementing controls in Investor CSD's structure	Status	
						specific party type (identified with MSA) will be used to bypass (negative rule) other restriction rules (rejection)	necessary as operational procedures shall be defined by an Issuer CSD to ensure the management of operational risk on the settlement platform for all its participants, including Investor CSDs	MSAs therefore the impact is high	specific actors to bypass other restriction rules		
31	Operational Procedures	Clearstream (CBF)	ICP only business processes - CVAL	Settlement Instruction	CSD Validation Hold (CVAL)	Settlement instructions sent to T2S with specific ISO transaction codes (used by Clearstream only) will be used to bypass (negative rule) other restriction rules (CSD Validation Hold)	Necessary: The process is considered necessary as operational procedures shall be defined by an Issuer CSD to ensure the management of operational risk on the settlement platform for all its participants, including Investor CSDs	Low: The control is solely based on the implementation of restriction rules and could be required as Issuer CSD, therefore the impact is low	None: No impact since this restriction is used by the CSD to bypass other restriction rules		
32	Operational Procedures	Clearstream (CBF)	ICP only business processes - CVAL	Settlement Instruction	CSD Validation Hold (CVAL)	FOP settlement instructions sent to T2S as already matched with specific ISO transaction codes and specific account type (identified with MSA) will be used to bypass (negative rule) other restriction rules (CSD Validation Hold)	Necessary: The process is considered necessary as operational procedures shall be defined by an Issuer CSD to ensure the management of operational risk	High: The control is based on the implementation of MSAs therefore the impact is high	None: No impact since this restriction is used by specific actors to bypass other restriction rules		

Id	Business Process	CSD	Control/Restriction rule description ¹⁴¹				Impact Assessment				Additional comments	
			Name	Object restriction type	Restriction processing type	Description of the control	Criterion 1 Character of the service / process	Criterion 2 Effort of implementing controls in Investor CSD's structure	Criterion 3 Risk of not implementing controls in Investor CSD's structure	Status		
							on the settlement platform for all its participants, including Investor CSDs					
33	Operational Procedures	Clearstream (CBF)	ICP only business processes - CVAL	Settlement Instruction	CSD Validation Hold (CVAL)	FOP settlement instructions sent to T2S as already matched with specific ISO transaction codes and specific party type (identified with MSA) will be used to bypass (negative rule) other restriction rules (CSD Validation Hold)	Necessary: The process is considered necessary as operational procedures shall be defined by an Issuer CSD to ensure the management of operational risk on the settlement platform for all its participants, including Investor CSDs	High: The control is based on the implementation of MSAs therefore the impact is high	None: No impact since this restriction is used by specific actors to bypass other restriction rules			
34	Other Regulatory Compliance	Clearstream (CBF)	Security Blocking	Security	Blocking	Some securities (identified with MSA) must be temporarily restricted from settlement (Kassenverein Sperren)	Necessary: The service is necessary according to the definition	High: The control is based on the implementation of MSAs therefore the impact is high	Low: Impact is low as cross-CSD transactions could be pending but there is no risk of cancellation (according to CBF)			
35	Registration	Clearstream (CBF)	Registered Shares - Reject + RSHB	Settlement Instruction on securities position	Rejection	Usage of specific securities positions holding registered securities (identified with MSA) is restricted, settlement instructions on these positions are rejected, except in certain cases	Necessary: The service is necessary according to the definition	High: The control is based on the implementation of MSAs therefore the impact is high	High: The impact is high as not implementing the control could result in non-compliance with German law concerning registration duty as well as possibly rights over the security not being exercised due to a discrepancy between			

Id	Business Process	CSD	Control/Restriction rule description ¹⁴¹				Impact Assessment				Additional comments
			Name	Object restriction type	Restriction processing type	Description of the control	Criterion 1 Character of the service / process	Criterion 2 Effort of implementing controls in Investor CSD's structure	Criterion 3 Risk of not implementing controls in Investor CSD's structure	Status	
									actual and registered owner		
36	Registration	Clearstream (CBF)	Registered Shares - CVAL + RHSB	Settlement Instruction on securities position	CSD Validation Hold (CVAL)	Settlement instructions sent as already matched to T2S and debiting securities positions holding registered securities are put on CVAL	Necessary: The service is necessary according to the definition	High: The control requires segregation of securities positions as well as implementation of restriction rules and is not needed for the activity as Issuer CSD	High: The impact is high as not implementing the control could result in non-compliance with German law concerning registration duty as well as possibly rights over the security not being exercised due to a discrepancy between actual and registered owner		
37	Registration	Clearstream (CBF)	Registered Shares - Reject + RSKE	Settlement Instruction on securities position	Rejection	Usage of specific securities positions created in the context of the issuance processes for registered shares (identified with MSA) is restricted, settlement instructions sent by CSD participants on these positions are rejected	Necessary: The service is necessary according to the definition	High: The control is based on the implementation of MSAs therefore the impact is high	High: The impact is high as not implementing the control could result in settlement of securities which are restricted at the Issuer CSD		
38	Registration	Clearstream (CBF)	Registered Shares - CVAL + RSKE	Settlement Instruction on securities position	CSD Validation Hold (CVAL)	Usage of specific securities positions created in the context of the issuance processes for registered shares is restricted, settlement instructions on these securities positions are put on CVAL	Necessary: The service is necessary according to the definition	High: The control requires segregation of securities positions as well as implementation of restriction rules and is not needed for the activity as Issuer CSD	High: The impact is high as not implementing the control could result in settlement of securities which are restricted at the Issuer CSD		
39	Static Data Configuration	Clearstream (CBF)	Party and account configuration - Reject	Settlement Instruction on securities position	Rejection	Some securities accounts (identified with MSA) are not allowed for DVP settlement, while some other securities accounts cannot hold specific	Optional: The process is considered optional as it is defined by a CSD for internal static	High: The control is based on the implementation of MSAs therefore the impact is high	None: Technically, this control will not impact Investor CSDs' settlement flows (will apply at the level of Business Instruction in		

Id	Business Process	CSD	Control/Restriction rule description ¹⁴¹				Impact Assessment				Additional comments
			Name	Object restriction type	Restriction processing type	Description of the control	Criterion 1 Character of the service / process	Criterion 2 Effort of implementing controls in Investor CSD's structure	Criterion 3 Risk of <u>not</u> implementing controls in Investor CSD's structure	Status	
						securities positions	data management purposes		CBF)		
40	Static Data Configuration	Clearstream (CBF)	Security Blocking	Security	Blocking	Prior to the deletion of a security in T2S static data, settlement instructions on this security are blocked, except if sent with the "Storno" BIC as Instructing Party	Optional: The process is considered optional as it is defined by a CSD for internal static data management purposes	Low: Impact is low as it is solely based on the implementation of a restriction rule without the need to segregate or implement an MSA. This control is likely to be needed as Issuer CSD	Medium: Impact is medium as cross-CSD transactions could be pending and require bilateral cancellation of the settlement instructions		
41	Static Data Configuration	Clearstream (CBF)	Account Blocking	Securities Account	Blocking	Prior to the deletion of a securities account in T2S static data, settlement instructions on this securities account are blocked, except if sent with the "Storno" BIC as Instructing Party	Optional: The process is considered optional as it is defined by a CSD for internal static data management purposes	Low: Impact is low as it is solely based on the implementation of a restriction rule without the need to segregate or implement an MSA. This control is likely to be needed as Issuer CSD	Medium: Impact is medium as cross-CSD transactions could be pending and require bilateral cancellation of the settlement instructions		
42	Static Data Configuration	Clearstream (CBF)	Party Blocking	Party	Blocking	Prior to the deletion of a party in T2S static data, settlement instructions are blocked	Optional: The process is considered optional as it is defined by a CSD for internal static data management purposes	Low: Impact is low as it is solely based on the implementation of a restriction rule without the need to segregate or implement an MSA. This control is likely to be needed as Issuer CSD	Medium: Impact is medium as cross-CSD transactions could be pending and require bilateral cancellation of the settlement instructions		
43	Corporate Actions	Depozitarul Central	RT04DC	Settlement Instruction	Rejection	Settlement instructions sent by CSD participants using ISO transaction codes "CORP" and "CLAI" are rejected, as the usage is reserved for the processing of Corporate Actions	Necessary: The service is necessary according to the definition	None: As this control can be implemented by privileges instead of restriction rules, there is no impact	None: As this control can be implemented by privileges instead of restriction rules, there is no impact.		Investor CSDs' instructions will never be impacted by the rule
44	Corporate	Depozitarul	RT05DC	Security	Blocking	During the processing of	Necessary:	Low:	High:		

Id	Business Process	CSD	Control/Restriction rule description ¹⁴¹				Impact Assessment				Additional comments
			Name	Object restriction type	Restriction processing type	Description of the control	Criterion 1 Character of the service / process	Criterion 2 Effort of implementing controls in Investor CSD's structure	Criterion 3 Risk of not implementing controls in Investor CSD's structure	Status	
	Actions	Central				certain Corporate Actions, block all settlement instructions in the concerned ISIN, except if sent using "CORP" ISO transaction code	The service is necessary according to the definition	The control is solely based on the implementation of restriction rules and is generally needed for the activity as Issuer CSD	The impact is high as not implementing the control could result in settlement of securities that are restricted from settlement at the Issuer CSD		
45	Insolvency Procedures	Depozitarul Central	RT01DC	Settlement Instruction	Rejection	Settlement instructions sent by suspended CSD participants (identified with MSA) are rejected	Necessary: The service is necessary according to the definition	High: The control is based on the implementation of MSAs therefore the impact is high	High: Impact is high because potentially not complying with regulatory requirements (in the case where the participant is also participant of the Investor CSD)		
46	Other Regulatory Compliance	Depozitarul Central	RT02DC	Settlement Instruction	Rejection	Settlement instructions sent on suspended securities(identified with MSA) are rejected	Necessary: The service is necessary according to the definition	High: The control is based on the implementation of MSAs therefore the impact is high	High: Impact is high because potentially not complying with regulatory requirements depending on the scope of application, i.e. if it is applicable in the jurisdiction of the Investor CSD		
47	Other Regulatory Compliance	Depozitarul Central	RT03DC	Settlement Instruction	Rejection	Settlement instructions sent on suspended securities accounts (identified with MSA) are rejected	Necessary: The service is necessary according to the definition	High: The control is based on the implementation of MSAs therefore the impact is high	High: Impact is high because potentially not complying with regulatory requirements depending on the scope of the suspension, i.e. if it is applicable in the jurisdiction of the Investor CSD		
48	Collateral	ESES	RT08	Securities	Blocking	At client's request,	Optional:	Medium:	Low:		

Id	Business Process	CSD	Control/Restriction rule description ¹⁴¹				Impact Assessment				Additional comments
			Name	Object restriction type	Restriction processing type	Description of the control	Criterion 1 Character of the service / process	Criterion 2 Effort of implementing controls in Investor CSD's structure	Criterion 3 Risk of not implementing controls in Investor CSD's structure	Status	
	Management		(ESE-043-COL)	Account		earmarked securities positions are transferred to the deliverable position for end of day reporting. Prior to FOP cut-off, ESES does not allow any movements from and to the earmarked position ("EXXX") on the account of these clients	Collateral management services are categorised as optional	The control relies solely on the implementation of restriction rules and is not needed for the activity as Issuer CSD	Impact is low as cross-CSD transactions could be pending (if EXXX is used in a cross-CSD transaction) temporarily		
49	Corporate Actions	ESES	RT05 (ESE-019-COR)	Settlement Instruction	Rejection	Only allow securities subject to redemption by drawing, i.e. "Dematerialised drawing security" (identified with MSA) to be held on specific account types (i.e. Account Natures, identified with MSA)	Necessary: The service is necessary according to the definition	High: The control is based on the implementation of MSAs therefore the impact is high	None: No impact because the Account Natures subject to rejection are not held by Investor CSDs		
50	Corporate Actions	ESES	RT05 (ESE-021-COR)	Settlement Instruction	Rejection	Only allow securities flagged as "Redeemed drawing security" (identified with MSA) to be held on a specific account type (i.e. Account Natures, identified with MSA)	Necessary: The service is necessary according to the definition	High: The control is based on the implementation of MSAs therefore the impact is high	None: No impact because the Account Nature subject to rejection are not held by Investor CSDs		
51	Corporate Actions	ESES	RT05 (ESE-022-COR)	Settlement Instruction	Rejection	Only allow "entitlement/rights" securities (identified with MSA) created in the context of Distribution with Options to be held on specific account types (i.e. Account Natures, identified with MSA)	Necessary: The service is necessary according to the definition	High: The control is based on the implementation of MSAs therefore the impact is high	High: The Account Nature 001 is necessary for Investor CSDs to hold registered securities and subject to rejection. Impact is high because settlement instruction of Investor CSDs could be cancelled after matching		Account Natures 000 (ordinary securities) and 001 (registered securities) are considered as the standard account types opened by Investor CSDs, with 001 only available in Euroclear France. The "red" status is only valid for Investor CSDs of Euroclear France as the rejection is

Id	Business Process	CSD	Control/Restriction rule description ¹⁴¹				Impact Assessment				Additional comments
			Name	Object restriction type	Restriction processing type	Description of the control	Criterion 1 Character of the service / process	Criterion 2 Effort of implementing controls in Investor CSD's structure	Criterion 3 Risk of not implementing controls in Investor CSD's structure	Status	
											triggered on Account Nature 001. Investor CSDs of Euroclear Belgium and Euroclear Netherlands are not impacted.
52	Corporate Actions	ESES	RT07 (ESE-032-COR)	Settlement Instruction	Rejection	Securities with legal form "bearer or registered" (identified with MSA) cannot be held on specific account types (i.e. Account Natures, identified with MSA)	Necessary: The service is necessary according to the definition	High: The control is based on the implementation of MSAs therefore the impact is high	None: No impact because the Account Natures subject to rejection are not held by Investor CSDs		
53	Corporate Actions	ESES	RT07 (ESE-038-COR)	Settlement Instruction	Rejection	Securities with legal form "bearer" (identified with MSA) on specific account types (i.e. Account Natures, identified with MSA)	Necessary: The service is necessary according to the definition	High: The control is based on the implementation of MSAs therefore the impact is high	None: No impact because the Account Natures subject to rejection are not held by Investor CSDs		
54	Corporate Actions	ESES	RT12 (ESE-058-COR)	Settlement Instruction	Rejection	Some French securities provide a loyalty bonus: these must however not be transferred during a certain lock-up period. During this period, settlement instructions against payment on these securities are rejected.	Necessary: The service is necessary according to the definition	Medium: The control is solely based on the implementation of restriction rules and is not needed for the activity as Issuer CSD	High: The impact is high as not implementing the control could result in settlement instruction of Investor CSDs being cancelled after matching, or the loss of rights attached to the securities		Based on quantitative aspects, impact on Investor CSDs should be limited. Indeed, this process only concerns a dozen of French ISIN codes. The "red" status is only relevant for Investor CSDs of Euroclear France.
55	Foreign Securities	ESES	RT05 (ESE-014-FOR)	Settlement Instruction	Rejection	Securities flagged as "Foreign security" (identified with MSA) cannot be held on specific account types (i.e. Account Nature, identified with MSA)	Optional: The service is considered necessary or optional depending on whether the CSD	High: The control is based on the implementation of MSAs therefore the impact is high	None: No impact because the Account Natures subject to rejection are not held by Investor CSDs		

Id	Business Process	CSD	Control/Restriction rule description ¹⁴¹				Impact Assessment				Additional comments	
			Name	Object restriction type	Restriction processing type	Description of the control	Criterion 1 Character of the service / process	Criterion 2 Effort of implementing controls in Investor CSD's structure	Criterion 3 Risk of not implementing controls in Investor CSD's structure	Status		
							defining the rules is acting as Issuer CSD or instead as Technical Issuer CSD or Investor CSD					
56	Foreign Securities	ESES	RT05 (ESE-016-FOR)	Settlement Instruction	Rejection	Securities flagged as "Domestic dematerialised security except drawing" (identified with MSA) cannot be held on a specific account type reserved for cross-CSD activity (i.e. Account Nature 080, identified with MSA)	Optional: The service is considered necessary or optional depending on whether the CSD defining the rules is acting as Issuer CSD or instead as Technical Issuer CSD or Investor CSD	High: The control is based on the implementation of MSAs therefore the impact is high	None: No impact because the Account Natures subject to rejection are not held by Investor CSDs			
57	Foreign Securities	ESES	RT06 (ESE-027-FOR)	Settlement Instruction	Rejection	Securities flagged as "Securities Held in Foreign CSD" (identified with MSA) cannot be held on specific account types (i.e. Account Nature, identified with MSA)	Optional: The service is considered necessary or optional depending on whether the CSD defining the rules is acting as Issuer CSD or instead as Technical Issuer CSD or Investor CSD	High: The control is based on the implementation of MSAs therefore the impact is high	None: No impact because the Account Natures subject to rejection are not held by Investor CSDs			
58	Foreign Securities	ESES	RT07 (ESE-042-FOR)	Settlement Instruction	Rejection	Securities with legal form 'foreign securities (held in EF)' (identified with MSA) cannot be held on specific account types (identified with MSA)	Optional: The service is considered necessary or optional depending on	High: The control is based on the implementation of MSAs therefore the impact is high	High: The Account Nature 001 holding registered securities is available to Investor CSDs and subject to rejection.			Account Natures 000 (ordinary securities) and 001 (registered securities) are considered as the standard account

Id	Business Process	CSD	Control/Restriction rule description ¹⁴¹				Impact Assessment				Additional comments
			Name	Object restriction type	Restriction processing type	Description of the control	Criterion 1 Character of the service / process	Criterion 2 Effort of implementing controls in Investor CSD's structure	Criterion 3 Risk of not implementing controls in Investor CSD's structure	Status	
							whether the CSD defining the rules is acting as Issuer CSD or instead as Technical Issuer CSD or Investor CSD		Impact is high because settlement instruction of Investor CSDs could be cancelled after matching		types opened by Investor CSDs, with 001 only available in Euroclear France. The "yellow" status is only relevant for Investor CSDs of Euroclear France as the rejection is triggered on Account Nature 001. Investor CSDs of Euroclear Belgium and Euroclear Netherlands are not impacted.
59	Insolvency Procedures	ESES	RT01 (ESE-001-REC)	Securities Account	Blocking	Delivering settlement instructions are blocked on suspended securities accounts upon request of the competent authorities	Necessary: The service is necessary according to the definition	Low: The control is solely based on the implementation of restriction rules and is generally needed for the activity as Issuer CSD	High: Impact is high because potentially not complying with regulatory requirements depending on the scope of the suspension (in the case where the participant is also participant of the Investor CSD)		The "yellow" status is valid for all 3 CSDs Euroclear France, Euroclear Belgium, and Euroclear Netherlands, based on the assumption that these restriction rules will be used in all CSDs the event of insolvency.
60	Insolvency Procedures	ESES	RT09 (ESE-044-REC)	Party	Blocking	Settlement instructions are blocked on suspended parties upon request of the competent authorities, except for specific transaction types such as Corporate Actions, auto-collateralisation reimbursement instructions, realignment instructions, or specific instructions sent by Euroclear CSDs	Necessary: The service is necessary according to the definition	Low: The control is solely based on the implementation of restriction rules and is generally needed for the activity as Issuer CSD	High: Impact is high because potentially not complying with regulatory requirements depending on the scope of the suspension (in the case where the participant is also participant of the Investor CSD)		The "yellow" status is valid for all 3 CSDs Euroclear France, Euroclear Belgium, and Euroclear Netherlands, based on the assumption that these restriction rules will be used in all CSDs the event of insolvency.

Id	Business Process	CSD	Control/Restriction rule description ¹⁴¹				Impact Assessment				Additional comments
			Name	Object restriction type	Restriction processing type	Description of the control	Criterion 1 Character of the service / process	Criterion 2 Effort of implementing controls in Investor CSD's structure	Criterion 3 Risk of <u>not</u> implementing controls in Investor CSD's structure	Status	
											Note the rule will not prevent all settlement flows in case the blocked party is the Investor CSD
61	Investment Funds Processing	ESES	RT03 (ESE-008-IFP)	Settlement Instruction	Rejection	Subscription operations (identified with ISO transaction code "SUBS") of fund shares can only be performed by the debit of a specific account(i.e. Account Natures, identified with MSA)	Optional: Services related to Investment Funds Processing are considered optional	High: The control is based on the implementation of MSAs therefore the impact is high	None: Impact of not implementing is none because realignment instructions will not be impacted by the rule due to usage of ISO transaction code and Account Natures subject to rejection are not held by Investor CSDs		
62	Investment Funds Processing	ESES	RT03 (ESE-009-IFP)	Settlement Instruction	Rejection	Subscription operations (identified with ISO transaction code "SUBS") of fund shares can only be performed by the credit of specific accounts(i.e. Account Natures, identified with MSA)	Optional: Services related to Investment Funds Processing are considered optional	High: The control is based on the implementation of MSAs therefore the impact is high	None: Impact of not implementing is none because realignment instructions will not be impacted by the rule due to usage of ISO transaction code and Account Natures subject to rejection are not held by Investor CSDs		
63	Investment Funds Processing	ESES	RT03 (ESE-010-IFP)	Settlement Instruction	Rejection	Redemption operations (identified with ISO transaction code "REDM") of fund shares can only be performed by the debit of a specific account(i.e. Account Natures, identified with MSA)	Optional: Services related to Investment Funds Processing are considered optional	High: The control is based on the implementation of MSAs therefore the impact is high	None: Impact of not implementing is none because realignment instructions will not be impacted by the rule due to usage of ISO transaction code and Account Natures subject to rejection are not held		

Id	Business Process	CSD	Control/Restriction rule description ¹⁴¹				Impact Assessment				Additional comments	
			Name	Object restriction type	Restriction processing type	Description of the control	Criterion 1 Character of the service / process	Criterion 2 Effort of implementing controls in Investor CSD's structure	Criterion 3 Risk of not implementing controls in Investor CSD's structure	Status		
64	Investment Funds Processing	ESES	RT03 (ESE-011-IFP)	Settlement Instruction	Rejection	Redemption operations (identified with ISO transaction code "REDM") of fund shares can only be performed by the credit of specific accounts(i.e. Account Natures, identified with MSA)	Optional: Services related to Investment Funds Processing are considered optional	High: The control is based on the implementation of MSAs therefore the impact is high	None: Impact of not implementing is none because realignment instructions will not be impacted by the rule due to usage of ISO transaction code and Account Natures subject to rejection are not held by Investor CSDs			
65	Issuance	ESES	RT03 (ESE-004-ISS)	Settlement Instruction	Rejection	Placement operations (identified with ISO transaction code "PLAC") can only be performed by the debit and credit of specific accounts (i.e. Account Natures, identified with MSA) or with specific instruments (i.e. Security group "TCN", identified with MSA)	Optional: Issuance services are considered optional	High: The control is based on the implementation of MSAs therefore the impact is high	None: Impact of not implementing is none because realignment instructions will not be impacted by the rule due to usage of ISO transaction code			
66	Issuance	ESES	RT03 (ESE-005-ISS)	Settlement Instruction	Rejection	Placement operations (identified with ISO transaction code PLAC) can only be performed by the debit and credit of specific accounts (i.e. Account Natures, identified with MSA) or with specific instruments (i.e. Security group "TCN", identified with MSA)	Optional: Issuance services are considered optional	High: The control is based on the implementation of MSAs therefore the impact is high	None: Impact of not implementing is none because realignment instructions will not be impacted by the rule due to usage of ISO transaction code			
67	Issuance	ESES	RT03 (ESE-012-ISS)	Settlement Instruction	Rejection	Placement operations (identified with ISO transaction code PLAC) can only be performed by the debit and credit of	Optional: Issuance services are considered optional	High: The control is based on the implementation of MSAs therefore the	None: Impact of not implementing is none because realignment			

Id	Business Process	CSD	Control/Restriction rule description ¹⁴¹				Impact Assessment				Additional comments
			Name	Object restriction type	Restriction processing type	Description of the control	Criterion 1 Character of the service / process	Criterion 2 Effort of implementing controls in Investor CSD's structure	Criterion 3 Risk of <u>not</u> implementing controls in Investor CSD's structure	Status	
						specific accounts (i.e. Account Natures, identified with MSA) or with specific instruments (i.e. Security Group "TCN", identified with MSA)		impact is high	instructions will not be impacted by the rule due to usage of ISO transaction code		
68	Issuance	ESES	RT03 (ESE-006-ISS)	Settlement Instruction	Rejection	Issuance operations (identified with ISO transaction code "ISSU") of Warrants (identified with MSA) can only be performed by the debit and credit of specific accounts(i.e. Account Natures, identified with MSA)	Optional: Issuance services are considered optional	High: The control is based on the implementation of MSAs therefore the impact is high	None: Impact of not implementing is none because realignment instructions will not be impacted by the rule due to usage of ISO transaction code		
69	Issuance	ESES	RT03 (ESE-007-ISS)	Settlement Instruction	Rejection	Issuance operations (identified with ISO transaction code "ISSU") of Warrants (identified with MSA) can only be performed by the debit and credit of specific accounts(i.e. Account Natures, identified with MSA)	Optional: Issuance services are considered optional	High: The control is based on the implementation of MSAs therefore the impact is high	None: Impact of not implementing is none because realignment instructions will not be impacted by the rule due to usage of ISO transaction code		
70	Issuance	ESES	RT03 (ESE-052-ISS)	Settlement Instruction	Rejection	Issuance operations (identified with ISO transaction code "ISSU") of TCN securities (identified with MSA) can only be performed by the debit and credit of specific accounts(i.e. Account Natures, identified with MSA)	Optional: Issuance services are considered optional	High: The control is based on the implementation of MSAs therefore the impact is high	None: Impact of not implementing is none because realignment instructions will not be impacted by the rule due to usage of ISO transaction code		
71	Issuance	ESES	RT03 (ESE-053-ISS)	Settlement Instruction	Rejection	Issuance operations (identified with ISO transaction code "ISSU") of TCN securities (identified	Optional: Issuance services are considered	High: The control is based on the implementation of	None: Impact of not implementing is none		

Id	Business Process	CSD	Control/Restriction rule description ¹⁴¹				Impact Assessment				Additional comments
			Name	Object restriction type	Restriction processing type	Description of the control	Criterion 1 Character of the service / process	Criterion 2 Effort of implementing controls in Investor CSD's structure	Criterion 3 Risk of not implementing controls in Investor CSD's structure	Status	
						with MSA) can only be performed by the debit and credit of specific accounts(i.e. Account Natures, identified with MSA)	optional	MSAs therefore the impact is high	because realignment instructions will not be impacted by the rule due to usage of ISO transaction code		
72	Issuance	ESES	RT05 (ESE-017-ISS)	Settlement Instruction	Rejection	Securities flagged as "Domestic dematerialised security except drawing" (identified with MSA) cannot be held on a specific account type dedicated to Issuance (i.e. Account Nature 092, identified with MSA)	Optional: Issuance services are considered optional	High: The control is based on the implementation of MSAs therefore the impact is high	None: Impact of not implementing is none because the issuance accounts subject to the rule are not held by Investor CSDs		
73	Issuance	ESES	RT05 (ESE-024-ISS)	Settlement Instruction	Rejection	Securities flagged as "TCN and French Treasury Bills" (identified with MSA) can only be held on a few specific account types (i.e. Account Nature, identified with MSA)	Optional: Issuance services are considered optional	High: The control is based on the implementation of MSAs therefore the impact is high	High: The Account Nature 001 is necessary for Investor CSDs to hold registered securities and subject to rejection. Impact is high because settlement instruction of Investor CSDs could be cancelled after matching		Account Natures 000 (ordinary securities) and 001 (registered securities) are considered as the standard account types opened by Investor CSDs, with 001 only available in Euroclear France. The "yellow" status is only valid for Investor CSDs of Euroclear France as the rejection is triggered on Account Nature 001. Investor CSDs of Euroclear Belgium and Euroclear Netherlands are not impacted.
74	Issuance	ESES	RT07 (ESE-	Settlement Instruction	Rejection	Securities with legal form "Bearer or registered"	Optional: Issuance services	High: The control is based on	None: Impact of not		

Id	Business Process	CSD	Control/Restriction rule description ¹⁴¹				Impact Assessment				Additional comments
			Name	Object restriction type	Restriction processing type	Description of the control	Criterion 1 Character of the service / process	Criterion 2 Effort of implementing controls in Investor CSD's structure	Criterion 3 Risk of not implementing controls in Investor CSD's structure	Status	
			033-ISS)			(identified with MSA) cannot be held on specific account types related to issuance (i.e. Account Natures 092 and 105, identified with MSA)	are considered optional	the implementation of MSAs therefore the impact is high	implementing is none because the issuance accounts subject to the rule are not held by Investor CSDs		
75	Issuance	ESES	RT07 (ESE-039-ISS)	Settlement Instruction	Rejection	Securities with legal form "Bearer" (identified with MSA) cannot be held on a specific account type related to issuance (i.e. Account Nature 105, identified with MSA)	Optional: Issuance services are considered optional	High: The control is based on the implementation of MSAs therefore the impact is high	None: Impact of not implementing is none because the issuance accounts subject to the rule are not held by Investor CSDs		
76	Issuance	ESES	RT18 (ESE-049-ISS)	Settlement Instruction	CSD Validation Hold (CVAL)	For specific account types related to issuance (i.e. Account Nature, identified with MSA), settlement instructions sent by CSD participants are put on CVAL for ESES to perform additional validations	Optional: Issuance services are considered optional	High: The control is based on the implementation of MSAs therefore the impact is high	None: Impact of not implementing is none because the issuance accounts subject to the rule are not held by Investor CSDs		
77	Non-European Regulations	ESES	RT05 (ESE-18-NER)	Settlement Instruction	Rejection	TEFRA-D securities (identified with MSA) are segregated into a specific account type (i.e. Account nature 086, identified with MSA) during the lock-up period and cannot be transferred until certification of underlying investors has been received	Optional: Services related to Non-European Regulations put in place to support intermediaries are considered optional	High: The control is based on the implementation of MSAs therefore the impact is high	High: The impact is high as settlement instructions may be cancelled after matching (Account Nature subject to rejection may be held by Investor CSDs)		The "yellow" status is relevant for Investor CSDs of all ESES CSDs, as NDC086 can be opened for Investor CSDs of Euroclear France, Belgium and Netherlands.
78	Non-standardised securities	ESES	RT05 (ESE-020-NSS)	Settlement Instruction	Rejection	Securities flagged as "physical securities" (identified with MSA) cannot be held on specific account types (i.e. Account natures)	Optional: Services related to Non-Standardised Securities are considered optional	High: The control is based on the implementation of MSAs therefore the impact is high	None: Impact of not implementing is none because the accounts subject to rejection are not held by Investor CSDs		

Id	Business Process	CSD	Control/Restriction rule description ¹⁴¹				Impact Assessment				Additional comments
			Name	Object restriction type	Restriction processing type	Description of the control	Criterion 1 Character of the service / process	Criterion 2 Effort of implementing controls in Investor CSD's structure	Criterion 3 Risk of <u>not</u> implementing controls in Investor CSD's structure	Status	
79	Operational Procedures	ESES	RT16 (ESE-058-OPE)	Security	Blocking	In some specific cases, securities impacted by a change of fractional digits which are not handled through Corporate Actions need to be blocked following an operational procedure.	Necessary: The process is considered necessary as operational procedures shall be defined by an Issuer CSD to ensure the management of operational risk on the settlement platform for all its participants, including Investor CSDs	Low: The control is solely based on the implementation of restriction rules and is needed for the activity as Issuer CSD	High: The impact is high as not implementing the control could result in settlement of securities that are restricted from settlement at the Issuer CSD		This control may be necessary to manage residual cases not covered by CR538
80	Operational Procedures	ESES	RT19 (ESE-050-OPE)	Settlement Instruction	Rejection	Settlement instructions sent to T2S with TURN ISO transaction code (used by ESES only) will be used to bypass (negative rule) other restriction rules (rejection)	Necessary: The process is considered necessary as operational procedures shall be defined by an Issuer CSD to ensure the management of operational risk on the settlement platform for all its participants, including Investor CSDs	Low: The control is solely based on the implementation of restriction rules and could be required as Issuer CSD, therefore the impact is low	None: No impact since this restriction is used by the CSD to bypass other restriction rules		
81	Operational Procedures	ESES	RT20 (ESE-051-OPE)	Settlement Instruction	CSD Validation Hold (CVAL)	Settlement instructions sent to T2S with TURN ISO transaction code (used by ESES only) will be used to bypass (negative rule) other restriction rules (CSD Validation Hold)	Necessary: The process is considered necessary as operational procedures shall be defined by an	Low: The control is solely based on the implementation of restriction rules and could be required as Issuer CSD, therefore	None: No impact since this restriction is used by the CSD to bypass other restriction rules		

Id	Business Process	CSD	Control/Restriction rule description ¹⁴¹				Impact Assessment				Additional comments
			Name	Object restriction type	Restriction processing type	Description of the control	Criterion 1 Character of the service / process	Criterion 2 Effort of implementing controls in Investor CSD's structure	Criterion 3 Risk of not implementing controls in Investor CSD's structure	Status	
							Issuer CSD to ensure the management of operational risk on the settlement platform for all its participants, including Investor CSDs	the impact is low			
82	Registration	ESES	RT15 (ESE-046-REG)	Settlement Instruction	CSD Validation Hold (CVAL)	Settlement instructions on Belgian registered securities can only be instructed by the CSD Euroclear Belgium in T2S, otherwise they are put on CSD Validation hold	Necessary: The service is necessary according to the definition	Not available: The Stock Exchange flows (trade feed received by Euronext) prevent any active role of Investor CSDs in the settlement process for Belgian registered securities (i.e. in DCP mode). The eligibility to hold the securities is decided by the registrar.			The impact from this restriction originating from the issuer is strongly mitigated due to the fact that the limitation just concerns 3 non-standardised ISINs with little trading activity (around 4500 trades per year, 0.18% of yearly transactions).
83	Registration	ESES	RT02 (ESE-002-REG)	Settlement Instruction	Rejection	Settlement instructions on a specific account type "Registered securities which come from corporate actions currently being registered with the issuer" (identified with MSA) sent by CSD participants are rejected	Necessary: The service is necessary according to the definition	High: The control is based on the implementation of MSAs therefore the impact is high	None: No impact because the Account Natures subject to rejection are not held by Investor CSDs		
84	Registration	ESES	RT05 (ESE-015-REG)	Settlement Instruction	Rejection	Securities flagged as "Domestic dematerialised security except drawing" (identified with MSA Security Category) cannot be held on a specific account type (i.e. Account Nature, identified with	Necessary: The service is necessary according to the definition	High: The control is based on the implementation of MSAs therefore the impact is high	None: No impact because the Account Natures subject to rejection are not held by Investor CSDs		

Id	Business Process	CSD	Control/Restriction rule description ¹⁴¹				Impact Assessment				Additional comments
			Name	Object restriction type	Restriction processing type	Description of the control	Criterion 1 Character of the service / process	Criterion 2 Effort of implementing controls in Investor CSD's structure	Criterion 3 Risk of <u>not</u> implementing controls in Investor CSD's structure	Status	
						MSA)					
85	Registration	ESES	RT07 (ESE-035-REG)	Settlement Instruction	Rejection	Securities with legal form "Registered" (identified with MSA) cannot be held on specific account types (i.e. Account Nature, identified with MSA)	Necessary: The service is necessary according to the definition	High: The control is based on the implementation of MSAs therefore the impact is high	High: Impact of not implementing is high because settlement instruction of the Investor CSD's participant could be cancelled after matching		Account Natures 000 (ordinary securities) and 001 (registered securities) are considered as the standard account types opened by Investor CSDs, with 001 only available in Euroclear France. The "red" status is valid for Investor CSDs of Euroclear France only, based on the assumption that: - Account Nature 000 is available in all 3CSDs - securities with legal form "registered" are only available in Euroclear France
86	Registration	ESES	RT07 (ESE-036-REG)	Settlement Instruction	Rejection	Securities with legal form "Bearer" (identified with MSA) cannot be held on specific account types (i.e. Account Nature, identified with MSA)	Necessary: The service is necessary according to the definition	High: The control is based on the implementation of MSAs therefore the impact is high	High: Impact of not implementing is high because settlement instruction of the Investor CSD's participant could be cancelled after matching		Account Natures 000 (ordinary securities) and 001 (registered securities) are considered as the standard account types opened by Investor CSDs, with 001 only available in Euroclear France. The "red" status is valid for Investor CSDs of Euroclear France only, based on the assumption

Id	Business Process	CSD	Control/Restriction rule description ¹⁴¹				Impact Assessment				Additional comments
			Name	Object restriction type	Restriction processing type	Description of the control	Criterion 1 Character of the service / process	Criterion 2 Effort of implementing controls in Investor CSD's structure	Criterion 3 Risk of <u>not</u> implementing controls in Investor CSD's structure	Status	
											that: - Account Nature 000 is available in all 3CSDs - securities with legal form "bearer" are only available in Euroclear France
87	Registration	ESES	RT07 (ESE-040-REG)	Settlement Instruction	Rejection	Securities with legal form "Securities deposited in EBE or ENL (domestic or foreign)" (identified with MSA) cannot be held on specific account types (identified with MSA)	Necessary: The service is necessary according to the definition	High: The control is based on the implementation of MSAs therefore the impact is high	High: Impact of not implementing is high because settlement instruction of the Investor CSD's participant could be cancelled after matching		Account Natures 000 (ordinary securities) and 001 (registered securities) are considered as the standard account types opened by Investor CSDs, with 001 only available in Euroclear France. The "red" status is only valid for Investor CSDs of Euroclear France as the rejection is triggered on Account Nature 001. Investor CSDs of Euroclear Belgium and Euroclear Netherlands are not impacted.
88	Registration	ESES	RT18 (ESE-047-REG)	Settlement Instruction	CSD Validation Hold (CVAL)	Settlement instructions on securities with legal form "Bearer or registered" (identified with MSA) are put on CVAL if using the standard account type (identified with MSA) dedicated to registered securities (001), if the	Necessary: The service is necessary according to the definition	High: The control is based on the implementation of MSAs therefore the impact is high	High: Impact of not implementing is high because settlement instruction of the Investor CSD's participant could be cancelled after matching		Account Natures 000 (ordinary securities) and 001 (registered securities) are considered as the standard account types opened by Investor CSDs, with

Id	Business Process	CSD	Control/Restriction rule description ¹⁴¹				Impact Assessment				Additional comments
			Name	Object restriction type	Restriction processing type	Description of the control	Criterion 1 Character of the service / process	Criterion 2 Effort of implementing controls in Investor CSD's structure	Criterion 3 Risk of <u>not</u> implementing controls in Investor CSD's structure	Status	
						instructing party is an external CSD or a CSD participant, except if instructing with Transaction identification code 'OWNE'					001 only available in Euroclear France. The "red" status is only valid for Investor CSDs of Euroclear France as the rejection is triggered on Account Nature 001. Investor CSDs of Euroclear Belgium and Euroclear Netherlands are not impacted.
89	Registration	ESES	RT18 (ESE-048-REG)	Settlement Instruction	CSD Validation Hold (CVAL)	Settlement instructions on specific account types (identified with MSA) used in the context of Registration (008, 009) are put on CVAL if the instructing party is an external CSD or a CSD participant, except if instructing with Transaction identification code 'OWNE'.	Necessary: The service is necessary according to the definition	High: The control is based on the implementation of MSAs therefore the impact is high	None: No impact because the Account Natures subject to rejection are not held by Investor CSDs		
90	Static Data Configuration	ESES	RT04 (ESE-013-SDC)	Settlement Instruction on securities position	Rejection	Earmarking for auto-collateralisation is only allowed through the "EXXX" securities position, settlement instructions on "EEUR" securities position are rejected	Optional: The process is considered optional as it is defined by a CSD for internal static data management purposes	Medium: Impact is medium as it is solely based on the implementation of a restriction rule without the need to segregate or implement an MSA. This control is not generally needed as Issuer CSD	None: Technically, this control will not impact Investor CSDs' settlement flows (will apply at the level of Business Instruction in ESES)		
91	Static Data Configuration	ESES	RT06 (ESE-028-	Settlement Instruction	Rejection	Securities flagged as "Dematerialised securities or not admitted in ESES" cannot be held on a specific	Optional: The process is considered	High: The control is based on the implementation of	None: Impact of not implementing is none		

Id	Business Process	CSD	Control/Restriction rule description ¹⁴¹				Impact Assessment				Additional comments
			Name	Object restriction type	Restriction processing type	Description of the control	Criterion 1 Character of the service / process	Criterion 2 Effort of implementing controls in Investor CSD's structure	Criterion 3 Risk of not implementing controls in Investor CSD's structure	Status	
			SDC)			account type where the owner of the securities is unknown (i.e. Account Nature 094 , identified with MSA)	optional as it is defined by a CSD for internal static data management purposes	MSAs therefore the impact is high	because the accounts subject to rejection are not held by Investor CSDs		
92	Static Data Configuration	ESES	RT07 (ESE-030-SDC)	Settlement Instruction	Rejection	Several legal forms of securities (identified with MSA) cannot be held on a specific account type dedicated for trading brokers (i.e. Account Nature 010, identified with MSA)	Optional: The process is considered optional as it is defined by a CSD for internal static data management purposes	High: The control is based on the implementation of MSAs therefore the impact is high	None: Impact of not implementing is none because the accounts subject to rejection are not held by Investor CSDs		
93	Static Data Configuration	ESES	RT1A+ RT10 (ESE-045-SDC + ESE-SDC-057)	Settlement Restriction on securities position	Rejection	Settlement restrictions on all securities sub-positions are rejected, except those related to Conditional Securities Delivery (CoSD). Securities positions dedicated to auto-collateralisation can only be debited and credited through settlement instructions.	Optional: The process is considered optional as it is defined by a CSD for internal static data management purposes	Not available: Segregation of securities positions by blocking and reservation restriction types is not available to participants of ESES CSDs including Investor CSDs.			
94	Static Data Configuration	ESES	RT11 (ESE-054-SDC)	Settlement Instruction	Rejection	Settlement on specific account types (i.e. Account Natures, identified with MSA) can only be performed by ESES	Optional: The process is considered optional as it is defined by a CSD for internal static data management purposes	High: The control is based on the implementation of MSAs therefore the impact is high	None: Impact of not implementing is none because the accounts subject to rejection are not held by Investor CSDs		
95	Collateral Management	Interbolsa	SR03 + BL03	Settlement Instruction on securities position	Rejection	Usage of specific securities positions created in the context of bilateral pledge operations (blocked for pledge) is restricted, settlement instructions sent	Optional: Collateral management services are categorised as	Medium: Investor CSDs of Interbolsa can make use of this service. The control requires segregation of securities	None: Blocked positions can be released directly by CSD participants using settlement restrictions		

Id	Business Process	CSD	Control/Restriction rule description ¹⁴¹				Impact Assessment				Additional comments
			Name	Object restriction type	Restriction processing type	Description of the control	Criterion 1 Character of the service / process	Criterion 2 Effort of implementing controls in Investor CSD's structure	Criterion 3 Risk of not implementing controls in Investor CSD's structure	Status	
						by CSD participants on these positions are rejected	optional	positions but not necessarily restriction rules (privileges can be used) and is not needed for the activity as Issuer CSD			
96	Collateral Management	Interbolsa	SR03 + BL04	Settlement Instruction on securities position	Rejection	Usage of specific securities positions created in the context of bilateral pledge operations (blocked for guarantee) is restricted, settlement instructions sent by CSD participants on these positions are rejected	Optional: Collateral management services are categorised as optional	Medium: Investor CSDs of Interbolsa can make use of this service. The control requires segregation of securities positions but not necessarily restriction rules (privileges can be used) and is not needed for the activity as Issuer CSD	None: Blocked positions can be released directly by CSD participants using settlement restrictions		
97	Collateral Management	Interbolsa	SR03 + BL24	Settlement Instruction on securities position	Rejection	Usage of specific securities positions created in the context of pledge to the Portuguese regulator (Investor Compensation Scheme) is restricted, settlement instructions sent by CSD participants on these positions are rejected	Optional: Collateral management services are categorised as optional	Not available: Investor CSDs cannot pledge securities to the Investor Compensation Scheme managed by the Portuguese regulator.			
98	Collateral Management	Interbolsa	SR04 + BL24	Settlement Restriction on securities position	Rejection	Usage of specific securities positions created in the context of pledge to the Portuguese regulator (Investor Compensation Scheme) is restricted, settlement restrictions sent by CSD participants on these positions are rejected	Optional: Collateral management services are categorised as optional	Not available: Investor CSDs cannot pledge securities to the Investor Compensation Scheme managed by the Portuguese regulator.			
99	Collateral Management	Interbolsa	SR03 + BL25	Settlement Instruction on securities	Rejection	Usage of specific securities positions created in the context of pledge to the	Optional: Collateral	Not available: Investor CSDs cannot			

Id	Business Process	CSD	Control/Restriction rule description ¹⁴¹				Impact Assessment				Additional comments
			Name	Object restriction type	Restriction processing type	Description of the control	Criterion 1 Character of the service / process	Criterion 2 Effort of implementing controls in Investor CSD's structure	Criterion 3 Risk of not implementing controls in Investor CSD's structure	Status	
				position		Portuguese regulator (Execution of pledge) is restricted, settlement instructions sent by CSD participants on these positions are rejected	management services are categorised as optional	pledge securities to the Investor Compensation Scheme managed by the Portuguese regulator.			
100	Collateral Management	Interbolsa	SR04 + BL25	Settlement Restriction on securities position	Rejection	Usage of specific securities positions created in the context of pledge to the Portuguese regulator (Execution of pledge) is restricted, settlement restrictions sent by CSD participants on these positions are rejected	Optional: Collateral management services are categorised as optional	Not available: Investor CSDs cannot pledge securities to the Investor Compensation Scheme managed by the Portuguese regulator.			
101	Collateral Management	Interbolsa	SR03 + BL27	Settlement Instruction on securities position	Rejection	Usage of specific securities positions created in the context of pledge to the Portuguese Central Bank (credit operations) is restricted, settlement instructions sent by CSD participants on these positions are rejected	Optional: Collateral management services are categorised as optional	Not available: Investor CSDs cannot pledge securities to the Deposit Guarantee Fund managed by Banco de Portugal for credit operations			
102	Collateral Management	Interbolsa	SR04 + BL27	Settlement Restriction on securities position	Rejection	Usage of specific securities positions created in the context of pledge to the Portuguese Central Bank (credit operations) is restricted, settlement restrictions sent by CSD participants on these positions are rejected	Optional: Collateral management services are categorised as optional	Not available: Investor CSDs cannot pledge securities to the Deposit Guarantee Fund managed by Banco de Portugal for credit operations			
103	Corporate Actions	Interbolsa	RTBS	Security	Blocking	During the processing of certain Corporate Actions, block all settlement instructions in the concerned ISIN, except if sent using "CORP" ISO	Necessary: The service is necessary according to the definition	Low: The control is solely based on the implementation of restriction rules and is generally needed for the	High: The impact is high as not implementing the control could result in settlement of securities that are restricted from		

Id	Business Process	CSD	Control/Restriction rule description ¹⁴¹				Impact Assessment				Additional comments
			Name	Object restriction type	Restriction processing type	Description of the control	Criterion 1 Character of the service / process	Criterion 2 Effort of implementing controls in Investor CSD's structure	Criterion 3 Risk of not implementing controls in Investor CSD's structure	Status	
						transaction code		activity as Issuer CSD	settlement at the Issuer CSD		
104	Corporate Actions	Interbolsa	SR01 + SR02	Settlement Instruction	Rejection	Settlement instructions on outturn temporary ISINs created in the context of rights subscription are rejected, except if using "CORP" or "CLAI" ISO transaction code	Necessary: The service is necessary according to the definition	Low: The control is solely based on the implementation of restriction rules and is generally needed for the activity as Issuer CSD	High: The impact is high as not implementing the control could result in settlement of securities that are restricted from settlement at the Issuer CSD and ownership rights not being exercised		
105	Corporate Actions	Interbolsa	SR03 + BL26	Settlement Instruction on securities position	Rejection	Usage of specific securities positions on which an election has been made as a result of a Voluntary Reorganisation is restricted, settlement instructions sent by CSD participants on these positions are rejected	Necessary: The service is necessary according to the definition	Low: The control requires segregation of securities positions but not necessarily restriction rules (privileges can be used) and is generally needed for the activity as Issuer CSD	High: The impact is high as not implementing the control could result in settlement of securities that are restricted from settlement at the Issuer CSD and ownership rights not being exercised		
106	Corporate Actions	Interbolsa	SR04 + BL26	Settlement Restriction on securities position	Rejection	Usage of specific securities positions on which an election has been made as a result of a Voluntary Reorganisation is restricted, settlement restrictions sent by CSD participants on these positions are rejected	Necessary: The service is necessary according to the definition	Low: The control requires segregation of securities positions but not necessarily restriction rules (privileges can be used) and is generally needed for the activity as Issuer CSD	High: The impact is high as not implementing the control could result in settlement of securities that are restricted from settlement at the Issuer CSD and ownership rights not being exercised		
107	Corporate Actions	Interbolsa	SR03 + EA43	Settlement Instruction on securities position	Rejection	Usage of specific securities positions in temporary ISINs created as a result of rights subscription is restricted, settlement instructions sent by CSD	Necessary: The service is necessary according to the definition	Low: The control requires segregation of securities positions but not necessarily restriction	High: The impact is high as not implementing the control could result in settlement of securities that are		

Id	Business Process	CSD	Control/Restriction rule description ¹⁴¹				Impact Assessment				Additional comments
			Name	Object restriction type	Restriction processing type	Description of the control	Criterion 1 Character of the service / process	Criterion 2 Effort of implementing controls in Investor CSD's structure	Criterion 3 Risk of not implementing controls in Investor CSD's structure	Status	
						participants on these positions are rejected		rules (privileges can be used) and is generally needed for the activity as Issuer CSD	restricted from settlement at the Issuer CSD and ownership rights not being exercised		
108	Corporate Actions	Interbolsa	SR04 + EA43	Settlement Restriction on securities position	Rejection	Usage of specific securities positions in temporary ISINs created as a result of rights subscription is restricted, settlement restrictions sent by CSD participants on these positions are rejected	Necessary: The service is necessary according to the definition	Low: The control requires segregation of securities positions but not necessarily restriction rules (privileges can be used) and is generally needed for the activity as Issuer CSD	High: The impact is high as not implementing the control could result in settlement of securities that are restricted from settlement at the Issuer CSD and ownership rights not being exercised		
109	External Cash Settlement	Interbolsa	CSR01	Settlement Instruction	CoSD Hold	For securities transactions involving cash settlement in currencies not eligible in T2S (i.e. non T2S settlement currencies accepted by the CSD), the securities delivery leg is temporarily blocked in T2S while cash settlement is performed on an external settlement platform	Optional: Cash settlement services in non T2S currencies are considered optional	Not available: Investor CSDs cannot benefit from settlement services in non-T2S currencies provided by the CSD			
110	Investment Funds Processing	Interbolsa	SR03 + BL29	Settlement Instruction on securities position	Rejection	Funds Securities are segregated into specific positions prior to redemption, and settlement instructions sent by CSD participants on these positions are rejected	Optional: Services related to Investment Funds Processing are considered optional	Medium: The control requires segregation of securities positions but not necessarily restriction rules (privileges can be used) and is not needed for the activity as Issuer CSD	High: The impact is high as not implementing the control could result in settlement of securities that are restricted from settlement at the Issuer CSD		The impact on Investor CSDs is deemed limited based on quantitative aspects. Indeed, according to Interbolsa, this service is rarely used, even by domestic participants.
111	Investment Funds	Interbolsa	SR04 + BL29	Settlement Restriction on	Rejection	Funds Securities are segregated into specific	Optional:	Medium:	High:		The impact on Investor CSDs is

Id	Business Process	CSD	Control/Restriction rule description ¹⁴¹				Impact Assessment				Additional comments
			Name	Object restriction type	Restriction processing type	Description of the control	Criterion 1 Character of the service / process	Criterion 2 Effort of implementing controls in Investor CSD's structure	Criterion 3 Risk of not implementing controls in Investor CSD's structure	Status	
	Processing			securities position		positions prior to redemption, and settlement restrictions sent by CSD participants on these positions are rejected	Services related to Investment Funds Processing are considered optional	The control requires segregation of securities positions but not necessarily restriction rules (privileges can be used) and is not needed for the activity as Issuer CSD	The impact is high as not implementing the control could result in settlement of securities that are restricted from settlement at the Issuer CSD		deemed limited based on quantitative aspects. Indeed, according to Interbolsa, this service is rarely used, even by domestic participants.
112	Non-standardised securities	Interbolsa	SR03 + BL02	Settlement Instruction on securities position	Rejection	In case of withdrawal from the vaults, physical securities are blocked in a specific position until the participant has taken physical ownership of the security. Settlement instructions sent by CSD participants debiting this blocked position are rejected	Optional: Services related to Non-Standardised Securities are considered optional	Medium: The control requires segregation of securities positions but not necessarily restriction rules (privileges can be used) and is not needed for the activity as Issuer CSD	High: The impact is high as not implementing the control could result in settlement of securities that are restricted from settlement at the Issuer CSD		The impact on Investor CSDs is deemed limited based on quantitative aspects: the scenario would require an Investor CSD participant physically withdrawing securities at Interbolsa
113	Non-standardised securities	Interbolsa	SR04 + BL02	Settlement Restriction on securities position	Rejection	In case of withdrawal from the vaults, physical securities are blocked in a specific position until the participant has taken physical ownership of the security. Settlement Restrictions sent by CSD participants on this blocked position are rejected	Optional: Services related to Non-Standardised Securities are considered optional	Medium: The control requires segregation of securities positions but not necessarily restriction rules (privileges can be used) and is not needed for the activity as Issuer CSD	High: The impact is high as not implementing the control could result in settlement of securities that are restricted from settlement at the Issuer CSD		The impact on Investor CSDs is deemed limited based on quantitative aspects: the scenario would require an Investor CSD participant physically withdrawing securities at Interbolsa
114	Other Regulatory Compliance	Interbolsa	SR03 + BL10	Settlement Instruction on securities position	Rejection	Upon enforcement of a Court Order, specific securities positions may be restricted, settlement instructions sent by CSD participants on these positions are rejected	Necessary: The service is necessary according to the definition	Low: The control requires segregation of securities positions but not necessarily restriction rules (privileges can be used) and is generally	High: Impact is high because potentially not complying with regulatory requirements if the restriction is not		Segregation in specific securities position is only done upon request of the Investor CSD. It is therefore assumed that this segregation

Id	Business Process	CSD	Control/Restriction rule description ¹⁴¹				Impact Assessment				Additional comments
			Name	Object restriction type	Restriction processing type	Description of the control	Criterion 1 Character of the service / process	Criterion 2 Effort of implementing controls in Investor CSD's structure	Criterion 3 Risk of not implementing controls in Investor CSD's structure	Status	
								needed for the activity as Issuer CSD	applied.		is required as Issuer CSD
115	Static Data Configuration	Interbolsa	SR03 + BL09	Settlement Instruction on securities position	Rejection	Securities may be blocked in a specific securities position, settlement instructions sent by CSD participants debiting this position are rejected. This restricted position type is currently not planned for a specific process	Optional: The process is considered optional as it is defined by a CSD for internal static data management purposes	Low: The control requires segregation of securities positions but not necessarily restriction rules (privileges can be used) and is needed for the activity as Issuer CSD	High: The impact is high as not implementing the control could result in settlement of securities that are restricted from settlement at the Issuer CSD		Segregation in specific securities position is only done upon request of the Investor CSD. It is therefore assumed that this segregation is required as Issuer CSD
116	Static Data Configuration	Interbolsa	BL11	Securities position	Reservation	Securities are blocked in a specific position at the request of the participant. This segregation is planned for generic settlement management	Optional: The process is considered optional as it is defined by a CSD for internal static data management purposes	Low: The control requires segregation of securities positions but not necessarily restriction rules (privileges can be used) and is needed for the activity as Issuer CSD	High: The impact is high as not implementing the control could result in settlement of securities that are restricted from settlement at the Issuer CSD		Segregation in specific securities position is only done upon request of the Investor CSD. It is therefore assumed that this segregation is required as Issuer CSD
117	Static Data Configuration	Interbolsa	RE35	Securities position	Reservation	Securities are reserved in a specific position at the request of the participant. This segregation is planned for generic settlement management	Optional: The process is considered optional as it is defined by a CSD for internal static data management purposes	Low: The control requires segregation of securities positions but not necessarily restriction rules (privileges can be used) and is needed for the activity as Issuer CSD	High: The impact is high as not implementing the control could result in settlement of securities that are restricted from settlement at the Issuer CSD		Segregation in specific securities position is only done upon request of the Investor CSD. It is therefore assumed that this segregation is required as Issuer CSD
118	Static Data Configuration	Interbolsa	EA40	Settlement Instruction on securities position	Earmarking	Securities are earmarked in a specific position at the request of the participant. This segregation is planned for generic settlement management	Optional: The process is considered optional as it is defined by a CSD for internal static data management purposes	Low: The control requires segregation of securities positions but not necessarily restriction rules (privileges can be used) and is needed for the activity as Issuer	High: The impact is high as not implementing the control could result in settlement of securities that are restricted from settlement at the Issuer CSD		Segregation in specific securities position is only done upon request of the Investor CSD. It is therefore assumed that this segregation is required as Issuer

Id	Business Process	CSD	Control/Restriction rule description ¹⁴¹				Impact Assessment				Additional comments
			Name	Object restriction type	Restriction processing type	Description of the control	Criterion 1 Character of the service / process	Criterion 2 Effort of implementing controls in Investor CSD's structure	Criterion 3 Risk of <u>not</u> implementing controls in Investor CSD's structure	Status	
								CSD			CSD
119	Static Data Configuration	KDD	C101 + C102	Settlement Restriction	Rejection	All settlement restrictions sent by CSD participants are rejected with the exception of T2S generated settlement restrictions for Conditional Securities Delivery (COSP)	Optional: The process is considered optional as it is defined by a CSD for internal static data management purposes	Not available: Segregation of securities positions by blocking and reservation restriction types is not available to participants of KDD, including Investor CSDs			
120	Corporate Actions	KDD	C201	Security	Blocking	During the processing of certain Corporate Actions, block all settlement instructions in the concerned ISIN, except if sent using "CORP" ISO transaction code.	Necessary: The service is necessary according to the definition.	Low: The control is solely based on the implementation of restriction rules and is needed for the activity as Issuer CSD.	High: The impact is high as not implementing the control could result in settlement of securities that are restricted from settlement at the Issuer CSD.		
121	Issuance	KDD	C103	Settlement Instruction	Rejection	In the case of Issuance, Receiving Settlement Instructions sent by Distributing Agents on Distribution Accounts with "Securities Movement Restriction = DELI" (identified with MSA) are rejected when instructed by DCPs. In the case of Redemption, Delivering Settlement Instructions sent by Distributing Agents on Distribution Accounts with "Securities Movement Restriction = RECE" (identified with MSA) are rejected when instructed by DCPs.	Optional: Issuance services are considered optional.	High: The control is based on the implementation of MSAs therefore the impact is high.	None: The impact is none because Distributing Agents are KDD's participants and the process is transparent for Investor CSDs.		Independently of acting as Issuer CSD or Investor CSD, the use of Distribution Accounts in T2S (three tiered issuance model) requires specific controls to be put in place in the form of MSAs and/or restriction rules, i.e. these are not part of T2S pre-configured built-in functionality. Note: This restriction rule will be slighted amended so that only SIs sent by DCPs are rejected. This will be

Id	Business Process	CSD	Control/Restriction rule description ¹⁴¹				Impact Assessment				Additional comments
			Name	Object restriction type	Restriction processing type	Description of the control	Criterion 1 Character of the service / process	Criterion 2 Effort of implementing controls in Investor CSD's structure	Criterion 3 Risk of not implementing controls in Investor CSD's structure	Status	
											reflected in the next Reference Data Extension update.
122	Operational Procedures	KDD	C202	Security	Blocking	In the event of reconciliation errors, all settlement instructions on a given ISIN are blocked.	Necessary: The process is considered necessary as operational procedures shall be defined by an Issuer CSD to ensure the management of operational risk on the settlement platform for all its participants, including Investor CSDs.	Low: The control is solely based on the implementation of restriction rules and is generally needed for the activity as Issuer CSD.	High: The impact is high as not implementing the control could result in settlement of securities that are restricted from settlement at the Issuer CSD.		Mandated by the CSDR Level 2 Technical Standards on CSD Requirements, Article 86(2).
123	Other Regulatory Compliance	KDD	C203	Securities Account	Blocking	All settlement instructions on a given securities account are blocked upon request of the competent authority, except for settlement instructions sent by KDD.	Necessary: The service is necessary according to the definition.	Low: The control is solely based on the implementation of restriction rules and is generally needed for the activity as Issuer CSD.	High: Impact is high because potentially not complying with regulatory requirements (in the case where the participant is also participant of the Investor CSD).		
124	Collateral Management	KELER	RT09_R restricted _Balance + BL01	Settlement Instruction on securities positions	Rejection	Usage of specific securities positions created in the context of unilateral and joint blocking pledge operations is restricted, settlement instructions sent by CSD participants on these positions are rejected	Optional: The service is optional according to the definition	Medium: The control requires segregation of securities positions but not necessarily restriction rules (privileges can be used) and is not needed for the activity as Issuer CSD	High: The impact is high as not implementing the control could result in settlement of securities that are restricted from settlement at the Issuer CSD		

Id	Business Process	CSD	Control/Restriction rule description ¹⁴¹				Impact Assessment				Additional comments
			Name	Object restriction type	Restriction processing type	Description of the control	Criterion 1 Character of the service / process	Criterion 2 Effort of implementing controls in Investor CSD's structure	Criterion 3 Risk of <u>not</u> implementing controls in Investor CSD's structure	Status	
125	Collateral Management	KELER	RT09_R estricted _Balance + BL01	Settlement restriction on securities positions	Rejection	Usage of specific securities positions created in the context of unilateral and joint blocking pledge operations is restricted, settlement restrictions sent by CSD participants on these positions are rejected	Optional: The service is optional according to the definition	Medium: The control requires segregation of securities positions but not necessarily restriction rules (privileges can be used) and is not needed for the activity as Issuer CSD	High: The impact is high as not implementing the control could result in settlement of securities that are restricted from settlement at the Issuer CSD		
126	Collateral Management	KELER	RT09_R estricted _Balance + BL02	Settlement Instruction on securities positions	Rejection	Usage of specific securities positions created in the context of bi-lateral and trilateral blocking pledge operations is restricted, settlement instructions sent by CSD participants on these positions are rejected	Optional: The service is optional according to the definition	Medium: The control requires segregation of securities positions but not necessarily restriction rules (privileges can be used) and is not needed for the activity as Issuer CSD	High: The impact is high as not implementing the control could result in settlement of securities that are restricted from settlement at the Issuer CSD		
127	Collateral Management	KELER	RT09_R estricted _Balance + BL02	Settlement restriction on securities positions	Rejection	Usage of specific securities positions created in the context of bi-lateral and trilateral blocking pledge operations is restricted, settlement restrictions sent by CSD participants on these positions are rejected	Optional: The service is optional according to the definition	Medium: The control requires segregation of securities positions but not necessarily restriction rules (privileges can be used) and is not needed for the activity as Issuer CSD	High: The impact is high as not implementing the control could result in settlement of securities that are restricted from settlement at the Issuer CSD		
128	Collateral Management	KELER	RT09_R estricted _Balance + BL03	Settlement Instruction on securities positions	Rejection	Usage of specific securities positions created in the context of generic collateral operations is restricted, settlement instructions sent by CSD participants on these positions are rejected	Optional: The service is optional according to the definition	Medium: The control requires segregation of securities positions but not necessarily restriction rules (privileges can be used) and is not needed for the activity as Issuer CSD	High: The impact is high as not implementing the control could result in settlement of securities that are restricted from settlement at the Issuer CSD		

Id	Business Process	CSD	Control/Restriction rule description ¹⁴¹				Impact Assessment				Additional comments
			Name	Object restriction type	Restriction processing type	Description of the control	Criterion 1 Character of the service / process	Criterion 2 Effort of implementing controls in Investor CSD's structure	Criterion 3 Risk of <u>not</u> implementing controls in Investor CSD's structure	Status	
129	Collateral Management	KELER	RT09_R estricted _Balance + BL03	Settlement restriction on securities positions	Rejection	Usage of specific securities positions created in the context of generic collateral operations is restricted, settlement restrictions sent by CSD participants on these positions are rejected	Optional:	Medium: The control requires segregation of securities positions but not necessarily restriction rules (privileges can be used) and is not needed for the activity as Issuer CSD	High: The impact is high as not implementing the control could result in settlement of securities that are restricted from settlement at the Issuer CSD		
130	Collateral Management	KELER	RT09_R estricted _Balance + BL04	Settlement Instruction on securities positions	Rejection	Usage of specific securities positions created in the context of hold-in repo operations is restricted, settlement instructions sent by CSD participants on these positions are rejected	The service is optional according to the definition	Medium: The control requires segregation of securities positions but not necessarily restriction rules (privileges can be used) and is not needed for the activity as Issuer CSD	High: The impact is high as not implementing the control could result in settlement of securities that are restricted from settlement at the Issuer CSD		
131	Collateral Management	KELER	RT09_R estricted _Balance + BL04	Settlement restriction on securities positions	Rejection	Usage of specific securities positions created in the context of hold-in repo operations is restricted, settlement restrictions sent by CSD participants on these positions are rejected	Optional: The service is optional according to the definition	Medium: The control requires segregation of securities positions but not necessarily restriction rules (privileges can be used) and is not needed for the activity as Issuer CSD	High: The impact is high as not implementing the control could result in settlement of securities that are restricted from settlement at the Issuer CSD		
132	Corporate Actions	KELER	RT05_Se curity_R eject	Settlement instruction	Rejection	Settlement instructions on securities with status" in capture", "suspended", "to be deleted", "redeemed", "deleted" (identified with MSA) are rejected, unless instructed with the ISO transaction code "CORP"	Necessary: The service is necessary according to the definition	High: The control is based on the implementation of MSAs therefore the impact is high	High: The impact is high as not implementing the control could result in settlement of securities that are restricted from settlement at the Issuer CSD		
133	Corporate	KELER	RT05_Se curity_R	Settlement	Rejection	Settlement restrictions on securities with status "in	Necessary:	High:	None:		

Id	Business Process	CSD	Control/Restriction rule description ¹⁴¹				Impact Assessment				Additional comments
			Name	Object restriction type	Restriction processing type	Description of the control	Criterion 1 Character of the service / process	Criterion 2 Effort of implementing controls in Investor CSD's structure	Criterion 3 Risk of not implementing controls in Investor CSD's structure	Status	
	Actions		reject	restriction		capture", "suspended", "to be deleted", "redeemed", "deleted" (identified with MSA) are rejected	The service is necessary according to the definition	The control is based on the implementation of MSAs therefore the impact is high	Cross-CSD transactions will not be impacted as only intra-position movements within an account on a security with the afore mentioned statuses will be subject to rejection		
134	Corporate Actions	KELER	RT06_Security_Block	Security	Blocking	During the processing of certain Corporate Actions, block all settlement instructions in the concerned ISIN, except if sent using "CORP" ISO transaction code	Necessary: The service is necessary according to the definition	Low: The control is solely based on the implementation of restriction rules and is needed for the activity as Issuer CSD	High: The impact is high as not implementing the control could result in settlement of securities that are restricted from settlement at the Issuer CSD		
135	External Cash Settlement	KELER	RT08_External_Cash	Settlement instruction	CoSD	For securities transactions involving cash settlement in currencies not eligible in T2S (i.e. non T2S settlement currencies accepted by the CSD), the securities leg is temporarily blocked in T2S until cash settlement is performed on an external settlement platform	Optional: Cash settlement services in non T2S currencies are considered optional	Medium: The control is solely based on the implementation of a CoSD rule, and this control is not necessarily needed as Issuer CSD	High: Not implementing the control could result in undue settlement of securities, i.e. transaction settles as normal FOP instead of DVP with non-T2S currency		
136	Insolvency Procedures	KELER	RT01_Party_Reject	Settlement instruction	Rejection	Settlement instructions on parties with status "suspended" or "to be deleted" (identified with MSA) are rejected, except for settlement instructions sent using the "CORP" ISO transaction code	Necessary: The service is necessary according to the definition	High: The control is based on the implementation of MSAs therefore the impact is high	High: Impact of not implementing is high because potentially not complying with regulatory requirements depending on the scope of the suspension (in the case where the participant is also participant of the		

Id	Business Process	CSD	Control/Restriction rule description ¹⁴¹				Impact Assessment				Additional comments
			Name	Object restriction type	Restriction processing type	Description of the control	Criterion 1 Character of the service / process	Criterion 2 Effort of implementing controls in Investor CSD's structure	Criterion 3 Risk of not implementing controls in Investor CSD's structure	Status	
									Investor CSD)		
137	Insolvency Procedures	KELER	RT01_Party_Reject	Settlement restriction	Rejection	Settlement restrictions on parties with status "suspended" or "to be deleted" (identified with MSA) are rejected	Necessary: The service is necessary according to the definition	High: The control is based on the implementation of MSAs therefore the impact is high	None: Cross-CSD transactions will not be impacted as only intra-position movements between parties with status "suspended" or "to be deleted" will be subject to rejection		
138	Insolvency Procedures	KELER	RT02_Party_Block	Party	Blocking	In the context of insolvency, all settlement instructions for a particular party are blocked upon request of the competent authorities, unless instructed with the ISO transaction code "CORP".	Necessary: The service is necessary according to the definition	Low: The control is solely based on the implementation of restriction rules and is needed for the activity as Issuer CSD	High: Impact is high because potentially not complying with regulatory requirements depending on the scope of the suspension (in the case where the participant is also participant of the Investor CSD)		
139	Insolvency Procedures	KELER	RT03_Account_Reject	Settlement instruction	Rejection	Settlement on accounts with status "suspended", "frozen", "dormant", or "to be deleted" (identified with MSA) are rejected, except for settlement instructions sent using the "CORP" ISO transaction code.	Necessary: The service is necessary according to the definition	High: The control is based on the implementation of MSAs therefore the impact is high	High: Impact of not implementing is high because potentially not complying with regulatory requirements depending on the scope of the suspension (in the case where the participant is also participant of the Investor CSD)		
140	Insolvency Procedures	KELER	RT03_Account_Reject	Settlement restriction	Rejection	Settlement restrictions on accounts with status "suspended", "frozen", "dormant", or "to be deleted" (identified with	Necessary: The service is necessary according to the	High: The control is based on the implementation of MSAs therefore the	None: Cross-CSD transactions will not be impacted as only intra-position		

Id	Business Process	CSD	Control/Restriction rule description ¹⁴¹				Impact Assessment				Additional comments
			Name	Object restriction type	Restriction processing type	Description of the control	Criterion 1 Character of the service / process	Criterion 2 Effort of implementing controls in Investor CSD's structure	Criterion 3 Risk of not implementing controls in Investor CSD's structure	Status	
						MSA) are rejected	definition	impact is high	movements between parties with status "suspended", "frozen", "dormant", or "to be deleted" will be subject to rejection		
141	Insolvency Procedures	KELER	RT04_Account_Block	Account	Blocking	In the context of insolvency, all settlement instructions for a specific securities account are blocked upon request of the competent authorities.	Necessary: The service is necessary according to the definition	Low: The control is solely based on the implementation of restriction rules and is needed for the activity as Issuer CSD	High: Impact is high because potentially not complying with regulatory requirements depending on the scope of the suspension (in the case where the participant is also participant of the Investor CSD)		
142	Non-Standardised Securities	KELER	RT07_Non-standardised_Secur	Settlement instruction	CSD Validation Hold	Settlement instructions on accounts flagged as "certificate" (identified with MSA) are put on CSD validation hold so that KELER can perform the necessary validations	Optional: Services related to Non-Standardised Securities are considered optional	High: The control is based on the implementation of MSAs therefore the impact is high	High: Impact is high as not implementing the control could result in a discrepancy between actual and "registered" owner of non-standardised securities		The impact on Investor CSDs is deemed very limited based on quantitative aspects. Indeed, according to KELER, non-standardised securities are very illiquid securities representing a low volume/amount of transactions.
143	Non-Standardised Securities	KELER	RT07_Non-standardised_Secur	Settlement restriction	Rejection	Settlement restrictions on accounts flagged as "certificate" (identified with MSA) are rejected	Optional: Services related to Non-Standardised Securities are considered optional	High: The control is based on the implementation of MSAs therefore the impact is high	None: Cross-CSD transactions will not be impacted as only intra-position movements within an account will be subject to rejection		
144	Static Data	KELER	RT01_Pa	Settlement	Rejection	Settlement instructions on	Optional:	High:	None:		

Id	Business Process	CSD	Control/Restriction rule description ¹⁴¹				Impact Assessment				Additional comments
			Name	Object restriction type	Restriction processing type	Description of the control	Criterion 1 Character of the service / process	Criterion 2 Effort of implementing controls in Investor CSD's structure	Criterion 3 Risk of not implementing controls in Investor CSD's structure	Status	
	Configuration		rty_Reject	instruction		parties with status "in capture", "to be deleted" or "deleted" (identified with MSA) are rejected, except for settlement instructions sent using the "CORP" ISO transaction code ¹⁴² .	The process is considered optional as it is defined by a CSD for internal static data management purposes.	The control is based on the implementation of MSAs therefore the impact is high.	No impact since this restriction is used by the CSD to manage the creation/deletion of a party. Only after all validations are successfully processed, the party can be created/deleted. This internal process does not have an impact on Investor CSDs.		
145	Static Data Configuration	KELER	RT01_Party_Reject	Settlement restriction	Rejection	Settlement restrictions on parties with status "in capture", "to be deleted" or "deleted" (identified with MSA) are rejected.	Optional: The process is considered optional as it is defined by a CSD for internal static data management purposes.	High: The control is based on the implementation of MSAs therefore the impact is high.	None: Cross-CSD transactions will not be impacted as only intra-position movements between parties with status "suspended" or "to be deleted" will be subject to rejection		
146	Static Data Configuration	KELER	RT03_Account_Reject	Settlement instruction	Rejection	Settlement instructions on securities accounts with status "in capture", "to be deleted" or "deleted" (identified with MSA) are rejected. ¹⁴³	Optional: The process is considered optional as it is defined by a CSD for internal static data management purposes.	High: The control is based on the implementation of MSAs therefore the impact is high.	None: No impact since this restriction is used by the CSD to manage the creation/deletion of an account. Only after all validations are successfully processed, the account can be created/deleted. This internal process does not have an impact on		

¹⁴² CORP exception is only valid for bypassing settlement instructions when the account has the value "To Be Deleted".

¹⁴³ CORP exception is only valid for bypassing settlement instructions when the account has the value "To Be Deleted".

Id	Business Process	CSD	Control/Restriction rule description ¹⁴¹				Impact Assessment				Additional comments
			Name	Object restriction type	Restriction processing type	Description of the control	Criterion 1 Character of the service / process	Criterion 2 Effort of implementing controls in Investor CSD's structure	Criterion 3 Risk of <u>not</u> implementing controls in Investor CSD's structure	Status	
									Investor CSDs.		
147	Static Data Configuration	KELER	RT03_Account_Reject	Settlement restriction	Rejection	Settlement restrictions on securities accounts with status "in capture", "to be deleted" or "deleted" (identified with MSA) are rejected	Optional: The process is considered optional as it is defined by a CSD for internal static data management purposes	High: The control is based on the implementation of MSAs therefore the impact is high	None: Cross-CSD transactions will not be impacted as only intra-position movements between parties with status "suspended" or "to be deleted" will be subject to rejection		
148	Collateral Management	Monte Titoli	RXCI+BXCM	Settlement Instruction on securities position	Rejection	Specific securities positions are created in the context of triparty collateral management before being mobilised, settlement instructions sent by CSD participants on these positions are rejected	Optional: The service is optional according to the definition	Medium: The service requires segregation of securities positions in a dedicated account but not restriction rules (privileges can be used) and this segregation is not needed for the activity as Issuer CSD	High: The impact is high as not implementing the control (i.e. segregation of eligible collateral) could result in undue settlement of securities (mobilisation of securities on omnibus account not belonging to the participant to the triparty collateral management system).		To minimise the risk described in criterion 3, Monte Titoli recommends to use a dedicated account for triparty eligible collateral
149	Collateral Management	Monte Titoli	RXCR+BXCM	Settlement Restriction on securities position	Rejection	Specific securities positions are created in the context of triparty collateral management before being mobilised, settlement restrictions sent by CSD participants on these positions are rejected	Optional: The service is optional according to the definition	Medium: The service requires segregation of securities positions in a dedicated account but not restriction rules (privileges can be used) and this segregation is not needed for the activity as Issuer CSD	High: The impact is high as not implementing the control (i.e. segregation of eligible collateral) could result in undue settlement of securities (mobilisation of securities on omnibus account not belonging to the participant to the triparty collateral management system).		To minimise the risk described in criterion 3, Monte Titoli recommends to use a dedicated account for triparty eligible collateral
150	Corporate	Monte	RBCA	Security	Blocking	During the processing of certain Corporate Actions,	Necessary:	Low:	High:		

Id	Business Process	CSD	Control/Restriction rule description ¹⁴¹				Impact Assessment				Additional comments
			Name	Object restriction type	Restriction processing type	Description of the control	Criterion 1 Character of the service / process	Criterion 2 Effort of implementing controls in Investor CSD's structure	Criterion 3 Risk of not implementing controls in Investor CSD's structure	Status	
	Actions	Titoli				block all settlement instructions in the concerned ISIN, except if sent using "CORP" ISO transaction code	The service is necessary according to the definition	The control is solely based on the implementation of restriction rules and is generally needed for the activity as Issuer CSD	The impact is high as not implementing the control could result in settlement of securities that are restricted from settlement at the Issuer CSD		
151	Corporate Actions	Monte Titoli	RC1I + CUS1	Settlement Instruction on securities position	Rejection	Usage of specific securities positions created in the context of elective CA is restricted, settlement instructions sent by CSD participants on these positions are rejected	Necessary: The service is necessary according to the definition	Low: The control requires segregation of securities positions but not necessarily restriction rules (privileges can be used) and is generally needed for the activity as Issuer CSD	High: The impact is high as not implementing the control could result in settlement of securities that are restricted from settlement at the Issuer CSD and ownership rights not being exercised		
152	Corporate Actions	Monte Titoli	RC1R + CUS1	Settlement Restriction on securities position	Rejection	Usage of specific securities positions created in the context of elective CA is restricted, settlement restrictions sent by CSD participants on these positions are rejected	Necessary: The service is necessary according to the definition	Low: The control requires segregation of securities positions but not necessarily restriction rules (privileges can be used) and is generally needed for the activity as Issuer CSD	High: The impact is high as not implementing the control could result in settlement of securities that are restricted from settlement at the Issuer CSD and ownership rights not being exercised		
153	Corporate Actions	Monte Titoli	RC2I + CUS2	Settlement Instruction on securities position	Rejection	Usage of specific securities positions created in the context of CA operations (e.g. split, withdrawal) on physical securities is restricted, settlement instructions sent by CSD participants on these positions are rejected	Necessary: The service is necessary according to the definition	Low: The control can solely be based on segregation of securities positions (privileges can be used instead of restriction rules) or restriction rules and is generally needed for the activity as Issuer CSD	None: As the control can be implemented with a blocking on the ISIN level, there is no impact		

Id	Business Process	CSD	Control/Restriction rule description ¹⁴¹				Impact Assessment				Additional comments
			Name	Object restriction type	Restriction processing type	Description of the control	Criterion 1 Character of the service / process	Criterion 2 Effort of implementing controls in Investor CSD's structure	Criterion 3 Risk of <u>not</u> implementing controls in Investor CSD's structure	Status	
154	Corporate Actions	Monte Titoli	RC2R + CUS2	Settlement Restriction on securities position	Rejection	Usage of specific securities positions created in the context of CA operations (e.g. split, withdrawal) on physical securities is restricted, settlement restrictions sent by CSD participants on these positions are rejected	Necessary: The service is necessary according to the definition	Low: The control can solely be based on segregation of securities positions (privileges can be used instead of restriction rules) or restriction rules and is generally needed for the activity as Issuer CSD	None: As the control can be implemented with a blocking on the ISIN level, there is no impact		
155	Corporate Actions	Monte Titoli	VHEC + EXCM	Settlement Instruction on securities position	CSD Validation Hold (CVAL)	Usage of specific securities positions created due to Germany's non-compliance to key CA dates (ex/cum) for certain events is restricted, settlement instructions sent by CSD participants on these positions are put on CVAL	Not assessed:	Not assessed:	Not assessed:		Controls defined as Investor CSD of a CSD in T2S are not assessed
156	Corporate Actions	Monte Titoli	REXR + EXCM	Settlement Instruction on securities position	Rejection	Usage of specific securities positions created due to Germany's non-compliance to key CA dates (ex/cum) for certain events is restricted, settlement restrictions sent by CSD participants on these positions are rejected	Not assessed:	Not assessed:	Not assessed:		Controls defined as Investor CSD of a CSD in T2S are not assessed
157	External CSD Settlement	Monte Titoli	CEXT	Settlement Instruction	CoSD Hold	For cross-CSD transactions involving a CSD external to T2S, the securities leg of the transaction is temporarily blocked until an external settlement condition has been fulfilled i.e. cash or securities settlement leg outside T2S	Optional: The service is considered optional as Monte Titoli is acting as Investor CSD of an External CSD and not as Issuer CSD, i.e. triggering the CoSD rule only in	Medium: The control is solely based on the implementation of a CoSD rule and is not needed for the activity as Issuer CSD	High: Not implementing the control could result in undue settlement of securities, i.e. DVP is not ensured		Monte Titoli mentioned that they currently do not have any Investor CSD using them to access securities issued outside T2S

Id	Business Process	CSD	Control/Restriction rule description ¹⁴¹				Impact Assessment				Additional comments	
			Name	Object restriction type	Restriction processing type	Description of the control	Criterion 1 Character of the service / process	Criterion 2 Effort of implementing controls in Investor CSD's structure	Criterion 3 Risk of not implementing controls in Investor CSD's structure	Status		
							the case where the Issuer CSD is outside T2S.					
158	Insolvency Procedures	Monte Titoli	BLSC	Security	Blocking	Settlement instructions on a specific ISIN are blocked due to events such as (but not exclusively) default of a participant (issuer or intermediary), judicial authority instruction.	Necessary: The service is necessary according to the definition	Low: The control is solely based on the implementation of restriction rules and is generally needed for the activity as Issuer CSD	High: Impact is high because potentially not complying with regulatory requirements depending on the scope of the suspension, i.e. if it is applicable in the domestic jurisdiction of the Investor CSD			
159	Insolvency Procedures	Monte Titoli	BLSY	Party	Blocking	Settlement instructions of a specific T2S party are blocked due to events such as (but not exclusively) default of a participant (issuer or intermediary), judicial authority instruction.	Necessary: The service is necessary according to the definition	Low: The control is solely based on the implementation of restriction rules and is generally needed for the activity as Issuer CSD	High: Impact is high because potentially not complying with regulatory requirements depending on the scope of the suspension, i.e. if it is applicable in the domestic jurisdiction of the Investor CSD (for intra-CSD transactions when the suspended participant is also participant of the Investor CSD)			
160	Insolvency Procedures	Monte Titoli	BLSA	Securities Account	Blocking	Settlement instructions on a specific securities account are blocked due to events such as (but not exclusively) default of a participant (issuer or intermediary), judicial authority instruction.	Necessary: The service is necessary according to the definition	Low: The control is solely based on the implementation of restriction rules and is generally needed for the activity as Issuer CSD	High: Impact is high because potentially not complying with regulatory requirements depending on the scope of the suspension, i.e. if it is applicable in the domestic jurisdiction of the Investor CSD (for			

Id	Business Process	CSD	Control/Restriction rule description ¹⁴¹				Impact Assessment				Additional comments
			Name	Object restriction type	Restriction processing type	Description of the control	Criterion 1 Character of the service / process	Criterion 2 Effort of implementing controls in Investor CSD's structure	Criterion 3 Risk of not implementing controls in Investor CSD's structure	Status	
									intra-CSD transactions when the suspended participant is also participant of the Investor CSD)		
161	Other Regulatory Compliance	Monte Titoli	RVPI	Settlement Instruction	Rejection	Interim ISINS (identified with MSA) created as a result from the exercise of a dividend postponement can only be transferred FOP	Necessary: The service is necessary according to the definition	High: The control is based on the implementation of MSAs therefore the impact is high	High: Impact is high because not complying with regulatory requirements if the restriction is not applied.		Based on quantitative aspects, impact on Investor CSDs should be limited. Indeed, postponement of dividend for tax reasons is not generally chosen by Investor CSDs according to Monte Titoli.
162	Static Data Configuration	Monte Titoli	BLK	Securities position	Blocking	Securities are blocked in a specific position at the request of the participant. This segregation is planned for generic settlement management	Optional: The process is considered optional as it is defined by a CSD for internal static data management purposes	Low: The control requires segregation of securities positions and is needed for the activity as Issuer CSD	High: The impact is high as not implementing the control could result in settlement of securities that are restricted from settlement at the Issuer CSD		Segregation in specific securities position is only done upon request of the Investor CSD. It is therefore assumed that this segregation is required as Issuer CSD
163	Static Data Configuration	Monte Titoli	EAR1	Securities position	Earmarking	Securities are earmarked in a specific position at the request of the participant. This segregation is not planned for a specific process	Optional: The process is considered optional as it is defined by a CSD for internal static data management purposes	Low: The control requires segregation of securities positions and is needed for the activity as Issuer CSD	High: The impact is high as not implementing the control could result in settlement of securities that are restricted from settlement at the Issuer CSD		Segregation in specific securities position is only done upon request of the Investor CSD. It is therefore assumed that this segregation is required as Issuer CSD
164	Static Data Configuration	Monte Titoli	RES1	Securities position	Reservation	Securities are reserved in a specific position at the request of the participant. This segregation is not planned for a specific	Optional: The process is considered optional as it is	Low: The control requires segregation of securities positions and is needed	High: The impact is high as not implementing the control could result in settlement		Segregation in specific securities position is only done upon request of the Investor CSD. It is

Id	Business Process	CSD	Control/Restriction rule description ¹⁴¹				Impact Assessment				Additional comments
			Name	Object restriction type	Restriction processing type	Description of the control	Criterion 1 Character of the service / process	Criterion 2 Effort of implementing controls in Investor CSD's structure	Criterion 3 Risk of not implementing controls in Investor CSD's structure	Status	
						process	defined by a CSD for internal static data management purposes	for the activity as Issuer CSD	of securities that are restricted from settlement at the Issuer CSD		therefore assumed that this segregation is required as Issuer CSD
165	Collateral Management	NBB-SSS	NBBE-RT02	Settlement Instruction	CSD Validation Hold (CVAL)	Settlement instructions on pledge securities accounts (identified with MSA) are put on CVAL until authorisation is provided by the pledgee that the collateral is eligible	Optional: Collateral management services are categorised as optional	High: The control is based on the implementation of MSAs therefore the impact is high	Medium: Impact is medium as cross-CSD transactions could be pending and require bilateral cancellation of the settlement instructions		
166	Insolvency Procedures	NBB-SSS	NBBE-RT10	Settlement Instruction	CSD Validation Hold (CVAL)	As a result of regulatory requirements or upon enforcement of a court order, settlement instructions of a specific CSD participant (party) are put on CVAL	Necessary: The service is necessary according to the definition	High: The control is based on the implementation of MSAs therefore the impact is high	High: Impact is high because potentially not complying with regulatory requirements depending on the scope of the suspension, i.e. if it is applicable in the domestic jurisdiction of the Investor CSD (for intra-CSD transactions when the suspended participant is also participant of the Investor CSD)		
167	Insolvency Procedures	NBB-SSS	NBBE-RT11	Settlement Instruction	CSD Validation Hold (CVAL)	As a result of regulatory requirements or upon enforcement of a court order, settlement instructions on a specific ISIN are put on CVAL	Necessary: The service is necessary according to the definition	High: The control is based on the implementation of MSAs therefore the impact is high	High: Impact is high because not complying with regulatory requirements depending on the scope of the suspension, i.e. if it is applicable in the domestic jurisdiction of the Investor CSD		
168	Insolvency Procedures	NBB-SSS	NBBE-RT12	Settlement Instruction	CSD Validation Hold	As a result of regulatory requirements or upon enforcement of a court	Necessary: The service is	High: The control is based on	High: Impact is high because		

Id	Business Process	CSD	Control/Restriction rule description ¹⁴¹				Impact Assessment				Additional comments
			Name	Object restriction type	Restriction processing type	Description of the control	Criterion 1 Character of the service / process	Criterion 2 Effort of implementing controls in Investor CSD's structure	Criterion 3 Risk of not implementing controls in Investor CSD's structure	Status	
					(CVAL)	order, settlement instructions on a specific securities account are put on CVAL	necessary according to the definition	the implementation of MSAs therefore the impact is high	not complying with regulatory requirements depending on the scope of the suspension, i.e. if it is applicable in the domestic jurisdiction of the Investor CSD (for intra-CSD transactions when the suspended participant is also participant of the Investor CSD)		
169	Taxation	NBB-SSS	NBBE-RT01	Settlement Instruction	Rejection	Securities exempted from Belgian withholding tax (identified with MSA Securities WT Type) cannot be held on non-exempted securities accounts (identified with MSA Account WT type). Borrowing of securities, repurchase agreements, swap of securities, and exchange of securities cannot be performed with securities held on non-exempted accounts	Necessary: The service is necessary according to the definition	High: The control is based on the implementation of MSAs therefore the impact is high	High: Impact of not implementing is high because potentially not complying with fiscal requirements		
170	Taxation	NBB-SSS	NBBE-RT02	Settlement Instruction	CSD Validation Hold (CVAL)	Settlement instructions from CSD participants on securities (identified with MSA Securities WT Type) and securities accounts non-exempt from Belgian withholding tax (identified with MSA Account WT Type) are put on CVAL, except if the instruction is a PFOD	Necessary: The service is necessary according to the definition	High: The control is based on the implementation of MSAs therefore the impact is high	Low: Impact of not implementing is low because the transaction will only be temporarily pending until the withholding tax is calculated by NBB-SSS		
171	Collateral Management	OeKB CSD	R-2	Settlement Instruction	CSD Validation	All receiving settlement instructions on accounts	Optional: Collateral	High: The control is based on	Medium: Impact is medium as		

Id	Business Process	CSD	Control/Restriction rule description ¹⁴¹				Impact Assessment				Additional comments
			Name	Object restriction type	Restriction processing type	Description of the control	Criterion 1 Character of the service / process	Criterion 2 Effort of implementing controls in Investor CSD's structure	Criterion 3 Risk of not implementing controls in Investor CSD's structure	Status	
					Hold	designated as "Receives blocked" (identified with MSA) will be put on CSD validation hold, unless instructed by OeKB CSD	management services are categorised as optional	the implementation of MSAs therefore the impact is high	cross-CSD transactions could be pending and require bilateral cancellation of the settlement instructions		
172	Collateral Management	OeKB CSD	R-3	Settlement Instruction	CSD Validation Hold	All delivering settlement instructions on accounts designated as "Deliveries blocked" (identified with MSA) will be put on CSD validation hold, unless instructed by OeKB CSD	Optional: Collateral management services are categorised as optional	High: The control is based on the implementation of MSAs therefore the impact is high	Medium: Impact is medium as cross-CSD transactions could be pending and require bilateral cancellation of the settlement instructions		
173	Collateral Management	OeKB CSD	R-4	Settlement Instruction	CSD Validation Hold	All settlement instructions on accounts designated as "Deliveries and Receives blocked" (identified with MSA) will be put on CSD validation hold, unless instructed by OeKB CSD	Optional: Collateral management services are categorised as optional	High: The control is based on the implementation of MSAs therefore the impact is high	Medium: Impact is medium as cross-CSD transactions could be pending and require bilateral cancellation of the settlement instructions		
174	Corporate Actions	OeKB CSD	R-1	Settlement Instruction	Rejection	<u>Specific securities positions on which an election has been made as a result of rights subscription are segregated on securities accounts that are flagged as "Technically blocked" (identified with MSA).</u> Settlement instructions on security-those accounts that are flagged as "Technically blocked" used in the context of rights subscription (identified with MSA) will be rejected, unless instructed by OeKB CSD	Necessary: The service is necessary according to the definition	High: The control is based on the implementation of MSAs therefore the impact is high	High: The impact is high as not implementing the control could result in settlement of securities that are restricted from settlement at the Issuer CSD and ownership rights not being exercised		
175	Corporate Actions	OeKB CSD	R-7	Security	Blocking	During the processing of certain Corporate Actions,	Necessary: The service is	Low: The control is solely	High: The impact is high as not		

Id	Business Process	CSD	Control/Restriction rule description ¹⁴¹				Impact Assessment				Additional comments
			Name	Object restriction type	Restriction processing type	Description of the control	Criterion 1 Character of the service / process	Criterion 2 Effort of implementing controls in Investor CSD's structure	Criterion 3 Risk of not implementing controls in Investor CSD's structure	Status	
						block all settlement instructions in the concerned ISIN, except if sent using "CORP" ISO transaction code	necessary according to the definition	based on the implementation of restriction rules and is generally needed for the activity as Issuer CSD	implementing the control could result in settlement of securities that are restricted from settlement at the Issuer CSD		
176	External Cash Settlement	OeKB CSD	RS-3 Currency	Settlement instruction	CoSD	For securities transactions involving cash settlement in currencies not eligible in T2S (i.e. non T2S settlement currencies accepted by the CSD), the securities leg is temporarily blocked in T2S until cash settlement is performed on an external settlement platform	Optional:	Not available: Investor CSDs cannot benefit from settlement services in non-T2S currencies provided by the CSD			
177	External CSD Settlement	OeKB CSD	RS-2	Settlement instruction	CoSD	For cross-CSD transactions involving a CSD external to T2S, the securities leg of the transaction is temporarily blocked until an external settlement condition has been fulfilled i.e. cash or securities settlement leg outside T2S	Optional: The service is considered optional as OeKB CSD is acting as Investor CSD of an External CSD and not as Issuer CSD, i.e. triggering the CoSD rule only in the case where the Issuer CSD is outside T2S.	Medium: The control is solely based on the implementation of a CoSD rule and is not needed for the activity as Issuer CSD	Medium: Impact is medium as cross-CSD transactions could be pending and require bilateral cancellation of the settlement instructions		
178	Insolvency Procedures	OeKB CSD	R-9	Party	Blocking	All settlement instructions on a given party are blocked upon request of the competent authority	Necessary: The service is necessary according to the definition	Low: The control is solely based on the implementation of restriction rules and is generally needed for the activity as Issuer CSD	High: Impact is high because potentially not complying with regulatory requirements depending on the scope of the suspension (in the case where the		

Id	Business Process	CSD	Control/Restriction rule description ¹⁴¹				Impact Assessment				Additional comments
			Name	Object restriction type	Restriction processing type	Description of the control	Criterion 1 Character of the service / process	Criterion 2 Effort of implementing controls in Investor CSD's structure	Criterion 3 Risk of not implementing controls in Investor CSD's structure	Status	
									participant is also participant of the Investor CSD)		
179	Insolvency Procedures	OeKB CSD	R-10	Securities Account	Blocking	All settlement instructions on a given securities account are blocked upon request of the competent authority	Necessary: The service is necessary according to the definition	Low: The control is solely based on the implementation of restriction rules and is generally needed for the activity as Issuer CSD	High: Impact is high because potentially not complying with regulatory requirements depending on the scope of the suspension (in the case where the participant is also participant of the Investor CSD)		
180	Insolvency Procedures	OeKB CSD	R-11	Securities Account	Blocking	All settlement instructions on a given securities account are blocked upon request of the competent authority, except for settlement instructions sent by OeKB CSD	Necessary: The service is necessary according to the definition	Low: The control is solely based on the implementation of restriction rules and is generally needed for the activity as Issuer CSD	High: Impact is high because potentially not complying with regulatory requirements depending on the scope of the suspension (in the case where the participant is also participant of the Investor CSD)		
181	Non-Standardised Securities	OeKB CSD	R-5	Settlement Instruction	Rejection	All settlement instructions on specific account types (identified with MSA) used in the context of securities kept in individual custody will be rejected, unless instructed with the transaction identification code "ISSU".	Optional: The service is optional according to the definition	Not available: Investor CSDs cannot benefit from DCP connection to T2S for settlement services in securities in individual custody			Investor CSDs have to instruct OeKB CSD in ICP mode in order to send settlement instructions on securities in individual custody, as additional information must be provided for the CSD to authorise the transfer. After settlement has taken

Id	Business Process	CSD	Control/Restriction rule description ¹⁴¹				Impact Assessment				Additional comments
			Name	Object restriction type	Restriction processing type	Description of the control	Criterion 1 Character of the service / process	Criterion 2 Effort of implementing controls in Investor CSD's structure	Criterion 3 Risk of <u>not</u> implementing controls in Investor CSD's structure	Status	
											place in OeKB CSD, Investor CSDs have to reflect the change in securities positions on the accounts of their participants. Based on quantitative aspects, the practical impact on Investor CSDs is expected to be very limited: there is little trading activity and very few positions overall for securities in individual custody (all ISINs and all securities accounts taken into account)
182	Operational Procedures	OeKB CSD	R-8	Security	Blocking	All settlement instructions on a given ISIN are blocked, except for OeKB CSD settlement instructions	Necessary: The process is considered necessary as operational procedures shall be defined by an Issuer CSD to ensure the management of operational risk on the settlement platform for all its participants, including Investor CSDs	Low: The control is solely based on the implementation of restriction rules and is generally needed for the activity as Issuer CSD	High: The impact is high as not implementing the control could result in settlement of securities that are restricted from settlement at the Issuer CSD		
183	Static Data Configuration	OeKB CSD	R-6	Security	Blocking	In certain cases, for instance the deactivation of a security, all settlement instructions on a given	Optional: The process is considered	Low: The control is solely based on the	High: The impact is high as not implementing the control		

Id	Business Process	CSD	Control/Restriction rule description ¹⁴¹				Impact Assessment				Additional comments
			Name	Object restriction type	Restriction processing type	Description of the control	Criterion 1 Character of the service / process	Criterion 2 Effort of implementing controls in Investor CSD's structure	Criterion 3 Risk of not implementing controls in Investor CSD's structure	Status	
						ISIN will be blocked, except if instructed by OeKB CSD	optional as it is defined by a CSD for internal static data management purposes	implementation of restriction rules and is generally needed for the activity as Issuer CSD	could result in settlement of securities that are restricted from settlement at the Issuer CSD		
184	Corporate Actions	SIX-SIS	RT03 + BL08	Settlement restriction on securities position	Rejection	Usage of specific securities positions created in the context of CA events with proxy voting is restricted, settlement restrictions sent by DCPs on these positions are rejected	Necessary: The service is necessary according to the definition	Low: The control requires segregation of securities positions but not necessarily restriction rules (privileges can be used) and is generally needed for the activity as Issuer CSD	High: The impact is high as not implementing the control could result in settlement of securities that are restricted from settlement at the Issuer CSD and ownership rights not being exercised		
185	Corporate Actions	SIX-SIS	RT03 + BL10	Settlement restriction on securities position	Rejection	Usage of specific securities positions created in the context of Mandatory Reorganisations is restricted, settlement restrictions sent by DCPs on these positions are rejected	Necessary: The service is necessary according to the definition	Low: The control can solely be based on segregation of securities positions (privileges can be used instead of restriction rules) or restriction rules and is generally needed for the activity as Issuer CSD	None: As the control can be implemented with a blocking on the ISIN level, there is no impact		
186	Corporate Actions	SIX-SIS	RT03 + BL12	Settlement restriction on securities position	Rejection	Usage of specific securities positions created in the context of Voluntary Reorganisations (elective CA) is restricted, settlement restrictions sent by DCPs on these positions are rejected	Necessary: The service is necessary according to the definition	Low: The control requires segregation of securities positions but not necessarily restriction rules (privileges can be used) and is generally needed for the activity as Issuer CSD	High: The impact is high as not implementing the control could result in settlement of securities that are restricted from settlement at the Issuer CSD and ownership rights not being exercised		
187	Corporate Actions	SIX-SIS	RT04 + BL08	Settlement Instruction on securities	Rejection	Usage of specific securities positions created in the context of CA events with	Necessary: The service is	Low: The control requires	High: The impact is high as not		

Id	Business Process	CSD	Control/Restriction rule description ¹⁴¹				Impact Assessment				Additional comments
			Name	Object restriction type	Restriction processing type	Description of the control	Criterion 1 Character of the service / process	Criterion 2 Effort of implementing controls in Investor CSD's structure	Criterion 3 Risk of <u>not</u> implementing controls in Investor CSD's structure	Status	
				position		proxy voting is restricted, settlement instructions sent by DCPs on these positions are rejected	necessary according to the definition	segregation of securities positions but not necessarily restriction rules (privileges can be used) and is generally needed for the activity as Issuer CSD	implementing the control could result in settlement of securities that are restricted from settlement at the Issuer CSD and ownership rights not being exercised		
188	Corporate Actions	SIX-SIS	RT04 + BL10	Settlement Instruction on securities position	Rejection	Usage of specific securities positions created in the context of Mandatory Reorganisations is restricted, settlement instructions sent by DCPs on these positions are rejected	Necessary: The service is necessary according to the definition	Low: The control can solely be based on segregation of securities positions (privileges can be used instead of restriction rules) or restriction rules and is generally needed for the activity as Issuer CSD	None: As the control can be implemented with a blocking on the ISIN level, there is no impact		
189	Corporate Actions	SIX-SIS	RT04 + BL12	Settlement Instruction on securities position	Rejection	Usage of specific securities positions created in the context of Voluntary Reorganisations (elective CA) is restricted, settlement instructions sent by DCPs on these positions are rejected	Necessary: The service is necessary according to the definition	Low: The control requires segregation of securities positions but not necessarily restriction rules (privileges can be used) and is generally needed for the activity as Issuer CSD	High: The impact is high as not implementing the control could result in settlement of securities that are restricted from settlement at the Issuer CSD and ownership rights not being exercised		
190	Insolvency Procedures	SIX-SIS	RT01	Settlement Instruction	Rejection	As a result of insolvency procedure, settlement instructions on a specific securities account are rejected	Necessary: The service is necessary according to the definition	High: The control is based on the implementation of MSAs therefore the impact is high	High: Impact is high because potentially not complying with regulatory requirements depending on the scope of the suspension, i.e. if it is applicable in the domestic jurisdiction of the Investor CSD (for		

Id	Business Process	CSD	Control/Restriction rule description ¹⁴¹				Impact Assessment				Additional comments
			Name	Object restriction type	Restriction processing type	Description of the control	Criterion 1 Character of the service / process	Criterion 2 Effort of implementing controls in Investor CSD's structure	Criterion 3 Risk of not implementing controls in Investor CSD's structure	Status	
									intra-CSD transactions when the suspended participant is also participant of the Investor CSD)		
191	Insolvency Procedures	SIX-SIS	RT02	Settlement Instruction	Rejection	As a result of insolvency procedure, settlement instructions on a specific ISIN are rejected	Necessary: The service is necessary according to the definition	High: The control is based on the implementation of MSAs therefore the impact is high	High: Impact is high because potentially not complying with regulatory requirements depending on the scope of the suspension, i.e. if it is applicable in the domestic jurisdiction of the Investor CSD		
192	Corporate Actions	VPLux	ISBL	Security	Blocking	During the processing of certain Corporate Actions, block all settlement instructions in the concerned ISIN, except if sent using "CORP" ISO transaction code	Necessary: The service is necessary according to the definition	Low: The control is solely based on the implementation of restriction rules and is generally needed for the activity as Issuer CSD	High: The impact is high as not implementing the control could result in settlement of securities that are restricted from settlement at the Issuer CSD		
193	Insolvency Procedures	VPLux	RHGB	Securities Account	Blocking	Settlement instructions sent on a securities account under restrictive claim (e.g. in the context of an insolvency event) are blocked for settlement, unless they relate to issuance operations ("ISSU" ISO transaction code)	Necessary: The service is necessary according to the definition	Low: The control is solely based on the implementation of restriction rules and is generally needed for the activity as Issuer CSD	High: Impact is high because potentially not complying with regulatory requirements depending on the scope of the suspension, i.e. if it is applicable in the domestic jurisdiction of the Investor CSD (for intra-CSD transactions when the suspended participant is also participant of the Investor CSD)		

Id	Business Process	CSD	Control/Restriction rule description ¹⁴¹				Impact Assessment				Additional comments
			Name	Object restriction type	Restriction processing type	Description of the control	Criterion 1 Character of the service / process	Criterion 2 Effort of implementing controls in Investor CSD's structure	Criterion 3 Risk of <u>not</u> implementing controls in Investor CSD's structure	Status	
194	Corporate Actions	VP Securities	ISBL	Security	Blocking	During the processing of certain Corporate Actions, block all settlement instructions in the concerned ISIN, except if sent using "CORP" ISO transaction code	Necessary: The service is necessary according to the definition	Low: The control is solely based on the implementation of restriction rules and is generally needed for the activity as Issuer CSD	High: The impact is high as not implementing the control could result in settlement of securities that are restricted from settlement at the Issuer CSD		
195	Insolvency Procedures	VP Securities	RHGB	Securities Account	Blocking	Settlement instructions sent on a securities account under restrictive claim (e.g. in the context of an insolvency event) are blocked for settlement, unless they relate to issuance operations or internal account transfers ("ISSU" or "OWNI" ISO transaction code)	Necessary: The service is necessary according to the definition	Low: The control is solely based on the implementation of restriction rules and is generally needed for the activity as Issuer CSD	High: Impact is high because potentially not complying with regulatory requirements depending on the scope of the suspension, i.e. if it is applicable in the domestic jurisdiction of the Investor CSD (for intra-CSD transactions when the suspended participant is also participant of the Investor CSD)		
196	Insolvency Procedures	Baltic CSDs (CSDL, ECSD, LCSD)	BCDR01 (A)	Settlement Instruction	Rejection	All settlement instructions sent by CSD participants on accounts with status "fully suspended" (identified with MSA) are rejected.	Necessary: The service is necessary according to the definition	High: The control is based on the implementation of MSAs therefore the impact is high	High: Impact of not implementing is high because potentially not complying with regulatory requirements depending on the scope of the suspension (in the case where the participant is also participant of the Investor CSD)		
197	Insolvency Procedures	Baltic CSDs (CSDL,	BCDR01 (B)	Settlement Instruction	Rejection	All settlement instructions sent by CSD participants on parties with status "fully	Necessary: The service is	High: The control is based on	High: Impact of not		

Id	Business Process	CSD	Control/Restriction rule description ¹⁴¹				Impact Assessment				Additional comments
			Name	Object restriction type	Restriction processing type	Description of the control	Criterion 1 Character of the service / process	Criterion 2 Effort of implementing controls in Investor CSD's structure	Criterion 3 Risk of not implementing controls in Investor CSD's structure	Status	
		ECSD, LCSD)				suspended" (identified with MSA) are rejected.	necessary according to the definition	the implementation of MSAs therefore the impact is high	implementing is high because potentially not complying with regulatory requirements depending on the scope of the suspension (in the case where the participant is also participant of the Investor CSD)		
198	Static Data Configuration	Baltic CSDs (CSDL, ECSD, LCSD)	BCDR02	Settlement Restriction	Rejection	All settlement restrictions sent by CSD participants are rejected with the exception of T2S generated settlement restrictions.	Optional: The process is considered optional as it is defined by a CSD for internal static data management purposes	Not available: Segregation of securities positions by blocking and reservation restriction types is not available to participants of the Baltic CSDs including Investor CSDs.			
199	Insolvency Procedures	Baltic CSDs (CSDL, ECSD, LCSD)	BCDR03 (A)	Settlement Instruction	Rejection	All delivering settlement instructions sent by CSD participants on accounts with status "delivery suspended" or "blocked" (identified with MSA configured as "Debit") are rejected.	Necessary: The service is necessary according to the definition	High: The control is based on the implementation of MSAs therefore the impact is high	High: Impact of not implementing is high because potentially not complying with regulatory requirements depending on the scope of the suspension (in the case where the participant is also participant of the Investor CSD)		
200	Insolvency Procedures	Baltic CSDs (CSDL, ECSD, LCSD)	BCDR03 (B)	Settlement Instruction	Rejection	All delivering settlement instructions sent by CSD participants on parties with status "delivery suspended" (identified with MSA configured as "Debit") are rejected.	Necessary: The service is necessary according to the definition	High: The control is based on the implementation of MSAs therefore the impact is high	High: Impact of not implementing is high because potentially not complying with regulatory requirements depending on the scope of the suspension (in the		

Id	Business Process	CSD	Control/Restriction rule description ¹⁴¹				Impact Assessment				Additional comments
			Name	Object restriction type	Restriction processing type	Description of the control	Criterion 1 Character of the service / process	Criterion 2 Effort of implementing controls in Investor CSD's structure	Criterion 3 Risk of not implementing controls in Investor CSD's structure	Status	
									case where the participant is also participant of the Investor CSD)		
201	Insolvency Procedures	Baltic CSDs (CSDL, ECSD, LCSD)	BCDR04 (A)	Settlement Instruction	Rejection	All receiving settlement instructions sent by CSD participants on accounts with status "receive suspended" (identified with MSA configured as "Credit") are rejected.	Necessary: The service is necessary according to the definition	High: The control is based on the implementation of MSAs therefore the impact is high	High: Impact of not implementing is high because potentially not complying with regulatory requirements depending on the scope of the suspension (in the case where the participant is also participant of the Investor CSD)		
202	Insolvency Procedures	Baltic CSDs (CSDL, ECSD, LCSD)	BCDR04 (B)	Settlement Instruction	Rejection	All receiving settlement instructions sent by CSD participants on parties with status "receive suspended" (identified with MSA configured as "Credit") are rejected.	Necessary: The service is necessary according to the definition	High: The control is based on the implementation of MSAs therefore the impact is high	High: Impact of not implementing is high because potentially not complying with regulatory requirements depending on the scope of the suspension (in the case where the participant is also participant of the Investor CSD)		
203	Other Regulatory Compliance	Baltic CSDs (CSDL, ECSD, LCSD)	BCDR05 +STOP	Settlement Instruction on securities position	Rejection	Upon enforcement of a Court Order, specific securities positions may be restricted, settlement instructions sent by CSD participants on these positions are rejected	Necessary: The service is necessary according to the definition	Low: The control requires segregation of securities positions but not necessarily restriction rules (privileges can be used) and is generally needed for the activity as Issuer CSD	High: Impact is high because potentially not complying with regulatory requirements depending on the scope of the suspension, i.e. if it is applicable in the jurisdiction of the Investor CSD.		

Id	Business Process	CSD	Control/Restriction rule description ¹⁴¹				Impact Assessment				Additional comments
			Name	Object restriction type	Restriction processing type	Description of the control	Criterion 1 Character of the service / process	Criterion 2 Effort of implementing controls in Investor CSD's structure	Criterion 3 Risk of not implementing controls in Investor CSD's structure	Status	
204	Collateral Management	Baltic CSDs (CSDL, ECSD, LCSD)	BCDR05 +PLDG	Settlement Instruction on securities position	Rejection	Settlement instructions sent by CSD participants on specific securities positions created in the context of bilateral pledge operations (blocked for pledge) are rejected.	Optional: Collateral management services are categorised as optional	Low: The control requires segregation of securities positions but not necessarily restriction rules (privileges can be used) and is needed for the activity as Issuer CSD	High: The impact is high as not implementing the control (i.e. segregation of eligible collateral) could result in settlement of securities that are restricted from settlement at the Issuer CSD.		Segregation in specific securities position is only done upon request of the Investor CSD. It is therefore assumed that this segregation is required as Issuer CSD.
205	Corporate Actions	Baltic CSDs (CSDL, ECSD, LCSD)	BCDR05 +CABL	Settlement Instruction on securities position	Rejection	Settlement instructions sent by CSD participants on specific securities positions created in the context of elective CA (blocked for CA) are rejected.	Necessary: The service is necessary according to the definition	Low: The control requires segregation of securities positions but not necessarily restriction rules (privileges can be used) and is generally needed for the activity as Issuer CSD	High: The impact is high as not implementing the control could result in settlement of securities that are restricted from settlement at the Issuer CSD and ownership rights not being exercised.		
206	Investment Funds Processing	Baltic CSDs (CSDL, ECSD, LCSD)	BCDR06 + BCDR07	Settlement Instruction	Rejection	All settlement instructions sent by CSD participants on accounts with status "issuance account" (identified with MSA) are rejected unless instructed by an authorised fund administrator on a specific "issuance account" and ISIN.	Optional: Services related to Investment Funds Processing are considered optional	High: The control is based on the implementation of MSAs therefore the impact is high	None: The impact of not implementing the control is none since the securities accounts subject to rejection are not held by Investor CSDs.		
207	Other Regulatory Compliance	Baltic CSDs (ECSD)	ECDR11	Settlement Instruction	Rejection	All receiving settlement instructions sent by CSD participants to transfer ISINs with status "non-pledgeable" (identified with MSA) into accounts with status "pledge account" (identified with MSA configured as "Credit") are	Necessary: The service is necessary according to the definition	High: The control is based on the implementation of MSAs therefore the impact is high	High: Impact is high because potentially not complying with regulatory requirements if these are also applicable in the jurisdiction of the		Although the process of pledging would be categorised as collateral management, the origin of the control is a regulatory requirement, i.e. this restriction rule is set

Id	Business Process	CSD	Control/Restriction rule description ¹⁴¹				Impact Assessment				Additional comments
			Name	Object restriction type	Restriction processing type	Description of the control	Criterion 1 Character of the service / process	Criterion 2 Effort of implementing controls in Investor CSD's structure	Criterion 3 Risk of <u>not</u> implementing controls in Investor CSD's structure	Status	
						rejected.			Investor CSD.		up in the context of non-listed "Private Limited Companies", as recognised in the Estonian Law.
208	Other Regulatory Compliance	Baltic CSDs (ECSD)	ECDR12	Settlement Instruction	Rejection	All receiving settlement instructions sent by CSD participants to transfer ISINs with status "decision required" (identified with MSA) into accounts with status "pledge account" (identified with MSA configured as "Credit") are rejected.	Necessary: The service is necessary according to the definition	High: The control is based on the implementation of MSAs therefore the impact is high	High: Impact is high because potentially not complying with regulatory requirements if these are also applicable in the jurisdiction of the Investor CSD.		Although the process of pledging would be categorised as collateral management, the origin of the control is a regulatory requirement, i.e. this restriction rule is set up in the context of non-listed "Private Limited Companies", as recognised in the Estonian Law.
209	Other Regulatory Compliance	Baltic CSDs (CSDL, ECSD)	BCDR13	Settlement Instruction	Rejection	All receiving settlement instructions to transfer ISINs with status "restricted" (identified with MSA) into omnibus accounts of Investor CSDs are rejected.	Necessary: The service is necessary according to the definition	High: The control is based on the implementation of MSAs therefore the impact is high	High: Impact is high because potentially not complying with regulatory requirements if these are also applicable in the jurisdiction of the Investor CSD.		This restriction rule is set up in the context of non-listed "Private Limited Companies" where there is a pre-emptive right of existing shareholders on the security or the securities are not freely pledgeable. Due to legal requirements or market practices, many non-listed private companies are registered in the Estonian or Lithuanian CSD.

Id	Business Process	CSD	Control/Restriction rule description ¹⁴¹				Impact Assessment				Additional comments	
			Name	Object restriction type	Restriction processing type	Description of the control	Criterion 1 Character of the service / process	Criterion 2 Effort of implementing controls in Investor CSD's structure	Criterion 3 Risk of <u>not</u> implementing controls in Investor CSD's structure	Status		
												The restriction will not be put in place for Investor CSDs who agree to put an MSA in place in their SSS to alert that settlement of the security is subject to special conditions. 75% of securities registered in the Estonian CSD are either having a pre-emptive right or are not freely pledgeable (i.e. 75% of instruments will have MSA value "restricted"). However, the transaction volumes with those securities are not high, about 3% of all transactions are made with those "restricted" securities.
210	Insolvency Procedures	Baltic CSDs (CSDL, ECSD, LCSD)	BCDR 14 (C)	Securities	Blocking	All settlement instructions on a given ISIN are blocked upon request of the competent authority, except for settlement instructions sent by Baltic CSDs using the ISO transaction codes "CORP", "ISSU", or "REDM".	Necessary: The service is necessary according to the definition	Low: The control is solely based on the implementation of restriction rules and is generally needed for the activity as Issuer CSD	High: Impact is high because potentially not complying with regulatory requirements depending on the scope of the suspension, i.e. if it is applicable in the domestic jurisdiction of the Investor CSD			
211	Insolvency Procedures	Baltic CSDs	BCDR 14 (A)	Securities account	Blocking	All settlement instructions on a given securities	Necessary:	Low:	High:			

Id	Business Process	CSD	Control/Restriction rule description ¹⁴¹				Impact Assessment				Additional comments
			Name	Object restriction type	Restriction processing type	Description of the control	Criterion 1 Character of the service / process	Criterion 2 Effort of implementing controls in Investor CSD's structure	Criterion 3 Risk of not implementing controls in Investor CSD's structure	Status	
		(CSDL, ECSD, LCSD)				account are blocked upon request of the competent authority, except for settlement instructions sent by Baltic CSDs using the ISO transaction codes "CORP", "ISSU", or "REDM".	The service is necessary according to the definition	The control is solely based on the implementation of restriction rules and is generally needed for the activity as Issuer CSD	Impact is high because potentially not complying with regulatory requirements depending on the scope of the suspension, i.e. if it is applicable in the domestic jurisdiction of the Investor CSD		
212	Insolvency Procedures	Baltic CSDs (CSDL, ECSD, LCSD)	BCDR 14 (B)	Party	Blocking	All settlement instructions on a given party are blocked upon request of the competent authority, except for settlement instructions sent by Baltic CSDs using the ISO transaction codes "CORP", "ISSU", or "REDM".	Necessary: The service is necessary according to the definition	Low: The control is solely based on the implementation of restriction rules and is generally needed for the activity as Issuer CSD	High: Impact is high because potentially not complying with regulatory requirements depending on the scope of the suspension, i.e. if it is applicable in the domestic jurisdiction of the Investor CSD		
213	Operational Procedures	Baltic CSDs (CSDL, ECSD, LCSD)	BCDR 15	Security	Blocking	All settlement instructions on a given ISIN are blocked, except for settlement instructions sent by Baltic CSDs.	Necessary: The process is considered necessary as operational procedures shall be defined by an Issuer CSD to ensure the management of operational risk on the settlement platform for all its participants, including Investor CSDs	Low: The control is solely based on the implementation of restriction rules and is generally needed for the activity as Issuer CSD	High: The impact is high as not implementing the control could result in settlement of securities that are restricted from settlement at the Issuer CSD		
214	Insolvency Procedures	Baltic CSDs (CSDL, ECSD,	BCDR 16 (A)	Securities account	Blocking	All delivering settlement instructions on a given securities account are blocked upon request of the	Necessary: The service is necessary	Low: The control is solely based on the	High: Impact is high because potentially not		

Id	Business Process	CSD	Control/Restriction rule description ¹⁴¹				Impact Assessment				Additional comments
			Name	Object restriction type	Restriction processing type	Description of the control	Criterion 1 Character of the service / process	Criterion 2 Effort of implementing controls in Investor CSD's structure	Criterion 3 Risk of not implementing controls in Investor CSD's structure	Status	
		LCSD)				competent authority, except for settlement instructions sent by Baltic CSDs using the ISO transaction codes "CORP", "ISSU", or "REDM".	according to the definition	implementation of restriction rules and is generally needed for the activity as Issuer CSD	complying with regulatory requirements depending on the scope of the suspension, i.e. if it is applicable in the domestic jurisdiction of the Investor CSD		
215	Insolvency Procedures	Baltic CSDs (CSDL, ECSD, LCSD)	BCDR 16 (B)	Party	Blocking	All delivering settlement instructions on a given party are blocked upon request of the competent authority, except for settlement instructions sent by Baltic CSDs using the ISO transaction codes "CORP", "ISSU", or "REDM".	Necessary: The service is necessary according to the definition	Low: The control is solely based on the implementation of restriction rules and is generally needed for the activity as Issuer CSD	High: Impact is high because potentially not complying with regulatory requirements depending on the scope of the suspension, i.e. if it is applicable in the domestic jurisdiction of the Investor CSD		
216	Insolvency Procedures	Baltic CSDs (CSDL, ECSD, LCSD)	BCDR 17 (A)	Securities account	Blocking	All receiving settlement instructions on a given securities account are blocked upon request of the competent authority, except for settlement instructions sent by Baltic CSDs using the ISO transaction codes "CORP", "ISSU", or "REDM".	Necessary: The service is necessary according to the definition	Low: The control is solely based on the implementation of restriction rules and is generally needed for the activity as Issuer CSD	High: Impact is high because potentially not complying with regulatory requirements depending on the scope of the suspension, i.e. if it is applicable in the domestic jurisdiction of the Investor CSD		
217	Insolvency Procedures	Baltic CSDs (CSDL, ECSD, LCSD)	BCDR 17 (B)	Party	Blocking	All receiving settlement instructions on a given party are blocked upon request of the competent authority, except for settlement instructions sent by Baltic CSDs using the ISO transaction codes "CORP", "ISSU", or "REDM".	Necessary: The service is necessary according to the definition	Low: The control is solely based on the implementation of restriction rules and is generally needed for the activity as Issuer CSD	High: Impact is high because potentially not complying with regulatory requirements depending on the scope of the suspension, i.e. if it is applicable in the domestic jurisdiction of the Investor CSD		

Id	Business Process	CSD	Control/Restriction rule description ¹⁴¹				Impact Assessment				Additional comments
			Name	Object restriction type	Restriction processing type	Description of the control	Criterion 1 Character of the service / process	Criterion 2 Effort of implementing controls in Investor CSD's structure	Criterion 3 Risk of not implementing controls in Investor CSD's structure	Status	
218	Static Data Configuration	Baltic CSDs (CSDL, ECSD, LCSD)	EARM (optional)	Securities position	Earmarking	Securities are earmarked in a specific position at the request of the participant. This segregation is planned for generic settlement management	Optional: The process is considered optional as it is defined by a CSD for internal static data management purposes	Low: The control requires segregation of securities positions and is needed for the activity as Issuer CSD	High: The impact is high as not implementing the control could result in settlement of securities that are restricted from settlement at the Issuer CSD		Segregation in specific securities position is only done upon request of the Investor CSD. It is therefore assumed that this segregation is required as Issuer CSD
219	External Cash Settlement	Baltic CSDs (LCSD)	LCSD_C oSD	Settlement instruction	CoSD	For securities transactions involving cash settlement in currencies not eligible in T2S (i.e. non T2S settlement currencies accepted by the CSD), the securities delivery leg is temporarily blocked in T2S until cash settlement is performed on an external settlement platform	Optional: Cash settlement services in non T2S currencies are considered optional	Not available: Investor CSDs cannot benefit from settlement services in non-T2S currencies provided by the CSD			
220	Static Data Configuration	Iberclear	AS01/ AS02/ AS03	Securities position	Earmarking	Securities are earmarked in a specific position at the request of the participant. This segregation is not planned for a specific process.	Optional: The process is considered optional as it is defined by a CSD for internal static data management purposes.	Low: The control requires segregation of securities positions and is needed for the activity as Issuer CSD.	High: The impact is high as not implementing the control could result in settlement of securities that are restricted from settlement at the Issuer CSD.		Segregation in specific securities position is only done upon request of the Investor CSD. It is therefore assumed that this segregation is required as Issuer CSD.
221	Corporate Actions	Iberclear	ECO1	Securities position	Earmarking	Securities are earmarked in a specific position at the request of the participant. This segregation is planned for elective corporate actions events.	Necessary: The service is necessary according to the definition.	Low: The control requires segregation of securities positions and is needed for the activity as Issuer CSD.	High: The impact is high as not implementing the control could result in settlement of securities that are restricted from settlement at the Issuer CSD and ownership rights not being exercised.		Segregation in specific securities position is only done upon request of the Investor CSD. It is therefore assumed that this segregation is required as Issuer CSD. This is a temporary

Id	Business Process	CSD	Control/Restriction rule description ¹⁴¹				Impact Assessment				Additional comments
			Name	Object restriction type	Restriction processing type	Description of the control	Criterion 1 Character of the service / process	Criterion 2 Effort of implementing controls in Investor CSD's structure	Criterion 3 Risk of <u>not</u> implementing controls in Investor CSD's structure	Status	
											segregation facilitating the management of the elective CA for Iberclear participants before the "Market Deadline" of the event. Alternatively, the participant can directly transmit a CA instruction for Iberclear to move securities to the restricted positions EC11/EC12.
222	Corporate Actions	Iberclear	ECO2	Securities position	Earmarking	Securities are earmarked in a specific position at the request of the participant. This segregation is planned for elective corporate actions events.	Necessary: The service is necessary according to the definition.	Low: The control requires segregation of securities positions and is needed for the activity as Issuer CSD.	High: The impact is high as not implementing the control could result in settlement of securities that are restricted from settlement at the Issuer CSD and ownership rights not being exercised.		Segregation in specific securities position is only done upon request of the Investor CSD. It is therefore assumed that this segregation is required as Issuer CSD. This is a temporary segregation facilitating the management of the elective CA for Iberclear participants before the "Market Deadline" of the event. Alternatively, the participant can directly transmit a CA instruction for Iberclear to move securities to the restricted positions EC11/EC12.

Id	Business Process	CSD	Control/Restriction rule description ¹⁴¹				Impact Assessment				Additional comments
			Name	Object restriction type	Restriction processing type	Description of the control	Criterion 1 Character of the service / process	Criterion 2 Effort of implementing controls in Investor CSD's structure	Criterion 3 Risk of not implementing controls in Investor CSD's structure	Status	
223	Corporate Actions	Iberclear	IBR1 + RSP1 + ECI1	Settlement Instruction on securities position	Rejection	The usage of securities positions earmarked for mandatory and elective corporate actions events is restricted. Settlement instructions sent by the CSD participants on these specific positions are rejected.	Necessary: The service is necessary according to the definition.	Low: The control requires segregation of securities positions but not necessarily restriction rules (privileges can be used) and is generally needed for the activity as Issuer CSD.	High: The impact is high as not implementing the control could result in settlement of securities that are restricted from settlement at the Issuer CSD and ownership rights not being exercised.		
224	Corporate Actions	Iberclear	IBR1 + RSP1 + ECI2	Settlement Instruction on securities position	Rejection	The usage of securities positions earmarked for mandatory and elective corporate actions events is restricted. Settlement instructions sent by the CSD participants on these specific positions are rejected.	Necessary: The service is necessary according to the definition.	Low: The control requires segregation of securities positions but not necessarily restriction rules (privileges can be used) and is generally needed for the activity as Issuer CSD.	High: The impact is high as not implementing the control could result in settlement of securities that are restricted from settlement at the Issuer CSD and ownership rights not being exercised.		
225	Corporate Actions	Iberclear	IBR2 + RSP2 + ECI1	Settlement Restriction on securities position	Rejection	The usage of securities positions earmarked for mandatory and elective corporate actions events is restricted. Settlement restrictions sent by the CSD participants on these specific positions are rejected.	Necessary: The service is necessary according to the definition.	Low: The control requires segregation of securities positions but not necessarily restriction rules (privileges can be used) and is generally needed for the activity as Issuer CSD.	High: The impact is high as not implementing the control could result in settlement of securities that are restricted from settlement at the Issuer CSD and ownership rights not being exercised.		
226	Corporate Actions	Iberclear	IBR2 + RSP2 + ECI2	Settlement Restriction on securities position	Rejection	The usage of securities positions earmarked for mandatory and elective corporate actions events is restricted. Settlement restrictions sent by the CSD participants on these specific positions are	Necessary: The service is necessary according to the definition.	Low: The control requires segregation of securities positions but not necessarily restriction rules (privileges can be used) and is generally	High: The impact is high as not implementing the control could result in settlement of securities that are restricted from settlement at the Issuer		

Id	Business Process	CSD	Control/Restriction rule description ¹⁴¹				Impact Assessment				Additional comments
			Name	Object restriction type	Restriction processing type	Description of the control	Criterion 1 Character of the service / process	Criterion 2 Effort of implementing controls in Investor CSD's structure	Criterion 3 Risk of not implementing controls in Investor CSD's structure	Status	
						rejected.		needed for the activity as Issuer CSD.	CSD and ownership rights not being exercised.		
227	Operational Procedures	Iberclear	IBR1	Settlement Instruction	Rejection	Settlement instructions sent to T2S by Iberclear will be used to bypass (negative rule) other restriction rules (rejection).	Necessary: The process is considered necessary as operational procedures shall be defined by an Issuer CSD to ensure the management of operational risk on the settlement platform for all its participants, including Investor CSDs.	Low: The control is solely based on the implementation of restriction rules and could be required as Issuer CSD, therefore the impact is low.	None: No impact since this restriction is used by the CSD to bypass other restriction rules.		
228	Operational Procedures	Iberclear	IBR2	Settlement Restriction	Rejection	Settlement restrictions sent to T2S by Iberclear will be used to bypass (negative rule) other restriction rules (rejection).	Necessary: The process is considered necessary as operational procedures shall be defined by an Issuer CSD to ensure the management of operational risk on the settlement platform for all its participants, including Investor CSDs.	Low: The control is solely based on the implementation of restriction rules and could be required as Issuer CSD, therefore the impact is low.	None: No impact since this restriction is used by the CSD to bypass other restriction rules.		
229	Operational Procedures	Iberclear	BIS1	Security	Blocking	All settlement instructions on a given ISIN are blocked, except for settlement instructions sent	Necessary: The process is considered	Low: The control is solely based on the	High: The impact is high as not implementing the control		

Id	Business Process	CSD	Control/Restriction rule description ¹⁴¹				Impact Assessment				Additional comments
			Name	Object restriction type	Restriction processing type	Description of the control	Criterion 1 Character of the service / process	Criterion 2 Effort of implementing controls in Investor CSD's structure	Criterion 3 Risk of not implementing controls in Investor CSD's structure	Status	
						by Iberclear.	necessary as operational procedures shall be defined by an Issuer CSD to ensure the management of operational risk on the settlement platform for all its participants, including Investor CSDs.	implementation of restriction rules and is generally needed for the activity as Issuer CSD.	could result in settlement of securities that are restricted from settlement at the Issuer CSD.		
230	Corporate Actions	Iberclear	BLEC	Security	Blocking	During the processing of certain Corporate Actions, block all settlement instructions in the concerned ISIN, except if sent using "CORP" ISO transaction code.	Necessary: The service is necessary according to the definition.	Low: The control is solely based on the implementation of restriction rules and is generally needed for the activity as Issuer CSD.	High: The impact is high as not implementing the control could result in settlement of securities that are restricted from settlement at the Issuer CSD.		
231	Operational Procedures	Iberclear	BSA1	Securities account	Blocking	All settlement instructions on a given security account are blocked, except for settlement instructions sent by Iberclear.	Necessary: The process is considered necessary as operational procedures shall be defined by an Issuer CSD to ensure the management of operational risk on the settlement platform for all its participants, including Investor CSDs.	Low: The control is solely based on the implementation of restriction rules and is generally needed for the activity as Issuer CSD.	High: Impact is high because potentially not complying with regulatory requirements depending on the scope of the suspension (in the case where the participant is also participant of the Investor CSD).		
232	Operational Procedures	Iberclear	BPA1	Party	Blocking	All settlement instructions on a given party are	Necessary:	Low:	High:		

Id	Business Process	CSD	Control/Restriction rule description ¹⁴¹				Impact Assessment				Additional comments
			Name	Object restriction type	Restriction processing type	Description of the control	Criterion 1 Character of the service / process	Criterion 2 Effort of implementing controls in Investor CSD's structure	Criterion 3 Risk of <u>not</u> implementing controls in Investor CSD's structure	Status	
						blocked, except for settlement instructions sent by Iberclear..	The process is considered necessary as operational procedures shall be defined by an Issuer CSD to ensure the management of operational risk on the settlement platform for all its participants, including Investor CSDs.	The control is solely based on the implementation of restriction rules and is generally needed for the activity as Issuer CSD.	Impact is high because potentially not complying with regulatory requirements depending on the scope of the suspension (in the case where the participant is also participant of the Investor CSD).		
233	External CSD Settlement	Iberclear	RSP1 + IBR1 + BL01	Settlement Instruction on securities position	Rejection	The usage of securities positions blocked for external CSD settlement (Argentina and Brazil) is restricted. Settlement instructions sent by the CSD participants on these specific positions are rejected.	Optional: The service is considered optional as Iberclear is triggering the restriction rule when acting as Technical Issuer CSD of Argentinian and Brazilian depositories.	Not available: Investor CSDs cannot benefit from the service provided by Iberclear in specific business scenarios (delivery to an Investor CSD participant to a participant of the Brazilian or Argentinian depository).			Investor CSDs have to instruct Iberclear in ICP mode in some business scenarios in order to settle Brazilian or Argentinian securities. The impact on Investor CSDs is deemed very limited based on quantitative aspects. Indeed, Iberclear is only servicing 4 securities via two external CSD links, with Argentina and Brazil, and the volume of transactions on those links is very low. In addition, according to Iberclear, none of Iberclear's Investor CSDs expressed an

Id	Business Process	CSD	Control/Restriction rule description ¹⁴¹				Impact Assessment				Additional comments
			Name	Object restriction type	Restriction processing type	Description of the control	Criterion 1 Character of the service / process	Criterion 2 Effort of implementing controls in Investor CSD's structure	Criterion 3 Risk of <u>not</u> implementing controls in Investor CSD's structure	Status	
											interest in servicing those securities.
234	External CSD Settlement	Iberclear	RSP2 + IBR2 + BL01	Settlement Restriction on securities position	Rejection	The usage of securities positions blocked for external CSD settlement is restricted. Settlement restrictions sent by the CSD participants on these specific positions are rejected.	Optional: The service is considered optional as Iberclear is triggering the restriction rule when acting as Technical Issuer CSD of Argentinian and Brazilian depositories.	Not available: Investor CSDs cannot benefit from the service provided by Iberclear			
235	Operational Procedures	Iberclear	BIS3	Security	Blocking	During critical changes (MSU, SUM, ST, DSU, etc), all settlement instructions on the concerned ISIN are blocked, except for auto-collateralisation and realignment settlement instructions (i.e. settlement instruction with ISO transaction code "AUTO" or "REAL").	Necessary: The process is considered necessary as operational procedures shall be defined by an Issuer CSD to ensure the management of operational risk on the settlement platform for all its participants, including Investor CSDs.	Low: The control is solely based on the implementation of restriction rules and could be required as Issuer CSD, therefore the impact is low.	High: The impact is high as not implementing the control could result in settlement of securities that are restricted from settlement at the Issuer CSD.		This restriction may still be required for residual cases after implementation of CR 538.
236	Taxation	Iberclear	RITO	Settlement Instruction	Rejection	All settlement instructions on a specific Italian ISIN (identified with MSA) on a third party Iberclear security account (identified with MSA) are rejected.	Not assessed:	Not assessed:	Not assessed:		Controls defined as Investor CSD of a CSD in T2S are not assessed.

Id	Business Process	CSD	Control/Restriction rule description ¹⁴¹				Impact Assessment				Additional comments
			Name	Object restriction type	Restriction processing type	Description of the control	Criterion 1 Character of the service / process	Criterion 2 Effort of implementing controls in Investor CSD's structure	Criterion 3 Risk of <u>not</u> implementing controls in Investor CSD's structure	Status	
237	Foreign Securities	Iberclear	RNVD + RPVD + IBR1 + New rule	Settlement Instruction	Rejection	Settlement instructions in securities issued by Iberclear in a foreign currency [DKK, USD, CHF, GBP, MXN, and JPY - identified with MSA] are rejected, unless they are realignment instructions or sent by Iberclear, or an authorised party BIC.	Necessary: The service is considered necessary since the CSD defining the rules is acting as Issuer CSD.	High: The control is based on the implementation of MSAs therefore the impact is high	High: The impact is high as not implementing the control could result in settlement of securities that are restricted from settlement at the Issuer CSD.		Before accepting a participant to settle instructions in foreign securities, it is needed to have the confirmation that the participant has opened an account at a correspondent bank in that currency. Settlement is in EUR, but the payment of CA proceeds is performed in the denomination currency of the security.
238	Static Data Configuration	Iberclear	RNOI + RPOI + IBR1	Settlement Instruction	Rejection	Settlement instructions sent on specific securities accounts (identified with MSA) used for operations managed exclusively in ICP mode (such as collateral and pledging) are rejected, unless they are instructed by Iberclear, or are T2S generated realignment or auto-collateralisation instructions.	Optional: The process is considered optional as it is defined by a CSD for internal static data management purposes	High: The control is based on the implementation of MSAs therefore the impact is high.	None: Impact of not implementing is none because Investor CSDs' settlement flows are not impacted		
239	Insolvency Procedures	Euroclear Finland	PSUS (A)	Settlement Instruction	Rejection (Positive)	Settlement instructions on parties with status "Suspended" (identified with MSA – "BPSTATUS") are rejected.	Necessary: The service is necessary according to the definition.	High: The control is based on the implementation of MSAs therefore the impact is high.	High: Impact is high because potentially not complying with regulatory requirements depending on the scope of the suspension, i.e. if		

Id	Business Process	CSD	Control/Restriction rule description ¹⁴¹				Impact Assessment				Additional comments
			Name	Object restriction type	Restriction processing type	Description of the control	Criterion 1 Character of the service / process	Criterion 2 Effort of implementing controls in Investor CSD's structure	Criterion 3 Risk of not implementing controls in Investor CSD's structure	Status	
									it is applicable in the domestic jurisdiction of the Investor CSD (for intra-CSD transactions when the suspended participant is also participant of the Investor CSD).		
240	Static Data Configuration	Euroclear Finland	PSUS (B)	Settlement Instruction	Rejection (Positive)	Settlement instructions on parties with status "To Be Deleted" (identified with MSA – "BPSTATUS") are rejected.	Optional: The process is considered optional as it is defined by a CSD for internal static data management purposes.	High: The control is based on the implementation of MSAs therefore the impact is high.	None: No impact since this restriction is used by the CSD to manage the deletion of a party. Only after all validations are successfully processed, the party can be deleted. This internal process does not have an impact on Investor CSDs.		
241	Operational Procedures	Euroclear Finland	EXCA	Settlement Instruction	Rejection (Negative)	Settlement instructions sent to T2S by Euroclear Finland with the "CORP" ISO transaction code will be used to bypass (negative rule) other restriction rules (rejection).	Necessary: The process is considered necessary as operational procedures shall be defined by an Issuer CSD to ensure the management of operational risk on the settlement platform for all its participants, including Investor CSDs.	Low: The control is solely based on the implementation of restriction rules and could be required as Issuer CSD, therefore the impact is low.	None: No impact since this restriction is used by the CSD to bypass other restriction rules.		

Id	Business Process	CSD	Control/Restriction rule description ¹⁴¹				Impact Assessment				Additional comments
			Name	Object restriction type	Restriction processing type	Description of the control	Criterion 1 Character of the service / process	Criterion 2 Effort of implementing controls in Investor CSD's structure	Criterion 3 Risk of <u>not</u> implementing controls in Investor CSD's structure	Status	
242	Static Data Configuration	Euroclear Finland	RESP + RESN	Settlement Restriction	Rejection (Positive/Negative)	All settlement restrictions sent by CSD Participants or External CSDs are rejected with the exception of T2S generated settlement restrictions for Conditional Securities Delivery (COSP).	Optional: The process is considered optional as it is defined by a CSD for internal static data management purposes.	Not available: Segregation of securities positions by blocking and reservation restriction types is not available to participants of Euroclear Finland, including Investor CSDs.			
243	Other Regulatory Compliance	Euroclear Finland	ASTS (A)	Settlement Instruction	Rejection (Positive)	All delivering settlement instructions on accounts with status "Suspended" (identified with MSA configured as "Debit" – "ACCOUNTSTATUS") are rejected.	Necessary: The service is necessary according to the definition.	High: The control is based on the implementation of MSAs therefore the impact is high.	High: Impact is high because potentially not complying with regulatory requirements depending on the scope of the suspension, i.e. if it is applicable in the domestic jurisdiction of the Investor CSD (for intra-CSD transactions when the suspended participant is also participant of the Investor CSD).		
244	Other Regulatory Compliance	Euroclear Finland	ASTS (B)	Settlement Instruction	Rejection (Positive)	Settlement instructions on accounts with status "Frozen" (identified with MSA – "ACCOUNTSTATUS") are rejected.	Necessary: The service is necessary according to the definition.	High: The control is based on the implementation of MSAs therefore the impact is high.	High: Impact is high because potentially not complying with regulatory requirements depending on the scope of the suspension, i.e. if it is applicable in the domestic jurisdiction of the Investor CSD (for intra-CSD transactions		

Id	Business Process	CSD	Control/Restriction rule description ¹⁴¹				Impact Assessment				Additional comments
			Name	Object restriction type	Restriction processing type	Description of the control	Criterion 1 Character of the service / process	Criterion 2 Effort of implementing controls in Investor CSD's structure	Criterion 3 Risk of not implementing controls in Investor CSD's structure	Status	
									when the suspended participant is also participant of the Investor CSD).		
245	Static Data Configuration	Euroclear Finland	ASTS (C)	Settlement Instruction	Rejection (Positive)	Settlement instructions on accounts with status "To be Deleted" (identified with MSA – "ACCOUNTSTATUS") are rejected.	Optional: The process is considered optional as it is defined by a CSD for internal static data management purposes.	High: The control is based on the implementation of MSAs therefore the impact is high.	None: No impact since this restriction is used by the CSD to manage the deletion of an account. Only after all validations are successfully processed, the account can be deleted. This internal process does not have an impact on Investor CSDs.		
246	Other Regulatory Compliance	Euroclear Finland	ACDR	Securities Account	Blocking (Positive /Negative)	Settlement instructions debiting a specific securities account are blocked, unless sent to T2S with the "CORP" ISO transaction code, or debiting the "COSP" or "EEUR" securities positions used by T2S for respectively Conditional Securities Delivery and auto-collateralisation.	Necessary: The service is necessary according to the definition.	Low: The control is solely based on the implementation of restriction rules and is generally needed for the activity as Issuer CSD.	High: Impact is high because potentially not complying with regulatory requirements depending on the scope of the suspension, i.e. if it is applicable in the domestic jurisdiction of the Investor CSD (for intra-CSD transactions when the suspended participant is also participant of the Investor CSD).		
247	Other Regulatory Compliance	Euroclear Finland	ACCR	Securities Account	Blocking (Positive /Negative)	Settlement instructions on a specific securities account are blocked, unless sent to	Necessary: The service is	Low: The control is solely	High: Impact is high because		

Id	Business Process	CSD	Control/Restriction rule description ¹⁴¹				Impact Assessment				Additional comments
			Name	Object restriction type	Restriction processing type	Description of the control	Criterion 1 Character of the service / process	Criterion 2 Effort of implementing controls in Investor CSD's structure	Criterion 3 Risk of not implementing controls in Investor CSD's structure	Status	
						T2S with the "CORP" ISO transaction code or debiting/crediting the "COSP" or "EEUR" securities positions used by T2S for respectively Conditional Securities Delivery and auto-collateralisation.	necessary according to the definition.	based on the implementation of restriction rules and is generally needed for the activity as Issuer CSD.	potentially not complying with regulatory requirements depending on the scope of the suspension, i.e. if it is applicable in the domestic jurisdiction of the Investor CSD (for intra-CSD transactions when the suspended participant is also participant of the Investor CSD).		
248	Other Regulatory Compliance	Euroclear Finland	ISUS	Settlement Instruction	Rejection (Positive)	Settlement instructions on an ISIN with status "Suspended" or "To be Deleted" (identified with MSA – "INSTRUMENT STATUS") are rejected.	Necessary: The service is necessary according to the definition.	High: The control is based on the implementation of MSAs therefore the impact is high.	High: Impact is high because potentially not complying with regulatory requirements if the restriction is not applied.		
249	Other Regulatory Compliance	Euroclear Finland	ISEV	Settlement Instruction	Rejection (Positive)	Settlement instructions on accounts with status "Y" (identified with MSA – "PARTYHOLD") are rejected.	Necessary: The service is necessary according to the definition.	High: The control is based on the implementation of MSAs therefore the impact is high.	High: Impact is high because potentially not complying with regulatory requirements depending on the scope of the suspension, i.e. if it is applicable in the domestic jurisdiction of the Investor CSD (for intra-CSD transactions when the suspended participant is also participant of the Investor CSD).		

Id	Business Process	CSD	Control/Restriction rule description ¹⁴¹				Impact Assessment				Additional comments
			Name	Object restriction type	Restriction processing type	Description of the control	Criterion 1 Character of the service / process	Criterion 2 Effort of implementing controls in Investor CSD's structure	Criterion 3 Risk of <u>not</u> implementing controls in Investor CSD's structure	Status	
250	Other Regulatory Compliance	Euroclear Finland	WATI	Settlement Instruction	Rejection (Positive)	Settlement instructions sent by CSD Participants on accounts undergoing whole account transfer (identified with MSA – “CSDFROZEN” – status “Y”) are rejected.	Necessary: The service is necessary according to the definition.	High: The control is based on the implementation of MSAs therefore the impact is high.	None: Impact is none because the accounts subject to rejection are not held by Investor CSDs.		
251	Corporate Actions	Euroclear Finland	RTBS	Security	Blocking (Negative)	During the processing of certain Corporate Actions, block all settlement instructions in the concerned ISIN, except if sent using “CORP” ISO transaction code.	Necessary: The service is necessary according to the definition.	Low: The control is solely based on the implementation of restriction rules and is generally needed for the activity as Issuer CSD.	High: The impact is high as not implementing the control could result in settlement of securities that are restricted from settlement at the Issuer CSD.		
252	External CSD Settlement	Euroclear Finland	RS_1	Settlement Instruction	CoSD	For cross-CSD transactions involving a CSD external to T2S, the securities leg of the transaction is temporarily blocked until an external settlement condition has been fulfilled i.e. cash or securities settlement leg outside T2S.	Optional: The service is considered optional as Euroclear Finland is acting as Investor CSD of an External CSD and not as Issuer CSD, i.e. triggering the CoSD rules only in the case where the Issuer CSD is outside T2S.	Medium: The control is solely based on the implementation of a CoSD rule and is not needed for the activity as Issuer CSD.	Medium: Impact is medium as cross-CSD transactions could be pending and require bilateral cancellation of the settlement instructions		For cross-CSD transactions involving a CSD external to T2S, the rule RS_1 will be triggered in case of transaction with an Investor CSD of Euroclear Finland.