



TARGET Instant Payment Settlement

User Detailed Functional Specifications

R2023.NOV

| | |
|---------|------------|
| Author | 4CB |
| Version | R2023.NOV |
| Date | 05/05/2023 |

All rights reserved.

| | |
|--|-----------|
| INTRODUCTION | 10 |
| READER'S GUIDE | 11 |
| 1. GENERAL FEATURES OF TIPS | 13 |
| 1.1. INTRODUCTION TO THE TIPS SERVICE..... | 13 |
| 1.2. ACCESS TO TIPS | 15 |
| 1.2.1. Connectivity (A2A/U2A)..... | 16 |
| 1.2.2. Authentication and authorisation process..... | 16 |
| 1.2.3. Access rights | 17 |
| 1.2.4. Security | 18 |
| 1.2.4.1. Confidentiality..... | 18 |
| 1.2.4.2. Integrity | 18 |
| 1.2.4.3. Availability | 18 |
| 1.2.4.4. Monitoring..... | 19 |
| 1.2.4.5. Auditability | 19 |
| 1.2.5. Graphical user interface | 19 |
| 1.3. TIPS ACTORS AND ACCOUNT STRUCTURE | 20 |
| 1.3.1. Parties and TIPS Actors | 20 |
| 1.3.1.1. Setup of TIPS Actors | 21 |
| 1.3.1.2. Concept of party in TIPS..... | 21 |
| 1.3.1.3. Hierarchical party model..... | 23 |
| 1.3.1.4. Party identification..... | 23 |
| 1.3.1.5. Reference data for parties in TIPS..... | 24 |
| 1.3.2. Accounts structure and organisation..... | 27 |
| 1.3.2.1. TIPS Accounts | 28 |
| 1.3.2.2. TIPS AS Technical Accounts..... | 28 |
| 1.3.2.3. Transit Accounts | 28 |
| 1.3.2.4. Credit Memorandum Balance | 29 |
| 1.3.2.5. Reference data for accounts and CMBs in TIPS..... | 29 |
| 1.4. DYNAMIC DATA MODEL..... | 32 |
| 1.4.1. Payment Transaction | 32 |
| 1.4.2. Liquidity Transfer..... | 34 |
| 1.4.3. Cash Posting | 35 |
| 1.4.4. Cash Balance..... | 36 |
| 1.4.5. CMB Headroom..... | 36 |
| 1.4.6. RTGS Systems..... | 37 |
| 1.5. TIPS FEATURES..... | 38 |
| 1.5.1. General concepts | 38 |
| 1.5.2. Settlement of Instant Payment transactions..... | 40 |
| 1.5.2.1. Instant Payment transaction settlement process (with reservation of funds) | 42 |

| | |
|--|-----------|
| 1.5.2.2. Instant Payment transaction settlement process (without reservation of funds) | 45 |
| 1.5.2.3. Recall settlement process | 47 |
| 1.5.2.4. Investigation process | 49 |
| 1.5.3. Liquidity Management | 50 |
| 1.5.3.1. Inbound Liquidity Transfer | 50 |
| 1.5.3.2. Outbound Liquidity Transfer | 52 |
| 1.5.3.3. Intra-service Liquidity Transfers | 53 |
| 1.5.3.4. Reserve calculation | 54 |
| 1.5.4. Reference data management | 55 |
| 1.5.4.1. Blocking Participants | 56 |
| 1.5.4.2. Blocking accounts and CMBs | 57 |
| 1.5.4.3. Limit management | 58 |
| 1.5.5. Queries and reports | 58 |
| 1.5.5.1. Queries | 58 |
| 1.5.5.2. Reports | 59 |
| 1.5.6. Raw Data extraction | 60 |
| 1.5.6.1. Raw data for Archiving | 60 |
| 1.5.6.2. Raw data for Billing | 61 |
| 1.5.6.3. Raw data for Statistics | 62 |
| 1.5.6.4. TIPS Consumption file | 62 |
| 1.5.6.4.1 Structure | 62 |
| 1.5.6.4.2 XML Envelope | 64 |
| 1.5.7. Statistical Indicators for Euro currency | 65 |
| 1.5.7.1. General SCT Inst | 66 |
| 1.5.7.1.1 Number of IP transactions per Amount | 66 |
| 1.5.7.1.2 Number of IP transactions per Hour | 67 |
| 1.5.7.1.3 Number of positive confirmation messages per duration of the processing | 67 |
| 1.5.7.1.4 Number of negative confirmation messages per duration of the processing | 67 |
| 1.5.7.1.5 Number of Investigation Requests processed by TIPS | 68 |
| 1.5.7.2. National Transactions | 68 |
| 1.5.7.2.1 Number of national IP transactions | 69 |
| 1.5.7.2.2 Number of national IP transactions with an unsettled status | 69 |
| 1.5.7.2.3 Number of national Recall Requests | 70 |
| 1.5.7.2.4 Number of national Unsettled IP transactions grouped by reason code | 70 |
| 1.5.7.2.5 Number of national Recall Requests grouped by reason code | 70 |
| 1.5.7.2.6 Number of national Request for Recall by Originator | 71 |
| 1.5.7.3. Cross-border Transactions | 71 |
| 1.5.7.3.1 Number of cross-border IP transactions | 72 |

| | | |
|---------------|--|-----------|
| 1.5.7.3.2 | Number of cross-border IP transactions with an unsettled status | 73 |
| 1.5.7.3.3 | Number of cross-border Recall Requests | 73 |
| 1.5.7.3.4 | Number of cross-border IP transactions with an unsettled status and grouped by reason code | 73 |
| 1.5.7.3.5 | Number of cross-border Recall Requests grouped by reason code | 74 |
| 1.5.7.3.6 | Number of cross-border Request for Recall by Originator | 75 |
| 1.5.7.4. | Overall monthly figures on payment transactions processed by TIPS | 75 |
| 1.5.7.4.1 | Volume of national payment transactions | 75 |
| 1.5.7.4.2 | Value of national payment transactions | 76 |
| 1.5.7.4.3 | Volume of cross-border payment transactions | 76 |
| 1.5.7.4.4 | Value of cross-border payment transactions | 76 |
| 1.5.8. | Statistical Indicators for non-Euro currency | 76 |
| 1.5.8.1. | General figures | 77 |
| 1.5.8.1.1 | Number of IP transactions in SEK per Amount | 77 |
| 1.5.8.1.2 | Number of IP transactions in SEK per Hour | 78 |
| 1.5.8.1.3 | Number of positive confirmation messages per duration of the processing | 79 |
| 1.5.8.1.4 | Number of negative confirmation messages per duration of the processing | 79 |
| 1.5.8.1.5 | Number of Investigation Requests processed by TIPS | 80 |
| 1.5.8.2. | National Transactions | 80 |
| 1.5.8.2.1 | Number of national IP transactions | 81 |
| 1.5.8.2.2 | Number of national IP transactions with an unsettled status | 81 |
| 1.5.8.2.3 | Number of national Recall Requests | 82 |
| 1.5.8.2.4 | Number of national Unsettled IP transactions grouped by reason code | 82 |
| 1.5.8.2.5 | Number of national Recall Requests grouped by reason code | 82 |
| 1.5.8.2.6 | Number of national Request for Recall by Originator | 83 |
| 1.5.8.2.7 | Overall monthly figures on payment transactions processed by TIPS | 83 |
| 1.5.8.2.8 | Volume of national payment transactions | 84 |
| 1.5.8.2.9 | Value of national payment transactions | 84 |
| 1.6. | INTERACTIONS WITH OTHER SERVICES | 84 |
| 1.6.1. | T2 and other RTGS Systems | 84 |
| 1.6.1.1. | Liquidity Transfer management | 85 |
| 1.6.1.2. | Closure of the RTGS System | 86 |
| 1.6.1.3. | Change of business date of the RTGS System | 87 |
| 1.6.1.4. | TIPS General Ledger | 89 |
| 1.6.1.4.1 | TIPS General Ledgers production | 89 |
| 1.6.1.4.2 | Content | 89 |
| 1.6.1.5. | TIPS Snapshot | 89 |

| | |
|--|------------|
| 1.6.1.5.1 TIPS Snapshot production..... | 91 |
| 1.6.2. Eurosystem Single Market Infrastructure Gateway | 91 |
| 1.6.3. Common Reference Data Management..... | 92 |
| 1.6.4. Archiving..... | 94 |
| 1.6.5. Billing | 94 |
| 1.7. OPERATIONS AND SUPPORT | 95 |
| 1.7.1. Service configuration | 95 |
| 1.7.2. Business and operations monitoring | 97 |
| 1.7.3. Archiving management..... | 98 |
| 2. DIALOGUE BETWEEN TIPS AND TIPS ACTORS | 99 |
| 2.1. MESSAGE ROUTING | 99 |
| 2.2. INSTANT PAYMENT TRANSACTION | 104 |
| 2.2.1. Instant Payment (SCT^{Inst} scheme) | 104 |
| 2.2.1.1. Timeout scenario: missing/delayed Beneficiary-side answer | 114 |
| 2.2.1.2. Examples..... | 117 |
| 2.2.1.2.1 Successful scenario with confirmed order – only accounts involved | 119 |
| 2.2.1.2.2 Successful scenario with confirmed order – Creditor account and debtor CMB..... | 121 |
| 2.2.1.2.3 Successful scenario with confirmed order – Creditor CMB and debtor Account | 124 |
| 2.2.1.2.4 Successful scenario with rejected order | 127 |
| 2.2.1.2.5 Successful scenario instant payment via TIPS AS Technical Account..... | 130 |
| 2.2.1.2.6 Error scenarios | 133 |
| 2.2.1.2.7 Delayed Beneficiary-side answer scenario | 139 |
| 2.2.2. Instant Payment (non-Euro currencies scheme) | 142 |
| 2.2.2.1. Timeout scenario: missing/delayed Beneficiary-side answer (non-Euro currencies scheme) | 152 |
| 2.2.2.2. Examples (non-Euro currencies scheme)..... | 155 |
| 2.2.2.2.1 Successful scenario with confirmed order – only accounts involved | 157 |
| 2.2.2.2.2 Successful scenario with confirmed order – Creditor account and debtor CMB..... | 159 |
| 2.2.2.2.3 Successful scenario with confirmed order – Creditor CMB and debtor Account | 162 |
| 2.2.2.2.4 Successful scenario with rejected order | 165 |
| 2.2.2.2.5 Error scenarios | 168 |
| 2.2.2.2.6 Delayed Beneficiary-side answer scenario | 175 |
| 2.2.3. Instant Payment (SIP settlement model) | 179 |
| 2.2.3.1. Examples..... | 186 |
| 2.2.3.1.1 Successful scenario – Euro currency – only accounts involved | 188 |

| | |
|--|------------|
| 2.2.3.1.2 Successful scenario – Euro currency – Creditor account and debtor CMB | 189 |
| 2.2.3.1.3 Successful scenario – non-Euro currency – only accounts involved | 191 |
| 2.2.3.1.4 Successful scenario – non-Euro currency – Creditor CMB and debtor account | 193 |
| 2.2.3.1.5 Error scenarios | 195 |
| 2.3. RECALL | 199 |
| 2.3.1. Examples | 209 |
| 2.3.1.1. Successful scenario – Positive Recall Response | 209 |
| 2.3.1.2. Successful scenario – Negative Recall Response | 212 |
| 2.3.1.3. Unsuccessful scenario – Recall Response Duplicate check failed | 214 |
| 2.3.1.4. Successful scenario – Request for Status Update on a Recall | 216 |
| 2.3.1.5. Successful scenario – Positive Recall Response with Ancillary System processing | 217 |
| 2.4. INVESTIGATION | 221 |
| 2.4.1. Examples | 225 |
| 2.4.1.1. Successful scenario – Transaction status investigation | 226 |
| 2.4.1.2. Unsuccessful scenario – Transaction status investigation | 227 |
| 2.4.1.3. Successful scenario – Transaction status investigation generated by an Ancillary System | 228 |
| 2.5. INBOUND/OUTBOUND AND INTRA-SERVICE LIQUIDITY TRANSFERS | 230 |
| 2.5.1. Inbound Liquidity Transfer | 230 |
| 2.5.1.1. Examples | 235 |
| 2.5.1.1.1 Successful scenario – Inbound Liquidity Transfer order is settled in TIPS | 236 |
| 2.5.1.1.2 Unsuccessful scenario: Inbound LT order is rejected because LT duplicate check failed | 237 |
| 2.5.2. Outbound Liquidity Transfer | 239 |
| 2.5.2.1. Examples | 247 |
| 2.5.2.1.1 Successful scenario – Outbound LT order settled in TIPS and RTGS System | 248 |
| 2.5.2.1.2 Unsuccessful scenario – Outbound LT order rejected for insufficient funds in TIPS | 250 |
| 2.5.2.1.3 Unsuccessful scenario – Outbound LT order rejected by the RTGS System | 252 |
| 2.5.2.2. RTGS Alert scenario – No reply from RTGS System | 254 |
| 2.5.3. Intra-service Liquidity Transfer | 256 |
| 2.5.3.1. Examples | 261 |
| 2.5.3.1.1 Successful scenario – Intra-service LT successfully settled | 261 |
| 2.5.3.1.2 Unsuccessful scenario – intra-service LT order rejected for insufficient funds in TIPS | 264 |
| 2.6. NOTIFICATIONS | 266 |
| 2.6.1. Floor notification on account | 266 |

| | |
|---|------------|
| 2.6.2. Ceiling notification on CMB | 268 |
| 2.7. QUERIES..... | 269 |
| 2.7.1. Examples | 279 |
| 2.7.1.1. Successful scenario – Account balance and status query | 280 |
| 2.7.1.2. Successful scenario – CMB limit and status query | 281 |
| 2.7.1.3. Unsuccessful scenario – TIPS Account/CMB not found..... | 282 |
| 2.7.1.4. Successful scenario – Payment transaction status query | 283 |
| 2.7.1.5. Unsuccessful scenario – Payment transaction status query .. | 284 |
| 2.8. REPORTS..... | 285 |
| 2.8.1. Statement of Account Turnover | 286 |
| 2.8.1.1. Examples..... | 288 |
| 2.8.1.1.1 Statement of Account Turnover | 289 |
| 2.8.2. Statement of Accounts | 291 |
| 2.8.2.1. Examples..... | 294 |
| 2.8.2.1.1 Statement of Accounts – Full mode..... | 295 |
| 2.8.2.1.2 Statement of Accounts – Delta mode..... | 297 |
| 2.8.3. Report naming convention | 301 |
| 2.9. REFERENCE DATA MANAGEMENT..... | 301 |
| 2.9.1. Examples | 309 |
| 2.9.1.1. Successful scenario – Block of a TIPS Participant..... | 309 |
| 2.9.1.2. Successful scenario – Block of an Ancillary System..... | 311 |
| 2.9.1.3. Successful scenario – Unblock of a TIPS Participant..... | 312 |
| 2.9.1.4. Unsuccessful scenario – Party not existing | 313 |
| 2.9.1.5. Successful scenario – Block of a CMB..... | 314 |
| 2.9.1.6. Successful scenario – Unblock of an Account..... | 315 |
| 2.9.1.7. Unsuccessful scenario – Restriction type not allowed..... | 316 |
| 2.9.1.8. Successful scenario – Decrease of a CMB Limit | 317 |
| 2.9.1.9. Unsuccessful scenario – User not allowed to change the Limit | 319 |
| 3. CATALOGUE OF MESSAGES | 320 |
| 3.1. INTRODUCTION | 320 |
| 3.2. GENERAL INFORMATION | 320 |
| 3.2.1. Message signing | 320 |
| 3.2.2. Technical validation | 321 |
| 3.2.3. Supported Character Set | 321 |
| 3.3. MESSAGES USAGE..... | 321 |
| 3.3.1. List of messages | 321 |
| 3.3.2. Messages description | 325 |
| 3.3.2.1. Payments Clearing and Settlement | 325 |
| 3.3.2.1.1 FIToFIPaymentStatusReport (pacs.002.001.10) | 325 |
| 3.3.2.1.2 PaymentReturn (pacs.004.001.09) | 328 |
| 3.3.2.1.3 FIToFICustomerCreditTransfer (pacs.008.001.08) | 333 |
| 3.3.2.1.4 FIToFIPaymentStatusRequest (pacs.028.001.03) | 339 |

| | |
|---|-----|
| 3.3.2.1.5 FIToFIPaymentStatusReport (pacs.002.001.10) | 343 |
| 3.3.2.1.6 FIToFICustomerCreditTransfer (pacs.008.001.08) | 346 |
| 3.3.2.1.7 PaymentReturn (pacs.004.001.09) | 354 |
| 3.3.2.1.8 FIToFIPaymentStatusRequest (pacs.028.001.03) | 359 |
| 3.3.2.2. Cash Management (camt) | 363 |
| 3.3.2.2.1 GetAccount (camt.003.001.06) | 363 |
| 3.3.2.2.2 ReturnAccount (camt.004.001.07) | 364 |
| 3.3.2.2.3 GetTransaction (camt.005.001.07) | 368 |
| 3.3.2.2.4 ReturnTransaction (camt.006.001.07) | 369 |
| 3.3.2.2.5 ModifyLimit (camt.011.001.07) | 372 |
| 3.3.2.2.6 ReturnBusinessDayInformation (camt.019.001.07) | 372 |
| 3.3.2.2.7 Receipt (camt.025.001.05) | 374 |
| 3.3.2.2.8 Receipt (camt.025.001.04) | 375 |
| 3.3.2.2.9 ResolutionOfInvestigation (camt.029.001.09) | 376 |
| 3.3.2.2.10 LiquidityCreditTransfer (camt.050.001.05) | 379 |
| 3.3.2.2.11 BankToCustomerAccountReport (camt.052.001.06) | 382 |
| 3.3.2.2.12 BankToCustomerStatement (camt.053.001.06) | 383 |
| 3.3.2.2.13 BankToCustomerStatement (camt.053.001.08) | 386 |
| 3.3.2.2.14 BankToCustomerDebitCreditNotification (camt.054.001.06) | 387 |
| 3.3.2.2.15 FIToFIPaymentCancellationRequest (camt.056.001.08) ... | 389 |
| 3.3.2.2.16 FIToFIPaymentCancellationRequest (camt.056.001.08) ... | 392 |
| 3.3.2.2.17 ResolutionOfInvestigation (camt.029.001.09) | 395 |
| 3.3.2.3. Account Management (acmt) | 399 |
| 3.3.2.3.1 AccountRequestAcknowledgement (acmt.010.001.02) | 399 |
| 3.3.2.3.2 AccountRequestRejection (acmt.011.001.02) | 400 |
| 3.3.2.3.3 AccountExcludedMandateMaintenanceRequest (acmt.015.001.02) | 401 |
| 3.3.2.4. Reference Data (reda) | 403 |
| 3.3.2.4.1 PartyStatusAdvice (reda.016.001.01) | 403 |
| 3.3.2.4.2 PartyModificationRequest (reda.022.001.01) | 404 |

| | |
|--|------------|
| 4. APPENDICES | 407 |
| 4.1. BUSINESS RULES | 407 |
| 4.2. LIST OF ERROR CODES | 417 |
| 4.2.1. List of ISO Error codes | 417 |
| 4.2.2. List of non-ISO Error codes | 418 |
| 4.3. LIST OF INDICATORS | 419 |
| 4.3.1. List of general SCT Inst Indicators | 419 |
| 4.3.2. List of National Transactions indicators for euro currency ... | 419 |
| 4.3.3. List of cross-border Transactions indicators for euro currency | 420 |
| 4.3.4. List of general indicators for non-Euro currencies | 422 |
| 4.3.5. List of National Transactions indicators for non-Euro currencies | 424 |

| | |
|--|-----|
| 4.4. INDEX OF FIGURES..... | 426 |
| 4.5. INDEX OF TABLES..... | 432 |
| 4.6. LIST OF ACRONYMS..... | 435 |
| 4.7. LIST OF REFERENCED DOCUMENTS..... | 436 |

Introduction

This document describes all the features of the TIPS service and TIPS Actors' interactions with it, focusing on application-to-application communication.

This document is intended to guide TIPS Actors to the proper understanding of the service and to offer all the information needed for the implementation of software interfaces on their side.

The UDFS document focuses on the provision of information to TIPS Actors to design and build the interface of their business applications with TIPS (A2A) and it is available for the whole community: in order to ensure the same level of knowledge for all TIPS Actors the information relevant for CBs, TIPS Participants, Ancillary Systems, Reachable Parties, Instructing Parties and the TIPS Operator is contained in one single book of UDFS.

The document is divided into three main chapters:

- The **first chapter** provides a full description of all the TIPS features and the related reference and transactional data models, non-technical details concerning access to the service and connectivity, dependencies and interactions with other services, operations and support features. The background information provided in Chapter [1](#) guides the understanding of Chapter [2](#). Information provided in Chapter [1](#) on the TIPS feature is mainly user-oriented, but it also includes some details on the internal TIPS processes, when relevant.
- The **second chapter** provides a formalized description of the (A2A) dialogues, which allow TIPS Actors' applications to interact with TIPS. This part aims at providing an exhaustive description of the different (successful and unsuccessful) use cases TIPS actors may face, by providing many detailed examples. The section guides the reader through the steps of the different scenarios – highlighting the actions undertaken by TIPS and all the involved TIPS Actors. The following parts compose a scenario:
 - o End-to-end description of the process – by means of activity diagrams and explanatory text;
 - o Involved actors;
 - o Exchanged messages;
 - o List of meaningful business cases.

The description of each step of the process includes an exhaustive list of all the checks performed by TIPS. The detailed description of the business rules is reported in the list at the end of the document ([4.1 "Business Rules"](#)).

- The list of meaningful business cases is composed by:
 - o A sample data constellation;
 - o The content of the main fields of the relevant inbound messages;
 - o A description of the main steps taking place in TIPS;
 - o The content of the main fields of the resulting outbound messages.

- The **third chapter** provides a detailed description of all XML messages
- Actors may use to interact in A2A mode with TIPS. Each message specification includes the following elements:
 - o Reference name and identifier – e.g. LiquidityCreditTransfer (camt.050.001.05)
 - o List of fields included in the message. Each field specification includes the following elements:
 - EPC Reference (if applicable)
 - Reference name
 - Short description
 - XML Path
 - Boolean attribute specifying whether the field is used in TIPS
 - Boolean attribute specifying whether the field is mandatory or not

Wherever a message or its fields are referenced throughout the document, only the reference name is used.

Reader's guide

The document is structured as to guide the readers through the steps of the whole A2A interaction and processing details as exemplified by the figure below.

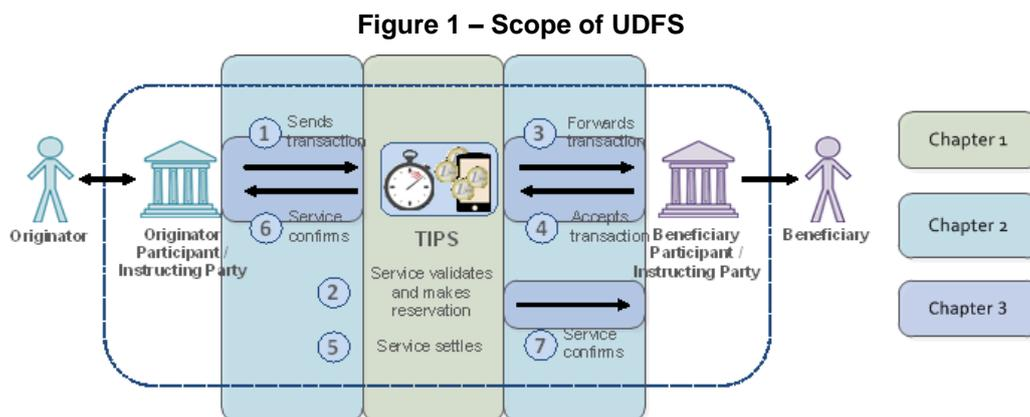

Different readers may have different needs and priorities and may not need to read the whole book. For instance, business readers, interested mainly in organisational issues, may not wish to enter into the full details of each and every message description, but they might prefer going through a description of the application processes and the information flows between their own business applications and the TIPS service. On the other hand, technical readers involved in the specification and development of technical interfaces to TIPS may not be interested in the complete description of the TIPS application processes that are leading to the sending of a given message. They would probably search the necessary

information to design and build the interface of the TIPS Actors' business application with TIPS service. Every reader can decide their own reading plan and it is not mandatory for every reader to read the entire UDFS book.

The following paragraphs show with a couple of examples how business readers and technical readers may follow different reading patterns, in order to fulfil their needs.

Business oriented perspective

The business reader may be interested in the way information is structured in TIPS. This user may want to follow the reading plan described below to find information about the operations that are needed in order to process an Instant Payment in TIPS:

- The business reader finds in section [1.3 "TIPS Actors and account structure"](#) a general description of the main Reference data needed to work on TIPS, specifying how they are used for the settlement of Instant Payment transactions (e.g. what is a Participant and the related Accounts it owns and how to authorise a BIC to use an account to settle Instant Payment transactions). Also section [1.4 "Dynamic data model"](#) is important to understand how the information is managed in TIPS.
- From this point, the business reader may jump to section [2.2 "Instant Payment transaction "](#) to find a description of the processing of an Instant Payment. Here they can find useful examples in order to understand the main scenarios involving Instant Payments.
- For further details on the validations to be performed, they may jump to section [4.1 "Business Rules"](#), where the functional checks are described.

Technical oriented perspective

For a technical reader, it is more likely that the reading plans would pass through:

- Chapter [2 "Dialogue between TIPS and TIPS Actors"](#), where a complete overview of the possible A2A dialogue with TIPS is required, e.g. when structuring the interface of a TIPS Actor towards TIPS. Each sub-section of this chapter describes, then, the flows involving the functionalities of TIPS. The readers can focus on the functionality they are interested in analysing the process and the main scenarios.
- Chapter [3 "Catalogue of messages"](#), where a detailed description of the content of a given XML message is provided, e.g. when specifying the details of the interface of a TIPS Actor towards TIPS.
- For further details on the checks to be performed and ISO codes used in the message, they may jump to chapter [4 "Appendices"](#).

All readers, whether business or technical, are invited to read the following UDFS sections, which are providing a background to the understanding of any other UDFS section:

- [1.3 "TIPS Actors and account structure"](#), which provides the basis for reference data organisation in TIPS;

- [1.5 "TIPS Features"](#), which is a summary providing the basis for the understanding of the main TIPS concepts (access to TIPS, authentication and authorisation processes, security).

1. General features of TIPS

The present chapter, after a short introduction of the TIPS service, describes all the features provided by the service.

Section [1.2](#) introduces the details regarding the access of TIPS Actors to TIPS, covering the different modes of connectivity, the authentication and authorisation processes, as well as security aspects and an introduction to the Graphical User Interface (GUI).

Sections [1.3](#) and [1.4](#) describe respectively the reference data and the dynamic data models of TIPS, including a description of all the relevant entities and their relationships.

Section [1.5](#) describes the various features of TIPS and the underlying business processes, including Instant Payment settlement, liquidity management, reference data management, queries, reports and archiving.

Section [1.6](#) describes the interactions that TIPS, as a part of the Eurosystem Market Infrastructure, has with the other main services provided by the Eurosystem.

The last section describes processes supporting the TIPS Operator in the operational management of the system and the exact perimeter of the system introducing its limitations.

1.1. Introduction to the TIPS Service

TARGET Instant Payment Settlement (TIPS) is a harmonised and standardised pan-European service with common functionality across different countries and jurisdictions for settling payments instantly in Central Bank Money, with high capacity and around-the-clock availability.

The primary aim of TIPS is to offer instant settlement services in euro to its participants, extending the services offered by TARGET2. TIPS is, in any case, designed to be currency-agnostic in order to provide settlement in non-euro Central Bank Money, if requested, by connecting to any RTGS System.

The TIPS service provides:

- Real-time gross settlement in Central Bank Money for both domestic and cross-border Instant Payment transactions received from TIPS Actors;
- Liquidity management functionalities to support the Instant Payment process;
- Queries and reporting tools to support monitoring and reconciliation.

In order to reach these objectives, TIPS enables communication and provides authentication services and secure messaging to and from the centralised settlement component. The participants (i.e. Payment

Service Providers¹ or PSPs) have a settlement interface to send Instant Payment transactions and receive payment confirmations or any other payment related messages based – when possible – on ISO 20022 standards and in accordance with the SEPA Instant Credit Transfer (SCT^{Inst}) scheme. The participants are also provided with the functionalities to either recall settled Instant Payments transactions or initiate investigations on Instant Payments submitted to TIPS whose status confirmation has not been received yet. Additionally, TIPS Participants or Instructing Parties can initiate Outbound Liquidity Transfers.

TIPS Accounts in euro are legally opened in TARGET2 by the responsible Central Bank and have to be dedicated to the settlement of Instant Payments transactions in TIPS. In the specific scenario of the RTGS System for euro (i.e. TARGET2 until the T2-T2S Consolidation go-live, T2-CLM afterwards), the TIPS Account balances are taken into account for the calculation of the minimum reserve and marginal lending facility. For this reason, a snapshot of the balance on the TIPS Account for the fulfilment of the minimum reserve requirement is taken at the closing time of TARGET2, immediately after the last execution of the Algorithm 3 (i.e. shortly after the Bank-to-Bank cut-off at 18:00 CET). TIPS Accounts in other currencies are legally opened in the relevant RTGS System by the responsible Central Bank and have to be dedicated to the settlement of Instant Payments transactions in TIPS in the given currency. Also these TIPS Accounts are captured in CRDM by the responsible Central Bank. The TIPS Accounts' balances denominated in other currencies are communicated to relevant RTGS System during its End-of-Day phase by means of a General Ledger file.

TIPS operates on a 24/7/365 basis and it makes use of the following components:

- The **Eurosystem Single Market Infrastructure Gateway (ESMIG)** which allows users to gain access to all Eurosystem services, including TIPS, after being authenticated and authorised to access the relevant service. The ESMIG, moreover, guarantees sanitisation of messages for security purposes and technical validation of the standard messages sent to the different services.
- The **Common Reference Data Management (CRDM)**, i.e. the centralised, harmonised reference data management component that handles in a single point all data that is shared by more than one Eurosystem service. The CRDM allows users to configure, create and keep up-to-date all the reference data needed in the different Eurosystem services, including TIPS. As an example, the setup of reference data related to a TIPS Participant like the creation of an account is up to the responsible National Central Bank (NCB) whereas a TIPS Participant is responsible for the setup and configuration of Credit Memorandum Balances (CMBs).
- The **Billing (BILL)** common component, which (i) produces invoices, (ii) delivers the invoices to the customers and (iii) optionally debits the relevant accounts for the related amount based on consumption data it collects from TIPS.

¹ The definition of Payment Service Provider used in this document is purely technical and aims at keeping the terminology consistent with the EPC scheme and the TIPS URD.

- The **Legal Archiving (LeA)** component, which collects and stores business transaction and reporting data from different Eurosystem services, including TIPS. The Legal Archiving component stores data in a secure manner and in its original content and format and makes it accessible throughout a predefined retention period.
- The **Enhanced Information Database (EIDB)** component receives aggregated transactional data from the TIPS Operational Database on a daily basis, with a data retention period of three months. Aggregated data exploration and visualization is possible for authorized TIPS National Central Bank users through a dedicated tool (i.e. Apache Superset) reachable from the ESMIG Portal.

TIPS Actors can access TIPS through two different channels:

- **Application-to-Application (A2A)** channel, that is application-oriented and allows TIPS Actors' systems to interact with TIPS;
- **User-to-Application (U2A)** channel, that is user-oriented and offers human-friendly application access through a Graphical User Interface (GUI).

1.2. Access to TIPS

The purpose of this section is to introduce the basic connectivity to TIPS. It does not aim to describe in details the technical connection with TIPS.

TIPS Actors access TIPS, in A2A or U2A mode, via the respective Network Service Providers (NSPs) and through the ESMIG component. TIPS Actors must bilaterally define a relationship with one or more selected NSPs for the purpose of getting connected to TIPS.

Figure 2 – TIPS Connectivity

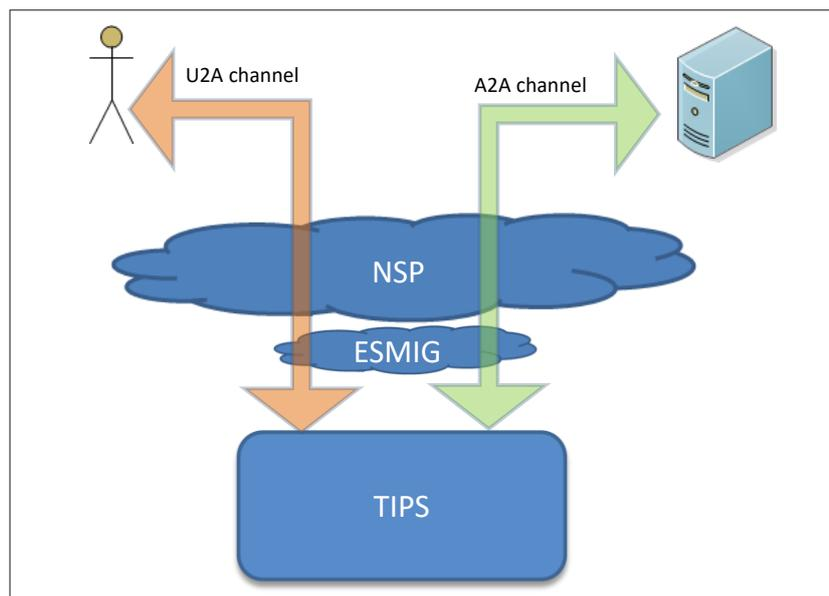

1.2.1. Connectivity (A2A/U2A)

TIPS supports access to the service through two different channels: Application-to-Application (A2A) channel and User-to-Application (U2A) channel.

- A2A: software applications can communicate with TIPS exchanging single messages. A2A communication relies on ISO 20022 standard XML messages, where applicable, for both inbound and outbound communication. Otherwise, i.e. when there is no ISO 20022 standard message available or when the usage of XML technology is not advisable for technical reasons (e.g. performance or network traffic constraints) flat data files may be used. At the current stage, there is no business case requiring flat data files to be used instead of ISO 20022 standard messages.

All the exchanges of messages are executed through a realtime transfer service. This means that both parties (i.e. the Originator Participant and Instructing Party acting on behalf of the Originator Participant or Reachable Party on one side and the Beneficiary Participant and Instructing Party acting on behalf of the Beneficiary Participant or Reachable Party on the other side) must be available and reachable when the message is sent. In case the message cannot be delivered, no retry mechanism is foreseen.

- U2A: for specific functionalities, the TIPS Actors can access TIPS through a Graphical User Interface. This channel is foreseen for a small subset of functionalities and queries (see [1.2.5 "Graphical user interface"](#)).

1.2.2. Authentication and authorisation process

Any individual or application interacting with TIPS is identified by a Distinguished Name (DN). A DN is a sequence of attribute-value assertions separated by commas, e.g.:

<cn=smith,ou=tips-ops,o=bnkacct,o=nsp-1>

DNs are uniquely linked to digital certificates², which TIPS Actors assign to their individuals (interacting with TIPS in U2A mode) or applications (interacting with TIPS in A2A mode).

Certificates are issued by each NSP. For each request submitted to TIPS in U2A and A2A mode, the relevant connectivity provider performs authentication of the sender at network infrastructure level. If the authentication is successful, the connectivity provider forwards the request and the sender's DN to the ESMIG component.

The ESMIG component carries out an authorisation check at service level, in order to verify whether the DN is enabled to submit requests to TIPS. The ESMIG documentation contains exhaustive information on all the checks the ESMIG carries out. If these checks are successful, the request and the sender's DN are forwarded to TIPS.

² A digital certificate is an electronic document binding an identity to a pair of electronic keys, a private key (used to sign digital information to be sent to a counterpart or to decrypt digital information received from a counterpart) and a public key (used to encrypt digital information to be sent to a counterpart or to perform the authentication and to ensure the integrity of digital information received from a counterpart).

TIPS then carries out the authorisation of the sender at application level based on the DN's access rights profile. Section [1.2.3 "Access rights"](#) provides details on this process.

Distinguished Names, their connection to TIPS Actors, as well as access rights profiles and authorisations for DN's to submit requests related to specific BICs are defined in the Common Reference Data Management (CRDM) component. Additional information on the setup of access rights and on the underlying concepts can be found in the CRDM documentation.

1.2.3. Access rights

TIPS authorises requests from specific users (i.e. individuals or applications identified by means of a DN) based on their relevant access rights profile. Each interaction with TIPS that can be triggered either in A2A mode by means of a message (e.g. sending an Instant Payment transaction) or U2A mode via GUI screen (e.g. blocking of a TIPS Account) is defined as a TIPS user function. The capability to trigger a specific TIPS user function is granted by means of the related Privilege.

All Privileges that are relevant for TIPS are defined and stored within the CRDM, which also offers the possibility to group different Privileges into sets known as Roles. Each of these Roles will define a specific business role for TIPS Actors to use to interact with TIPS. TIPS users will be assigned one or more roles in the CRDM depending on their requirements, and these roles will define their access rights configuration.

Roles are then granted to users identified by specific DN's. This allows the DN linked to the Role to trigger user functions in TIPS by exercising the Privileges contained within the Role.

TIPS authorises the sender of a given request only if the DN fulfils both of the following conditions:

1. The DN has the relevant privilege(s) required to submit the request;
2. The DN is enabled to submit the request on the requested business object(s).

The first condition depends on the DN's access rights profile, which is defined by the role(s) assigned to it in the CRDM. For example, a DN may be enabled to send Instant Payment transactions but not liquidity transfers.

The second condition is based on the business object itself on which a request is being performed. For instance, in an Instant Payment transaction, the object is represented by the TIPS Account being debited; in an Account balance and status query, the object is the TIPS Account being queried. TIPS applies specific business logic, which differs depending on the type of request, to determine whether a certain DN is authorised to act on a certain object. If a certain DN is authorised to exercise a type of request (related to a specific Privilege) on a specific object, that object is said to be within the DN's data scope for that Privilege.

The concept of Instructing Party is also defined in this way. Instructing Parties are DN's that are authorised to send or receive instructions on behalf of a specific Party. This configuration is defined by means of a relationship set up within the CRDM.

The entire access rights configuration process is carried out within the CRDM: the CRDM documentation provides additional details on these aspects.

1.2.4. Security

This section aims at describing the main processes performed by TIPS in terms of principles applied to ensure TIPS Actors can securely exchange information with TIPS.

It means that the following security conditions are met:

- **Confidentiality:** Ensuring that information is accessible only to authenticated and authorised TIPS Actors;
- **Integrity:** Safeguarding the accuracy and completeness of information;
- **Availability:** Ensuring that authorised users have access to information and associated assets when required;
- **Monitoring:** Detecting operational and technical problems and recording appropriate information for crisis management scenarios and future investigations;
- **Auditability:** Ensuring the possibility to establish whether a system is functioning properly and that it has worked properly.

1.2.4.1. Confidentiality

The confidentiality of data is ensured by the possibility to grant specific access rights for any given set of data, as detailed in section [1.2.3 "Access rights"](#). In conjunction with mechanisms of authentication and authorisation applied to all requests received by TIPS in both A2A and U2A mode, this guarantees that each TIPS Actor's data is treated confidentially and is not accessible to non-authorised actors.

1.2.4.2. Integrity

Within TIPS, various business validations ensure the integrity of information. If a business validation fails, TIPS has a concept of Error handling in place. The requested action is not processed and TIPS provides the user with detailed information regarding the nature of the error.

In U2A mode, TIPS offers users in addition the possibility to further ensure the data integrity via usage of a dual authorisation concept, the 4-Eyes principle. In case this option is chosen for a specified set of TIPS operations, a second independent verification and confirmation is required before an operation becomes active in TIPS. If, for example, a critical set of data should be modified and the person requesting the change is only allowed to do so under the 4-Eyes principle, then a second person of the same Party has to confirm the correctness of the request. Otherwise, the requested change is not implemented.

1.2.4.3. Availability

The overall availability of the TIPS services is ensured by the innovative architectural design, and is pursued through node redundancy and self-recovery capability (built at application level). In the event of unavailability of some local nodes of the application cluster or unavailability of an entire site, TIPS adapts its behaviour as far as possible to continue operating.

1.2.4.4. Monitoring

TIPS operational monitoring provides tools to the TIPS Operator for the detection in real-time of functional or operational problems. Technical monitoring allows for the detection of hardware and software problems via real-time monitoring of the technical components involved in the processing, including the network connections.

1.2.4.5. Auditability

TIPS provides an audit trail with which it is possible to reconstruct user activities, exceptions and information security events. More in detail, the following data are collected:

- payment transaction and liquidity transfer records;
- authentication successes and failures of normal and privileged users;
- security related messages (e.g. changes of access rights, alerts and exceptional events).

1.2.5. Graphical user interface

TIPS offers a set of functions accessible via a dedicated Graphical User Interface (GUI) in U2A mode. Authorised users are able to access TIPS functions and data via the GUI based on their access rights profile.

The following table provides the exhaustive list of TIPS U2A functions provided through the GUI.

Each TIPS Actor may trigger all or only a subset of these functions depending on the participant type (e.g. Central Bank, TIPS Participant, etc.) and only in relation to the objects in its own data scope. These functions, with the exception of the Advanced Payment Transaction status query and the Advanced Liquidity Transfer status query, which may be subject to a less restrictive service level agreement, are available on a 24/7/365 basis.

Table 1 – TIPS U2A functions

| Function | Actor |
|--|---|
| Block/Unblock TIPS Participant and Ancillary System | CB, TIPS Operator ³ |
| Block/Unblock TIPS Account and TIPS AS Technical Account | CB, TIPS Operator ³ |
| Block/Unblock Credit Memorandum Balance | TIPS Participant, Ancillary System, Instructing Party ⁴ , CB, TIPS Operator |

³ TIPS Operator can block TIPS Participants, Ancillary Systems, TIPS Accounts or TIPS AS Technical Accounts in contingency and upon request of the responsible Central Bank.

⁴ An Instructing Party acting on behalf of a TIPS Participant or an Ancillary System may block/unblock CMBs owned by the relevant TIPS Participant or Ancillary System, unless restricted via access rights.

| Function | Actor |
|--|--|
| Adjust Credit Memorandum Balance Limit | TIPS Participant, Ancillary System, Instructing Party ⁵ , CB, TIPS Operator |
| Query Account Balances and Status | TIPS Participant, Ancillary System, Instructing Party, CB, TIPS Operator |
| Query CMB Limit and Status | TIPS Participant, Ancillary System, Instructing Party, CB, TIPS Operator |
| Query Payment Transaction Status | TIPS Participant, Ancillary System, Instructing Party, CB, TIPS Operator |
| Advanced Payment Transaction Status | TIPS Participant, Ancillary System, Instructing Party, CB, TIPS Operator |
| Liquidity Transfer Status | TIPS Participant, Ancillary System, Instructing Party, CB, TIPS Operator |
| Advanced Liquidity Transfer Status | TIPS Participant, Ancillary System, Instructing Party, CB, TIPS Operator |
| Initiate Outbound/Intra-service Liquidity Transfer | TIPS Participant, Ancillary System, Instructing Party ⁶ , CB, TIPS Operator |

The TIPS User Handbook (see [TARGET Instant Payment Settlement User Handbook](#)) provides exhaustive information on each of the screens listed above, including the type of actors authorised to trigger the corresponding functionality.

1.3. TIPS Actors and account structure

1.3.1. Parties and TIPS Actors

Entities that interact with the TIPS service are generally known as TIPS Actors. The TIPS participation model envisions different types of Actors, with different roles and responsibilities, as outlined in section [1.3.1.2. "Concept of party in TIPS"](#) TIPS Actors are defined as different entities in the Common Reference Data Management component.

This section provides a detailed description of all the reference data CRDM stores and TIPS uses for all TIPS Actors. More in detail, section [1.3.1.1](#) identifies the reference data related to the setup of actors for TIPS and it provides detailed information as to who is responsible for the setup of these reference

⁵ An Instructing Party acting on behalf of a TIPS Participant or an Ancillary System may adjust the limit of the CMBs owned by the relevant TIPS Participant or Ancillary System, unless restricted via access rights.

⁶ An Instructing Party acting on behalf of a TIPS Participant may be authorised to instruct Liquidity Transfers.

data. Section [1.3.1.2](#) defines the concept of party in the CRDM component and the way this concept relates with the different types of legal entities that can interact with TIPS. Section [1.3.1.3](#) describes the so-called hierarchical party model, i.e. the organisational structure of parties in the CRDM repository. Sections [1.3.1.4](#) and [1.3.1.5](#) illustrate in detail the reference data required by TIPS for each actor, i.e. the way a party can be identified in TIPS and which attributes have to be stored for each actor.

1.3.1.1. Setup of TIPS Actors

The setup of TIPS Actors takes place in the Common Reference Data Management component.

The TIPS Operator is responsible for setting up and maintaining party reference data for all Central Banks in TIPS. Central Banks are responsible for setting up and maintaining party reference data for the parties of their national community. In addition, each party can set up data for their individual Instructing Parties.

The following table summarises, for each reference data object related to the setup of TIPS Actors, the Actor responsible for its configuration and it specifies which mode the Actor can use for the configuration.

Table 2 – Setup of Parties for TIPS

| Reference Data Object | Responsible Actor | Mode |
|--------------------------|---|----------|
| Party (CB) | TIPS Operator | U2A |
| Party (Participant) | Central Bank | U2A, A2A |
| Party (Reachable Party) | Central Bank | U2A, A2A |
| Party (Ancillary System) | Central Bank | U2A, A2A |
| Instructing Party | Central Bank ⁷ , TIPS Participant, Ancillary System, Reachable Party | U2A |

1.3.1.2. Concept of party in TIPS

Any TIPS Actor, meaning any legal entity or organisation participating in and interacting with TIPS either directly or indirectly (i.e. through an Instructing Party), is defined as an entity in the Common Reference Data Management (CRDM) repository. Depending on their role in TIPS, TIPS Actors may be defined as a Party (or several parties, as explained later in this section) in CRDM. Each party belongs to one of the following party types:

- TIPS Operator
- Central Bank
- Participant
- Ancillary System

⁷ The Central Bank defines the Technical Address Network Service (TANSL) setup pertaining to instructing parties.

- Reachable Party

In addition, a TIPS Actor may act as an Instructing Party, which does not involve the definition of a specific Party.

The **TIPS Operator** is the legal and organisational entity that operates TIPS. They are responsible for the initial setup and day-to-day operations of TIPS and act as single point of contact for Central Banks and directly connected TIPS Actors⁸. They are responsible for monitoring the system and carrying out corrective actions in case of incidents or in the event of service unavailability. The TIPS Operator is also responsible for setting up and maintaining Central Banks reference data in the Common Reference Data Management repository and, if required, they may operate on behalf of any TIPS Actor, upon request of the respective Central Bank. They have full access to all live and all archived reference data and transactional data in TIPS.

Central Banks are responsible for setting up and maintaining reference data in the Common Reference Data Management repository for all the TIPS Actors belonging to their community. Central Banks can also act as Participants (see below) themselves. In addition and as far as the submission of liquidity transfers or the maintenance of reference data are concerned, they can act on behalf of one of their Actors in case of need. The European Central Bank owns and manages a single Transit Account (see section [1.3.2.3 "Transit Accounts"](#)) in euro that must exist in TIPS, in order to allow the transfer of liquidity from TARGET2 to TIPS and vice versa. With the same purpose, for each other settlement currency in TIPS, the relevant non-euro Central Bank shall define a single Transit Account for their currency.

Participants represent entities that hold one or more than one TIPS Accounts. They are identified by a BIC11 and they receive liquidity on their TIPS Accounts by means of Liquidity Transfers from the relevant RTGS System. In this respect, TIPS Participants do not necessarily own a TARGET2 PM account; therefore, a TIPS Participant may receive liquidity in TIPS from another TARGET2 Participant. TIPS Participants can setup and maintain CMBs (see section [1.3.2.4 "Credit Memorandum Balance"](#)) linked to their own accounts as well as configuring Instructing Party (see below) roles for themselves or for their Reachable Parties (see below). In addition, they define the access rights configuration of said Instructing Parties. They can also act as Instructing Parties as by definition they are able to specify DNS with the prerogatives of an Instructing Party for what concerns their own accounts (for details, see section [1.3.1.5](#) below).

Each **Ancillary System** holds a TIPS AS Technical Account for the settlement of Instant Payments and it is identified by a BIC11. The liquidity on the TIPS Technical Accounts is provided by the TIPS Accounts by means of intra-service Liquidity Transfers.

Reachable Parties are also identified by a BIC11, but they do not hold TIPS Accounts and have to rely on a Participant's account to settle payments in TIPS; they may be defined as responsible for one or more CMBs, allowing them to query the CMB data. They can also act as Instructing Parties, which allows them to interact directly with TIPS.

⁸ TIPS Actors different from Central Banks may contact the Service Desk only for connectivity-related incidents.

The role of **Instructing Party** allows an Actor to send (or receive) Instant Payments to (or from) TIPS. Instructing Parties are not defined as Parties, but as Distinguished Names that Participants and Reachable Parties can define and authorize to act on their behalf. This allows third parties, not necessarily TIPS Participants or a Reachable Parties, to act as Instructing Parties on behalf of other Participants or Reachable Parties, taking on a subset or the whole set of functionalities that are available to the Participant or Reachable Party granted them in terms of access rights. Participants and Reachable Parties can act as Instructing Parties as well.

Each legal entity may play different roles in TIPS. Generally speaking, any legal entity playing multiple business roles in TIPS results in the definition of multiple parties.

For example, a Central Bank willing to make use of TIPS also for the settlement of Instant Payments, needs to be defined as two parties, one Central Bank party and one TIPS Participant party.

Similarly, a financial institution holding two accounts within the books of two different Central Banks, would be defined as two different Participant parties, each of them belonging to one of the two Central Banks.

1.3.1.3. Hierarchical party model

The party model of TIPS is based on a hierarchical three-level structure. The TIPS Operator is the only party on the top level of the hierarchy and it is responsible for the setup of each party of the second level, i.e. each Central Bank in TIPS. Similarly, each party belonging to the second level (i.e. a Central Bank) is responsible for the setup of all parties of its community (i.e. Participants, Ancillary Systems and Reachable Parties), represented by parties of the third level. Instructing Parties are not part of the hierarchical party model, because as described in the previous section, they are not a type of party in TIPS, but rather a role that allows an Actor (a TIPS Participant, a Reachable Party or a third party not participating in TIPS) to instruct for a given party in TIPS.

The hierarchical model also determines the so-called reference data scope, i.e. the area of responsibility of each Central Bank and of the TIPS Operator. More into detail:

- The reference data scope of a Central Bank includes its reference data, plus the reference data of all its parties;
- The reference data scope of the TIPS Operator includes all the remaining reference data, i.e. all the reference data not included in the data scope of any Central Bank (e.g. countries and currencies reference data).

Each Central Bank and the TIPS Operator are responsible for their own reference data scopes, i.e. each of them is responsible for the input and maintenance of all information included in its reference data scope. The TIPS Operator may also act, upon request, on the reference data scope of a Central Bank.

1.3.1.4. Party identification

Each legal entity is identified in the financial market by a BIC (Business Identifier Code), according to the ISO 9362 standard. As previously described, each legal entity or organisation may result in the

definition of multiple parties in the Common Reference Data Management repository. This implies that the usage of BIC is not enough to ensure uniqueness in the identification of parties, as these parties may be related to the same legal entity and, consequently, they may have been assigned the same BIC. For this reason, the CRDM component requires two BICs to identify each party. More precisely, the CRDM service identifies each party with the BIC of the party itself and the BIC of the party with which it has established a business relation. Therefore:

- Each Participant, Ancillary System and Reachable Party is identified by the 11-character BIC of its Central Bank plus its own 11-character BIC;
- Each Central Bank is identified by the 11-character BIC of the TIPS Operator plus its own 11-character BIC.

TIPS imposes a constraint in the assignment of BICs related to its parties, due to the fact that the settlement process must be able to infer the accounts to be debited and credited by an Instant Payment transaction based on the BICs of the Originator Participant and of the Beneficiary Participant (see also section [2.2](#)). This circumstance implies the need to ensure that any given BIC can only be assigned to one TIPS party and that two different TIPS parties must have assigned two different BICs. For this reason, the CRDM component prevents allowing two different parties to be defined as TIPS parties if they are identified by the same 11-character BIC (this may happen, for example, when one financial institution is defined two times as a party by two different Central Banks). Therefore, in order to allow a given financial institution to be defined as two different TIPS parties (by the same Central Bank or by two different Central Banks), the same financial institution must be defined in the CRDM repository as two parties identified by two different 11-character BICs.

1.3.1.5. Reference data for parties in TIPS

The following diagram shows the conceptual data model for party reference data in TIPS. All related entities, attributes and relationships between different entities are described in detail in the rest of this section.

Figure 3 – Party reference data model

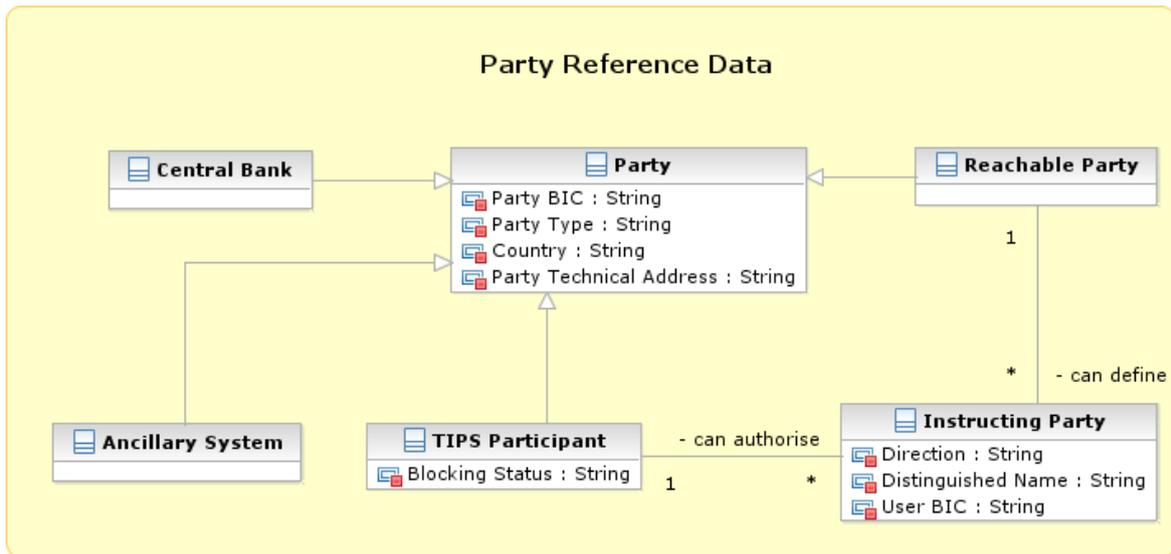

The following table shows the exhaustive list of Party reference data attributes that TIPS receives from the Common Reference Data Management component and stores in its Local Reference Data Management (LRDM) repository.

Table 3 – Party reference data

| Attribute | Description |
|-------------------------|--|
| Party BIC | 11-character Business Identifier Code (BIC11) to uniquely identify the party in TIPS. |
| Party Type | Type of party. The exhaustive list of party types is as follows: <ul style="list-style-type: none"> • TIPS Operator • Central Bank • Participant • Ancillary System • Reachable Party |
| Country | Country code of the Central Bank the party belongs to. |
| Party Technical Address | Distinguished Names defined for the receipt of messages relevant for the Party as account owner, such as reports and floor/ceiling notifications. |

| Attribute | Description |
|-----------------|--|
| Blocking Status | <p>Blocking status for the Party, only relevant for TIPS Participants.</p> <p>Exhaustive list of possible values:</p> <ul style="list-style-type: none"> - Blocked for credit; - Blocked for debit; - Blocked for credit and debit; - Unblocked. |

All other party reference data are stored in the Common Reference Data Management repository, as they are not needed for settlement in TIPS.

Each Participant party is linked to one or many TIPS Accounts (see section [1.3.2.1](#)), as account owner. An Ancillary System is linked to one TIPS AS Technical Account (see section [1.3.2.2](#)) as account owner. Each Central Bank party may be linked to one and only one Transit Account (see section [1.3.2.3](#)), as account owner of the Transit Account for a given currency.

The following table shows the exhaustive list of Instructing Party reference data attributes that TIPS receives from the Common Reference Data Management component and stores in its Local Reference Data Management repository.

Table 4 – Instructing Party reference data

| Attribute | Description |
|--------------------|---|
| Direction | <p>It specifies whether the link between the DN and the BIC authorises the Instructing Party to act as Originator Participant (inbound routing) or as Beneficiary Participant (outbound routing). The exhaustive list of possible values is as follows:</p> <ul style="list-style-type: none"> • Inbound • Outbound |
| Distinguished Name | <p>When Direction is “Inbound”, it specifies the DN the Instructing Party uses to send messages to TIPS. When Direction is “Outbound”, it specifies the DN TIPS uses to send messages to the Instructing Party.</p> |
| User BIC | <p>This field is only relevant for cases where a DN is acting on behalf of a specific BIC, such as in instant payments. When Direction is “Inbound”, it specifies the BIC the Instructing Party uses as Originator in the payment messages sent to TIPS. When Direction is “Outbound”, it specifies the BIC TIPS uses in the payment messages sent to the Instructing Party as Beneficiary.</p> |

For inbound routing purpose, one Distinguished Name may be linked to many Parties and, optionally, many Originator BICs, which means the same entity may play the Instructing Party role for many

Participants and Reachable Parties, possibly for many Originator BICs within the same Participant or Reachable Party. Conversely, one Party may be linked to many Distinguished Names, potentially specifying many Originator BICs, which means one Participant or Reachable Party may authorise many entities to play the Instructing Party role, for one or many of their BICs. Such a scenario may be used in case a TIPS Participant needs to instruct its own accounts and, at the same time, give a third party the possibility to instruct on its behalf on the same accounts.

For outbound routing purpose, any given Beneficiary BIC may be linked to one and only one Distinguished Name, which means each Participant and Reachable Party must authorise one and only one entity to play the Instructing Party role on the Beneficiary side. Conversely, one Distinguished Name may be linked to many Beneficiary BICs, which means one entity may play the Instructing Party role for many Participants and Reachable Parties.

The relationships between DNs and Originator/Beneficiary BICs are defined in the DN-BIC Routing table within CRDM. One Instructing Party may act both as Originator and Beneficiary, possibly using the same Distinguished Name for both directions (Inbound and Outbound).

1.3.2. Accounts structure and organisation

Accounts are opened in TIPS for the provision of liquidity and the settlement of Instant Payment transactions. The following diagram shows the conceptual data model for account reference data in TIPS. This section provides a detailed description of all the reference data CRDM stores and TIPS uses for all its accounts.

Figure 4 – Account structure and organisation

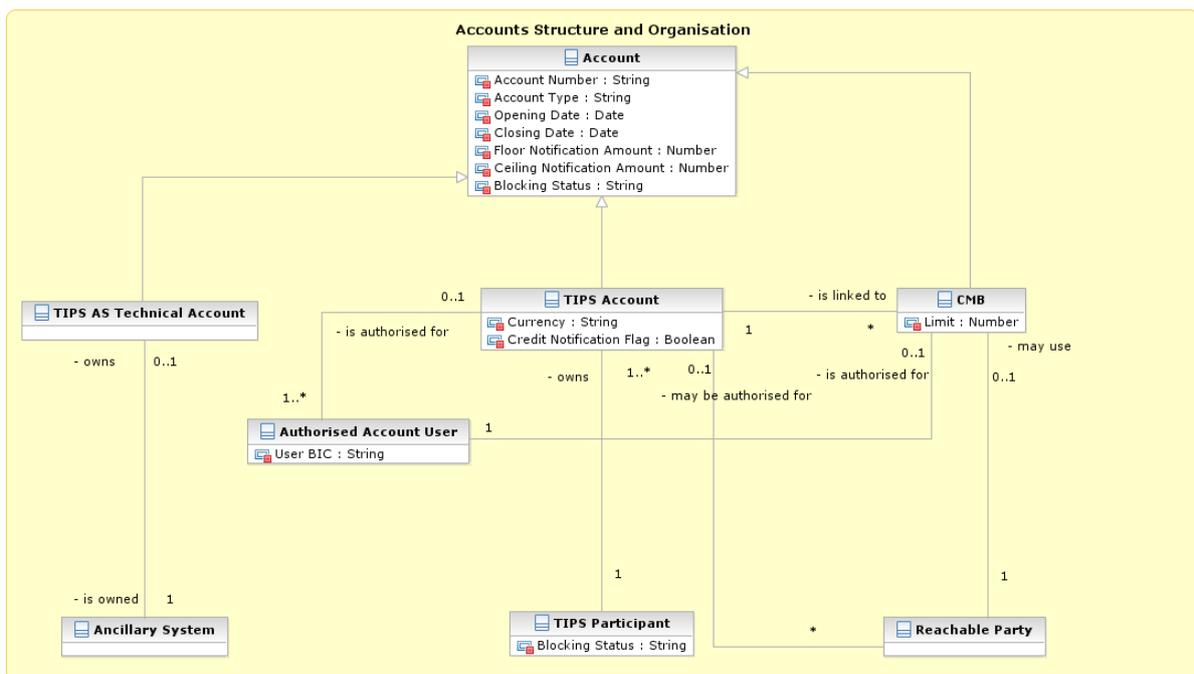

The TIPS Operator and Central Banks input and maintain in the Common Reference Data Management repository the following categories of accounts, depending on their role:

- TIPS Account
- TIPS AS Technical Account
- Transit Account

Furthermore, TIPS Participants may define Credit Memorandum Balances (CMBs) linked to their TIPS Accounts, in order to define payment capacity limits for their Reachable Parties. Similarly, Ancillary Systems may define CMBs linked to their AS Technical Accounts.

The following four sections define the above-mentioned reference data objects, whereas section [1.3.2.5](#) provides a detailed description of the reference data required by TIPS for the same reference data objects.

1.3.2.1. TIPS Accounts

TIPS Accounts are accounts that Participants use for the settlement of Instant Payments and Liquidity Transfers. They cannot have a negative balance.

Each Participant may own one or many TIPS Accounts and they may use them for their settlement activities or to give the possibility to settle to Reachable Parties or other Participants as well as authorising several BICs to use the account for settlement. The Participant that holds the TIPS Account, in any case, remains the owner and legal responsible for the TIPS Account itself.

Central Banks create TIPS Accounts for their Participants.

1.3.2.2. TIPS AS Technical Accounts

Ancillary Systems use TIPS AS Technical Accounts for Instant Payments, positive Recall Responses and Liquidity Transfers settlement. The account cannot have a negative balance.

Each Ancillary System may own at most one TIPS AS Technical Account to give to their Reachable Parties or Participants the permission to settle on it by authorising their BICs to use the account for settlement. Each Ancillary System that holds a TIPS AS Technical Account remains, in any case, the owner and legally responsible for it.

Central Banks open TIPS AS Technical Accounts for their Ancillary Systems.

1.3.2.3. Transit Accounts

Transit Accounts in TIPS are accounts that belong to Central Banks which may have either zero or negative balance as they reflect any movement of liquidity from/to the RTGS System. The transit accounts are technical accounts involved in the liquidity transfer process. They cannot be involved in the settlement of Instant Payment transactions. Only one Transit Account per settlement currency can exist in TIPS. The Transit Account for euro belongs to the European Central Bank. The TIPS Operator creates Transit Accounts for the Central Banks.

1.3.2.4. Credit Memorandum Balance

A Credit Memorandum Balance (CMB) represents a limit, e.g. defined for a Reachable Party, in the usage of the liquidity of a given TIPS Account or TIPS AS Technical Account. As such, each CMB is linked to exactly one TIPS Account, but each TIPS Account may have any number of CMBs, each CMB representing a credit line for a Reachable Party in TIPS. The same logic applies to CMBs linked to TIPS AS Technical Accounts.

On optional basis (i) TIPS Participants can create CMBs for their TIPS Accounts and (ii) Ancillary Systems can create CMBs for their TIPS AS Technical Account.

CMBs offer the possibility to define limit management flexibly on a TIPS Account, without dedicating liquidity exclusively for each single customer. Specifically, the sum of all CMB limits on a TIPS Account may be higher than the balance of the same Account at any time.

When defining a CMB, it is possible to specify a limit, which may be initially set to zero. In this case, the related user cannot make use of the payment capacity of the TIPS Account linked to the CMB until either (i) the limit is set by the TIPS Participant to a value greater than zero or (ii) the CMB starts receiving Instant Payments in credit. In order to propagate the CMB data to TIPS (if the CMB has been created) it is compulsory to define a Limit.

Additionally, the TIPS Participant (or the Ancillary System) may create an unlimited⁹ CMB. In this case, the related authorised account user can make use of the full payment capacity of the TIPS Account (or the TIPS AS Technical Account) linked to the CMB.

1.3.2.5. Reference data for accounts and CMBs in TIPS

The following table shows the exhaustive list of Account reference data attributes that TIPS receives from the Common Reference Data Management component and stores in its Local Reference Data Management repository.

Table 5 – Account reference data

| Attribute | Description |
|----------------|---|
| Account Number | It specifies the unique number of the account. |
| Account Type | Type of account. The exhaustive list of account types is as follows: <ul style="list-style-type: none"> • TIPS Account • TIPS AS Technical Account • Transit Account |
| Currency | It specifies the currency of the account. |
| Opening Date | Opening date of the account. |
| Closing Date | Closing date of the account. |

⁹ An unlimited CMB is defined by using the limit value 9999999999999999 in the camt.011

| Attribute | Description |
|-----------------------------|---|
| Floor Notification Amount | It specifies the lower threshold for notifying the account owner. When equal to zero, the notification is not produced. |
| Ceiling Notification Amount | It specifies the upper threshold for notifying the account owner. When equal to zero, the notification is not produced. |
| Credit Notification Flag | Boolean attribute specifying whether the account owner must receive a credit notification after the settlement of any inbound Liquidity Transfer from the relevant RTGS System. |
| Debit Notification Flag | Boolean attribute specifying whether the account owner must receive a debit notification after the settlement of any Outbound Liquidity Transfer to the relevant RTGS System. |
| Blocking Status | Blocking status for the account. Exhaustive list of possible values: <ul style="list-style-type: none"> - Blocked for credit; - Blocked for debit; - Blocked for credit and debit; - Unblocked. |

All other account reference data are stored in the Common Reference Data Management repository, as they are not needed for settlement in TIPS.

In terms of account ownership, the following rules apply:

- Each TIPS Account is linked to one TIPS Participant;
- Each TIPS AS Technical Account is linked to one Ancillary System;
- Each Transit Account is linked to one Central Bank (the European Central Bank for the euro Transit Account, the relevant Central Bank for any other settlement currency).

After the closing date is exceeded, a TIPS Account or a TIPS AS Technical Account is removed from the Local Reference Data Management database only if its balance is equal to zero. Otherwise, only the responsible Central Bank (and the Operator, upon request, in contingency) is authorised to instruct Outbound Liquidity Transfers on the closed account to repatriate the liquidity to the relevant RTGS System.

Furthermore, each TIPS Account or TIPS AS Technical Account may be linked to one or many CMBs and to one or many Authorised Account Users (see [Table 7](#) below).

The following table shows the exhaustive list of CMB reference data attributes that TIPS receives from the Common Reference Data Management component and stores in its Local Reference Data Management repository.

Table 6 – CMB reference data

| Attribute | Description |
|-----------------------------|---|
| CMB Number | It specifies the unique number of the CMB. |
| Opening Date | Opening date of the CMB. |
| Closing Date | Closing date of the CMB. |
| Floor Notification Amount | It specifies the lower threshold of the CMB headroom (see section 1.4) for notifying the owner of the account which the CMB is linked to. When equal to zero, the notification is not produced. |
| Ceiling Notification Amount | It specifies the upper threshold of the CMB headroom for notifying the owner of the account which the CMB is linked to. When equal to zero, the notification is not produced. |
| Limit | It specifies the limit amount for the CMB. |
| Blocking Status | Blocking status for the CMB. Exhaustive list of possible values: <ul style="list-style-type: none"> - Blocked for credit; - Blocked for debit; - Blocked for credit and debit; - Unblocked. |

All other CMB reference data are stored in the Common Reference Data Management repository, as they are not needed for settlement in TIPS.

Each CMB is linked to either one TIPS Account or one TIPS AS Technical Account.

The following table shows the exhaustive list of Authorised Account User reference data attributes that TIPS receives from the Common Reference Data Management component and stores in its Local Reference Data Management repository. Each Authorised Account User specifies a BIC which is allowed to use the related TIPS Account, TIPS AS Technical Account or CMB for settlement.

The BIC of an Ancillary System cannot be authorised to settle on a TIPS Account nor on a TIPS AS Technical Account.

Table 7 – Authorised Account User reference data

| Attribute | Description |
|-----------|--|
| User BIC | BIC authorised for settling on the account or CMB. |

All other Authorised Account User reference data are stored in the Common Reference Data Management repository, as they are not needed for settlement in TIPS.

Each Authorised Account User can be linked to one and only one TIPS Account, TIPS AS Technical Account or CMB; each CMB can have no more than one Authorised Account User, while TIPS Accounts and TIPS AS Technical Accounts may have any number.

1.4. Dynamic data model

This section describes the dynamic data model of TIPS. It contains all the data concerning settlement-related messages (i.e. Instant Payment transactions and Liquidity Transfers), such as transaction data, account balances and CMB headrooms. Furthermore, it also includes dynamic data related to local reference data objects, e.g. the blocking status of parties, accounts and CMBs, limit values. Finally, it also encompasses dynamic data concerning the different RTGS Systems connected to TIPS (e.g. current status and business date).

Figure 5 – Dynamic data model

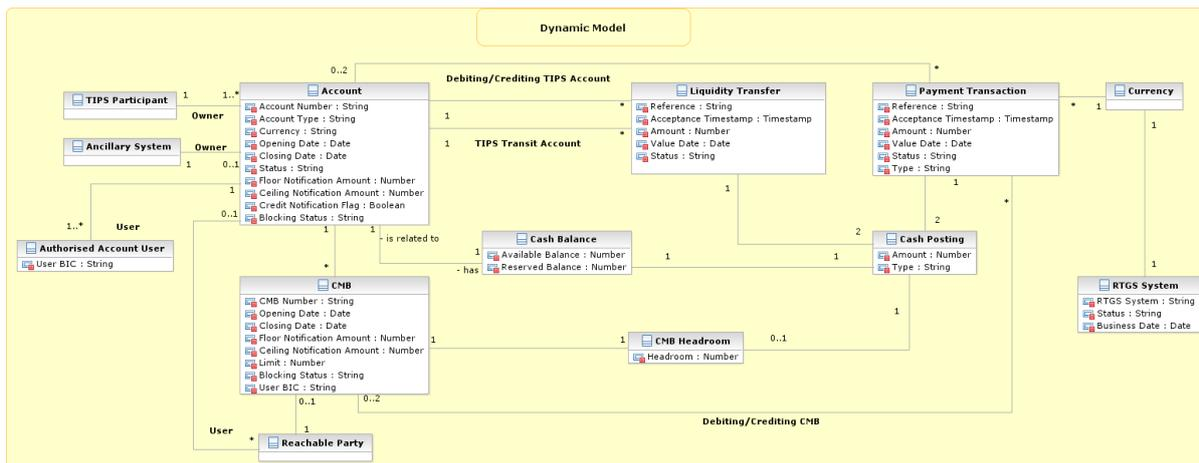

1.4.1. Payment Transaction

This entity represents data related to TIPS Instant Payment transactions following the SCT^{Inst} scheme, non-Euro denominated transactions or Single Instructing Party (SIP) settlement model processing.

Table 8 – Payment Transaction data

| Attribute | Description |
|----------------------|--|
| Reference | The Originator PSP's reference number of the SCT ^{Inst} Transaction message, non-Euro Transaction or SIP Transaction message. |
| Acceptance Timestamp | Timestamp of the SCT ^{Inst} Transaction, non-Euro Transaction or SIP Transaction message. |
| Amount | Amount intended to be settled by the transaction |
| Currency | The currency relevant for the transaction |

| Attribute | Description |
|--------------------------|--|
| Crediting Account | TIPS Account (or TIPS AS Technical Account) to be credited |
| Crediting Account Status | Blocking status for the TIPS Account (or TIPS AS Technical Account) to be credited. Exhaustive list of possible values: <ul style="list-style-type: none"> - Blocked for credit; - Blocked for debit; - Blocked for credit and debit; - Unblocked. |
| Crediting CMB | CMB to be credited |
| Crediting CMB Status | Blocking status for the CMB to be credited. Exhaustive list of possible values: <ul style="list-style-type: none"> - Blocked for credit; - Blocked for debit; - Blocked for credit and debit; - Unblocked |
| Debiting Account | TIPS Account (or TIPS AS Technical Account) to be debited. |
| Debiting Account Status | Blocking status for the TIPS Account (or TIPS AS Technical Account) to be debited. Exhaustive list of possible values: <ul style="list-style-type: none"> - Blocked for credit; - Blocked for debit; - Blocked for credit and debit; - Unblocked. |
| Debiting CMB | CMB to be debited. |
| Debiting CMB Status | Blocking status for the CMB to be debited. Exhaustive list of possible values: <ul style="list-style-type: none"> - Blocked for credit; - Blocked for debit; - Blocked for credit and debit; - Unblocked. |

| Attribute | Description |
|------------|--|
| Status | <p>Status of the transaction for both SCT^{Inst} and non-Euro settlement schemes.</p> <p>Exhaustive list of possible values:</p> <ul style="list-style-type: none"> - Received - Validated - Reserved - Settled - Failed - Rejected - Expired <p>For the SIP settlement model the exhaustive list of possible status values is the following:</p> <ul style="list-style-type: none"> - Received - Validated - Settled - Failed - Expired |
| Type | <p>Type of the underlying payment transaction.</p> <p>Exhaustive list of possible values:</p> <ul style="list-style-type: none"> - Instant Payment - Positive Recall Response |
| Value Date | Transaction settlement date in accordance to the related RTGS System. |

Each Instant Payment transaction creates two Cash Postings related to the impacted Accounts or CMBs.

1.4.2. Liquidity Transfer

This entity represents data related to liquidity transfers submitted by TIPS Actors or received from the relevant RTGS System. Liquidity Transfer data includes the following attributes.

Table 9 – Liquidity Transfer data

| Attribute | Description |
|----------------------|---|
| Reference | Reference number of the liquidity transfer. |
| Acceptance Timestamp | Timestamp assigned to the liquidity transfer when received by TIPS. |
| Amount | Amount intended to be transferred. |
| Currency | The currency relevant for the liquidity transfer. |

| Attribute | Description |
|--------------------------|--|
| Crediting Account | TIPS Account, TIPS AS Technical Account, or RTGS System Account to be credited. |
| Crediting Account Status | Blocking status for (i) the TIPS Account to be credited for an inbound liquidity transfer or (ii) TIPS AS Technical Account for an intra-service liquidity transfer. Exhaustive list of possible values: <ul style="list-style-type: none"> - Blocked for credit; - Blocked for debit; - Blocked for credit and debit; - Unblocked. |
| Debiting Account | TIPS Account, TIPS AS Technical Account or RTGS System Account to be debited. |
| Debiting Account Status | Blocking status for (i) the TIPS Account to be debited for an outbound liquidity transfer or (ii) TIPS AS Technical Account for an intra-service liquidity transfer. Exhaustive list of possible values: <ul style="list-style-type: none"> - Blocked for credit; - Blocked for debit; - Blocked for credit and debit; - Unblocked. |
| Status | Status of the liquidity transfer. Exhaustive list of possible values: <ul style="list-style-type: none"> - Received - Validated - Settled - Failed - Rejected by RTGS - Transient |
| Value Date | Liquidity transfer settlement date in accordance to the related RTGS System. |

Each Liquidity Transfer references a credited and a debited Account.

1.4.3. Cash Posting

Cash Postings are created for each Payment transaction or Liquidity Transfer that results in a reserved or settled amount on either a TIPS Account or a TIPS AS Technical Account. Cash Posting data includes the following attributes.

Table 10 – Cash Posting data

| Attribute | Description |
|-----------|--|
| Amount | Amount reserved or settled by the transaction or liquidity transfer. |

| | |
|------|---|
| Type | <p>Specifies the origin of the Cash Posting.</p> <p>Exhaustive list of possible values:</p> <ul style="list-style-type: none"> - Payment transaction - Liquidity Transfer |
|------|---|

Each Cash Posting is linked to a single Payment transaction or Liquidity Transfer, as well as a single Cash Balance. In addition, a Cash Posting can reference up to one CMB.

1.4.4. Cash Balance

A Cash Balance is created for each TIPS Account and modified each time a Payment Transaction or Liquidity Transfer results in a reserved or settled amount. Cash Balance data includes the following attributes.

Table 11 – Cash Balance data

| Attribute | Description |
|-------------------|---|
| Available Balance | Current balance available for settlement on the TIPS Account (or TIPS AS Technical Account) |
| Reserved Balance | Balance that has been temporarily reserved on the TIPS Account (or on the TIPS AS Technical Account) while the related Instant Payment transactions are executed. |

Each Cash Balance is linked to a single TIPS Account (or TIPS AS Technical Account) as well as a single Cash Posting.

1.4.5. CMB Headroom

TIPS keeps track of the utilisation and available headroom for each CMB for which a limit is defined. Whenever an Instant Payment transaction is settled against a given Originator or Beneficiary CMB, TIPS debits/credits the linked TIPS Account, or the TIPS AS Technical Account, and decreases/increases the relevant CMB Headroom accordingly at the same time. If the amount of an Instant Payment transaction would exceed the current CMB Headroom to be debited, then it is rejected.

For unlimited CMBs, the headroom must always be considered infinite and, conversely, the utilisation always zero.

A CMB Headroom is created for each CMB and modified each time an Instant Payment transaction impacting the CMB is processed or the CMB limit is adjusted. CMB Headroom data includes the following attributes:

Table 12 – CMB Headroom data

| Attribute | Description |
|--------------|---|
| CMB Headroom | Current value of the limit available for settlement on the related CMB. |

Each CMB Headroom is linked to a single CMB as well as a single Cash Posting.

1.4.6. RTGS Systems

TIPS maintains information about the RTGS Systems that interact with it, along with the respective currency, status (i.e. whether they are open and ready to receive liquidity transfers or not), distinguished name and business date. The distinguished name of the RTGS System is recognised as a dedicated RTGS System user authorised to send any messages or queries to TIPS (e.g. to manage the transfer of liquidity from the RTGS System to TIPS and to query the balances of the TIPS Accounts linked to the RTGS System account).

As for the RTGS status field, besides the values (i) *Open* where any authorised participant can inject inter-service liquidity transfers and (ii) *Closed* where nobody can inject inter-service liquidity transfers, the status (iii) *Partially Closed* is used to authorize only the Central Bank(s) to instruct inter-service LTs.

Similarly to status *Open* and *Closed*, also the *Partially Closed* is activated per currency. Currently, its activation is only foreseen for the Danish community in the time slot between 17:00 and 18:00 of the RTGS business date for the DKK. During the partial closure window for a currency, TIPS rejects any outbound inter-service LT attempt in that currency from a non-Central Bank user whereas any inbound inter-service LT attempt can only be blocked in the connected RTGS system.

It is worth specifying that Intra-service Liquidity transfers are not impacted by the above-mentioned *Partially Closed* status as they can be processed in TIPS on a 24/7 basis, without limitations.

The status and the business date are updated automatically upon receiving a [ReturnBusinessDayInformation](#) message from the relevant RTGS System and can be modified manually by the TIPS Operator in contingency situations. RTGS System data includes the following attributes.

Table 13 – RTGS Systems data

| Attribute | Description |
|---------------|--|
| RTGS System | Identifier of the RTGS System interacting with TIPS. |
| RTGS Currency | Settlement currency of the related RTGS System. |

| | |
|--------------------|--|
| RTGS Status | Current status of the related RTGS System. Possible values: - Open - Closed - Partially Closed |
| Business Date | Current business date of the RTGS System. |
| Distinguished Name | DN of the RTGS System |

The following RTGS status transitions are therefore allowed, taking into consideration the example of DKK currency:

- From '*Open*' to '*Closed*': Any Inter-service Outbound Liquidity Transfer is rejected by TIPS, regardless of the sender.
- From '*Closed*' to '*Partially Closed*': Inter-service Outbound Liquidity Transfers are rejected by TIPS if a sender does not belong to the Central Bank operating on the specific currency for which partial closure applies.
- From '*Partially Closed*' to '*Closed*': Any Inter-service Outbound Liquidity Transfer is rejected by TIPS, regardless of the sender.
- From '*Closed*' to '*Open*': Any Inter-service Outbound Liquidity Transfer is accepted by TIPS, regardless of the sender.

1.5. TIPS Features

1.5.1. General concepts

TIPS processes instructions continuously during the day, on a 24/7/365 basis without any scheduled service downtime. In this context, the term “instructions” refers not only to Instant Payments or Liquidity Transfers, but also to local reference data updates and any other type of request that leads to the update of reference or dynamic data in TIPS.

All these types of instructions are processed in a strictly ordered sequence as part of the same input flow, so that a single sequence of instructions leads deterministically to a single possible status.

For example, TIPS may receive an Instant Payment transaction that attempts to debit an account and a concurrent request to block the same account for debiting. If TIPS receives the ordered sequence where the debiting precedes the blocking, the Instant Payment transaction will be processed before the account is blocked. If, conversely, TIPS receives the ordered sequence where the account blocking is executed prior to the Instant Payment transaction, the account will be blocked whereas the transaction will be rejected.

The possible types of instructions processed by TIPS are listed below:

- Instant Payment transactions for the settlement of cash on a TIPS Account/TIPS AS Technical Account
- Beneficiary replies to confirm or reject an Instant Payment transaction on the beneficiary side
- Recall instructions to request a refund from the Beneficiary Participant for previously settled Instant Payment transactions
- Recall Responses from the Beneficiary Participant - for either the refund or the rejection - in response to a recall instruction
- Investigation and Request for Status Update on a Recall
- Liquidity transfers to instruct the transfer of liquidity between TIPS and an RTGS System
- Intra-service Liquidity transfers between a TIPS Account and a TIPS AS Technical Account
- Reference data maintenance instructions to modify TIPS local reference data.

Local reference data maintenance within TIPS is limited to the following set of operations that can be performed at any point in time (i.e. 24/7/365) with immediate effect:

- Blocking/unblocking of a TIPS Participant or Ancillary System;
- Blocking/unblocking of an account or CMB;
- Update of a CMB limit.

All other reference data setup and maintenance operations are performed in CRDM; reference data are then propagated from CRDM to TIPS asynchronously, on a daily basis (as described in section [1.6.3](#)).

TIPS also offers querying and reporting functionalities.

Data included in reports depends on the access rights profile of the subscribing TIPS Actor and is based on periodical snapshots taken at specific points in time in TIPS. TIPS offers two types of reports:

- Statement of Account Turnover;
- Statement of Accounts.

TIPS Actors can subscribe for the types of reports they want to receive.

For the Statement of Accounts the TIPS Actors can also configure whether they want to receive it in full mode (complete set of data) or in delta mode (including only the data produced since the last generation of the same type of report for the same actor) along with the frequency they want to receive it at each day.

TIPS triggers the production of full reports when the relevant RTGS System notifies TIPS about the end of the current business day. In addition, delta reports can be scheduled to be produced and sent at regular intervals corresponding to the moments when snapshots are taken (every number of hours, e.g. every 3 hours, every 6 hours, etc.). When subscribing for a report in Delta mode, the end of the business day of the relevant RTGS System triggers in any case a last report generation for the business day which contains all the data remaining between the trigger itself and the last Delta report produced for the interested Actor.

In addition, upon notification from an RTGS System that a new business date has been reached, TIPS provides the same RTGS System with data on the business day that just elapsed and that the RTGS System uses to build and provide General Ledgers to the Central Banks.

Queries, with the exception of the Advanced Payment Transaction status query and the Advanced Liquidity Transfer status query which may be subject to a less restrictive service level agreement, are available on a 24/7/365 basis, and allow users to access data in real time. TIPS provides six types of queries:

- Account balance and status query;
- CMB limit and status query;
- Payment transaction status query;
- Advanced Payment transaction status query;
- Liquidity transfer status query;
- Advanced Liquidity transfer status query.

With the exception of the Advanced Payment transaction status query, the Liquidity transfer status query and the Advanced Liquidity transfer status query, which are available in U2A only, the remaining queries can be triggered both in U2A and A2A modes.

The following subsections go in depth on the aforementioned features.

1.5.2. Settlement of Instant Payment transactions

TIPS supports the different process flows foreseen in the SCT^{Inst} scheme, i.e. Instant Payments, recalls and investigations.

Moreover, TIPS supports two additional process flows for Instant Payment processing:

- Non-Euro settlement scheme;
- Single Instructing Party (SIP) settlement model.

The table below contains an overview of the types of instructions TIPS Actors can exchange with TIPS for payment purposes.

Table 14 – TIPS Payment transaction types

| Instruction Type | Description | Model/Flow |
|-----------------------------|--|--|
| Instant Payment transaction | Forwarded from an Originator Participant, Ancillary System or Instructing Party acting on behalf of the Originator Participant or a Reachable Party to TIPS to instruct the settlement of cash on a TIPS Account or on a TIPS AS Technical Account. It is also forwarded by TIPS to the intended Beneficiary Participant, Ancillary System or Instructing Party acting on behalf of the Beneficiary Participant or a Reachable Party to request confirmation for the settlement. | SCT ^{Inst} , non-Euro settlement scheme |

| Instruction Type | Description | Model/Flow |
|--|---|--|
| Instant Payment transaction without reservation (for SIP settlement model) | <p>Sent from an Originator Participant, Ancillary System or Instructing Party acting on behalf of the Originator Participant or a Reachable Party to TIPS to instruct the immediate settlement of cash on a TIPS Account or on a TIPS AS Technical Account., without preliminary reservation of funds.</p> <p>In order to activate such a settlement model, TIPS checks that (i) the DN acting on behalf of the Originator and the Beneficiary coincide and (ii) the same DN is granted with the appropriate privilege to Instruct as SIP¹⁰.</p> | SIP settlement model |
| Beneficiary Reply | <p>Forwarded from a Beneficiary Participant, Ancillary System or Instructing Party acting on behalf of the Beneficiary Participant or a Reachable Party to TIPS as response to an Instant Payment transaction. It contains the Beneficiary Participant's positive or negative response. In the event of a positive response, it is also forwarded by TIPS back to both (i) the Originator Participant, Ancillary System or Instructing Party acting on behalf of the Originator Participant or a Reachable Party and (ii) an additional confirmation is sent to the Beneficiary Participant, Ancillary System or Instructing Party acting on behalf of the Beneficiary Participant or a Reachable Party as confirmation that settlement has been performed or ended in error. In the event of a negative response, it is forwarded by TIPS back to the Originator Participant, Ancillary System or Instructing Party acting on behalf of the Originator Participant or a Reachable Party.</p> | SCT ^{Inst} , non-Euro settlement scheme |
| Recall | <p>Sent by an Originator Participant of a previously settled Instant Payment transaction to request that the given transaction is refunded and a refunded amount – equal or possibly lower than the original one – is credited back to the original account. It is submitted by the Originator Participant, Ancillary System or Instructing Party acting on behalf of the Originator Participant or a Reachable Party to TIPS and, after successful validation, it is forwarded by TIPS to the relevant Beneficiary Participant, Ancillary System or Instructing Party acting on behalf of the Beneficiary Participant or a Reachable Party.</p> | SCT ^{Inst} , non-Euro settlement scheme |

¹⁰ The privilege to 'Instruct as SIP' is independent from the TIPS privilege to 'Instruct instant Payments'. This means that the two privileges can coexist in the same access right profile of a TIPS Actor. However, if the same technical sender is willing to send IPs for both settlement models, i.e. instruct IP with reservation of funds and SIP, in a fully segregated way it shall use two different DNs.

| Instruction Type | Description | Model/Flow |
|---------------------------------------|---|--|
| Recall Response | Sent by a Beneficiary Participant, Ancillary System or Instructing Party acting on behalf of the Beneficiary Participant or a Reachable Party to TIPS as either a positive response to refund the cash, reversing the effect of the original Instant Payment transaction, or a negative response to a Recall instruction. In both cases, after successful validation, it is forwarded by TIPS to the Originator Participant, Ancillary System or Instructing Party acting on behalf of the Originator Participant or a Reachable Party as confirmation. | SCT ^{Inst} , non-Euro settlement scheme |
| Investigation | The investigation is sent by the Originator Participant, Ancillary System or Instructing Party acting on behalf of the Originator Participant or Reachable Party to TIPS in order to retrieve the last generated payment transaction status advice. | SCT ^{Inst} , non-Euro settlement scheme, SIP settlement model |
| Request for Status Update on a Recall | The Request for Status Update on a Recall is sent by Recall Assigner to TIPS in order to retrieve the status of the Recall Response. It is also forwarded by TIPS to the intended Recall Assignee to request confirmation about the status of the Recall. | SCT ^{Inst} , non-Euro settlement scheme |

1.5.2.1. Instant Payment transaction settlement process (with reservation of funds)

An Instant Payment transaction is initiated by an Originator Participant or Instructing Party acting on behalf of the Originator Participant, Ancillary System or a Reachable Party, e.g. a TIPS Participant, requesting to debit one of their accounts and to credit the account of a Beneficiary Participant. The perimeter of TIPS is limited to the interactions with these participants, which represent financial institutions or parties acting on their behalf. The communication between the actual Originator and Beneficiary of a payment (i.e. the individuals or institutions transferring funds between each other, which may be customers of the Originator/Beneficiary Participants) is out of the TIPS scope and handled by each participant independently.

In the following description, for the sake of readability, the expression “Originator side” means “the Originator Participant, Ancillary System or Instructing Party acting on behalf of the Originator Participant or a Reachable Party” and “Beneficiary side” means “Beneficiary Participant, Ancillary System or Instructing Party acting on behalf of the Beneficiary Participant or a Reachable Party”.

TIPS keeps track of the cash balance for each TIPS Account and TIPS AS Technical Account. The settlement process begins with an Instant Payment transaction message submitted by the Originator side to TIPS. TIPS validates the message and, if no errors are detected and sufficient funds are available, reserves the amount to be debited on the Originator side’s account by creating a related cash posting. TIPS thereafter forwards the Instant Payment transaction to the Beneficiary side. While the cash amount is reserved, it cannot be used for settlement in a different payment or liquidity transfer; in

addition, if either (i) the account owner or (ii) the account is blocked after the reservation and before the payment can be settled, the reserved amount is still eligible for settlement.

The Beneficiary side shall respond to TIPS with a beneficiary reply, either confirming or rejecting the payment. Upon receiving this reply, TIPS will respectively settle or release the reserved amount, removing the cash posting and updating the cash balances of the Originator and Beneficiary Participant accounts. Subsequently, TIPS will forward a status advice to both the Originator and Beneficiary sides. Payments are always settled for the full amount; partial settlement is not foreseen in TIPS.

If TIPS does not receive a reply from the Beneficiary Participant within a standard, configurable timeout period, the reserved amount is automatically released and can then be once again used for settlement. In the aforementioned scenario, TIPS sends a negative status report to both the Originator and Beneficiary sides and removes the relating cash posting.

Instant Payment transactions that involve CMBs are handled similarly to the above description. A CMB Headroom is created for each CMB in TIPS, and it is always kept equal to the CMB limit minus the current limit utilisation. A CMB can also be unlimited; in this case the related user can make use of the full payment capacity of the TIPS Account linked to the CMB, the headroom is considered infinite and the utilisation always zero.

When an Instant Payment transaction involving one or two CMBs with limit is settled, in addition to updating the cash balances for the involved accounts, the headroom and the limit utilisation of the related CMBs are also modified. For the unlimited CMBs, the headroom remains unlimited and the utilisation remains zero.

The limit of a CMB can never be set to a negative value, although the headroom and utilisation can go negative.

The utilisation can become negative when the headroom to exceed the limit as a result of crediting payments or liquidity transfers.

The headroom can become negative as a result of a CMB limit decrease, since when updating the limit the headroom and utilisation are updated accordingly. When the headroom becomes negative, the CMB only accepts instant payments and liquidity transfers in credit until the headroom goes above zero.

The following diagram shows the possible statuses of an Instant Payment transaction.

Figure 6 – Instant Payment Transaction status transition diagram

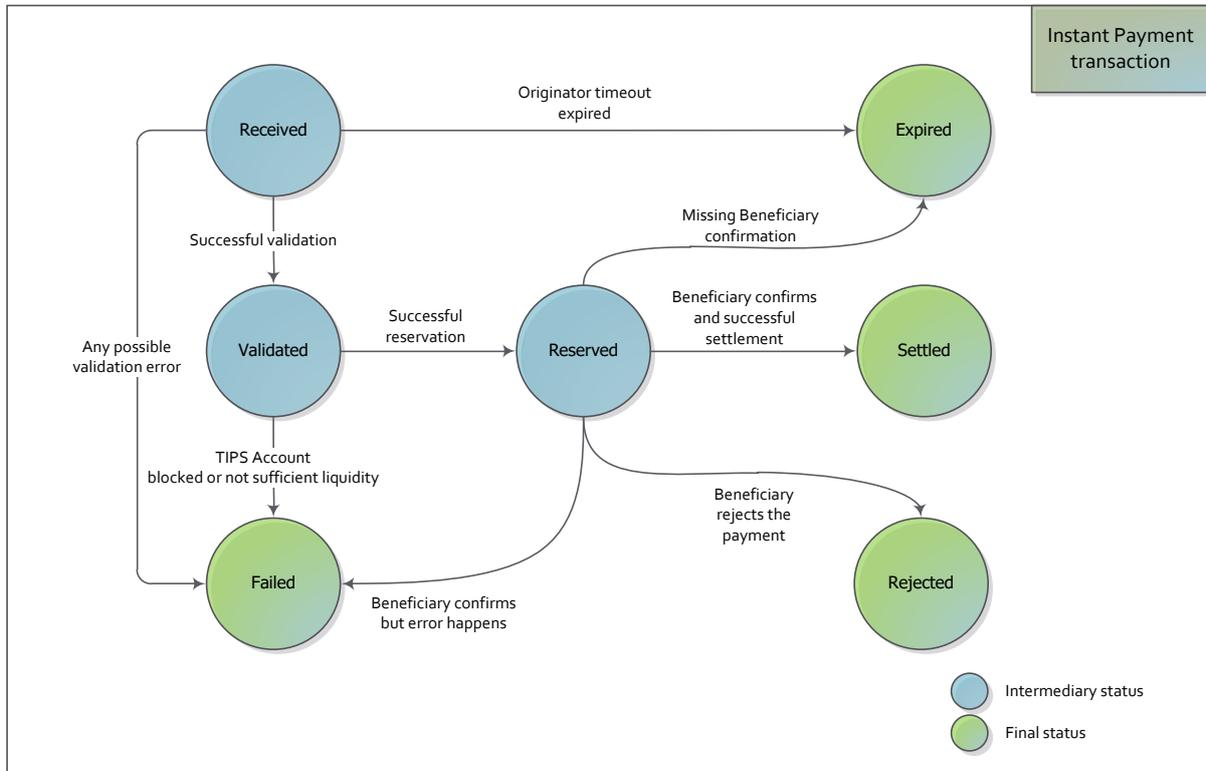

An Instant Payment transaction entering the system for the first time is temporarily in *Received* status while it undergoes the TIPS validations. While in this status, it is already possible for an Instant Payment transaction to exceed the timeout period, leading it to the final *Expired* status from which it will no longer be submitted to settlement. This can happen when TIPS receives a message from the Originator Participant, Ancillary System or Instructing Party that has an Acceptance Timestamp already older than the tolerable timeout; TIPS records the received message, replies with a timeout error message to the sender and saves the transaction as *Expired*.

If the Instant Payment transaction passes all validations successfully, it becomes *Validated*. At this point the actual settlement process begins with the attempt to reserve the required cash amount on the relevant debit account. If the reservation is successful, the transaction is set to *Reserved* status; if for any reason the reservation is unsuccessful (e.g. because either the cash balance on the account is insufficient or the account is blocked) its status changes to *Failed*.

A *Reserved* Instant Payment transaction may subsequently change its status into one of the four final statuses, depending on the outcome of the settlement attempt:

1. If TIPS does not receive the Beneficiary side reply within the standard timeout period, the Instant Payment times out and the transaction moves to status *Expired*;
2. If the Beneficiary side rejects the Instant Payment, the transaction moves to status *Rejected*;

3. If the Beneficiary side confirms or rejects the Instant Payment but any kind of error occurs, the transaction moves to status *Failed*;
4. Finally, if the Beneficiary side confirms the Instant Payment and TIPS settles it successfully, the transaction moves to status *Settled*.

The detailed flow of the process, with the relevant steps, is described (i) in section [2.2.1 – “Instant Payment \(SCT^{Inst} scheme\)”](#) and [Figure 19 – Instant Payment transaction flow](#) for Euro currency and (ii) in section [2.2.2 – “Instant Payment \(non-Euro currencies scheme\)”](#) and [Figure 60 – Instant Payment transaction flow for non-Euro currencies](#).

1.5.2.2. Instant Payment transaction settlement process (without reservation of funds)

An Instant Payment transaction for the SIP settlement model - without preliminary reservation of funds - can be used for the settlement of Instant Payment transactions. In principle, from a functional viewpoint, the model can be used regardless of the scheme and the currency denomination of the two accounts involved in the Instant Payment transaction. The transaction is initiated by an Originator Participant, Ancillary System or Instructing Party acting on behalf of the Originator Participant or a Reachable Party, e.g. a TIPS Participant, requesting to debit one of their TIPS Accounts and to credit the TIPS Account of a Beneficiary Participant.

In order to trigger the SIP settlement model, the Instructing Party that submits the Instant Payment has to be granted with a dedicated privilege in CRDM. Moreover, TIPS will check that the same DN is acting for both counterparties.

The SIP settlement model envisages the immediate settlement of Instant Payments received by TIPS, after the Instant Payments have already been validated by a Single Instructing Party (SIP), with the involvement of both the Originator PSP and the Beneficiary PSP (which accepts the transaction before it is submitted to TIPS).

The diagram in [Figure 7](#) shows the SIP settlement model, which is based on the following processing steps:

1. After having validated an instant payment with both PSPs, the Single Instructing Party sends it to TIPS for settlement.
2. Settlement attempt takes place in TIPS immediately, without preliminary reservation of funds.
3. The Single Instructing Party is notified about the outcome of the settlement attempt, so that the settlement confirmation can be forwarded to the Originator PSP and to the Beneficiary PSP.

Figure 7 – Single Instructing Party settlement model for Instant Payments

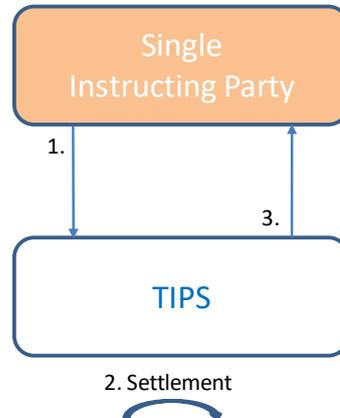

The SIP settlement process begins with an Instant Payment transaction message submitted by the Single Instructing Party to TIPS. TIPS checks whether the sender DN has the suitable access rights to trigger the SIP settlement model and validates the message. If the DN is granted with the correct access rights and no errors are detected, provided that sufficient funds are available on the account to be debited, TIPS settles the full amount by directly updating the cash balances of the Originator and Beneficiary Participant accounts. Subsequently, TIPS forwards a status advice to the Single Instructing Party DN. Instant payments are always settled for the full amount; partial settlement is not foreseen in TIPS.

Instant Payment transactions that involve CMBs are handled similarly to the above description. A CMB Headroom is created for each CMB in TIPS, and it is always kept equal to the CMB limit minus the current limit utilisation. A CMB can also be unlimited; in this case, the related user can make use of the full payment capacity of the TIPS Account linked to the CMB, the headroom is considered infinite and the utilisation always zero.

When an Instant Payment transaction involving one or two CMBs with limit is settled, in addition to updating the cash balances for the involved accounts, the headroom and the limit utilisation of the related CMBs are also modified. For the unlimited CMBs, the headroom remains unlimited and the utilisation remains zero.

The limit of a CMB can never be set to a negative value, although the headroom and utilisation can go negative.

The utilisation can become negative when the headroom to exceed the limit as a result of crediting payments or liquidity transfers.

The headroom can become negative as a result of a CMB limit decrease, since when updating the limit the headroom and utilisation are updated accordingly. When the headroom becomes negative, the CMB only accepts instant payments and liquidity transfers in credit until the headroom goes above zero.

The following diagram shows the possible statuses of an Instant Payment transaction in the scenario of a SIP settlement model.

Figure 8 – SIP Instant Payment Transaction status transition diagram

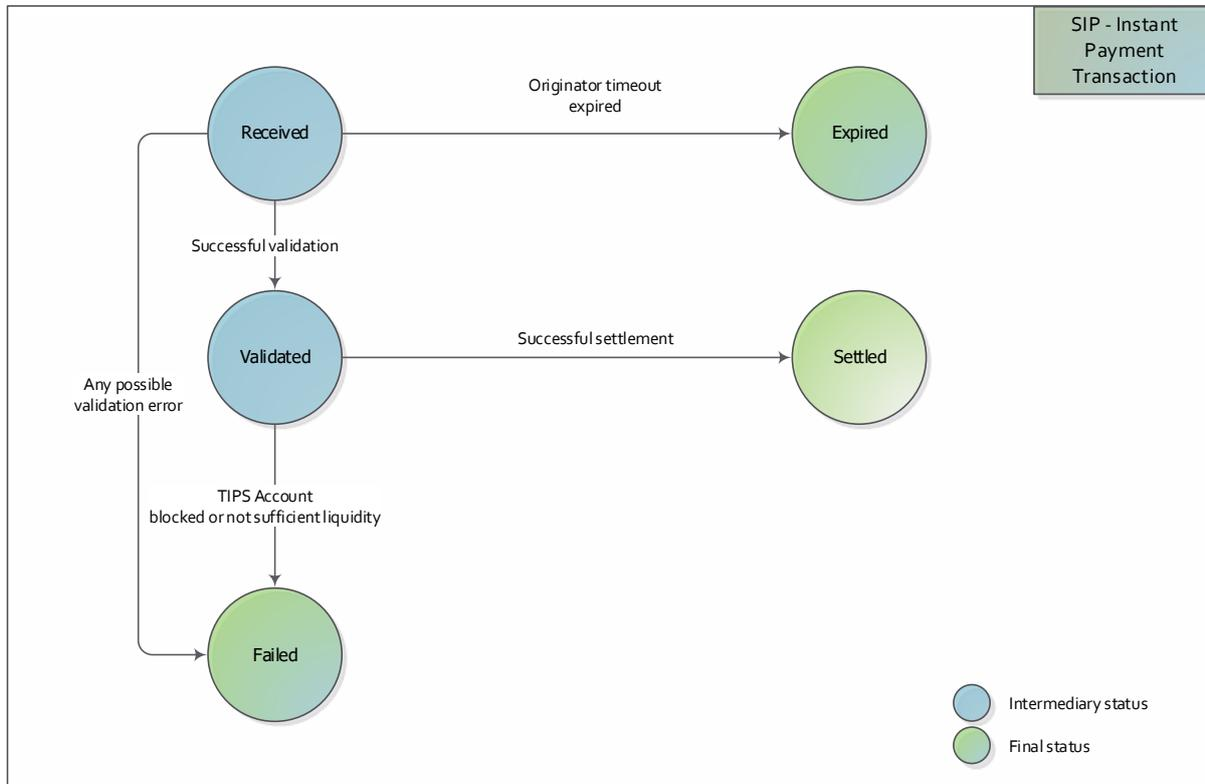

An Instant Payment transaction entering the system for the first time is temporarily in *Received* status while it undergoes the TIPS validations. While in this status, it is already possible for an Instant Payment transaction to exceed the timeout period, leading it to the final *Expired* status from which it will no longer be submitted to settlement. This can happen when TIPS receives a message from the Single Instructing Party that has an Acceptance Timestamp already older than the tolerable timeout; TIPS records the received message, replies with a timeout error message to the sender and saves the transaction as *Expired*.

If the Instant Payment transaction passes all validations successfully, it moves to status *Validated*. At this point, the actual settlement process begins with the attempt to settle the required cash amount on the relevant debit account. If the settlement is successful, the transaction is set to *Settled* status; if for any reason the settlement is unsuccessful (e.g. because the cash balance on the TIPS Account is insufficient or the account is blocked) its status changes to *Failed*.

The detailed flow of the SIP settlement model process, with the relevant steps, is described in section [2.2.3 - Instant Payment \(SIP settlement model\)](#) and [Figure 97 – Instant Payment transaction flow for SIP settlement model](#).

1.5.2.3. Recall settlement process

The Originator Participant, Ancillary System or Instructing Party of a previously settled Instant Payment transaction (the Recall Assigner) can send to TIPS a specific recall message in order to request the

return of funds previously settled. TIPS validates that the requestor is duly authorised to initiate the recall process and the Recall Assignee, which is the Beneficiary Participant of the original Instant Payment, can be reached via TIPS. No further validations are performed by TIPS which simply forwards the request to the intended recipient.

The Beneficiary Participant is authorised to send to TIPS a Recall Response containing either the acceptance or the rejection of the request. The sender can be also an Instructing Party acting on behalf of the Beneficiary Participant. There is no time limit enforced in TIPS for the receiver of the Recall (i.e. the Recall Assignee) to respond; TIPS does not perform any timeout check and it is up to the Participants or Instructing Parties to adhere to specific time rules pertaining to recalls.

Once the Recall Response is received, TIPS performs several checks using the most recent reference data; this means that changes done to the reference data affecting access rights may change the outcome of the authorisation check between processing of the recall and processing of the Recall Response.

In case the Recall Assignee replies with a negative Recall Response, if the checks are successful, the negative Recall Response is immediately forwarded by TIPS to the Recall Assigner.

In case the Recall Assignee replies with a positive Recall Response, additional processing has to be performed by TIPS. The system determines from the Originator Participant or Reachable party BIC and Beneficiary Participant or Reachable party BIC within the positive Recall Response message the accounts and CMBs that TIPS has to use for settlement of the recall. In order to reverse the direction of the cash flow from the original payment transaction that is recalled, TIPS interprets the Originator Participant or Reachable Party BIC as the Beneficiary participant or Reachable party BIC for the reversed cash flow, and vice versa.

Once the above data are retrieved, TIPS determines a suitable payment transaction dataset and immediately attempts to settle the reversed cash flow using the same or a different amount (the Recall Assignee may apply a fee for recalls). The payment process stated for the settlement of an Instant Payment transaction is for the most part applied also for payment transactions automatically generated by TIPS during the processing of a positive Recall Response. The latter differs from processing an Instant Payment transaction only because there is no reservation of funds and their acceptance is implicitly assumed by issuing the recall in the first place.

If any check on either positive or negative Recall Response fails or the transaction cannot be settled, e.g. due to insufficient funds on the debited account, TIPS informs the sender of the Recall Response with a [FIToFIPaymentStatusReport](#).

The following figure shows the possible statuses of a positive Recall Response, whose content determines the dataset of the payment transaction that should be settled in TIPS. As mentioned above TIPS acts as a channel between the Assigner and the Assignee without storing any messages data or internal statuses related to each Recall, Request for Status Update on a Recall and negative Recall Response.

Figure 9 – Positive Recall Response status diagram

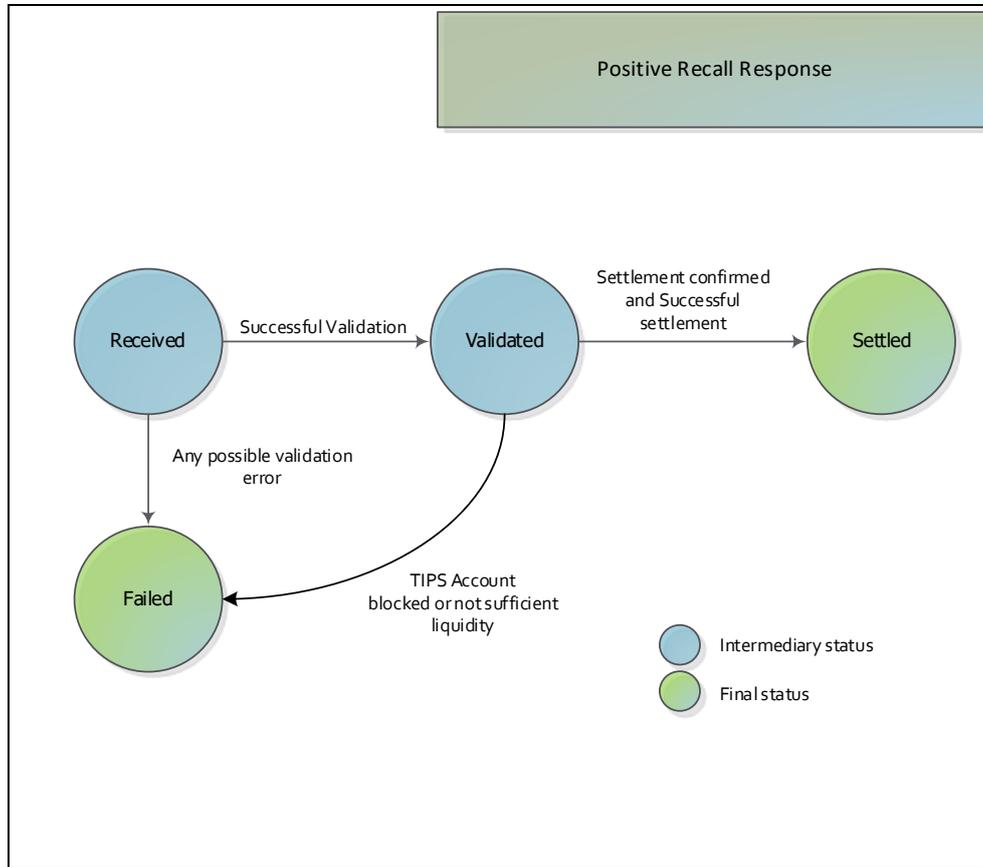

The positive Recall Response is *Received* once technical validation and authentication checks are executed; its status skips to *Validated* just after TIPS has performed successfully the required Access Rights and Duplicate check. If the checks are not successful the status of the Recall Response is set to *Failed*. Simultaneously TIPS sends a message to the Recall Assignee containing the proper error code. At this point the validated Recall Response is submitted for settlement with the attempt to reverse the cash flow on the relevant debit account. If the settlement attempt is successful, the instruction is set to *Settled* status; if for any reason the attempt is unsuccessful (e.g. because the cash balance on the account is insufficient or the account is blocked) the settlement fails and the status of the positive Recall Response changes to *Failed*.

1.5.2.4. Investigation process

As defined in the SCT^{inst} rulebook, the investigation procedure is foreseen for exceptional situations whereby no confirmation message has reached the Originator PSP after the time-out deadline.

In line with the SCT^{inst} scheme rulebook, TIPS supports a transaction status investigation process, which can be initiated only by Participants or Instructing Parties acting on behalf of Participants or Reachable Parties on the originator side using the transaction status inquiry message. This allows TIPS Actors to retrieve the last generated payment transaction status advice for either a single or a set of transactions

contained in the status request. If no payment transaction status advice is present, an error is returned for each transaction under investigation.

TIPS retains information for responding to investigations for a configurable timeframe, initially set to exactly 5 calendar days (see [Table 53](#)). Furthermore, according to the SCT^{Inst} scheme rulebook, the investigation functionality will be available only after the certainty of completion of the settlement phase of a transaction, which translates into [SCT^{Inst} Timestamp Timeout](#) expiration + [Investigation Offset](#).

The investigation functionality will be described in the section [2.4 “Investigation”](#).

1.5.3. Liquidity Management

TIPS provides liquidity management functionalities to allow the transfer of liquidity between TIPS Accounts and RTGS System Accounts, in both directions. Liquidity transfers can only be performed between accounts that are denominated in the same currency.

TIPS foresees three different types of Liquidity Transfer: Inbound (from an RTGS System to TIPS), Outbound (from TIPS to an RTGS System) and intra-service (from a TIPS Account to a TIPS AS Technical Account or vice versa). TIPS AS Technical Accounts cannot be used neither in Inbound nor Outbound Liquidity Transfer processing.

Inbound and outbound Liquidity Transfers are settled by moving the liquidity through an RTGS System Transit Account. TIPS has one and only one Transit Account defined for each currency. The Central Bank responsible for the RTGS System related to a given currency is the Central Bank accountable for the Transit Account. The ECB is responsible for the Transit Account denominated in euro whereas each non-Euro Central Bank is responsible for the Transit Account denominated in their currency.

Liquidity transfers do not entail a reservation of funds, unlike Instant Payment transactions, and are settled immediately.

Besides the cases described above, it shall also be possible for an authorised actor to move liquidity from TIPS to other TARGET Services or components (e.g. T2S¹¹) and vice versa. However, from a TIPS viewpoint these types of transfers will always be intermediated by the T2-CLM component.

1.5.3.1. Inbound Liquidity Transfer

An Inbound Liquidity Transfer moves liquidity from an RTGS System Account to a TIPS Account in the same currency. Inbound Liquidity Transfer orders can be triggered only in the RTGS System and are received by TIPS.

Authorised Account holders in the RTGS System may trigger Inbound Liquidity Transfer orders in the corresponding RTGS System; the order is received, as a Liquidity Transfer message, in TIPS. A TIPS Account to be credited must be specified in the message. Originators of Inbound Liquidity Transfer

¹¹ It is worth mentioning that no direct interface between TIPS and T2S is envisaged. Moreover, this option will be available only as of the T2-T2S Consolidation go-live, since the described functionality relies on the T2-CLM component.

orders do not necessarily need to be TIPS Actors. For instance, any entity who owns a PM account in TARGET2 may trigger Inbound Liquidity Transfers in euro, even if it does not own an account in TIPS. If the received message passes all the business checks successfully, TIPS transfers the requested amount from the relevant Transit Account to the TIPS Account. After settlement, TIPS informs the RTGS System and, optionally, the owner of the TIPS Account about the successful settlement.

Liquidity transfer orders can have different statuses depending on the executed steps of the settlement process. The possible statuses of an Inbound Liquidity Transfer order are described in the following diagram.

Figure 10 – Inbound Liquidity Transfer status diagram

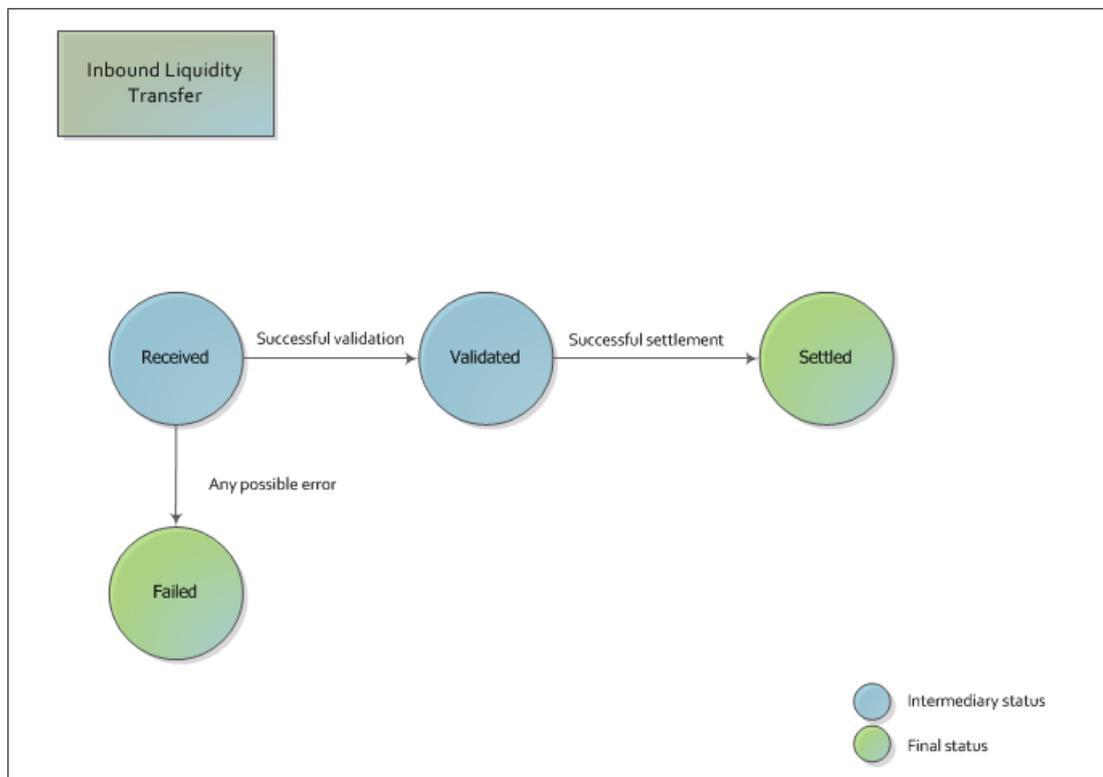

An Inbound Liquidity Transfer order is *Received* and *Validated* by TIPS if it passes all validation checks (see [Table 63 – Inbound Liquidity Transfer Order steps](#)) successfully and the related TIPS Account is not 'blocked for credit' or 'blocked for debit and credit'; otherwise its status is set to *Failed*. Subsequently, it changes to *Settled* status once TIPS settles the full amount of the order. Inbound liquidity transfers involve messages [LiquidityCreditTransfer \(camt.050.001.05\)](#) and [Receipt \(camt.025.001.04\)](#) as well as [BankToCustomerDebitCreditNotification \(camt.054.001.06\)](#) for credit notifications and [ReturnAccount \(camt.004.001.07\)](#) if the account ceiling threshold is exceeded.

Examples involving Inbound Liquidity Transfers are listed in section [2.5.1.1](#).

1.5.3.2. Outbound Liquidity Transfer

An Outbound Liquidity Transfer is used in order to repatriate liquidity from a TIPS Account to the relevant RTGS System. Outbound Liquidity Transfer orders can be triggered in TIPS and are received by the relevant RTGS System. Moreover, if the corresponding RTGS System supports pull functionality, Outbound Liquidity Transfer orders could also be triggered in the RTGS System.

The process foresees that an authorised entity, e.g. a TIPS Participant, Ancillary System, Instructing Party or Central Bank acting on behalf, triggers an Outbound Liquidity Transfer order towards the corresponding RTGS System, in the form of a Liquidity Transfer message. A target account in the RTGS System must be specified in the message. No reservation of funds occurs in this scenario and settlement takes place immediately.

If the Liquidity Transfer request passes all the business checks successfully, TIPS transfers the requested amount from the TIPS Account to the relevant Transit Account and informs the RTGS System. TIPS then expects the RTGS System to reply with either a confirmation or a rejection message.

The possible statuses of an Outbound Liquidity Transfer order are shown in the following diagram.

Figure 11 – Outbound Liquidity Transfer status diagram

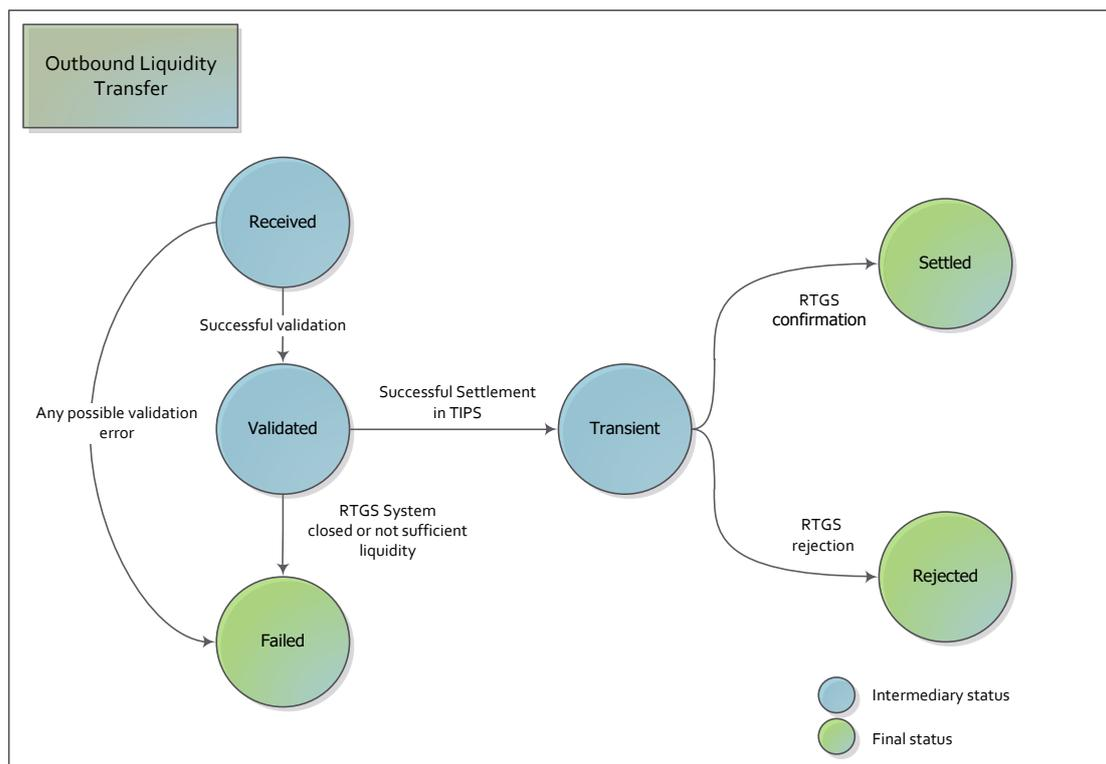

An Outbound Liquidity Transfer order is first *Received* and *Validated* by TIPS if it passes all validations (see [Table 64 – Outbound Liquidity Transfer Order steps](#)) successfully; otherwise its status turns into a *Failed* status. Subsequently, it changes to *Transient* status if settled correctly, when the funds are moved to the technical Transit Account denominated in the same currency of the corresponding liquidity

transfer. Conversely, if the involved TIPS Account is blocked or has insufficient funds, the Liquidity Transfer is set to *Failed*.

The business case of a Liquidity Transfer with status set to *Transient* may then reach its final status (i.e. *Settled*) upon TIPS receiving positive confirmation from the related RTGS System, or be *Rejected* if the RTGS System responds with a negative reply. If the RTGS System sends a negative reply, funds are automatically reversed from the Transit Account to the TIPS Account.

If the RTGS System does not respond properly and the status is not set to *Settled* or *Rejected* within a configurable timeframe, an alert is raised to the TIPS Operator, in order to take corrective measures as explained in [2.5.2.2 “RTGS Alert scenario – No reply from RTGS”](#).

Outbound liquidity transfers can be performed in U2A as well as A2A mode, involving messages [LiquidityCreditTransfer \(camt.050.001.05\)](#), [Receipt \(camt.025.001.05\)](#), [BankToCustomerDebitCreditNotification \(camt.054.001.06\)](#) for debit notifications and [ReturnAccount \(camt.004.001.07\)](#) if the account floor threshold is exceeded.

Examples involving Outbound Liquidity Transfers are listed in section [2.5.2.1](#).

1.5.3.3. Intra-service Liquidity Transfers

An Intra-service Liquidity Transfer moves liquidity from a TIPS Account to a TIPS AS Technical Account (or vice versa) denominated in the same currency. The type of liquidity transfer is used to fund/defund a TIPS AS Technical Account to allow an Ancillary System to process Instant Payments transactions in TIPS.

If the received message passes all the business checks successfully, TIPS transfers the requested amount from the relevant TIPS Account to the TIPS AS Technical Account (or vice versa).

Liquidity transfer orders can have different statuses depending on the executed steps of the settlement process. The possible statuses of an Intra-service Liquidity Transfer order are described in the following diagram.

Figure 12 – Intra-service Liquidity Transfer status diagram

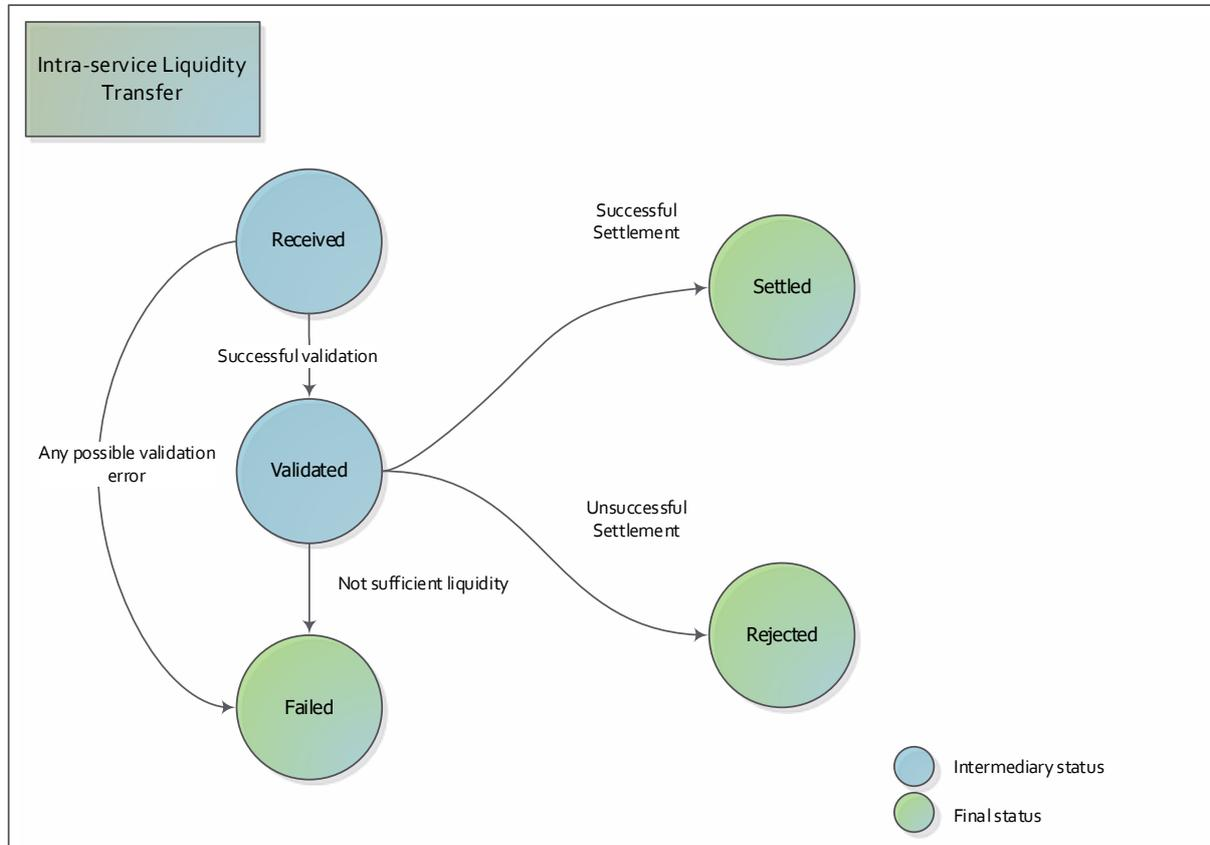

An Intra-service Liquidity Transfer order is *Received* and *Validated* by TIPS if it passes all validation checks (see [Table 66 – Intra-service Liquidity Transfer steps](#)) successfully and the related TIPS Account or TIPS AS Technical Account is not 'blocked for credit' or 'blocked for debit and credit'; otherwise its status is set to *Failed*. Subsequently, it changes to *Settled* status once TIPS settles the full amount of the order. Intra-service liquidity transfers involve messages [LiquidityCreditTransfer \(camt.050.001.05\)](#) and [Receipt \(camt.025.001.05\)](#) as well as [BankToCustomerDebitCreditNotification \(camt.054.001.06\)](#) for credit and debit notifications and [ReturnAccount \(camt.004.001.07\)](#) if either the account ceiling or floor thresholds are exceeded.

Examples involving Intra-service Liquidity Transfers are listed in section [2.5.3.1](#).

1.5.3.4. Reserve calculation

TIPS Accounts in euro and all their balances are, from a legal perspective, considered to be in the jurisdiction of TARGET2. In this respect, TIPS balances can be taken into account for the calculation of the minimum reserve requirements in TARGET2.

Given the 24/7/365 nature of settlement in TIPS, it is necessary to define a single point in time to perform the calculation in a synchronised way between TIPS and TARGET2. To make sure that the balances used for the calculation in TIPS and TARGET2 are coherent, TIPS prepares snapshots of the balances

during the RTGS System end of day procedure, ensuring that no liquidity transfers are pending confirmation from the related RTGS System. These snapshots are the basis for the General Ledger produced by TIPS and forwarded to the linked RTGS Systems.

1.5.4. Reference data management

TIPS Reference data offers Participants, Central Banks and the TIPS Operator an integrated and consistent set of common information, along with the ability to input and maintain reference data of TIPS Participants and their Accounts.

TIPS Reference Data Management is split between TIPS itself and the external Common Reference Data Management component (CRDM). The CRDM allows users to setup and maintain reference data that is common to multiple Eurosystem services, and propagates such data to the relevant services. In this respect, changes to TIPS reference data fall into two categories:

- **Common reference data changes:** this class of operations covers most TIPS reference data changes, notably the creation, update and deletion of Participants and Accounts. These operations are carried out by authorised users in the CRDM via its dedicated interface and propagated to TIPS on a daily basis before the change of RTGS System business day. As the CRDM interface is available 22 hours a day¹² and during the weekdays, this type of operation is only available during that time window. Please refer to CRDM documentation for additional details.

The propagation of Common Reference Data to TIPS is effected through a process that progressively updates all TIPS processing nodes without impacting the 24-hour settlement process.

As the propagation of Common Reference Data requires a certain amount of time each day, it is necessary to input all changes needed for a certain business day before a specific pre-defined cut-off time in advance of said date.

- **Immediate reference data changes:** this class of operations refers to high-priority settlement-relevant reference data changes that need to be implemented in TIPS as soon as they are instructed. These operations are carried out by authorised users directly in TIPS via the TIPS interface (available 24 hours a day) and processed in the same flow as Instant Payment transactions. The possible immediate reference data changes in TIPS are listed below:
 - Blocking/unblocking of a participant;
 - Blocking/unblocking of an account or CMB;
 - Update of a CMB limit (and adjustment of the related headroom).

Blocking/unblocking status and CMB limit data maintenance operations are also available in the CRDM – refer to [1.6.3 “Common Reference Data Management”](#) for additional information.

¹² The timeframe of 22 hours of availability may be subject to revision, depending on possible decisions made in the context of the T2-T2S Consolidation project.

Within TIPS, Reference Data maintenance instructions can be submitted in U2A and A2A mode depending on the individual object. Regardless of the connection mode, all instructions are submitted to the Reference Data Manager component in the same format.

U2A functions can also be triggered in 4-Eyes mode, so that a final approval from a different user is required before the change comes into effect. 4-Eyes mode is not available in A2A mode. When a 4-Eyes instruction is submitted, it is provisionally validated and put on hold until a second user, different from the initial submitter and with the adequate privileges, confirms or revokes it. If the instruction is confirmed, it is submitted to TIPS as any other Reference Data Management instruction.

The following table lists the reference data operations that are available within TIPS, the types of TIPS Actors that are responsible for them and the respective availability in U2A and A2A. All the following operations are available on a 24/7/365 basis and they are implemented with immediate effect in TIPS reference data. Additional reference data management operations are available in the CRDM and are implemented in TIPS as described in section [1.6.3](#).

Table 15 – Reference data management functions available in TIPS

| Entity | Possible operations | Responsible Actors(s) | U2A availability | A2A availability |
|-------------|--|--|------------------|------------------|
| Participant | Update of blocking status | TIPS Operator ¹³ , CB | Yes | Yes |
| Account | Update of blocking status | TIPS Operator ¹³ , CB | Yes | Yes |
| CMB | Update of blocking status, update of CMB limit | TIPS Operator, CB, TIPS Participant, Ancillary System, Instructing Party ¹⁴ | Yes | Yes |

The update of the RTGS System Status table is normally performed on automatic basis upon the receipt of a [ReturnBusinessDayInformation](#) message from the relevant RTGS System. In contingency situations, it can be carried out manually by the TIPS Operator.

1.5.4.1. Blocking Participants

TIPS allows Central Banks to block immediately a TIPS Participant or an Ancillary System falling under their data scope for credit operations, debit operations or both.

Blocking a TIPS Participant for debiting/crediting results in an equivalent blocking on all Accounts owned by that Participant and all the CMBs linked to that Account. The individual Account and CMB blocking status is not overwritten, but a blocking at Participant level always overrides the blocking status at Account or CMB level. In other words, when crediting or debiting a TIPS Account, TIPS also checks the Owner Participant blocking status in addition to the Account or CMB blocking status.

¹³ TIPS Operator can block/unblock Participants, Ancillary Systems, TIPS Accounts, TIPS AS Technical Accounts and CMBs in contingency and upon request of the responsible Central Bank.

¹⁴ An Instructing Party acting on behalf of a TIPS Participant or Ancillary System may block/unblock CMBs owned by the relevant TIPS Participant or Ancillary System, unless restricted via access rights.

This means, for example, that if a TIPS Participant is blocked for credit, all the Accounts owned by the Participant and all the linked CMBs are also blocked for credit regardless of their individual blocking status for credit; regarding debit operations, all the accounts and CMBs retain their individual blocking status for debit. If the TIPS Participant is subsequently unblocked for credit, all the accounts and CMBs also revert to their individual blocking status for credit.

Blocking does not affect reserved amounts; if an amount is reserved for an ongoing payment when the blocking is applied, the payment transaction is completed regardless of participant blocking status.

Unblocking the TIPS Participant means that all of its Accounts and CMBs revert back to their individual blocking status.

The block is performed setting a restriction (through CRDM or directly in TIPS) on the party identifying the TIPS Participant. TIPS performs the block request executing it immediately, without checking if the TIPS Participant is already blocked but overwriting the previous block or adding a new one.

For example, if a TIPS Participant is blocked for credit and TIPS receives a new request of blocking for debit, the Participant (and all related accounts and CMBs) results in a block for both credit and debit operations. If a Participant is blocked for credit and TIPS receives a new request of blocking for credit, the blocking for credit is applied again and the sender of the request is notified with a positive reply.

Similarly, blocking of an Ancillary system results in the blocking of the corresponding TIPS AS Technical Account. If any, also CMBs linked to the TIPS AS Technical Account will be considered as blocked.

Participant blocking can be performed in U2A as well as A2A mode, the latter involving messages [PartyModificationRequest](#) and [PartyStatusAdvice](#).

Examples involving TIPS Participant and Ancillary System blocking are listed in sections [2.9.1.1](#), [2.9.1.2](#), [2.9.1.3](#) and [2.9.1.4](#).

1.5.4.2. Blocking accounts and CMBs

TIPS allows Central Banks to block immediately an account¹⁵ or a CMB linked to TIPS Participant or Ancillary System falling under their data scope for (i) credit operations, (ii) debit operations or (iii) both. TIPS allows TIPS Participants and Ancillary Systems to block immediately a CMB linked to accounts under their data scope for (i) credit operations, (ii) debit operations or (iii) both.

Blocking a TIPS Account or a TIPS AS Technical Account for debiting/crediting results in an equivalent blocking on all CMBs linked to that account. The individual CMB blocking status is not overwritten.

This means, for example, that if a TIPS Account is blocked for credit, all the CMBs linked to the account are also blocked for credit regardless of their individual blocking status for credit; regarding debit operations, all the CMBs retain their individual blocking status for debit. If the TIPS Account is subsequently unblocked for credit, all the CMBs also revert to their individual blocking status for credit.

Blocking does not affect reserved amounts; if an amount is reserved for an ongoing payment when the blocking is applied, the payment transaction is completed regardless of account or CMB blocking status.

¹⁵ A TIPS Account or a TIPS AS Technical Account depending on the owner party type.

Unblocking an account means that all linked CMBs revert back to their individual blocking status.

As explained in case of blocking of a TIPS Actor (see [1.5.4.1 "Blocking Participants"](#)), TIPS performs the block request executing it immediately, without checking if the object itself is already blocked but overwriting the previous block or adding a new one.

Account and CMB blocking can be performed in U2A as well as A2A mode, the latter involving messages [AccountExcludedMandateMaintenanceRequest](#), [AccountRequestAcknowledgement](#) and [AccountRequestRejection](#).

Examples involving Account and CMB blocking are listed in sections [2.9.1.5](#), [2.9.1.6](#) and [2.9.1.7](#).

1.5.4.3. Limit management

TIPS allows Central Banks and TIPS Participants to update the Limits related to CMB falling under their data scope.

When a CMB limit is modified, the headroom of the CMB is updated accordingly. The CMB Headroom is updated (increased or decreased) on the basis of the difference between the new limit value of the CMB and the old limit value: if this difference is positive, the headroom is increased; if the difference is negative, the headroom is decreased.

It is possible, thus, that a change in the limit leads the headroom to becoming negative. In this case the CMB will only accept Instant Payments transactions in credit until the headroom once again goes over zero.

Limit management can be performed in U2A as well as A2A mode, the latter involving messages [ModifyLimit \(camt.011.001.07\)](#) and [Receipt](#).

Examples involving limit management are listed in sections [2.9.1.8](#) and [2.9.1.9](#).

1.5.5. Queries and reports

TIPS allows to perform different categories of real-time queries and a set of pre-defined reports on production data. The dataset on the basis of the Queries and Reports feature are calculated and aggregated on a continuous basis i.e. each time a given instruction is executed, any calculated or aggregated data that depends on the executed instruction is immediately updated.

1.5.5.1. Queries

TIPS provides the query functionality to TIPS actors to satisfy their information needs on demand. It is possible to obtain information on the status of Payment transactions, Liquidity Transfer Orders, Accounts or CMBs by submitting the corresponding query request to TIPS.

In order to manage in a timely manner the liquidity over the accounts and CMBs in the user data scope, the following queries are available both in A2A and U2A modes:

- Account balance and status query;
- CMB limit and status query.

In order to check the status of a previously submitted or received Instant Payment transaction or Recall Response the following query is available both in A2A and U2A modes:

- Payment transaction status query.

In order to check the status of a previously submitted Liquidity Transfer order the following query is available in U2A mode only:

- Liquidity transfer status query.

The following advanced queries for Liquidity Transfers and Payment Transactions are available in U2A mode only:

- Advanced Liquidity transfer status query;
- Advanced Payment transaction status query.

The processing of a Query Request consists in the three following steps:

- execution of the checks on the Query Request message regarding authorisation of the sender and validation of the query;
- retrieval of the data corresponding to the submitted Request and its input parameters;
- sending of the Query Response to the original sender (i.e. the same DN of the query sender).

TIPS shall take into account all access rights while processing queries and only return results if the interested data are part of the TIPS Actor data scope, as defined in the Table 67 – Query permissions.

A brief outline of the purpose of each query and the exact description of its respective selection and return parameters are given

- In section [2.7 “Queries”](#) for the A2A mode;
- In the relevant section of the UHB (see [TARGET Instant Payment Settlement User Handbook](#)) for the U2A mode.

1.5.5.2. Reports

TIPS informs TIPS Actors with a set of predefined reports in order to support business monitoring and reconciliation activities. The predefined reports offered by TIPS are the Statement of Account Turnover and the Statement of Accounts.

The Statement of Account Turnover provides information on the opening/closing balances at start/end of RTGS System business day and the sum of debits/credits for all the TIPS Accounts or TIPS AS Technical Account in the data scope of the TIPS Actor.

The Statement of Accounts provides information on the balances available at the time of report creation for all the TIPS Accounts in the data scope of the TIPS Actor. For each account, detailed information on the related settled transactions (liquidity transfers or Instant Payments) during the reporting period is provided.

TIPS actors can configure their report subscription in the Common Reference Data Management.

These reports are available in A2A push mode only and the data scope of any of them and the moment of generation may be different for different users and depend on their access profiles and configuration (see [Table 69 – Report permissions and data scope](#)). The Statement of Account report can be produced in Full or Delta mode; delta reports include only the relevant data that has changed since the generation of the previous version. The Statement of Account Turnover report is provided in Full mode only.

All the timestamps included in the reports are expressed in UTC.

The creation of a report is triggered at the end of day of the corresponding RTGS System or at the frequency scheduled in the report subscription; the latter is specified in hours (e.g. every 3 hours, every 6 hours, etc.) and it is not relevant for full reports. Report generation process is based on data made available by snapshots of in-memory balances (and transactional data) produced at the time scheduled in the report subscription as explained in detail in section [2.8 “Reports”](#). The report generation starts immediately after the snapshot and the report is sent to the recipient as soon as it is available.

TIPS applies compression to the outgoing reports whenever possible by using ZIP industry standard algorithm.

1.5.6. Raw Data extraction

TIPS produces, on a daily basis, raw data files related to all the activities performed during the day. TIPS relies on the end of day of the underlying RTGS Systems that is communicated via A2A message (see [1.6.1 “T2 and other RTGS Systems”](#)). The raw data files contain the information related to the RTGS Systems business day that has been completed. TIPS does not produce raw data for reference data, as they are provided by the Common Reference Data Management component.

For performance reasons, TIPS does not produce the raw data for billing immediately after the change of business date but during the night. The file is then sent to the BILL common component.

All of the timestamps included in the raw data are expressed in UTC.

TIPS applies compression to the raw data whenever possible by using industry standard algorithms.

The list of expected raw data sent daily to the common components is shown in the following table.

Table 16 – Raw data

| Raw data file | Related information | Receiving Component |
|------------------------|---|---------------------|
| Raw data for billing | Information related to billable items | Billing |
| Raw data for archiving | Transactional data and authentication and security data | Archiving |

Concerning data related to Payment Transactions in non-Euro currencies, TIPS provides on a daily basis a file containing the consumption data to the relevant RTGS System.

1.5.6.1. Raw data for Archiving

TIPS provides the following information to the LeA common component for the Archiving:

- Message signing and content of the settlement messages: FI To FI Customer Credit Transfer, Payment Return, Liquidity transfer, FI To FI Payment Status Report sent from the Beneficiary side to TIPS;
- Transactional data (payment transactions, status messages, liquidity transfers);
- Incoming camt.050 and camt.025 messages received on the internal interface with T2-CLM.

1.5.6.2. Raw data for Billing

The raw data for Billing exported by TIPS contains the information on transactional data. The exhaustive list of exported data is as follows.

Table 17 – Raw data for Billing

| Attribute | Description |
|---------------------------|--|
| Transaction Identifier | Identifier of the Instant Payment transaction or of the positive Recall Response transaction. |
| Business Date | RTGS System business date on which the transaction was processed. |
| Transaction Type | Type of transaction. The exhaustive list of possible values is as follows: <ul style="list-style-type: none"> • IP (Instant Payment) • RA (positive Recall Response) |
| Originator BIC | In case of an IP transaction (Transaction Type = "IP"), it is the BIC11 specified in the "Debtor Agent" ¹⁶ field of the related incoming FI to FI Customer Credit Transfer . In case of a positive Recall Response (Transaction Type = "RA"), it is the BIC11 specified in the "Debtor Agent" ¹⁷ field of the related incoming Payment Return . |
| Beneficiary BIC | In case of an IP transaction (Transaction Type = "IP"), it is the BIC11 specified in the "Creditor Agent" ¹⁸ field of the related incoming FI to FI Customer Credit Transfer . In case of a positive Recall Response (Transaction Type = "RA"), it is the BIC11 specified in the "Creditor Agent" ¹⁹ field of the related incoming Payment Return . |
| Originator Country Code | Country code of the Central Bank which the Originator account belongs to. |
| Beneficiary Country Code | Country code of the Central Bank which the Beneficiary account belongs to. |
| Originator Account Number | In case of an IP transaction (Transaction Type = "IP"), it is the identification number of the debited TIPS Account/TIPS AS Technical Account. In case of a positive Recall Response (Transaction Type = "RA"), it is the identification number of the credited TIPS Account/TIPS AS Technical Account. |

¹⁶ This is the BIC authorised for payments on the account to be debited of the IP and included in the block FIToFICstmrCdtTrf/CdtTrfTxInf/DbtrAgt of the pacs.008 message.

¹⁷ This is the BIC authorised for payments on the account to be credited of the RA and included in the block PmtRtr/TxInf/OrgnlTxRef/DbtrAgt of the pacs.004 message.

¹⁸ This is the BIC authorised for payments on the account to be credited of the IP and included in the block FIToFICstmrCdtTrf/CdtTrfTxInf/CdtrAgt of the pacs.008 message.

¹⁹ This is the BIC authorised for payments on the account to be debited of the RA and included in the block PmtRtr/TxInf/OrgnlTxRef/CdtrAgt of the pacs.004 message.

| | |
|----------------------------|--|
| Beneficiary Account Number | In case of an IP transaction (Transaction Type = "IP"), it is the identification number of the credited TIPS Account/TIPS AS Technical Account. In case of a positive Recall Response (Transaction Type = "RA"), it is the identification number of the debited TIPS Account/TIPS AS Technical Account. |
| Final Status | Final processing status of the transaction. The exhaustive list of possible values is as follows: <ul style="list-style-type: none"> • Settled • Failed • Rejected • Expired |

1.5.6.3. Raw data for Statistics

TIPS produces raw data for statistics on a daily basis. Data are collected and aggregated every day after midnight. Therefore, in order to create an EPC report, the selected period has to be mandatorily over.

1.5.6.4. TIPS Consumption file

To support the billing of Payment Transactions in Swedish Krona, a consumption file is provided to the RTGS system for SEK (i.e. RIX) on a daily basis containing information at transaction level.

1.5.6.4.1 Structure

The file is generated as a fixed length record flat file encapsulated in a XML envelope.

The structure of the records of the TIPS Consumption file is as follows:

Table 18 - RTGS consumption file structure

| O/M | FIELD No. | FIELD NAME | FORMAT | DESCRIPTION |
|-----|-----------|---------------|----------------|---|
| M | 1 | Business Date | DATE(YYYYMMDD) | RTGS business date on which the reported transaction was processed. |

| | | | | |
|---|---|------------------------------------|-------------|---|
| M | 2 | Interested BIC | CHAR(11) | <p>This field reports:</p> <ol style="list-style-type: none"> BIC11 specified in the "Debtor Agent"²⁰ field of the pacs.008 of all the aggregated Settled and Unsettled IP transactions – Debtor side and in the "Debtor Agent"²¹ field of the pacs.004 of all the aggregated Settled and Unsettled RA transactions – Creditor side. BIC11 specified in the "Creditor Agent"²² field of the pacs.008 of all the aggregated Settled and Unsettled IP transactions – Creditor side and in the "Creditor Agent"²³ field of the pacs.004 of all the aggregated Settled and Unsettled RA Transactions – Debtor side; |
| M | 3 | Country Code | CHAR(2) | Country code of the Central Bank which the account belongs to. |
| M | 4 | Account Number | CHAR(34) | Identification number of the TIPS Account interested by the reported transactions (Debtor and Creditor sides). |
| M | 5 | Settled IP Transactions – Debtor | NUMERIC(10) | Number of settled IP transactions – Debtor side (i.e. with final status equal to "Settled") which debited the account. |
| M | 6 | Unsettled IP Transactions – Debtor | NUMERIC(10) | Number of unsettled IP transactions – Debtor side (i.e. with final status different from "Settled") which tried to debit the account. |

²⁰ This is the BIC authorised for payments on the account to be debited of the IP and included in the block FIToFICstmrCdtTrf/CdtTrfTxInf/DbtrAgt of the pacs.008 message.

²¹ This is the BIC authorised for payments on the account to be credited of the RA and included in the block PmtRtr/TxInf/OrgnlTxRef/DbtrAgt of the pacs.004 message.

²² This is the BIC authorised for payments on the account to be credited of the IP and included in the block FIToFICstmrCdtTrf/CdtTrfTxInf/CdtrAgt of the pacs.008 message.

²³ This is the BIC authorised for payments on the account to be debited of the RA and included in the block PmtRtr/TxInf/OrgnlTxRef/CdtrAgt of the pacs.004 message.

| | | | | |
|---|----|--------------------------------------|-------------|--|
| M | 7 | Settled IP Transactions – Creditor | NUMERIC(10) | Number of settled IP transactions – Creditor side (i.e. with final status equal to “Settled”) which credited the account. |
| M | 8 | Unsettled IP Transactions – Creditor | NUMERIC(10) | Number of unsettled IP transactions – Creditor side (i.e. with final status different from “Settled”) which tried to credit the account. |
| M | 9 | Settled RA Transactions – Creditor | NUMERIC(10) | Number of settled RA transactions – Creditor side (i.e. with final status equal to “Settled”) which credited the account. |
| M | 10 | Unsettled RA Transactions – Creditor | NUMERIC(10) | Number of unsettled RA transactions – Creditor side(i.e. with final status different from “Settled”) which tried to credit the account. |
| M | 11 | Settled RA Transactions – Debtor | NUMERIC(10) | Number of settled RA transactions – Debtor side (i.e. with final status equal to “Settled”) which debited the account. |
| M | 12 | Unsettled RA Transactions – Debtor | NUMERIC(10) | Number of unsettled RA transactions – Debtor side (i.e. with final status different from “Settled”) which tried to debit the account. |

The name of the flat file that contains the Consumption data is as follows: TIPSCONFILEYYYYMMDD where YYYYYMMDD specifies the year, month and day on which the reported transaction was processed.

1.5.6.4.2 XML Envelope

TIPS Consumption file content is embedded into a XML Envelope.

The following is the XML schema used to embed the file into a message:

```
<?xml version="1.0" ?>
<xs:schema xmlns="urn:TIPS:TIPSConsumptionfile"
xmlns:xs="http://www.w3.org/2001/XMLSchema"
targetNamespace=" urn:TIPS:TIPSConsumptionfile"
elementFormDefault="qualified">
<xs:simpleType name="RestrictedFileType">
<xs:restriction base="xs:string">
<xs:pattern value="(.{135,135}\n)+" />
</xs:restriction>
</xs:simpleType>
<xs:element name="File" type="File"/>
<xs:complexType name="File">
<xs:simpleContent>
<xs:extension base="RestrictedFileType">
<xs:attribute name="fileId" type="xs:string" default="" />
</xs:extension>
</xs:simpleContent>
</xs:complexType>
</xs:schema>
```

The produced XML file should look as follows:

```
<?xml version="1.0" encoding="UTF-8"?>
<File fileId = "TIPSCONFILE20220523"
xmlns="urn:TIPS:TIPSConsumptionfile">Record1
Record2
...
Recordn
</File>
```

1.5.7. Statistical Indicators for Euro currency

TIPS provides the TIPS Operator with the functionality for creating monthly and quarterly reports for statistical information on Instant Payment, Recall and Investigation transactions.

TIPS Operators are the only users allowed creating the reports. The TIPS Operator, then, provides the report to the requesting CBs.

The created reports remain available in the system for 12 months.

This section describes the statistical indicators provided by TIPS giving useful information about Instant payment transactions, including the transactions being submitted by an Ancillary System to TIPS. All the indicators described below rely on a time frame of a quarter of year or a month, despite the data are collected on a daily basis.

The Indicators are divided into four main categories:

1. General SCT Inst
2. National Transactions
3. Cross-border Transactions
4. Overall monthly figures on payment transactions processed by TIPS

Each indicator is referenced with a code. The reader can refer to [4.3 “List of Indicators”](#) for additional details.

1.5.7.1. General SCT Inst

This category of indicators provides general information about transactions in TIPS, not focusing on qualitative aspects (e.g. the country code of the BIC of the Originator or the Beneficiary) of the operations, but only on quantitative measures. Five indicators belong to this category:

- Number of transactions per Amount;
- Number of transactions per Hour;
- Number of positive confirmation messages per duration of the processing;
- Number of negative confirmation messages per duration of the processing;
- Number of Investigation Requests processed by TIPS.

1.5.7.1.1 Number of IP transactions per Amount

This indicator (TIPS.stat.1) gives the number of all the IP transactions in the period under analysis grouped by the amount of the operation. The final status of the transaction is irrelevant, therefore not only the settled, but also the unsettled operations (‘rejected’, ‘failed’ or ‘expired’) are involved into the calculation of the indicator.

In the table below there are the five amount ranges in which shall be divided the IP transactions:

Table 19 – Number of transactions per Amount

| Amount | Indicator’s reference |
|-----------------|-----------------------|
| < 1.000 | TIPS.stat.1.a |
| 1.000 - 5.000 | TIPS.stat.1.b |
| 5.000 - 10.000 | TIPS.stat.1.c |
| 10.000 – 15.000 | TIPS.stat.1.d |
| ≥ 15.000 | TIPS.stat.1.e |

For every of the three mid-classes, only the left-side extremity is included in the range; whereby, if an IP transaction amounts to 5,000 € it will be part of the third range (5,000 – 10,000), while an operation of 10,000 € belongs to the fourth class (10,000 – 15,000).

1.5.7.1.2 Number of IP transactions per Hour

This indicator (TIPS.stat.2) gives the number of all the IP transactions in the period under analysis grouped by the timestamp of execution. The final status of the transaction is irrelevant, therefore not only the settled, but also but also the unsettled operations ('rejected', 'failed' or 'expired'), are involved in the calculation of the index.

In the table below there are the four time ranges in which shall be divided the IP transactions:

Table 20 – Number of transactions per timestamp

| Hour | Indicator's reference |
|-------------------|-----------------------|
| 00h00 - 06h00 CET | TIPS.stat.2.a |
| 06h00 - 12h00 CET | TIPS.stat.2.b |
| 12h00 - 18h00 CET | TIPS.stat.2.c |
| 18h00 - 00h00 CET | TIPS.stat.2.d |

For every class, only the left-side extremity is included in the range; whereby, if a IP transaction is executed at 06h00 it will be part of the second range (06h00 - 12h00 CET), while an operation occurred at 12h00 belongs to the third range (12h00 - 18h00 CET).

1.5.7.1.3 Number of positive confirmation messages per duration of the processing

This indicator (TIPS.stat.3) gives the number of settled IP transactions divided by duration of the processing. In case of IP transaction with positive result, the duration of the processing is calculated as the time elapsed from acceptance timestamp to the settlement timestamp, i.e. with the reception of the positive confirmation messages.

In the table below there are the six time ranges in which shall be divided the IP transactions:

Table 21 – Number of settled transactions per duration of processing

| Receipt of confirmation message | Indicator's reference |
|---------------------------------|-----------------------|
| Within 5 seconds | TIPS.stat.3.a |
| Within 10 seconds | TIPS.stat.3.b |
| Within 15 seconds | TIPS.stat.3.c |
| Within 20 seconds | TIPS.stat.3.d |
| Within 25 seconds | TIPS.stat.3.e |
| > 25 seconds | TIPS.stat.3.f |

For every class the upper extremity is included in the range; whereby, if a message is received after exactly 10 seconds it will be part of the second class.

1.5.7.1.4 Number of negative confirmation messages per duration of the processing

This indicator (TIPS.stat.4) gives the number of unsettled IP Transaction (i.e. 'rejected', 'failed' or 'expired') divided by duration of the processing. In case of IP transaction with negative result, the

duration of the processing is calculated as the time elapsed from the acceptance timestamp and the timestamp by when the transaction reached its final status, i.e. with the reception of the negative confirmation messages. Furthermore, if no confirmation message is received, neither positive nor negative, the transaction is considered unsettled and counted in specific time range (“No confirmation”). In the table below there are the seven ranges in which shall be divided the IP transactions:

Table 22 – Number of unsettled IP transactions per duration of processing

| Receipt of confirmation message | Indicator’s reference |
|---------------------------------|-----------------------|
| Within 5 seconds | TIPS.stat.4.a |
| Within 10 seconds | TIPS.stat.4.b |
| Within 15 seconds | TIPS.stat.4.c |
| Within 20 seconds | TIPS.stat.4.d |
| Within 25 seconds | TIPS.stat.4.e |
| > 25 seconds | TIPS.stat.4.f |
| no confirmation after 25 sec | TIPS.stat.4.g |

For every class the upper extremity is included in the range; whereby, if a message is received after exactly 5 seconds it will be part of the first class.

1.5.7.1.5 Number of Investigation Requests processed by TIPS

This indicator (TIPS.stat.5) gives the total amount of investigations requested in TIPS. Differently from the previous measures, in this case there is no division in classes; obviously this occurs because the information provided refers to all investigations processed by TIPS, regardless the time of the request and the type of actor who requested it.

Table 23 – Number of investigation requests

| Number of Investigations | Indicator’s reference |
|--------------------------|-----------------------|
| Investigations | TIPS.stat.5.a |

1.5.7.2. National Transactions

This category of indicators provides information about IP transactions, recall requests and request for recall by the originator executed in a national context in a given quarter/ month of the year. Consequently, the operations taken into consideration refer to an Originator PSP and a Beneficiary PSP that belong to the same country and therefore hold the same Country code of the BIC. Six Indicators belong to this category:

- Number of national IP transactions;
- Number of national IP transactions with an unsettled status;
- Number of national Recall Requests;
- Number of national IP transactions with an unsettled status and grouped by reason code;

- Number of national Recall Requests grouped by reason code;
- Number of national Request for Recall by Originator

Each index provides the number of operations grouped by the country code of the actors. In other words, TIPS provides the exact number of transaction/recall carried out for every country code of the BIC, when the IP transaction or recall is operated by two PSPs from the same country.

Besides, TIPS analyses the unsettled IPs and the Recall Requests grouped by reason code. TIPS distinguishes the Reason codes between three categories:

- Internal Reason Code: Error code generated by TIPS and compliant with SCT^{Inst} scheme;
- External Reason Code: Error code generated by other systems outside TIPS and compliant with SCT^{Inst} scheme.
- TIPS reason code: Error code generated and defined only in TIPS and not in SCT^{Inst} scheme.

The only reason codes by which the indicators can be grouped are those generated by TIPS. All the other operations are grouped inside the category “External Reason Code”.

For the list of error code generated by TIPS see section [4.2.1 “List of ISO Error codes”](#).

1.5.7.2.1 Number of national IP transactions

This indicator (TIPS.stat.6) gives the number of all the national IP transactions in the period under analysis grouped by the common Country code of the BIC of the actors (Originator PSP and Beneficiary PSP). The final status of the transaction is irrelevant, therefore not only the settled, but also the unsettled operations (‘rejected’, ‘failed’ or ‘expired’), are involved into the calculation of the index.

Table 24 – Number of national IP transactions

| Transactions Per country | Indicator’s reference |
|-----------------------------|---|
| [Country code] _x | TIPS.stat.6.[Country code] _x |

The indicator returns a value for each Country whose BIC has executed a transaction in the period under analysis.

1.5.7.2.2 Number of national IP transactions with an unsettled status

This indicator (TIPS.stat.7) gives the number of unsettled IP transaction in the period under analysis grouped by the common Country code of the BIC of the actors (Originator PSP and Beneficiary PSP). As mentioned above ([1.5.7.2 “National Transactions”](#)), the data are divided by country code of the actors, and consequently the indicator shows, for each Country, the number of IP transactions with status different from “Settled”: Furthermore there is no specification between the final status of each transaction (i.e. ‘rejected’, ‘failed’ or ‘expired’).

Table 25 – Number of national Unsettled IP Transactions

| Unsettled Transactions per country | Indicator’s reference |
|------------------------------------|---|
| [Country code] _x | TIPS.stat.7.[Country code] _x |

1.5.7.2.3 Number of national Recall Requests

This indicator (TIPS.stat.8) gives the number of Recall Requests sent on a selected period and grouped by the common Country code of the BIC of the actors (Originator PSP and Beneficiary PSP). The Indicator does not take into consideration the outcome of the Recall, therefore is irrelevant if the response message is negative or positive. In addition, only the Recall Requests successfully sent to the Beneficiary are taken in consideration for the calculation of the indicator.

Table 26 – Number of national Recall Requests

| Recall Requests per country | Indicator's reference |
|-----------------------------|---|
| [Country code] _x | TIPS.stat.8.[Country code] _x |

1.5.7.2.4 Number of national Unsettled IP transactions grouped by reason code

This indicator (TIPS.stat.9) gives the number of unsettled IP transaction of a selected period and grouped by the common Country code of the BIC of the actors and by Reason Code. The transactions taken into account are the same analysed in paragraph [1.5.7.2.2](#), i.e. the number of transactions with status different from “Settled”, not looking at the final status of each transaction (i.e. ‘rejected’, ‘failed’ or ‘expired’). Moreover, in addition to the Country code of the BIC of the actors, all the transactions are grouped looking at the Reason Code for non-acceptance of the SCT^{Inst} Transaction. Consequently, the total number of transactions given by this indicator and the indicator from paragraph [1.5.7.2.2](#) shall be the same. The only Reason codes taken in consideration are those generated by TIPS (Internal Reason Code, see [1.5.7.2](#)). Therefore, all the IPs with status unsettled and with a Reason code not generated by TIPS, are grouped into a generic Code called “External Reason Code”.

Table 27 – National Unsettled IP Transaction per Reason Code

| Transactions per Reason Code | Indicator's reference |
|--|--|
| [Country code] _x [Reason code] _y | TIPS.stat.9.[Country code] _x [Reason code] _y |

1.5.7.2.5 Number of national Recall Requests grouped by reason code

This indicator (TIPS.stat.10) gives the number of Recall Requests sent on a selected period and grouped by the common Country code of the BIC of the actors and by Reason Code. The Recall requests taken into account are the same analysed in paragraph [1.5.7.2.3](#), i.e. only those sent to the Beneficiary irrespective if the response message is negative or positive. Moreover, in addition to the Country code of the BIC of the actors, all the Recall Requests are grouped looking at the Reason Code for non-acceptance of the SCT^{Inst} Transaction.

The Reason codes taken in consideration are the following:

- DUPL: Duplicate Sending
- FRAD: Fraudulent Origin
- TECH: Technical Problem resulting in erroneous SCT Inst

Table 28 – National Recall Requests per Reason Code

| Recall per Reason Code | Indicator's reference |
|--|---|
| [Country code] _x [Reason code] _y | TIPS.stat.10.[Country code] _x [Reason code] _y |

1.5.7.2.6 Number of national Request for Recall by Originator

This indicator (TIPS.stat.11) gives the number of Requests for Recall sent on a selected period and grouped by the common country code of the BIC of the involved PSPs. The Indicator does not take into consideration the outcome of the Recall, therefore is irrelevant if the response message is negative or positive. In addition, only the Recall Requests successfully sent to the Beneficiary are taken in consideration for the calculation of the index. In order to distinguish a Recall Request from a Request for Recall, the latter shall be defined by the following parameters:

- Index 4.18 'Originator' shall be populated with AT-02 "The name of the Originator".
- Index 4.20 'Reason Code' shall be populated with ISO code "CUST" (Requested by Customer).
- Index 4.21 'Reason Proprietary' shall be populated with the proprietary codes "AM09" (Wrong amount) and "AC03" (Wrong IBAN).

Table 29 – National Requests for Recall

| Requests for Recall per country | Indicator's reference |
|---------------------------------|--|
| [Country code] _x | TIPS.stat.11.[Country code] _x |

1.5.7.3. Cross-border Transactions

This category of indicators provides information about TIPS cross-border transactions, recall requests and request for recall in a given month/quarter of the year. Consequently, the operations taken into consideration refer to an Originator PSP and a Beneficiary PSP that belong to different countries and therefore hold different country codes of the BIC. In view of this aspect, each operation shall be considered both from the Originator and the Beneficiary side; consequently, there are more indicators referring to the Cross-border transactions, compared to National Transactions (see [1.5.7.2](#)). In particular, for each class of indicator, there are two measures to be considered, one from the Originator Side and one from Beneficiary side²⁴. The Indicators that belong to this category are twelve:

- Number of cross-border IP transactions
 - o Sent by the Originator and grouped by his country code of the BIC
 - o Received by the Beneficiary and grouped by his country code of the BIC
- Number of cross-border IP transactions with an unsettled status
 - o Sent by the Originator and grouped by his country code of the BIC
 - o Received by the Beneficiary and grouped his by country code of the BIC

²⁴ Means all transactions that have been processed and sent by TIPS to the beneficiary. Any problems in receiving the messages from the beneficiary side that cannot be ascribed to a TIPS malfunction will still be counted within the indicators.

- Number of cross-border Recall Requests
 - o Sent by the Originator and grouped by his country code of the BIC
 - o Received by the Beneficiary and grouped by his country code of the BIC
- Number of cross-border IP transactions with an unsettled status and grouped by reason code
 - o Sent by the Originator and grouped by his country code of the BIC
 - o Received by the Beneficiary and grouped by his country code of the BIC
- Number of cross-border Recall Requests grouped by reason code
 - o Sent by the Originator and grouped by his country code of the BIC
 - o Received by the Beneficiary and grouped by his country code of the BIC
- Number of cross-border Request for Recall by Originator
 - o Sent by the Originator and grouped by his country code of the BIC
 - o Received by the Beneficiary and grouped by his country code of the BIC

As for the National indicators, TIPS distinguishes the Reason codes between three categories:

- Internal Reason Code: Error code generated by TIPS;
- External Reason Code: Error code generated by other systems outside TIPS;
- TIPS reason code: Error code generated and defined only in TIPS.

The only reason codes by which the indicators can be grouped are those generated by TIPS (see [1.5.7.2](#)). All the other operations are grouped inside the category “External Reason Code”.

1.5.7.3.1 Number of cross-border IP transactions

These indicators give the number of all the cross-border IP transactions of a selected time period. The final status of the transaction is irrelevant, therefore not only the settled, but also the unsettled operations ('rejected', 'failed' or 'expired'), are involved into the calculation of the index. Depending on which country code of the actors is considered, there are two different indicators:

- Number of cross-border transaction sent by the Originator and grouped by his country code of the BIC (TIPS.stat.12);
- Number of cross-border transaction received by the Beneficiary and grouped by his country code of the BIC (TIPS.stat.13).

Table 30 – Number of cross-border IP transactions

| Transactions per Originator country | Indicator's reference |
|--------------------------------------|--|
| [Country code] _x | TIPS.stat.12.[Country code] _x |
| Transactions per Beneficiary country | Indicator's reference |
| [Country code] _x | TIPS.stat.13.[Country code] _x |

1.5.7.3.2 Number of cross-border IP transactions with an unsettled status

These indicators give the number of unsettled cross-border IP transaction of a selected time period. The data are divided by country code of the actors, and consequently the indicator shows, for each Country, the number of transactions with status different from “Settled”: Furthermore, there is no specification between the final status of each transaction (i.e. ‘rejected’, ‘failed’ or ‘expired’).

Depending on which country code of the actors is considered, there are two different indicators:

- Number of cross-border unsettled transaction sent by the Originator and grouped by its country code of the BIC (TIPS.stat.14);
- Number of cross-border unsettled transaction received by the Beneficiary and grouped by its country code of the BIC (TIPS.stat.15).

Table 31 – Number of cross-border Unsettled IP Transactions

| Unsettled Transactions per Originator country | Indicator’s reference |
|--|--|
| [Country code] _x | TIPS.stat.14.[Country code] _x |
| Unsettled Transactions per Beneficiary country | Indicator’s reference |
| [Country code] _x | TIPS.stat.15.[Country code] _x |

1.5.7.3.3 Number of cross-border Recall Requests

These indicators give the number of Recall Requests sent on a selected time period. The Indicators do not take into consideration the outcome of the Recall, therefore is irrelevant if the response message is negative or positive. In addition, only the Recall Requests successfully sent to the Beneficiary are taken in consideration for the calculation of the indicator.

Depending on which country code of the actors is considered, there are two different indicators:

- Number of cross-border Recall Request sent by the Originator and grouped by its country code of the BIC of (TIPS.stat.16);
- Number of cross-border Recall Request received by the Beneficiary and grouped by its country code of the BIC (TIPS.stat.17).

Table 32 – Number of cross-border Recall Requests

| Recall Requests per Originator country | Indicator’s reference |
|---|--|
| [Country code] _x | TIPS.stat.16.[Country code] _x |
| Recall Requests per Beneficiary country | Indicator’s reference |
| [Country code] _x | TIPS.stat.17.[Country code] _x |

1.5.7.3.4 Number of cross-border IP transactions with an unsettled status and grouped by reason code

These indicators give the number of unsettled IP transaction of a selected time period. The transactions taken into account are the same analysed in paragraph [1.5.7.3.2](#), i.e. the number of transactions with

status different from “Settled”, not looking at the final status of each transaction (i.e. ‘rejected’, ‘failed’ or ‘expired’). Moreover, in addition to the Country code of the BIC of the actors, all the transactions are grouped looking at the Reason Code for non-acceptance of the SCT^{Inst} Transaction.

The only Reason codes taken in consideration are those generated by TIPS (Internal Reason Code, see [1.5.7.3](#)). Therefore, all the IPs with status unsettled and with a Reason code not generated by TIPS, are grouped into a generic Code called “External Reason Code”.

Depending on which country code of the actors is considered, there are two different indicators:

- Number of cross-border unsettled transaction sent by the Originator and grouped by his country code of the BIC and reason code (TIPS.stat.18);
- Number of cross-border unsettled transaction received by the Beneficiary grouped by his country code of the BIC and reason code (TIPS.stat.19).

Table 33 – Cross-border Unsettled Transaction per Reason Code

| Transactions per Reason Code and Originator Country | Indicator’s reference |
|--|---|
| [Country code] _x [Reason code] _y | TIPS.stat.18.[Country code] _x [Reason code] _y |
| Transactions per Reason Code and Beneficiary Country | Indicator’s reference |
| [Country code] _x [Reason code] _y | TIPS.stat.19.[Country code] _x [Reason code] _y |

1.5.7.3.5 Number of cross-border Recall Requests grouped by reason code

These indicators give the number of Recall Requests sent on a selected time period. The Recall requests taken into account are the same analysed in paragraph [1.5.7.3.3](#), i.e. only those sent to the Beneficiary irrespective if the response message is negative or positive. Moreover, in addition to the country code of the BIC of the actors, all the Recall Requests are grouped looking at the Reason Code for non-acceptance of the SCT^{Inst} Transaction.

The Reason codes taken in consideration are the following:

- DUPL: Duplicate Sending
- FRAD: Fraudulent Origin
- TECH: Technical Problem

Depending on which country code of the actors is considered, there are two different indicators:

- Number of cross-border Recall Request sent by the Originator and grouped by its country code of the BIC and Reason Code (TIPS.stat.20);
- Number of cross-border Recall Request received by the Beneficiary grouped by its country code of the BIC and Reason Code (TIPS.stat.21).

Table 34 – Number of Cross-border Recall Requests per Reason code

| Recall per Reason Code and Originator country | Indicator’s reference |
|--|--|
| [Country code] _x [Reason code] _y | TIPS.stat.20.[Country code] _x |

| Recall per Reason Code and Originator country | Indicator's reference |
|--|--|
| Recall per Reason Code and Beneficiary country | Indicator's reference |
| [Country code] _x [Reason code] _y | TIPS.stat.21.[Country code] _x |

1.5.7.3.6 Number of cross-border Request for Recall by Originator

These indicators give the number of Requests for Recall sent on a selected time period. The indicators do not take into consideration the outcome of the Recall, therefore is irrelevant if the response message is negative or positive. The criteria to follow in order to distinguish a Recall Request from a Request for Recall are defined in paragraph [1.5.7.2.6](#).

Depending on which country code of the actors is considered, there are two different indicators:

- Number of cross-border Request for Recall sent by the Originator and grouped by its country code of the BIC (TIPS.stat.22);
- Number of cross-border Request for Recall received by the Beneficiary and grouped by its country code of the BIC (TIPS.stat.23).

Table 35 – Cross-Border Requests for Recall

| Requests for Recall per Originator country | Indicator's reference |
|---|--|
| Requests for Recall per Beneficiary country | Indicator's reference |
| [Country code] _x | TIPS.stat.22.[Country code] _x |
| [Country code] _x | TIPS.stat.23.[Country code] _x |

1.5.7.4. Overall monthly figures on payment transactions processed by TIPS

This category of indicators provides general information about volume and value of payment transactions²⁵ settled in TIPS. Two main sets of indicators belong to this category:

- Volume and value of national payment transactions settled;
- Volume and value of cross-border transactions settled.

For both categories, the statistical indicators will provide the breakdown by country code of the settled payment transactions. The relevant figures will be provided to the interested parties by means of an operational report generated on a monthly basis.

1.5.7.4.1 Volume of national payment transactions

This indicator provides the number of payment transactions settled grouped by the country code of the BIC of the Originator PSP.

Table 36 – Number of national settled payment transactions

| Number of settled payment transactions per Originator country | Indicator's reference |
|---|--|
| [Country code] _x | TIPS.stat.24.[Country code] _x |

²⁵ A payment transaction in this context includes Instant Payments and Positive Recall Responses successfully settled.

1.5.7.4.2 Value of national payment transactions

This indicator provides the total value of payment transactions settled grouped by the country code of the BIC of the Originator PSP.

Table 37 – Value of national settled payment transactions

| Value of settled payment transactions per Originator country | Indicator's reference |
|--|--|
| [Country code] _x | TIPS.stat.25.[Country code] _x |

1.5.7.4.3 Volume of cross-border payment transactions

This indicator provides the number of payment transactions settled grouped by the country code. The indicator will provide the figures from both the viewpoint (i) of country code of the BIC of the Originator PSP and (ii) of country code of the BIC of the Beneficiary PSP.

Table 38 – Number of Cross-Border settled payment transactions

| Number of settled payment transactions per Originator country | Indicator's reference |
|--|--|
| [Country code] _x | TIPS.stat.26.[Country code] _x |
| Number of settled payment transactions per Beneficiary country | Indicator's reference |
| [Country code] _x | TIPS.stat.27.[Country code] _x |

1.5.7.4.4 Value of cross-border payment transactions

This indicator provides the total value of payment transactions settled grouped by the country code. The indicator will provide the figures from both the viewpoint (i) of country code of the BIC of the Originator PSP and (ii) of country code of the BIC of the Beneficiary PSP.

Table 39 – Value of Cross-Border settled payment transactions

| Value of settled payment transactions per Originator country | Indicator's reference |
|---|--|
| [Country code] _x | TIPS.stat.28.[Country code] _x |
| Value of settled payment transactions per Beneficiary country | Indicator's reference |
| [Country code] _x | TIPS.stat.29.[Country code] _x |

1.5.8. Statistical Indicators for non-Euro currency

TIPS provides the TIPS Operator with the functionality for creating monthly and quarterly reports for statistical information on Instant Payment, Recall and Investigation transactions in non-Euro currency.

TIPS Operators are the only users allowed creating the reports. The TIPS operator, then, provides the report to the relevant CB.

The created reports remain available in the system for 12 months.

This section describes the statistical indicators provided by TIPS giving useful information about Instant Payment transactions. All the indicators described below rely on a time frame of a quarter of year or of a month, despite the data are collected on a daily basis.

The Indicators are divided into two main categories, taking SEK currency as a reference:

1. General figures
2. National Transactions

Each indicator is referenced with a code. The reader can refer to [4.3.4 "List of general indicators for non-Euro currencies"](#) for additional details.

1.5.8.1. General figures

This category of indicators provides general information about TIPS transactions denominated in a currency different from euro (e.g. SEK), not focusing on qualitative aspects (e.g. the country code of the BIC of the Originator or the Beneficiary) of the operations, but only on quantitative measures. Seven indicators belong to this category:

- Number of IP transactions in SEK, per Amount;
- Number of IP transactions in SEK, per Hour;
- Number of positive confirmation messages per duration of the processing;
- Number of negative confirmation messages per duration of the processing;
- Total number of Investigation Requests for IP in SEK, processed by TIPS;
- Total number of IP transactions in SEK with a settled status;
- Total value of IP transactions in SEK with a settled status.

1.5.8.1.1 Number of IP transactions in SEK per Amount

This indicator (TIPS.stat.M1) gives the number of all the IP transactions in the period under analysis grouped by the amount of the operation and divided by currency (e.g. SEK). The final status of the transaction is irrelevant, therefore not only the settled, but also the unsettled operations ('rejected', 'failed' or 'expired') are involved into the calculation of the indicator.

In the table below there are the twelve amount ranges in which each IP transaction shall be classified.

Table 40 – Number of transactions in SEK per Amount

| Amount | Indicator's reference |
|--------------------------------|-----------------------|
| < 100 SEK | TIPS.stat.M1.a |
| >= 100 SEK and < 500 SEK | TIPS.stat.M1.b |
| >= 500 SEK and < 1,000 SEK | TIPS.stat.M1.c |
| >= 1,000 SEK and < 5,000 SEK | TIPS.stat.M1.d |
| >= 5,000 SEK and < 10,000 SEK | TIPS.stat.M1.e |
| >= 10,000 SEK and < 50,000 SEK | TIPS.stat.M1.f |

| | |
|--|----------------|
| >= 50,000 SEK and < 100,000 SEK | TIPS.stat.M1.g |
| >= 100,000 SEK and <= 500,000 SEK | TIPS.stat.M1.h |
| >= 500,000 SEK and <= 1,000,000 SEK | TIPS.stat.M1.i |
| >= 1,000,000 SEK and <= 5,000,000 SEK | TIPS.stat.M1.j |
| >= 5,000,000 SEK and <= 10,000,000 SEK | TIPS.stat.M1.k |
| > 10,000,000 SEK | TIPS.stat.M1.l |

For every class - between TIPS.stat.M1.b and TIPS.stat.M1.k - only the left-side extremity is included in the range, whereby, if an IP transaction amounts whose amount is equal to 500 SEK, it will be part of the third range (500 – 1.000), while an IP transaction whose amount is equal to 1.000 SEK is classified into the fourth class (1,000 – 5.000).

1.5.8.1.2 Number of IP transactions in SEK per Hour

This indicator (TIPS.stat.M2) gives the number of all the IP transactions in the period under analysis grouped by the timestamp of execution. The final status of the transaction is irrelevant, therefore not only the settled, but also the unsettled operations ('rejected', 'failed' or 'expired'), are involved in the calculation of the indicator.

In the table below there are the twenty-four time ranges in which each IP transaction can be classified:

Table 41 – Number of transactions in SEK per timestamp

| Hour | Indicator's reference |
|-------------------|-----------------------|
| 00h00 - 01h00 CET | TIPS.stat.M2.a |
| 01h00 - 02h00 CET | TIPS.stat.M2.b |
| 02h00 - 03h00 CET | TIPS.stat.M2.c |
| 03h00 - 04h00 CET | TIPS.stat.M2.d |
| 04h00 - 05h00 CET | TIPS.stat.M2.e |
| 05h00 - 06h00 CET | TIPS.stat.M2.f |
| 06h00 - 07h00 CET | TIPS.stat.M2.g |
| 07h00 - 08h00 CET | TIPS.stat.M2.h |
| 08h00 - 09h00 CET | TIPS.stat.M2.i |
| 09h00 - 10h00 CET | TIPS.stat.M2.j |
| 10h00 - 11h00 CET | TIPS.stat.M2.k |
| 11h00 - 12h00 CET | TIPS.stat.M2.l |
| 12h00 - 13h00 CET | TIPS.stat.M2.m |
| 13h00 - 14h00 CET | TIPS.stat.M2.n |
| 14h00 - 15h00 CET | TIPS.stat.M2.o |
| 15h00 - 16h00 CET | TIPS.stat.M2.p |
| 16h00 - 17h00 CET | TIPS.stat.M2.q |
| 17h00 - 18h00 CET | TIPS.stat.M2.r |

| Hour | Indicator's reference |
|-------------------|-----------------------|
| 18h00 - 19h00 CET | TIPS.stat.M2.s |
| 19h00 - 20h00 CET | TIPS.stat.M2.t |
| 20h00 - 21h00 CET | TIPS.stat.M2.u |
| 21h00 - 22h00 CET | TIPS.stat.M2.v |
| 22h00 - 23h00 CET | TIPS.stat.M2.w |
| 23h00 - 24h00 CET | TIPS.stat.M2.x |

For every class, only the left-side extremity is included in the range; whereby, if an IP transaction is executed at 06h00 it will be part of the range (06h00 - 07h00 CET).

1.5.8.1.3 Number of positive confirmation messages per duration of the processing

This indicator (TIPS.stat.M3) provides the number of settled IP transactions divided by overall duration of the processing. In case of IP transaction with positive result, the duration of the processing is calculated as the time elapsed from acceptance timestamp to the settlement timestamp, i.e. with the reception of the positive confirmation messages.

In the table below there are the eleven time ranges in which an IP transaction can be classified:

Table 42 – Number of settled transactions in SEK per duration of processing

| Receipt of confirmation message | Indicator's reference |
|---------------------------------|-----------------------|
| ≤ 0,5 second | TIPS.stat.M3.a |
| > 0,5 second and ≤ 1 second | TIPS.stat.M3.b |
| > 1 second and ≤ 2 seconds | TIPS.stat.M3.c |
| > 2 seconds and ≤ 3 seconds | TIPS.stat.M3.d |
| > 3 seconds and ≤ 4 seconds | TIPS.stat.M3.e |
| > 4 seconds and ≤ 5 seconds | TIPS.stat.M3.f |
| > 5 seconds and ≤ 10 seconds | TIPS.stat.M3.g |
| > 10 seconds and ≤ 15 seconds | TIPS.stat.M3.h |
| > 15 seconds and ≤ 20 seconds | TIPS.stat.M3.i |
| > 20 seconds and ≤ 25 seconds | TIPS.stat.M3.j |
| > 25 seconds | TIPS.stat.M3.k |

For every class the upper extremity is included in the range; whereby, if a message is received after exactly 10 seconds it will be part of the seventh class (i.e. > 5 seconds and ≤ 10 seconds).

1.5.8.1.4 Number of negative confirmation messages per duration of the processing

This indicator (TIPS.stat.M4) gives the number of unsettled IP Transaction (i.e. 'rejected', 'failed' or 'expired') divided by duration of the processing. In case of an IP transaction with negative result, the

duration of the processing is calculated as the time elapsed from the acceptance timestamp and the timestamp by when the transaction reached its final status, e.g. with the reception of the negative confirmation message. Furthermore, if, neither positive nor negative confirmation message is received, the transaction is considered unsettled and counted in a specific time range (i.e. “no confirmation after 25 sec.”).

In the table below there are the seven ranges in which each IP transaction shall be classified:

Table 43 – Number of unsettled IP transactions in SEK per duration of processing

| Receipt of confirmation message | Indicator’s reference |
|---------------------------------|-----------------------|
| ≤ 5 seconds | TIPS.stat.M4.a |
| > 5 seconds and ≤ 10 seconds | TIPS.stat.M4.b |
| > 10 seconds and ≤ 15 seconds | TIPS.stat.M4.c |
| > 15 seconds and ≤ 20 seconds | TIPS.stat.M4.d |
| > 20 seconds and ≤ 25 seconds | TIPS.stat.M4.e |
| > 25 seconds | TIPS.stat.M4.f |
| no confirmation after 25 sec | TIPS.stat.M4.g |

For every class the upper extremity is included in the range; whereby, if a message is received after exactly 5 seconds it will be part of the first class.

1.5.8.1.5 Number of Investigation Requests processed by TIPS

This indicator (TIPS.stat.M5) gives the total amount of investigations requested in TIPS. In this case, contrarily from the previous indicators, classes are not foreseen. This occurs because the information provided refers to all investigations processed by TIPS, regardless the time of the request and the type of actor who requested it.

Table 44 – Number of investigation requests relevant to IP in SEK

| Number of Investigations | Indicator’s reference |
|--------------------------|-----------------------|
| Investigations | TIPS.stat.M5.a |

1.5.8.2. National Transactions

This category of indicators provides information about IP transactions, recall requests and request for recall by the originator executed in a national context in a given quarter/month of the year. Consequently, the operations taken into consideration refer to an Originator Bank and a Beneficiary Bank that belong to the same country and therefore hold the same country code of the BIC. Six Indicators belong to this category:

- Number of national IP transactions;
- Number of national IP transactions with an unsettled status;

- Number of national Recall Requests;
- Number of national IP transactions with an unsettled status and grouped by reason code;
- Number of national Recall Requests grouped by reason code;
- Number of national Request for Recall by Originator

Each indicator provides the number of operations grouped by the country code of the actors. In other words, TIPS provides the exact number of transaction/recall carried out when the IP transaction or recall is operated by two banks from the same country.

Besides, TIPS analyses the unsettled IPs and the Recall Requests grouped by reason code. TIPS distinguishes the Reason codes into three categories:

- Internal Reason Code: Error code generated by TIPS;
- External Reason Code: Error code generated by other systems outside TIPS;
- TIPS reason code: Error code generated and defined only in TIPS.

The only reason codes by which the indicators can be grouped are those generated by TIPS. All the other operations are grouped inside the category “External Reason Code”.

For the list of error code generated by TIPS the reader can refer to section [4.2.1 “List of ISO Error codes”](#).

1.5.8.2.1 Number of national IP transactions

This indicator (TIPS.stat.M6) gives the number of all the national IP transactions in the period under analysis grouped by the common country code of the BIC of the actors (Originator Bank and Beneficiary Bank). The final status of the transaction is irrelevant, therefore not only the settled, but also the unsettled operations (‘rejected’, ‘failed’ or ‘expired’), are taken into account for the calculation of this indicator.

Table 45 – Number of national IP transactions in SEK

| Transactions Per country | Indicator’s reference |
|--------------------------|-----------------------------|
| [Country code] | TIPS.stat.M6.[Country code] |

The indicator returns a value for the country code (e.g. SE, if currency is SEK) related to the given currency whose BIC has executed a transaction in the period under analysis.

1.5.8.2.2 Number of national IP transactions with an unsettled status

This indicator (TIPS.stat.M7) gives the number of unsettled IP transaction in the period under analysis grouped by the common country code of the BIC of the actors (Originator Bank and Beneficiary Bank). As mentioned above (see [1.5.8.2 “National Transactions”](#)), the data are divided by country code of the actors, and consequently the indicator shows, for the country code (e.g. SE, if currency is SEK) related to the given currency, the number of IP transactions with status different from “Settled”.

Furthermore, there is no differentiation across the final status of each transaction (i.e. 'rejected', 'failed' or 'expired').

Table 46 – Number of national Unsettled IP Transactions in SEK

| Unsettled Transactions per country | Indicator's reference |
|------------------------------------|-----------------------------|
| [Country code] | TIPS.stat.M7.[Country code] |

1.5.8.2.3 Number of national Recall Requests

This indicator (TIPS.stat.M8) gives the number of Recall Requests sent on a selected period and grouped by the common country code of the BIC of the actors (Originator Bank and Beneficiary Bank). The Indicator does not take into consideration the outcome of the Recall, therefore is irrelevant if the answer message is negative or positive. In addition, only the Recall Requests successfully sent to the Beneficiary are taken in consideration for the calculation of the indicator.

Table 47 – Number of national Recall Requests

| Recall Requests per country | Indicator's reference |
|-----------------------------|-----------------------------|
| [Country code] | TIPS.stat.M8.[Country code] |

1.5.8.2.4 Number of national Unsettled IP transactions grouped by reason code

This indicator (TIPS.stat.M9) gives the number of unsettled IP transaction of a selected period and grouped by (i) the common country code of the BIC of the actors and (ii) by Reason Code. The transactions taken into account are the same analysed in paragraph [1.5.8.2.2](#), i.e. the number of transactions with status different from "Settled", regardless of the final status of each transaction (i.e. 'rejected', 'failed' or 'expired'). Moreover, in addition to the country code of the BIC of the actors, all the transactions are classified based on the rejection Reason Code. Consequently, the total number of transactions counted by this indicator and the indicator from paragraph [1.5.8.2.2](#) shall be the same. The only Reason Codes taken in consideration are those generated by TIPS (Internal Reason Code, see [1.5.8.2](#)). Therefore, all the IPs with status unsettled and with a Reason code not generated by TIPS, are grouped into a generic category, namely "External Reason Code".

Table 48 – National Unsettled IP Transaction in SEK per Reason Code

| Transactions per Reason Code | Indicator's reference |
|---|--|
| [Country code].[Reason code] _y | TIPS.stat.M9.[Country code].[Reason code] _y |

1.5.8.2.5 Number of national Recall Requests grouped by reason code

This indicator (TIPS.stat.M10) gives the number of Recall Requests sent on a selected period and grouped by the common country code of the BIC of the actors and by Reason Code. The Recall Requests taken into account are the same analysed in paragraph [1.5.8.2.3](#), i.e. only those sent to the

Beneficiary irrespective if the answer message is negative or positive. Moreover, in addition to the country code of the BIC of the actors, all the Recall Requests are divided by Reason Code.

The Reason codes taken in consideration are the following:

- DUPL: Duplicate Sending
- FRAD: Fraudulent Origin
- TECH: Technical Problem

Table 49 – National Recall Requests per Reason Code

| Recall per Reason Code | Indicator's reference |
|---|---|
| [Country code].[Reason code] _y | TIPS.stat.M10.[Country code].[Reason code] _y |

1.5.8.2.6 Number of national Request for Recall by Originator

This indicator (TIPS.stat.M11) gives the number of Requests for Recall sent on a selected period and grouped by the common country code of the BIC of the banks of the users. The Indicator does not take into consideration the outcome of the Recall, therefore is irrelevant if the answer message is negative or positive. In addition, only the Recall Requests successfully sent to the Beneficiary are taken in consideration for the calculation of the indicator. In order to distinguish a Recall Request from a Request for Recall, the latter shall be defined by the following parameters:

- Index 4.18 'Originator' shall be populated with AT-02 "The name of the Originator".
- Index 4.20 'Reason Code' shall be populated with ISO code "**CUST**" (Requested by Customer).
- Index 4.21 'Reason Proprietary' shall be populated with the proprietary codes "**AM09**" (Wrong amount) and "**AC03**" (Wrong IBAN).

Table 50 – National Requests for Recall

| Requests for Recall per country | Indicator's reference |
|---------------------------------|---|
| [Country code] _x | TIPS.stat.M11.[Country code] _x |

1.5.8.2.7 Overall monthly figures on payment transactions processed by TIPS

This category of indicators provides general information about volume and value of payment transactions²⁶ settled in TIPS for non-Euro currencies:

- Volume and value of national payment transactions settled.

The statistical indicators will provide, for the country code related to the given currency, the settled payment transactions. The relevant figures will be provided to the interested parties by means of an operational report generated on a monthly basis.

²⁶ A payment transaction in this context includes Instant Payments and Positive Recall Answers successfully settled.

1.5.8.2.8 Volume of national payment transactions

This indicator provides the number of payment transactions settled grouped by the country code of the BIC of the Originator Bank.

Table 51 – Number of national settled payment transactions for non-Euro currencies

| Number of settled payment transactions per Originator country | Indicator's reference |
|---|------------------------------|
| [Country code] | TIPS.stat.M12.[Country code] |

1.5.8.2.9 Value of national payment transactions

This indicator provides the total value of payment transactions settled grouped by the country code of the BIC of the Originator Bank.

Table 52 – Value of national settled payment transactions for non-Euro currencies

| Value of settled payment transactions per Originator country | Indicator's reference |
|--|------------------------------|
| [Country code] [Currency code] | TIPS.stat.M13.[Country code] |

1.6. Interactions with other services

This section describes all interactions between TIPS and other services provided by the Eurosystem or other RTGS Systems.

1.6.1. T2 and other RTGS Systems

This sub-section describes all the needed interactions between TIPS and the RTGS Systems.

TIPS is designed to be multi-currency and to provide settlement in euro and non-euro Central Bank Money.

The interactions with the RTGS System aim at informing TIPS about:

- the need for settlement of Liquidity Transfers coming from the RTGS System (see [1.5.3.1 "Inbound Liquidity Transfer"](#));
- the confirmation of a Liquidity Transfer settlement received from TIPS by the RTGS System (see [1.5.3.2 "Outbound Liquidity Transfer"](#));
- the current status of the relevant RTGS System, needed for the validation of Inbound and Outbound Liquidity Transfers;
- the current Business Date of the RTGS System, needed for the reconciliation of Recall Responses, Instant Payments and Liquidity Transfers;

- the moment of change of Business Date in the relevant RTGS System, in order to start the creation of reports and the General Ledger message²⁷;
- the moment to generate and transmit to the relevant RTGS System a snapshot containing the account balances denominated in a specific currency.

TIPS foresees three main interactions with the RTGS Systems covering the above listed information: the Liquidity Transfer management, the closure of the RTGS System (for the maintenance window and the weekend or holidays) and the change of business date of the RTGS System.

Besides these interactions, on an optional basis, an RTGS System may require specific snapshots in connection to particular cut-offs of its operating day.

The following sub-sections provide detailed information on these three main interactions, with specific reference to T2-CLM.

1.6.1.1. Liquidity Transfer management

As described briefly in [1.5.3.1 “Inbound Liquidity Transfer”](#) and [1.5.3.2 “Outbound Liquidity Transfer”](#), the TIPS Service communicates with the relevant RTGS System²⁸ for settling liquidity transfers in a specific currency.

As a general rule, when receiving an Inbound Liquidity Transfer, TIPS accepts the request and settles without checking the status of the RTGS System itself; TIPS takes for granted that the RTGS System requests a liquidity transfer when the system is open.

On the contrary, in the processing of an Outbound Liquidity Transfer, TIPS interacts with the RTGS System as follows:

- TIPS checks that the relevant RTGS System is open and ready for settlement by querying the related instance in the RTGS System table;
- Upon successful settlement, TIPS forwards the liquidity transfer to the RTGS System for the settlement;
- TIPS waits for a confirmation of settlement of the liquidity transfer from the RTGS System; if the confirmation is:
 - o positive, then the transaction is confirmed inside TIPS;
 - o negative, then TIPS performs an automatic reverse of funds;
 - o missing, then TIPS, after a configurable timeframe, raises an alert to trigger a suitable operational procedure.

In any case, the liquidity transfer business case is considered closed only after an explicit confirmation/rejection from the relevant RTGS system.

²⁷ As for the communication with TARGET2, until the go-live of the T2-T2S Consolidation project, the General Ledger will be transferred via the existing flat-file.

²⁸ T2 is the new RTGS System for Euro and the interface is established between TIPS and the T2-CLM component. However, this interface will be enabled only as of the T2-T2S Consolidation go-live.

In case the RTGS System supports the Liquidity Transfer functionality in 'pull' mode, it shall be possible for an authorised RTGS System user to pull liquidity from TIPS back to the RTGS System by sending a liquidity transfer message which is, from TIPS viewpoint, fully equivalent to an Outbound Liquidity Transfer.

The following flow represents the above-described details of the interaction.

Figure 13 – Interaction with RTGS System for Liquidity Transfers

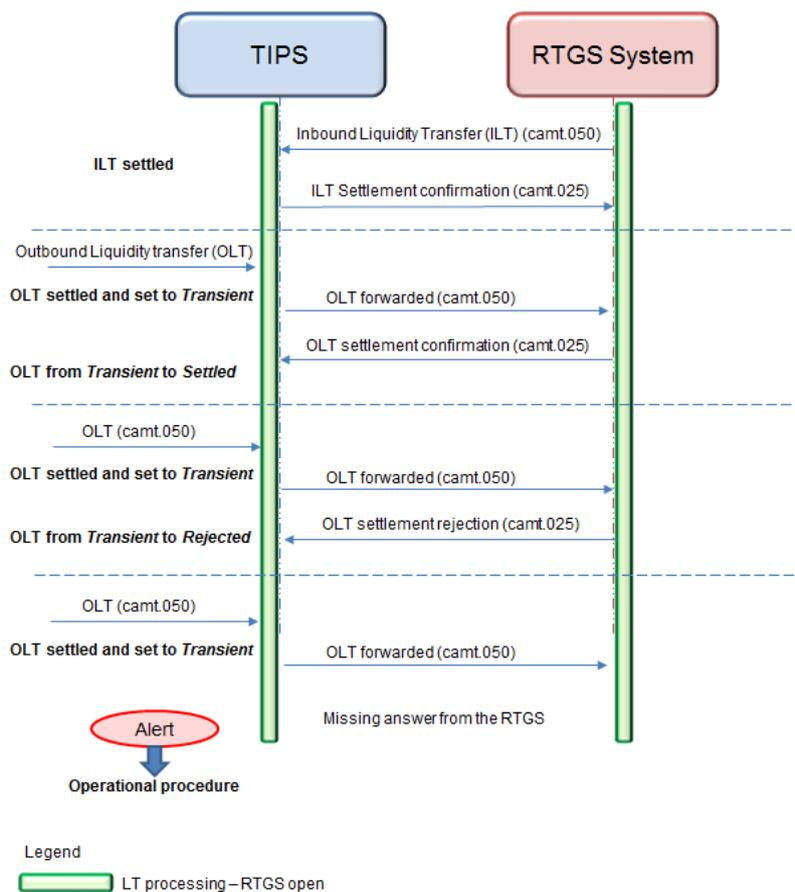

1.6.1.2. Closure of the RTGS System

The RTGS System informs TIPS that it is going to close; in this specific case, the RTGS System is closing for starting the time-window needed for the daily maintenance operations, for the weekend or bank holiday. Similarly, the RTGS System informs TIPS when it is open again for business.

The following flow represents the interaction between TIPS and the RTGS System for the closure and opening of the RTGS System:

Figure 14 – Closure and opening of the RTGS System

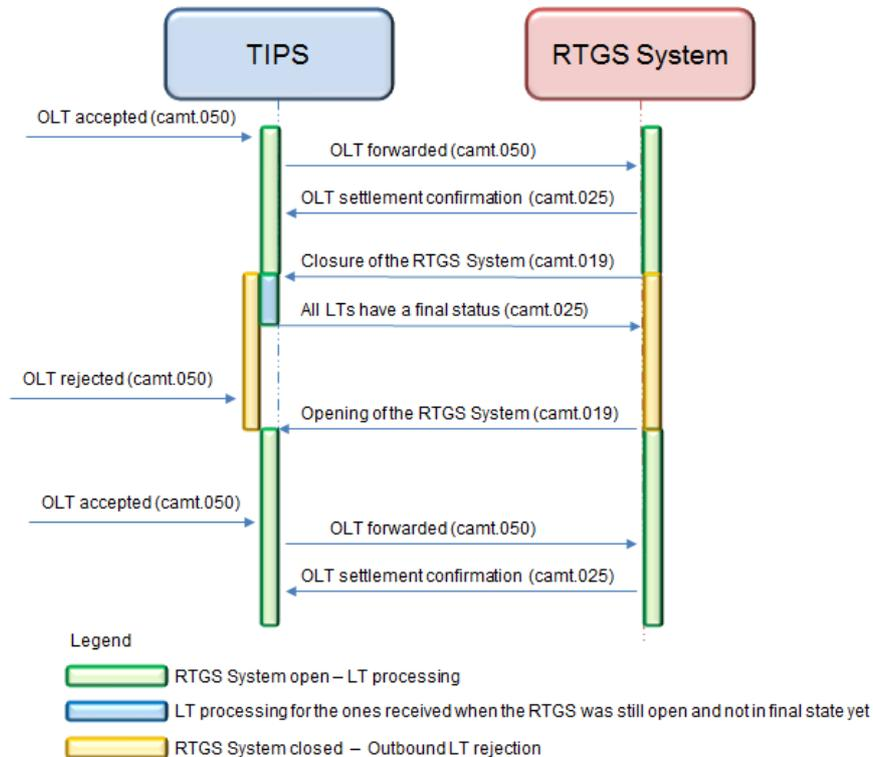

1.6.1.3. Change of business date of the RTGS System

The change of business date of the RTGS System is a key point for TIPS. When informed about the change of business date, TIPS prepares the data for the balances of the business date operations and for the General Ledger message. The designed interaction between TIPS and the relevant RTGS System aims at avoiding any possible discrepancy from TIPS and RTGS System data that may come from the presence of pending Liquidity Transfers in either direction.

The interaction foresees the following steps:

- 1) the RTGS System sends a status message informing TIPS that the cut-off for Liquidity Transfers has been reached;
- 2) any other Outbound Liquidity Transfer message reaching TIPS after the reception of this message must be rejected;
- 3) meanwhile, both TIPS and the RTGS System keep settling the Liquidity Transfers received before the cut-off. The RTGS System keeps sending the related notifications to TIPS, in order to align all the pending transactions. TIPS keeps accepting and processing the Incoming Liquidity Transfers;
- 4) when TIPS receives the confirmation of settlement or the rejection for all the *transient* Liquidity Transfers, it informs the RTGS System that it can proceed;
- 5) when the RTGS System completes the settlement of the pending liquidity transfers on its side and has received the TIPS confirmation to proceed, it sends another status message informing

TIPS that the change of business date can be performed. This status message contains the new business date the RTGS System is moving to. TIPS updates the status and the business date in the RTGS System table and starts the gathering of balances information;

- 6) TIPS takes the snapshot of the balances and sends the General Ledger message to the RTGS System;
- 7) RTGS System sends another status message informing TIPS that Liquidity Transfers can be accepted and processed again.

The following flow represents the steps listed above.

Figure 15 – RTGS System change of business date

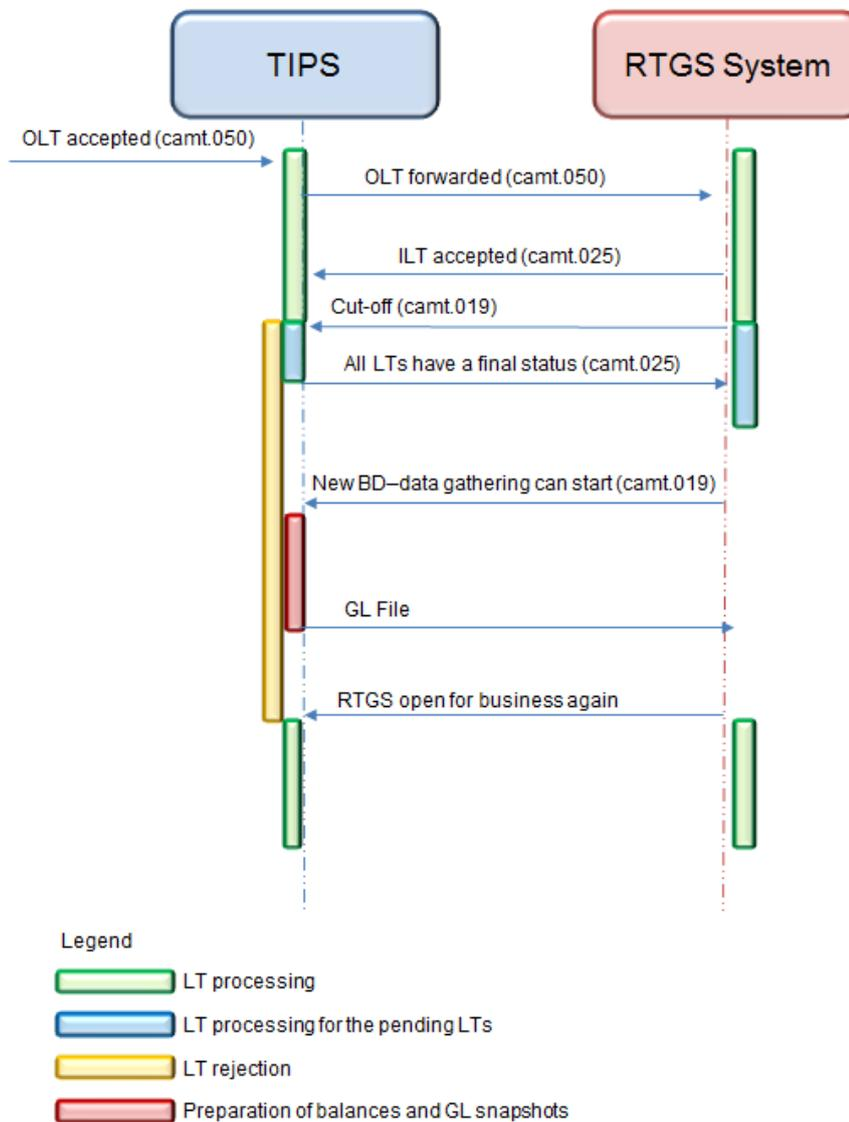

1.6.1.4. TIPS General Ledger

In the specific case of the RTGS System for euro, TIPS provides a general ledger to T2-CLM²⁹ for accounting and Reserve Management purposes. As for non-Euro currencies, TIPS provides the relevant RTGS System with a General Ledger carrying the information related to TIPS Accounts (and transit account) denominated in the given currency for the past business date. In order to convey such a set of information to the relevant RTGS System a [BankToCustomerStatement \(camt.053.001.08\)](#) message is used.

1.6.1.4.1 TIPS General Ledgers production

When T2-CLM starts its End-of-Day process, it sends a [ReturnBusinessDayInformation](#) to TIPS, in order to inform the latter that no more liquidity transfers are accepted by T2-CLM and TIPS starts to finalise all pending liquidity transfers towards T2-CLM.

After the finalisation of the pending liquidity transfers, TIPS confirms it with the delivery of a [Receipt \(camt.025.001.04\)](#) to T2-CLM.

After that and upon request via [ReturnBusinessDayInformation](#) from T2-CLM, TIPS generates and provides a general ledger message based on “TIPS EoD account balances” data related to the business day that just elapsed and that T2-CLM uses to build and provide general ledgers to the Central Banks. Exactly the same communication protocol applies also to the End-of-Day processing related to any other non-Euro RTGS System connected to TIPS.

1.6.1.4.2 Content

The general ledger message contains all accounts in a given currency held in TIPS, including the transit account and the TIPS AS Technical Accounts denominated in the same currency.

TIPS sends to each RTGS System (e.g. T2-CLM for euro) a single not compressed³⁰ camt.053 General Ledger message containing statements without a particular order.

TIPS delivers general ledger data that fulfil the following condition: the sum of all balances of the accounts denominated in a given currency (excluding the transit account for that currency) must be equal to the balance on the transit account for that currency in absolute value.

1.6.1.5. TIPS Snapshot

Similarly to the current End-of-Day mechanism, that leads to the generation and delivery of the TIPS General Ledger towards the RTGS System, the TIPS snapshot function is used to take a consistent picture of the balance available on the accounts of a given currency at a specific moment in time. In

²⁹ Until the Go-Live of Consolidation project TIPS will continue to rely on the existing interface with TARGET2 for the delivery of the General Ledger file during the End-of-Day phase.

³⁰ Compression may apply at network protocol level, if explicitly deemed necessary in the communication with an external RTGS System interacting with TIPS.

order to ensure consistency, there should be no liquidity transfer³¹ “in flight” between TIPS and the RTGS system when the snapshot is taken. For this reason the following workflow between the RTGS system and TIPS shall be implemented.

Figure 16 - Snapshot generation and partial closure status

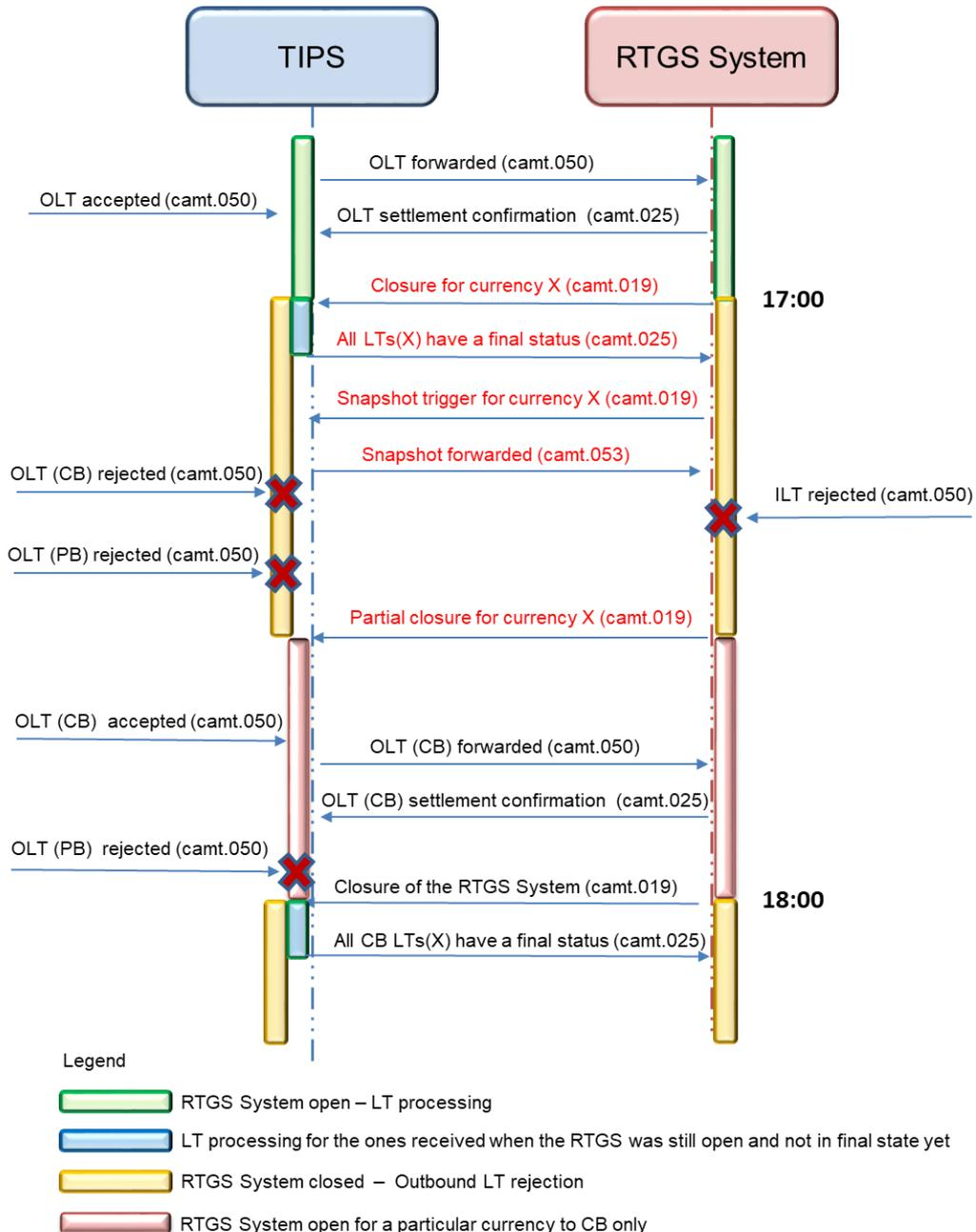

³¹ Denominated in the same currency for which the account balances snapshot is requested.

After the snapshot generation and delivery to the relevant RTGS System, the RTGS System communicates to TIPS the new status of partial closure where only the responsible Central Bank (or the TIPS Operator acting on its behalf) is authorized to instruct Inter-service Liquidity Transfers in a specific currency. All the other settlement currencies active in the system are not impacted by this processing.

1.6.1.5.1 TIPS Snapshot production

When the appropriate currency-specific Snapshot cut-off, configured in the RTGS system operating day, is reached the RTGS system sends a [ReturnBusinessDayInformation](#) to TIPS, in order to inform that for the corresponding currency:

- liquidity transfers from RTGS system to TIPS are no longer accepted by the RTGS system;
- any new outbound liquidity transfers received by TIPS shall be rejected;
- TIPS should finalise all pending liquidity transfers and notify the RTGS system.

After the finalisation of all the pending liquidity transfers, TIPS delivers a [Receipt \(camt.025.001.04\)](#) to the RTGS system.

Once the processing on the pending liquidity transfer in the specific currency is completed in the RTGS system, it delivers a second [ReturnBusinessDayInformation](#) that is used by TIPS as a trigger to generate the [Snapshot message](#) reporting the current balances available on all the TIPS Accounts denominated in the specific currency.

1.6.2. Once the generation is complete, TIPS delivers the snapshot message to the RTGS system. After reception of the snapshot in the RTGS system, a third [ReturnBusinessDayInformation](#) communicates that the status of the RTGS system can be set to 'Partially Closed', i.e. from that moment onward only the Central Bank operating the specific currency can instruct inter-service Outbound Liquidity Transfer. The corresponding block on the inter-service Inbound Liquidity Transfers has to be set up in the RTGS system.
Eurosystem Single Market Infrastructure Gateway

The Eurosystem Single Market Infrastructure Gateway (ESMIG) component provides access to the Market Infrastructure services, including TIPS, in both A2A and U2A channel.

In A2A the ESMIG allows the access from the outside world to TIPS establishing the communication channel between TIPS and the Network Service Providers and checks the A2A message has a valid format (XML schema validation). The NSPs are expected to perform the checks of authentication of the sender and the verification of the signature for the messages received by TIPS. Thus, a message arriving to TIPS must be considered authenticated, properly signed, well-formed after technical validation and sent by a sender recognised as a properly configured one for using the TIPS service.

TIPS performs, then, the authorisation tasks for the sender. The authorisation tasks consist in checking that the access rights configuration of the sender allows it to submit the given request.

In U2A, the ESMIG Identity Access Management component of the ESMIG executes the authentication for U2A users entering the TIPS Graphical User Interface (GUI). Once the user has been successfully

authenticated, the GUI retrieves the granted roles and checks that the requested action is allowed for the user.

For further details, please refer to ESMIG documentation.

1.6.3. Common Reference Data Management

The Common Reference Data Management (CRDM) component provides features that allow duly authorised users to set up, maintain and query all reference data that are shared by multiple services (e.g. T2S, TIPS) for their processing activities.

The access to CRDM is possible in U2A mode (for all functions) and in A2A mode (for a subset of functions) via ESMIG (see section [1.2](#)).

In order to ensure a timely and consistent propagation of common reference data to the relevant services, CRDM implements a publish-subscribe feature allowing each service to receive all the common reference data (and their changes) they require for their processing.

In a nutshell:

- CRDM publishes all changes (in push mode) of common reference data (e.g. creations of new objects, updates of already existing objects);
- Other subscriber services get those changes (in pull mode) and apply them to their Local Reference Data Management component, according to their needs.

Other detailed information can be found in the CRDM documentation.

As far as TIPS is concerned, as anticipated in [1.5.1 “General concepts”](#) and in [1.5.4 “Reference data management”](#), all reference data setup and maintenance operations – other than the immediate changes in the local reference data management – are performed in the CRDM and reference data are then propagated from the CRDM to TIPS either asynchronously on a daily basis or, for specific operations corresponding to the immediate changes available in TIPS (i.e. blocking/unblocking of participants, accounts or CMBs and updates of CMB limits) with immediate effect. The dialogue between CRDM and TIPS envisages three types of interactions:

1. **Daily propagation:** this is the main interaction between CRDM and TIPS. Every CRDM opening day, an ad hoc event triggers the propagation of all TIPS reference data from CRDM to TIPS. The event takes place at 17:00 CET, so to ensure a smooth and complete reference data propagation before TIPS receives the notification that a new business day is starting. The set of reference data that TIPS receives on business day T includes all the active data on the mentioned business date. If an item, propagated on date T, contains a validity date in the future (e.g. T+2), TIPS acquires it during the daily propagation but the item will be available in TIPS only when the validity date is reached.
2. **Contingency propagation:** in case of contingency the TIPS Operator may trigger an ad hoc Daily propagation from CRDM to TIPS. The contingency propagation is a daily propagation triggered

intraday if an immediate change of a set of data (not manageable directly into TIPS) must be performed. In this case, the following steps happen:

- a. All the data eligible for the daily propagation and valid at the moment of the contingency propagation are propagated;
 - b. The daily propagation is performed as scheduled and includes all the active data on the relevant business date.
3. **Immediate propagation:** specific operations, corresponding to the immediate reference data changes available from the TIPS interface, can be carried out in CRDM with immediate effect also in TIPS. If the related attributes are modified directly in TIPS (for example, while CRDM is unavailable) the values in CRDM and TIPS may differ. In such a scenario, it is necessary to restore the alignment between CRDM and TIPS by performing the same change(s) in CRDM as well.

While the values are not aligned, changes to the relevant attributes(s) may only be carried out in TIPS until the CRDM values are set to the same values. During this time, any other operation on the differing values on CRDM side will be rejected. Once the values are aligned on CRDM side, it will once again be possible to carry out any change from CRDM.

The possible CRDM changes triggering immediate propagation in TIPS are:

- Blocking/unblocking of a participant;
- Blocking/unblocking of an account or CMB;
- Update of a CMB limit (and adjustment of the relevant headroom).

The following diagram shows a conceptual overview of the daily propagation between CRDM and TIPS.

Figure 17 – Interaction between CRDM and TIPS³²

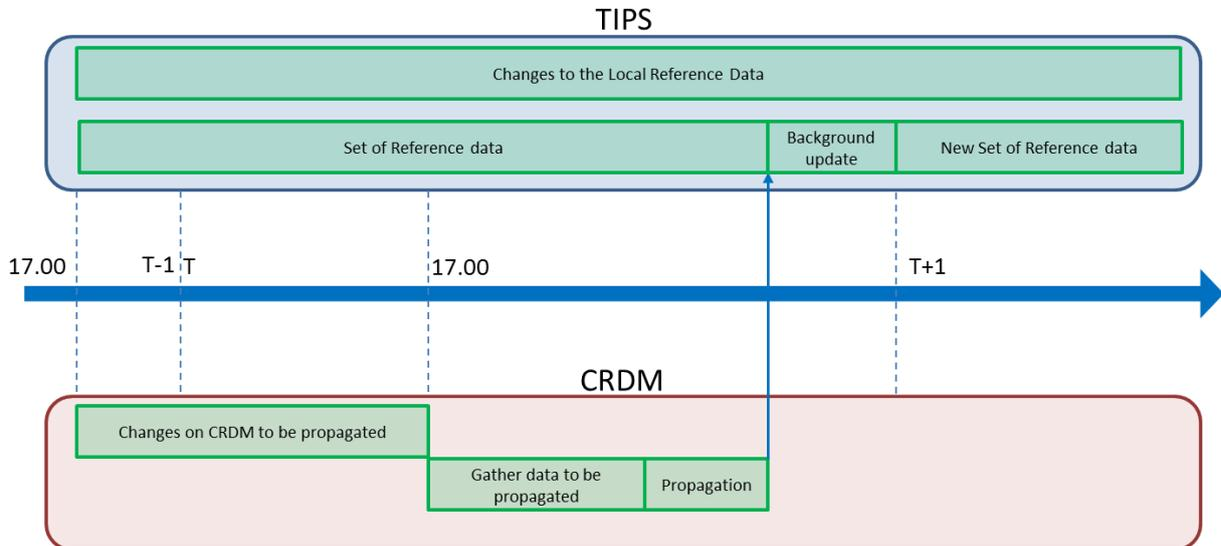

1.6.4. Archiving

The Archiving common component provides features that allow the archiving of legally relevant data for regulatory purposes. Instant Payment transactions, Liquidity Transfers, incoming camt.050 and camt.025 received on the internal interface with T2-CLM, status message data and reference data are archived for a period of exactly ten years. Authentication and security data are archived for a period of exactly three months. Please refer to [1.7.3 “Archiving management”](#) for details on how to access archived data.

TIPS produces every day the needed data of payment transaction and status message to be archived. Please refer to [1.5.6 “Raw Data extraction”](#) for additional details.

1.6.5. Billing

For billing purposes, TIPS relies on the features exposed by BILL common component.

TIPS produces every day the needed data and send them to the Billing common component, as Raw Data. The reader may refer to section [1.5.6 “Raw Data extraction”](#) for additional details.

TIPS is not expected to prepare or send consumption files and invoices to the customers but only to gather the data and provide them to the Billing common component.

³² The cut-off considered for the loading of new data is the business date change received from the RTGS System. Therefore, it is essential that all users with a validity date (such as Cash Accounts) are ready and propagated to TIPS before TIPS receives this business date change signal. For this reason the diagram conventionally marks the beginning of the data change process at 5 p.m.

1.7. Operations and support

1.7.1. Service configuration

TIPS relies on system parameters configured and maintained by the TIPS Operator. The parameters are configured in the CRDM and propagated to TIPS once a day.

The following table includes the exhaustive list of system parameters and their default values.

Table 53 – System Parameters

| Parameter name | Description | Default value |
|---------------------------------------|---|---------------|
| Retention Period | The retention period ³³ for transactional data (i.e. Instant Payment transactions, recall, liquidity transfers) expressed in calendar days. This parameter is used also for detecting the timeframe within which two instructions with the same Originator BIC (field AT-D002 in DS-02) and Originator reference (field AT-T054 in DS-02) must be considered as duplicates. The parameter defines the maximum period of time for which the historical data can be accessed either via TIPS GUI or via A2A queries. The retention period starts by the time the transactional data is received by the system. | 5 |
| SCT ^{Inst} Timestamp Timeout | The time window foreseen in SCT ^{Inst} scheme after which an Instant Payment transaction must be rejected due to timeout. This parameter is expressed in milliseconds. | 20,000 |
| Originator Side Offset | It is a configurable offset for evaluation of the SCT ^{Inst} Timestamp Timeout applied to the reception of the message sent by Originator Participant or Instructing Party acting on behalf of the Originator Participant or a Reachable Party. This parameter can only have values smaller than or equal to zero. An Instant Payment Transaction sent by the Originator Participant or Instructing Party acting on behalf of the Originator Participant or a Reachable Party can be rejected due to timeout in the event that the message is submitted to TIPS with a timestamp (the SCT ^{Inst} timestamp, field AT-T056 in DS-02) that is already past the timeout window (SCT^{Inst} Timestamp Timeout + Originator Side Offset). This parameter is expressed in milliseconds. | -1,000 |
| Beneficiary Side Offset | It is a configurable offset for evaluation of the SCT ^{Inst} Timestamp Timeout applied to the reception of the message sent by Beneficiary Participant or Instructing Party acting on behalf of the Beneficiary Participant or a Reachable Party. Rejections due to timeout can occur in the event that the Beneficiary Reply message is not received or if it is submitted to TIPS with a timestamp (the SCT ^{Inst} timestamp, field AT-T056 in DS-02) that is already past the timeout window (SCT^{Inst} Timestamp Timeout + Beneficiary Side Offset). This parameter is expressed in milliseconds. | 1,000 |

³³ TIPS maintains a list of received messages for its own internal consistency. For this reason, based on this buffer, TIPS could still detect the duplicate even after the retention period.

| Parameter name | Description | Default value |
|--|---|---|
| Sweeping Timeout | <p>The time window after which the sweeping daemon looks for pending payments for which:</p> <ul style="list-style-type: none"> (i) a valid and timely confirmation from the Beneficiary Participant has not been received yet and (ii) the SCT^{Inst} Timestamp Timeout is elapsed. <p>The value can impact on the performances of the system and must be changed only after green light received by the technical support. The parameter is expressed in seconds.</p> | 5 |
| Maximum Amount | Maximum amount – defined for each settlement currency – which can be transferred by a single Instant Payment transaction. The parameter must allow an “unlimited” value. | <p><i>Unlimited (for Euro)</i></p> <p><i>Unlimited (for SEK)</i></p> <p><i>7,500,000.00 (for DKK)</i></p> |
| Acceptable Future Time Window | The acceptable time range for future timestamps. The rejection of an Instant Payment transaction is triggered if the received timestamp is greater than the acceptable time window (current timestamp plus this time window value). It is expressed in milliseconds. | 100 |
| Investigation Offset | Configurable offset foreseen in SCT ^{Inst} scheme. An Investigation request can be accepted only if it is received after SCT^{Inst} Timestamp Timeout of the Instant Payment transaction + Investigation Offset. This parameter is expressed in milliseconds. | 5,000 |
| Investigation Offset (non-Euro currency) | Configurable offset foreseen in the non-Euro currency scheme. An Investigation request can be accepted only if it is received after Timestamp Timeout of the Instant Payment transaction + Investigation Offset (non-Euro currency). This parameter is expressed in milliseconds and can hold a negative value. | -10,000 |
| RTGS Alert | Configurable timeframe after which the TIPS Operator is notified about a missing answer from the RTGS System to an Outbound liquidity transfer. The parameter value is expressed in minutes. | 15 |

In order to properly configure the parameters, the following diagram depicts the meaning of SCT^{Inst} Timestamp Timeout, Originator Side Offset, Beneficiary Side Offset and Investigation Offset in the timeout scenario.

Figure 18 – Timeout parameters for SCT Inst

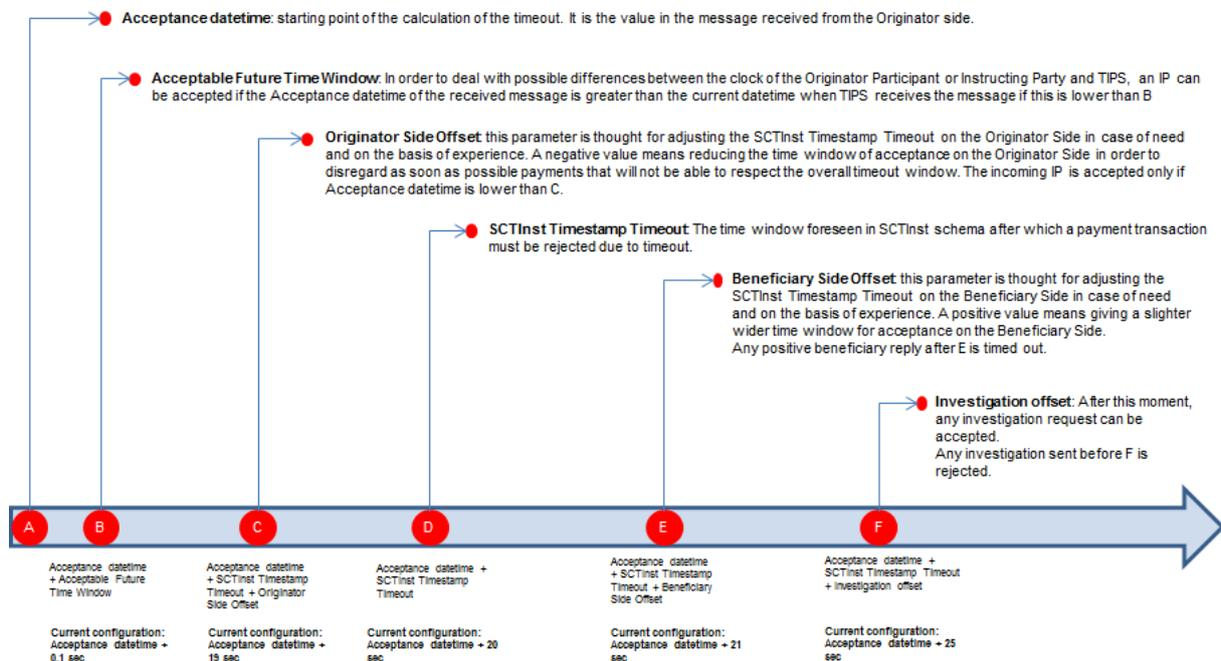

For UTC clock synchronization, TIPS uses an NTP stratum-1 server based on GPS transmissions.

1.7.2. Business and operations monitoring

The Business and operations monitoring integrates information coming from different sources in order to monitor the business and operational status of the service, to detect possible problems in real-time or to proactively recognise a possible deterioration of the service performance and to provide up-to-date information for crisis management scenarios.

Business and operations monitoring gives the TIPS Operator the possibility to perform a real-time supervision of the platform in terms of:

- Performance;
- Transactions transit and response times;
- Ongoing fulfilment of SLA commitments and expectations;
- Volumes and values exchanged;
- Actors activity on the system;
- Usage of liquidity;
- Hardware and software problems.

The goal is to allow an early detection of possible anomalies through the continuous comparison of reported data with standard patterns. Besides that, the data can be used to improve the service behaviour or its usage through a better understanding of the relevant dynamics.

The Business and operations monitoring application process extracts, merges and organizes the data in forms of tables, grids and graphs to ensure both the depth of the underlying information and its prompt usability.

In order to exclude any even remote impact on the service performances, the Business and operations monitoring application makes use of a different set of data which are replicated from the original ones.

TIPS provides the TIPS Operator also with a tool for the detection in real-time of functional or operational problems, called Technical Monitoring. It allows for the detection of hardware and software problems via real-time monitoring of the technical components involved in the processing, including the network connections.

Business and operations monitoring interfaces are available in U2A mode only.

The TIPS Operator is also provided with a contingency tool in order to inject messages to act on the system in case of need. For example, this tool allows to update the RTGS System Status table simulating the receipt of a [ReturnBusinessDayInformation](#) message from the relevant RTGS System or the sending of a [Receipt \(camt.025.001.04\)](#) message in order to finalise a pending liquidity transfer.

The list of possible messages the TIPS Operator can inject is:

- [ReturnBusinessDayInformation](#);
- [LiquidityCreditTransfer](#);
- [Receipt \(camt.025.001.04\)](#);
- [AccountExcludedMandateMaintenanceRequest](#);
- [ModifyLimit \(camt.011.001.07\)](#);
- [PartyModificationRequest](#).

1.7.3. Archiving management

TIPS provides raw data to the Archiving shared service on a daily basis, as described in [1.5.6.1 "Raw data for Archiving"](#).

The TIPS Operator is responsible for the retrieval of the archived information from LeA upon Central Bank request. The Central Bank can also request the retrieval of archived data on behalf of one of their TIPS Actors.

TIPS Operator is allowed to retrieve archived Instant Payment transaction, Liquidity Transfers, incoming camt.050 and camt.025 messages received on the internal interface with T2-CLM, status message data and reference data for a period of exactly ten years. Moreover, TIPS Operator shall be able to retrieve archived authentication and security data for a period of exactly three months.

2. Dialogue between TIPS and TIPS Actors

This section aims at describing the interactions in A2A mode between TIPS Actors and TIPS.

In the first sub-section, it describes the general communication process: what is the general process when a message arrives to TIPS and which functions of TIPS are interested in the process.

The following sub-sections describe the interactions the TIPS Actors can have with TIPS. These sub-sections describe the scenarios the user can go through, specifying:

- The involved actors;
- The involved messages;
- The conditions of executions and the possible returned errors.

In such a way, this section aims both to describe the process for the TIPS Actors, guiding them in the use of the involved messages, and to give the necessary details needed for implementing the software on their side.

When a message is referenced, it is linked to the relevant section within chapter [3 - "Catalogue of messages"](#) where to find the detailed information.

2.1. Message routing

In A2A mode, TIPS Actors and TIPS can exchange messages and files by means of two types of transfer services:

- The real-time message, which requires that all the interested actors are available at the same time;
- The store-and-forward file transfer, which enables TIPS to transmit messages or files even when the receiver is not available.

The following table shows how the main types TIPS data exchanges are mapped against the technical features of the different network services for inbound and outbound communication.

Table 54 – Network services

| Data Exchange | Inbound transfer services | Outbound transfer services |
|------------------------------|---------------------------|----------------------------|
| Instant Payment transactions | Instant messaging | Instant messaging |
| Liquidity transfers | Instant messaging | Instant messaging |
| Investigations | Instant messaging | Instant messaging |
| Queries | Instant messaging | Instant messaging |
| Recall | Instant messaging | Instant messaging |

| Data Exchange | Inbound transfer services | Outbound transfer services |
|-----------------------------|---------------------------|---|
| Notifications | n/a | Instant messaging |
| Reports (push) | n/a | File-based, store-and-forward |
| Raw data and General Ledger | n/a | File transfer to T2-CLM |
| General Ledger message | n/a | Instant messaging to any external RTGS System |

The File-based store-and-forward network service is used only by TIPS and only to send outbound Reports.

As described in the section [1.2](#), TIPS allows Participants and Instructing Parties to use multiple distinguished names (DNs) to communicate with the network service.

Thanks to the functionalities available in the CRDM, a TIPS actor with the suitable permissions is able to set up routing configurations, allowing TIPS to accept messages coming from specified DN and to route a predefined set of outbound communication to a specified DN. A routing configuration is a link between a Participant or Reachable Party's BIC and a distinguished name.

Depending on the direction of communication, we can distinguish between:

- Inbound messages: TIPS shall allow a many-to-many relation between sender distinguished names and Parties, meaning that the same Instructing Party can play its role for many Parties and that a Participant or Reachable Party can authorise many Instructing Parties to act on its behalf. Moreover, it is possible to authorise a specific Instructing Party DN to act on behalf of a specific BIC, for instance for instructing Instant Payments. The couple (DN, BIC) is stored in the "Inbound DN-BIC Routing" table.
- Outbound messages: TIPS shall ensure that there is a many-to-one relation between Beneficiary Participant or Reachable Party and receiver distinguished names, meaning that any given Beneficiary Participant BIC may be linked to one and only one Distinguished Name for the receipt of instant payment messages. The couple (DN, BIC) is stored in the "Outbound DN-BIC Routing" table. In addition, it is possible to configure separate Distinguished Names per TIPS Participant as "Party Technical Addresses"; one for the receipt of notifications relevant for account owners, such as floor/ceiling notifications, and one or more for the receipt of reports. The types of messages to be routed to each Party Technical Address can be configured through a Routing configuration.

In the following it will be clarified in what case and under what condition TIPS uses those links to manage input and output messages and in which other conditions it manages messages without querying them. TIPS uses the routing information contained in the Inbound DN-BIC Routing table to check authorisation of instant payment input messages: only messages with the couple DN-BIC for which an entry in the Inbound DN-BIC Routing table exists are accepted by TIPS.

For other message types, such as outbound liquidity transfers or queries, TIPS checks that the requestor DN is defined as an Instructing Party for the relevant TIPS Participant (such as the owner of the account on which the liquidity transfer is being executed).

Regarding how to route outbound communication, the general behaviour of TIPS is as follows:

- When TIPS receives an input message x from a TIPS actor a , it stores the DN of the message sender and uses it to send or to forward any kind of communication regarding a and the transaction represented by x .
- In case x concerns another TIPS Actor (b) assuming a different role i.e. the Beneficiary of an Instant Payment or the Assignee of a Recall, TIPS cannot infer its DN from the message coming from a . For this reason, TIPS retrieves the DN z of b based on the configured data. TIPS relates b to the DN z throughout the entire transaction life-cycle.

Therefore, as a general rule, when TIPS cannot identify an actor DN from an input message or in case of push-mode communication, TIPS uses the Outbound DN-BIC routing table or the Party Technical Address (in combination with the Routing Configuration) to find the correct outbound DN.

Based on the transaction types and on the role assumed by the Actors, the following table specifies the type of outbound routing used for the different data exchange scenarios.

Table 55 – Outbound routing

| Data Exchange | Outbound DN-BIC | Party Technical Address + Routing | Sender DN |
|--|-----------------|-----------------------------------|-----------|
| Instant Payment transactions answer (Originator role) | x | x | ✓ |
| Instant Payment transactions answer (Beneficiary role) | ✓ | x | x |
| Instant Payment transactions answer (SIP settlement model) when Single Instructing Party is acting for both Originator and Beneficiary | x | x | ✓ |
| Timeout message generated by TIPS | ✓ | x | ✓ |
| Liquidity transfers receipts | x | x | ✓ |
| Investigation answers | x | x | ✓ |
| Query answers | x | x | ✓ |
| Recall Responses (Assigner role) | x | x | ✓ |
| Recall Responses (Assignee role) | ✓ | x | x |
| Error on input messages | x | x | ✓ |
| Reference data response messages | x | x | ✓ |
| Notifications | x | ✓ | x |
| Reports | x | ✓ | x |

Entering in detail on the single message:

- "Outbound DN-BIC Routing" table is used to select the correct DN for a TIPS actor identified by a BIC, in case of:
 - o Messages forwarded to other TIPS Actors, i.e.
 - [FItoFICustomerCreditTransfer](#) forwarded to the Beneficiary;
 - [FItoFIPaymentCancellationRequest](#) forwarded to the Recall Assignee;
 - [ResolutionOfInvestigation](#) forwarded to the Recall Assigner;
 - [FItoFIPaymentStatusRequest](#) forwarded to the Recall Assignee;
 - [PaymentReturn](#) forwarded to the Recall Assigner (Beneficiary).
 - o [FItoFIPaymentStatusReport](#) sent to the Beneficiary in case of Timeout;
- "Party Technical Address" is used in combination with the "Routing Configuration" for the specific message to select the correct DN for a TIPS actor in case of:
 - o Notifications, for the Owner of the Account/CMB, i.e.
 - Floor/Ceiling notification on Account/CMB;

- Credit/Debit notification on Account.
- Reports sent to the subscribing TIPS actors.
- The sender DN is used to answer to an input message in case of:
 - Error messages generated by TIPS as result of a failed check on an input message;
 - Every other answer, i.e.:
 - [FIToFIPaymentStatusReport](#) sent to the Originator of an Instant Payment transaction;
 - [FIToFIPaymentStatusReport](#) as result of an investigation;
 - [Receipt](#) of a Liquidity transfer order;
 - Answers to a Query:
 - [ReturnAccount](#).
 - Reference data answer messages:
 - [PartyStatusAdvice](#);
 - [AccountRequestAcknowledgement](#);
 - [AccountRequestRejection](#);
 - [Receipt](#).

The different multiplicity of the DN-BIC correspondence between the Inbound and the Outbound DN-BIC routing table and the absence of constraints between the two types of configuration, makes it possible to setup a given Participant or Reachable Party BIC in the CRDM with different and disjoint sets of DNs for its Instructing Parties: one set (with cardinality greater than or equal to one) for the inbound routing and another one (with cardinality equal to one) for the outbound routing. This means that a BIC can be configured to send message with an Instructing Party (DN) but to receive messages with a different DN.

For example, a BIC *z* could be linked to the DN *a* in the Inbound DN-BIC routing table and with the DN *b* in the outbound DN-BIC routing table, with *a* being different from *b*. This would imply that the TIPS actor identified by BIC *z*, when acting as Originator of an Instant Payment transaction, can send messages to TIPS with *a* and receive the related answers from TIPS to *a*. The same actor, when playing the role of the Beneficiary of an Instant Payment transaction, receives messages from TIPS to *b* but has to send its answers to TIPS with *a*.

The Instant Payment transaction steps tables of the Chapter [2 – “Dialogue between TIPS and TIPS Actors”](#) specify the DN considered by TIPS for each step, message and actor’s role.

2.2. Instant Payment transaction

2.2.1. Instant Payment (SCT^{Inst} scheme)

This section focuses on the settlement of Instant Payment transactions in the SCT^{Inst} scheme, describing the full scenario and the related steps.

The introductory part of the section presents the general flow, including all the steps.

A sub-section dedicated to the timeout follows, describing the specific case of timeout occurring when a Beneficiary reply is missing.

All the remaining sub-sections contain examples of the possible scenarios, starting from a successful one and detailing possible failure scenarios. Each example shows the relevant messages and how the main fields are filled.

The Instant Payment transaction process covers the scenarios in which an Originator Participant, Ancillary System or Instructing Party acting on behalf of the Originator Participant or a Reachable Party instructs TIPS in order to immediately transfer funds to the account of a Beneficiary Participant. The involved actors are:

- The Originator Participant, Ancillary System or Instructing Party acting on behalf of the Originator Participant or a Reachable Party, starting the scenario;
- The Beneficiary Participant, Ancillary System or Instructing Party acting on behalf of the Beneficiary Participant or a Reachable Party, receiving the request and either confirming or rejecting the payment.

The involved messages are:

- The [FItoFICustomerCreditTransfer](#) message sent by the Originator Participant, Ancillary System or Instructing Party acting on behalf of the Participant/Reachable Party in order to (i) instruct the payment, (ii) to reserve the corresponding amount and (iii) to inform the Beneficiary Participant, Ancillary System or Instructing Party acting on behalf of the Participant/Reachable Party about the transaction received;
- The [FIToFIPaymentStatusReport](#) message sent (i) by the Beneficiary Participant, Ancillary System or Instructing Party acting on behalf of the Participant/Reachable Party to TIPS to either accept or reject the Instant Payment transaction, or (ii) by TIPS to inform the actors about the result of the settlement (i.e. settled, rejected, timed out);
- The [ReturnAccount](#) message that can be sent, on optional basis, by TIPS to the Creditor Account Owner and/or the Debtor Account Owner. The message is sent by TIPS if (i) the owner of the account (or CMB) enables the floor and ceiling notifications and (ii) the configured threshold is breached.

All the described scenarios are triggered under the assumption that the technical validation, check of mandatory fields and authentication of the user have already been successfully performed by ESMIG.

It is important to keep in mind that when the Debtor or Creditor BIC contains a BIC8 instead of a BIC11, the message is accepted and the string is completed by appending “XXX” at the end of the BIC8 for further processing. All the steps are described considering BIC11 only.

Below is the diagram describing the process and the involved actors. The details of the steps are described in the following [Table 56 – Instant Payment transaction steps](#).

Figure 19 – Instant Payment transaction flow

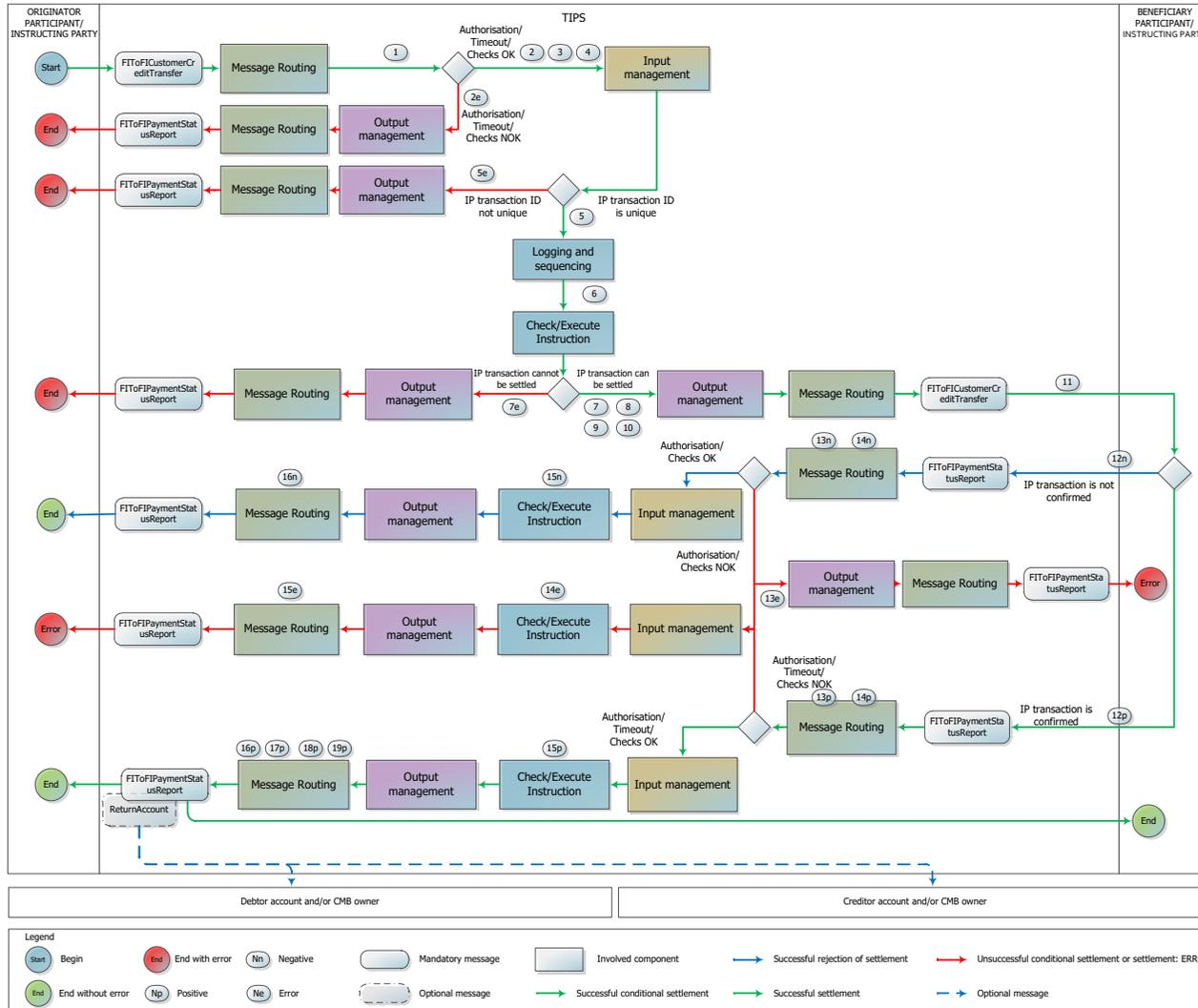

Table 56 – Instant Payment transaction steps

| Step | Involved messages | Involved actors | Description |
|------|--|---|---|
| 1 | FItoFICustomerCreditTransfer | Originator Participant, Ancillary System or Instructing Party as Sender TIPS as receiver | TIPS receives an Instant Payment transaction from the Originator Participant or Instructing Party acting on behalf of the Originator Participant, Ancillary System or a Reachable Party starting the conditional settlement phase of the transaction. Technical validation, check of mandatory fields and authentication checks have already been successfully executed. The timeout for the Instant Payment transaction has not expired. TIPS logs the instruction as “ <i>Received</i> ”. |
| 2 | | TIPS | TIPS successfully executes the checks: <ul style="list-style-type: none"> - Access Rights check; - Timeout Check - Originator Side; - Maximum Amount not Exceeded; - Originator Account or CMB existence; - Instructing Party authorised; - Beneficiary correctly configured; - Beneficiary Account or CMB existence. <p>See 4.1- Business Rules for details.</p> |
| 2e | FIToFIPaymentStatusReport | TIPS as sender Originator Participant, Ancillary System or Instructing Party as receiver | TIPS unsuccessfully executes one of the checks listed in step 2 . At the first negative check the system stops and sends a message to the Originator Participant, Ancillary System or Instructing Party acting on behalf of the Originator Participant or a Reachable Party – same DN of the Sender in step 1 – containing the proper error code. If the failed check is “ Timeout Check - Originator Side ”, the status of the transaction is set to “ <i>Expired</i> ”; in all the other cases, the status is set to “ <i>Failed</i> ”. |

| Step | Involved messages | Involved actors | Description |
|------|-------------------|-----------------|---|
| 3 | | TIPS | <p>TIPS infers the account to be debited from the configured accounts information, the Originator Participant BIC and the currency of the Instant Payment transaction.</p> <p>In details TIPS checks that:</p> <ul style="list-style-type: none"> (i) an account, with either type "TIPS Account" or "TIPS AS Technical Account" exists, (ii) it is linked to the Originator Participant (field "Originator BIC") as authorised user, (iii) and it is denominated in the same currency as the one defined in the Settlement Amount. <p>- If the check does not return any account, TIPS looks for a CMB linked to the Originator Participant (field "Originator BIC") as authorised user; - TIPS selects the account linked to the CMB; the account related to the CMB must be denominated in the same currency as the one defined in the Settlement Amount.</p> <p>From now on, the selected account is referred to as "Originator Account" and the possible CMB as "Debiting CMB".</p> |
| 4 | | TIPS | <p>TIPS infers the account to be credited from the configured accounts information, the Beneficiary Participant BIC and the currency of the Instant Payment transaction.</p> <p>In details TIPS checks that:</p> <ul style="list-style-type: none"> (i) an account, with either type "TIPS Account" or "TIPS AS Technical Account" exists, (ii) it is linked to the Beneficiary Participant (field "Beneficiary BIC") as authorised user, (iii) and has a currency equal to the one defined in the Settlement Amount. <p>- If the check does not return any account, TIPS looks for a CMB linked to the Beneficiary Participant (field "Beneficiary BIC") as authorised user; - TIPS selects the account linked to the CMB; the account related to the CMB must be denominated in the same currency as the one defined in the Settlement Amount.</p> <p>From now on, the selected account is referred to as "Beneficiary Account" and the possible CMB as "Crediting CMB".</p> |

| Step | Involved messages | Involved actors | Description |
|------|---|---|--|
| 5 | | TIPS | TIPS successfully executes the check: - Duplicate check ; See 4.1 - Business Rules for details. |
| 5e | FIToFIPaymentStatusReport | TIPS as sender Originator Participant, Ancillary System or Instructing Party as receiver | TIPS unsuccessfully executes the check listed in step 5 . If the check is unsuccessful the system stops and sends a message to the Originator Participant, Ancillary System or Instructing Party acting on behalf of the Originator Participant or a Reachable Party – same DN of the Sender – containing the proper error code. The transaction is set to "Failed" status. See 4.1 - Business Rules for details. |
| 6 | | TIPS | TIPS sends it to the Check and Execute Instruction process. TIPS sets the transaction status to "Validated". |
| 7 | | TIPS | TIPS successfully executes the checks: - Originator Account/CMB not blocked ; - Beneficiary Account/CMB not blocked ; - Available amount not exceeded ; See 4.1 - Business Rules for details. |
| 7e | FIToFIPaymentStatusReport | TIPS as sender Originator Participant, Ancillary System or Instructing Party as receiver | TIPS unsuccessfully executes the checks listed in step 7 . At the first negative check the system stops and sends a message to the Originator Participant, Ancillary System or Instructing Party acting on behalf of the Originator Participant or a Reachable Party – same DN of the Sender in step 1 – containing the proper error code. The transaction is set to "Failed" status. See 4.1 - Business Rules for details. |
| 8 | | TIPS | The DN of the Sender in step 1 is saved as information related to the transaction. From now on, this DN is referred to as "Originator DN". |

| Step | Involved messages | Involved actors | Description |
|------|--|--|--|
| 9 | | TIPS | TIPS reserves funds in the Originator account. The full amount is reserved as Reserved Balance in the Cash Balance. TIPS sets the transaction status to "Reserved". If a Debiting CMB is involved, the system decreases its headroom by the same amount. After this moment, the settlement attempt is agreed and can either be confirmed or rejected by the counterpart or fail for a missing answer. The reserved amount cannot be considered for other payments. |
| 10 | | TIPS | The DN of the beneficiary is identified in the "Outbound DN-BIC Routing" mapping table from the field Creditor Agent. From now on, this DN is referred to as "Beneficiary DN". |
| 11 | FItoFICustomerCreditTransfer | TIPS as sender Beneficiary Participant, Ancillary System or Instructing Party as receiver | TIPS forwards the received Instant Payment transaction to the Beneficiary DN. |
| 12p | FIToFIPaymentStatusReport | Beneficiary Participant, Ancillary System or Instructing Party as sender TIPS as receiver | The Beneficiary Participant, Ancillary System or Instructing Party acting on behalf of the Beneficiary Participant or a Reachable Party starts the settlement phase of the transaction by sending a positive payment status report that is successfully delivered to TIPS. Technical validation, check of mandatory fields and authentication checks have already been successfully executed. |
| 13p | | TIPS | TIPS successfully executes the checks: <ul style="list-style-type: none"> - Access Rights check; - Instructing Party authorised – creditor side; - Pending transaction existing; - Timeout Check - Beneficiary Side. See 4.1- Business Rules for details. |
| 13e | FIToFIPaymentStatusReport | TIPS as sender Beneficiary Participant, Ancillary System or Instructing Party as receiver | TIPS unsuccessfully executes the checks listed in step 13p . At the first negative check the system stops and sends a message to the Beneficiary Participant, Ancillary System or Instructing Party acting on behalf of the Beneficiary Participant or a Reachable Party (DN of the sender of the message) containing the proper error code. See 4.1- Business Rules for details. |

| Step | Involved messages | Involved actors | Description |
|------|---|--|---|
| 14e | | TIPS | <p>If the pending transaction exists, TIPS retrieves it using the Transaction ID. The reserved amount is released in the involved Originator Account and the possibly involved Debiting CMB is increased of the same amount. TIPS always releases the reserved transactions even if the involved account or CMB have been blocked in the meantime.</p> <p>The transaction is set to "<i>Failed</i>" status.</p> |
| 15e | FIToFIPaymentStatusReport | TIPS as sender Originator Participant, Ancillary System or Instructing Party as receiver | TIPS sends a message to the Originator Participant, Ancillary System or Instructing Party acting on behalf of the Originator Participant or a Reachable Party – same DN of the Sender in step 1 – containing the proper error code. |
| 14p | | TIPS | TIPS identifies the transaction using the Transaction ID. The transaction Id is related to a transaction that exists in TIPS and still in " <i>Reserved</i> " status. |
| 15p | | TIPS | <p>TIPS retrieves the reserved transaction and confirms it. The amount is considered settled and the transaction is set to "<i>Settled</i>" status. The reserved amount of the Originator Account is decreased by the amount of the corresponding settled transaction.</p> <p>The same positive amount is added to the Beneficiary Account. If a Crediting CMB is involved, TIPS increases its headroom by the same amount. TIPS always executes the reserved transactions even though the involved accounts (or CMBs) have been blocked in the meantime.</p> |
| 16p | FIToFIPaymentStatusReport | TIPS as sender Originator Participant, Ancillary System or Instructing Party as receiver | TIPS forwards the received Payment status report to the Originator DN. |
| 17p | FIToFIPaymentStatusReport | TIPS as sender Beneficiary Participant, Ancillary System or Instructing Party as receiver | TIPS generates a positive Payment status report and sends it to the Beneficiary DN. The FIToFIPaymentStatusReport contains the Transaction ID and Originator BIC of the transaction. |

| Step | Involved messages | Involved actors | Description |
|------|---|--|---|
| 18p | ReturnAccount | TIPS as sender Debited Account and/or CMB Owner | TIPS checks the "Floor notification amount" configured for the involved Originator account or Debiting CMB. After settlement confirmation, if the account balance and/or the CMB headroom crosses the threshold configured as "floor notification amount", TIPS sends a ReturnAccount to the account and/or CMB owners involved in the transaction. The message is sent to the default DN of the Account Owner and/or CMB Owner. The message contains the Originator account number or the Debiting CMB number |
| 19p | ReturnAccount | TIPS as sender Credited Account and/or CMB Owner | TIPS checks the "Ceiling notification amount" configured for the involved Beneficiary account or Crediting CMB. After settlement confirmation, if the account balance and/or the CMB headroom crosses the threshold configured as "ceiling notification amount", TIPS sends a ReturnAccount to the account and/or CMB owners involved in the transaction. The message is sent to the default DN of the Account Owner and/or CMB Owner. The message contains the Beneficiary account number or the Crediting CMB number |
| 12n | FIToFIPaymentStatusReport | Beneficiary Participant, Ancillary System or Instructing Party as sender TIPS as receiver | The Beneficiary Participant, Ancillary System or Instructing Party acting on behalf of the Beneficiary Participant or a Reachable Party triggers the settlement phase of the transaction sending a negative payment status report that is successfully delivered to TIPS. In this scenario the settlement phase will end up with a rejection of the Instant Payment transaction and the un-reservation of corresponding funds. Technical validation, check of mandatory fields and authentication checks have already been successfully executed. |
| 13n | | TIPS | TIPS successfully executes the checks: - Access Rights check ; - Instructing Party authorised – creditor side ; - Pending transaction existing . See 4.1- Business Rules for details. |

| Step | Involved messages | Involved actors | Description |
|------|---|--|--|
| 13e | | TIPS as sender Beneficiary Participant, Ancillary System or Instructing Party as receiver | TIPS unsuccessfully executes the checks at step 13n . At the first negative check the system stops and sends a message to the Beneficiary Participant, Ancillary System or Instructing Party acting on behalf of the Beneficiary Participant or a Reachable Party (DN of the sender of the message) containing the proper error code. See 4.1- Business Rules for details. |
| 14e | | TIPS | If the pending transaction exists, TIPS retrieves it using the Transaction ID. The reserved amount is released in the involved Originator account and the possibly involved Debiting CMB is increased of the same amount. TIPS always releases the reserved transactions even if the involved account or CMB have been blocked in the meantime. The transaction is set to " <i>Failed</i> " status. |
| 15e | FIToFIPaymentStatusReport | TIPS as sender Originator Participant, Ancillary System or Instructing Party as receiver | TIPS sends a message to the Originator Participant, Ancillary System or Instructing Party acting on behalf of the Originator Participant or a Reachable Party – same DN of the Sender in step 1 – containing the proper error code. |
| 14n | | TIPS | TIPS identifies the transaction using the Transaction ID. The Transaction ID is related to a transaction existing in TIPS and still in " <i>Reserved</i> " status. |
| 15n | | TIPS | TIPS retrieves the Instant Payment transaction to be rejected and releases it. The reserved amount is released in the involved Originator Account and the possibly involved Debiting CMB is increased of the same amount. TIPS always releases the reserved transactions even if the involved account or CMB have been blocked in the meantime. The transaction is set to " <i>Rejected</i> " status. |
| 16n | FIToFIPaymentStatusReport | TIPS as sender Originator Participant, Ancillary System or Instructing Party as receiver | TIPS forwards the received Payment status report to the Originator DN. |

2.2.1.1. Timeout scenario: missing/delayed Beneficiary-side answer

This sub-section describes the specific scenario of TIPS not receiving a Beneficiary-side answer or receiving it later than allowed.

This scenario assumes that TIPS has successfully executed the conditional settlement phase of an Instant Payment.

A specific software component (Sweeping service) is always acting in background taking care of all the orphan payments – an orphan payment being a reserved Instant Payment transaction still waiting for a confirmation/rejection. Every X seconds (X being the “[Sweeping Timeout](#)” parameter configured in the system, see [1.7.1 “Service configuration”](#)) a process checks all the pending Instant Payments transactions and rejects only those that have exceeded the SCT^{Inst} Timestamp Timeout plus the Beneficiary side offset.

The time-out can also be triggered by an Investigation message from Originator Side that reaches TIPS requesting information for an existing Instant Payment transaction that is in status *Reserved* for which no Beneficiary-side answer is arrived yet and that has not been treated by Sweeping Service (see [2.4 “Investigation”](#)). In this case, TIPS does not answer to the Investigation directly, but set to *Expired* the Instant Payment transaction, informing both Originator and Beneficiary side accordingly for the occurred time-out.

Any Beneficiary-side answer that arrives in TIPS for an orphan payment already treated by the Sweeping service generates an error since no reserved transaction is found.

The diagram below describes the specific process and the involved actors. The details of the steps are described in the following [Table 57 – Instant Payment transaction missing/delayed Beneficiary-side answer steps](#).

Figure 20 – Instant Payment transaction missing/delayed Beneficiary-side answer flow

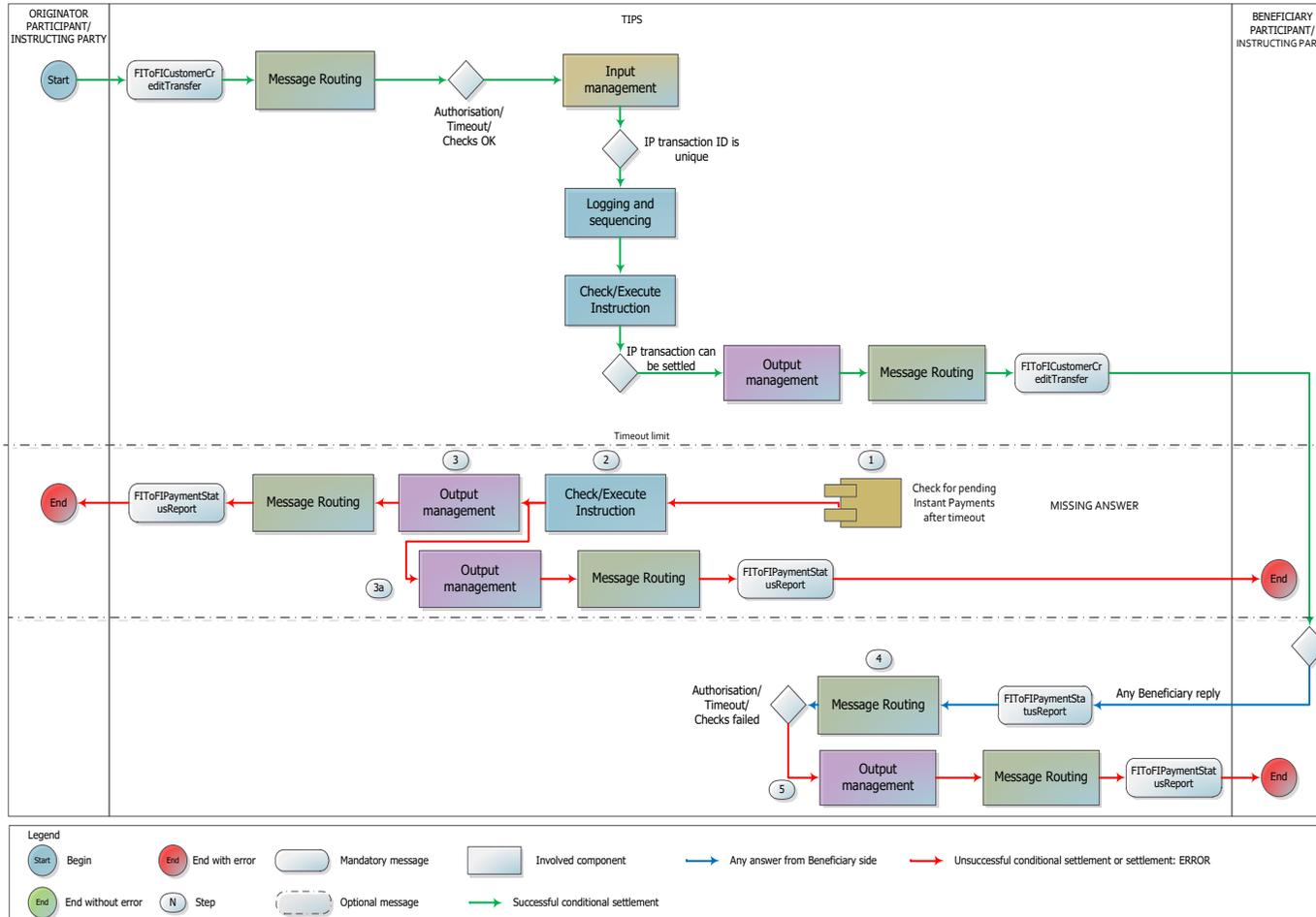

Table 57 – Instant Payment transaction missing/delayed Beneficiary-side answer steps

| Step | Involved messages | Involved actors | Description |
|------|--|--|---|
| 1 | | TIPS | Every X seconds, with "X" being defined in the " Sweeping timeout " parameter, the Sweeping service runs checking all the payment in status " <i>Reserved</i> ". If the "Acceptance timestamp" of the payment has exceeded the "SCT ^{Inst} Timestamp Timeout" value, the payment is elected for sweeping. |
| 1 | FIToFIPaymentStatusRequest | Originator Participant, Ancillary System or Instructing Party as Sender TIPS as receiver | TIPS receives an incoming Investigation request from the Originator Participant, Ancillary System or Instructing Party. There is no existing generated payment transaction status advice for the transaction and no answer from Beneficiary side has reached TIPS. |
| 2 | | TIPS | TIPS executes these operations for each orphan payment: - TIPS retrieves the transaction to be rejected and its ID executing the check " Timeout Check - Missing answer " (see 4.1- Business Rules for details); - The transaction is set to " <i>Expired</i> " status; - The reserved amount is released in the involved Originator account and the possibly involved Debiting CMB is increased by the same amount TIPS always releases the reserved transactions even if the involved account or CMB have been blocked in the meantime. |
| 3 | FIToFIPaymentStatusReport | TIPS as sender Originator Participant, Ancillary System or Instructing Party as receiver | TIPS sends a message to the Originator Participant, Ancillary System or Instructing Party – same DN of the Sender taken from the transaction under analysis. The FIToFIPaymentStatusReport contains the Transaction ID of the transaction and the proper error code. |
| 3a | FIToFIPaymentStatusReport | TIPS as sender Beneficiary Participant, Ancillary System or Instructing Party as receiver | TIPS sends a message to the Beneficiary Participant, Ancillary System or Instructing Party identified as the default DN in the entity "Outbound DN-BIC Routing" related to the Beneficiary BIC in the transaction under analysis. The FIToFIPaymentStatusReport contains the Transaction ID of the transaction and the proper error code. |
| 4 | | TIPS | TIPS unsuccessfully executes the check: - Pending transaction existing . See 4.1- Business Rules for details. |

| Step | Involved messages | Involved actors | Description |
|------|---|--|--|
| 5 | FIToFIPaymentStatusReport | TIPS as sender Beneficiary Participant, Ancillary System or Instructing Party as receiver | TIPS sends a FIToFIPaymentStatusReport message to the Beneficiary Participant, Ancillary System or Instructing Party (DN of the sender of the message) containing the proper error code. |

2.2.1.2. Examples

This sub-section includes a not exhaustive list of examples of TIPS transactions and related messages.

Each example is introduced by a description of the involved actors and involved messages and it highlights how the balances change in the accounts.

All the examples are based on the data constellation introduced below. The data constellation is depicted on the basis of the concepts introduced in [1.3.2 "Accounts structure and organisation"](#).

Figure 21 – Instant Payment transaction examples data constellation

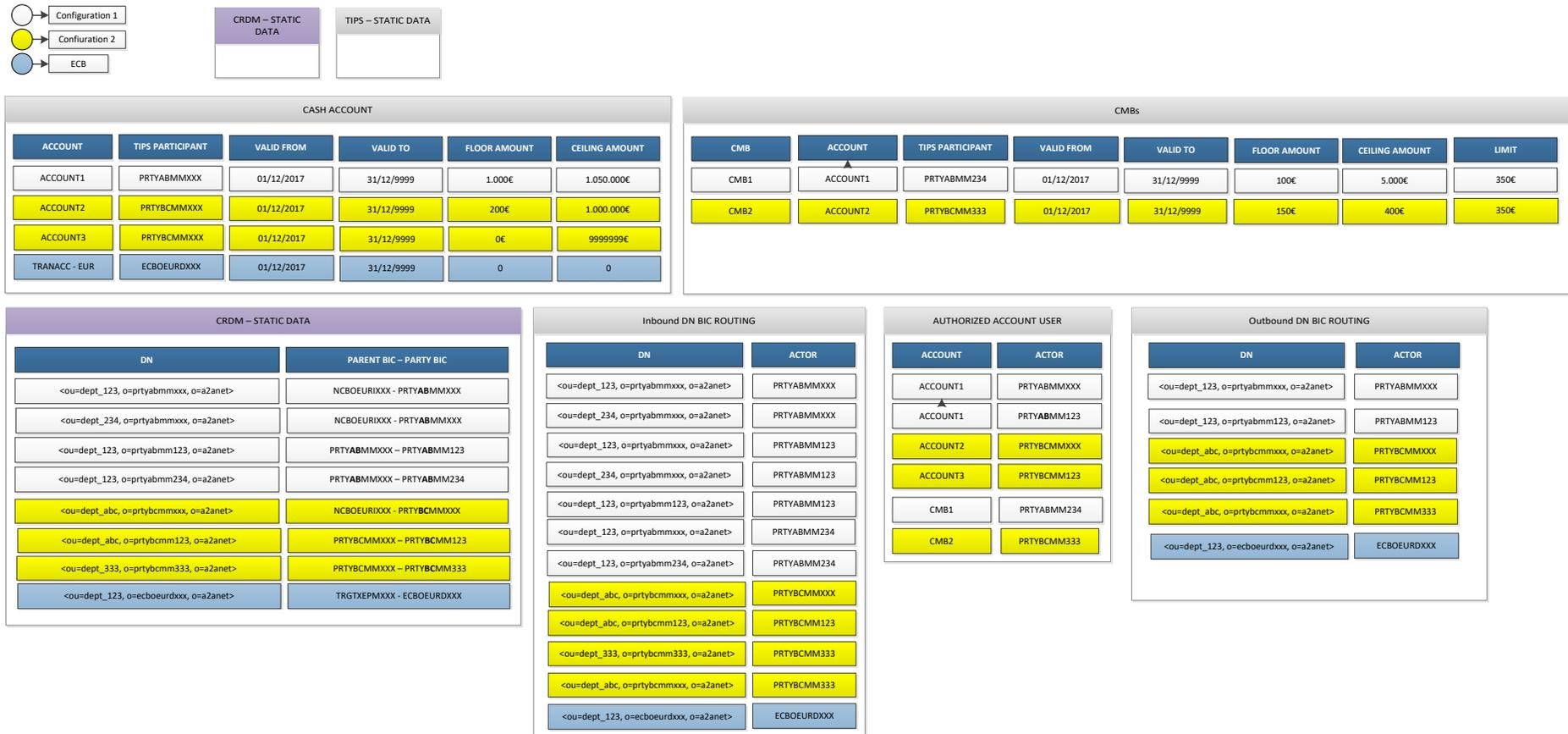

2.2.1.2.1 Successful scenario with confirmed order – only accounts involved

This positive scenario describes a successful payment transaction between two TIPS Accounts owned and held by two TIPS Participants sending the messages on their own (no Instructing Party different from the TIPS Participant(s) foreseen). “Configuration 1” and “Configuration 2” (highlighted in white and yellow in the [Figure 21 – Instant Payment transaction examples data](#) constellation) are considered.

No errors or timeouts occur. No floor or ceiling notification expected. The current business date, in the given example, is 30/12/2017. The [FltoFICustomerCreditTransfer](#) message received by TIPS and triggering the scenario looks like the following one.

Figure 22 – Successful Instant Payment transaction: FltoFICustomerCreditTransfer



The system, after performing the expected checks successfully, sets up the settlement on the accounts as follows:

- It identifies the Originator Account (ACCOUNT1) from the Originator BIC;
- It identifies the Beneficiary Account (ACCOUNT2) from the Beneficiary BIC;
- It identifies the Beneficiary DN from the “Outbound DN-BIC Routing”
(<ou=dept_abc, o=prtybcmxxx, o=a2anet>);
- It reserves the amount in ACCOUNT1 – the new availability for ACCOUNT1 decreases from 1,000.00 EUR to 900.00 EUR;
- The transaction is saved and put in status *Reserved*.

The forwarding of the [FltoFICustomerCreditTransfer](#) message to the Beneficiary DN ends the Conditional Settlement phase.

Figure 23 – Successful Instant Payment transaction: reservation of funds

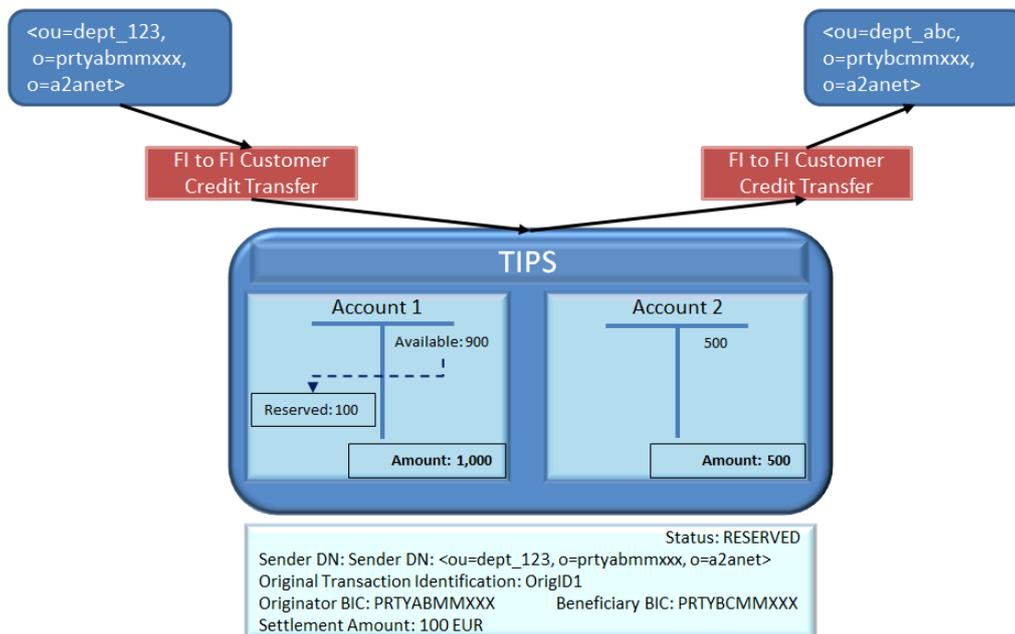

The answer from the Beneficiary triggers the settlement phase. In this scenario, the Beneficiary PSP confirms the payment by sending a [FIToFIPaymentStatusReport](#) message with a positive answer. TIPS definitively settles the transaction, moving the amount from ACCOUNT1 to ACCOUNT2.

Figure 24 – Successful Instant Payment transaction: FItoFIPaymentStatusReport



The system, after performing the expected checks successfully, finds the reserved transaction and executes the settlement on the accounts as follows:

- It identifies the transaction from the Original Transaction ID. The transaction must be in status *Reserved*.
- it identifies the Originator Account (ACCOUNT1) and the Beneficiary Account (ACCOUNT2) from the retrieved transaction;
- It identifies the Originator DN from the transaction;
- It definitively settles the amount moving the liquidity reserved in the ACCOUNT1 to the ACCOUNT2;
- The transaction status is turned into *Settled*.

TIPS then forwards the [FIToFIPaymentStatusReport](#) message to the Originator DN and sends a confirmation message for successful settlement to the Beneficiary.

Figure 25 – Successful Instant Payment transaction: settlement phase

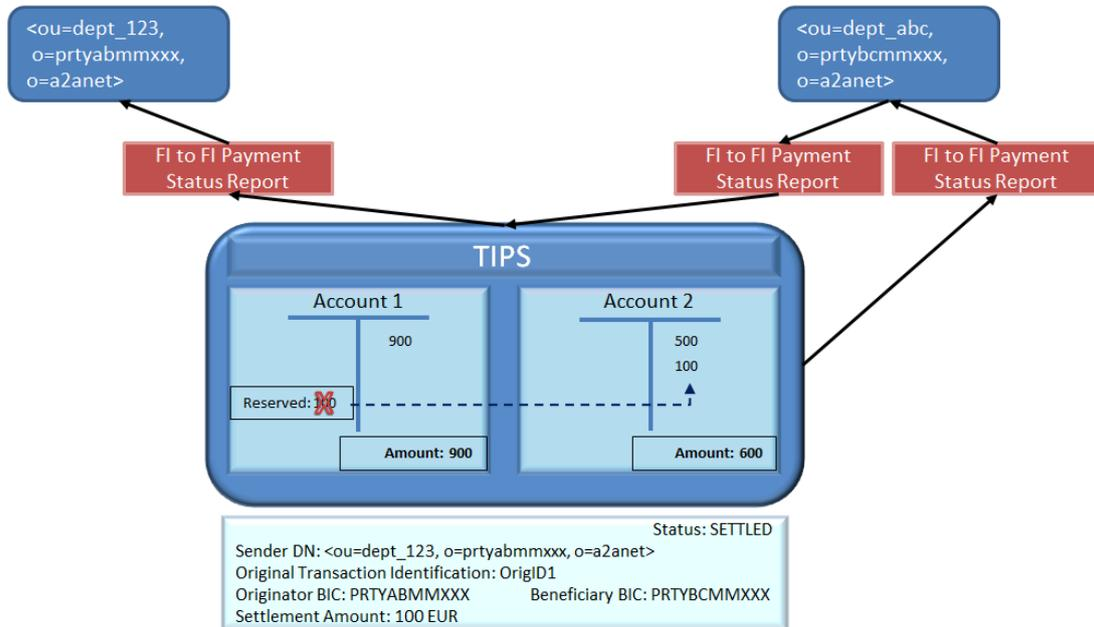

2.2.1.2.2 Successful scenario with confirmed order – Creditor account and debtor CMB

This positive scenario describes a successful payment transaction between a CMB held by a branch of a TIPS Participant A sending messages on its own and a TIPS Account owned by a TIPS Participant B but used by a related Reachable Party. “Configuration 1” and “Configuration 2” (highlighted in white and yellow in Figure 21 – Instant Payment transaction examples data constellation) are considered.

No errors or timeouts occur. No floor or ceiling notification is expected. The current business date, in the given example, is 30/12/2017. The [FltoFICustomerCreditTransfer](#) message received by TIPS and triggering the scenario looks like the following one.

Figure 26 – Successful Instant Payment transaction: FltoFICustomerCreditTransfer



The system, after performing the expected checks successfully, sets up the settlement on the accounts and on the CMB as follows:

- It identifies the Debiting CMB (CMB1) from the Originator BIC;
- It identifies the Originator Account from the CMB1 (ACCOUNT1);
- It identifies the Beneficiary Account (ACCOUNT3) from the Beneficiary BIC;
- It identifies the Beneficiary DN from the “Outbound DN-BIC Routing” (<ou=dept_abc, o=prtybcm123, o=a2anet>);
- It decreases the headroom for the involved CMB1;
- It reserves the amount for ACCOUNT1 related to the CMB – the new availability for ACCOUNT1 decreases from 800.00 EUR to 774.00 EUR;
- The transaction is saved and put in status *Reserved*.

The forwarding of the [FItoFICustomerCreditTransfer](#) message to the Beneficiary DN ends the Conditional Settlement phase.

Figure 27 – Successful Instant Payment transaction: reservation of funds

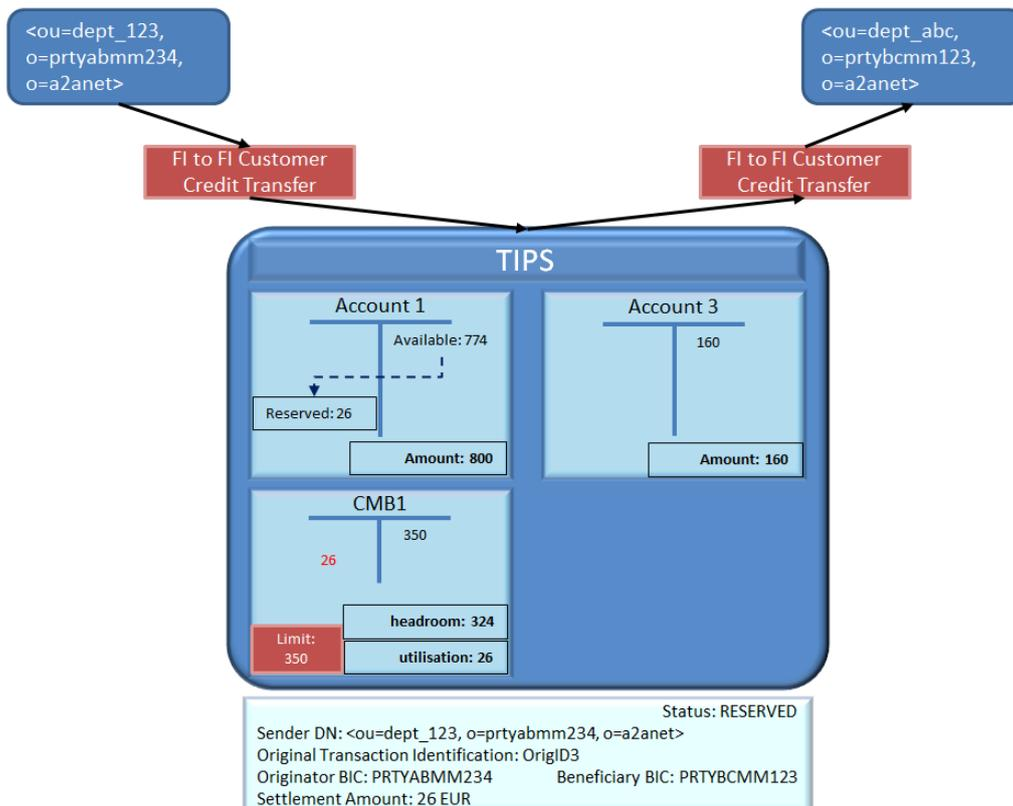

The answer from the Beneficiary Participant triggers the settlement phase. In this scenario, the Beneficiary Participant confirms the payment sending a [FIToFIPaymentStatusReport](#) message with a positive answer. TIPS definitively settles the transaction, moving the amount from ACCOUNT1 to ACCOUNT3. The movement on CMB1 is confirmed.

Figure 28 – Successful Instant Payment transaction: FItoFIPaymentStatusReport



The system, after performing the expected checks successfully, finds the reserved transaction and executes the settlement on the accounts as follows:

- It identifies the transaction from the Original Transaction ID. The transaction must be in status *Reserved*.
- It identifies the Originator Account (ACCOUNT1) and the Beneficiary Account (ACCOUNT3) from the retrieved transaction;
- It identifies the Originator DN from the transaction;
- It definitively settles the amount by moving the liquidity reserved in the ACCOUNT1 to the ACCOUNT3;
- The transaction status is turned into *Settled*.

In this example, CMB1 has no additional movements – the reduction of the headroom is confirmed. The settlement phase ends and TIPS then forwards the [FItoFIPaymentStatusReport](#) message to the Originator DN and sends a confirmation message for successful settlement to the Beneficiary Participant.

Figure 29 – Successful Instant Payment transaction: settlement phase

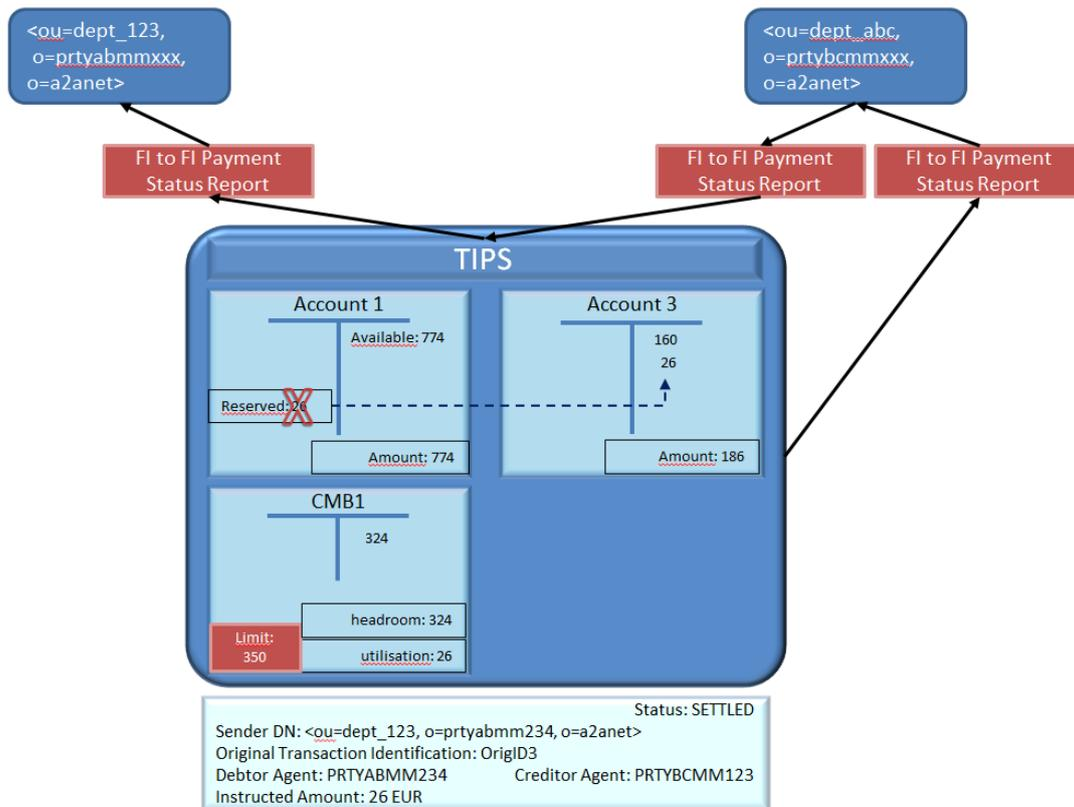

2.2.1.2.3 Successful scenario with confirmed order – Creditor CMB and debtor Account

This positive scenario describes a successful payment transaction between a TIPS Account owned and held by a TIPS Participant A sending the messages on its own and a CMB held by a branch of a TIPS Participant B. The TIPS Participant B acts as Instructing Party for its branch. “Configuration 1” and “Configuration 2” (highlighted in white and yellow in [Figure 21 – Instant Payment transaction examples data](#) constellation) are considered.

No errors or timeouts occur. No floor or ceiling notification is expected. The current business date, in the given example, is 30/12/2017. The [FltoFICustomerCreditTransfer](#) message received by TIPS and triggering the scenario looks like the following one.

Figure 30 – Successful Instant Payment transaction: FltoFICustomerCreditTransfer



TIPS, after performing the expected checks successfully, sets up the settlement on the accounts and on the CMB as follows:

- It identifies the Originator Account (ACCOUNT1) from the Originator BIC;
- It identifies the Crediting CMB (CMB2) from the Beneficiary BIC;
- It identifies the Beneficiary Account (ACCOUNT2) from the CMB2 in table CMBs;
- It identifies the Beneficiary DN from the “Outbound DN-BIC Routing”
(`<ou=dept_abc, o=prtybcmxxx, o=a2anet>`);
- It reserves the amount in ACCOUNT1 – the new availability for ACCOUNT1 decreases from 1,000.00 EUR to 901.00 EUR;
- The transaction is saved and put in status *Reserved*.

The forwarding of the [FItoFICustomerCreditTransfer](#) message to the Beneficiary DN ends the Conditional Settlement phase.

Figure 31 – Successful Instant Payment transaction reservation of funds

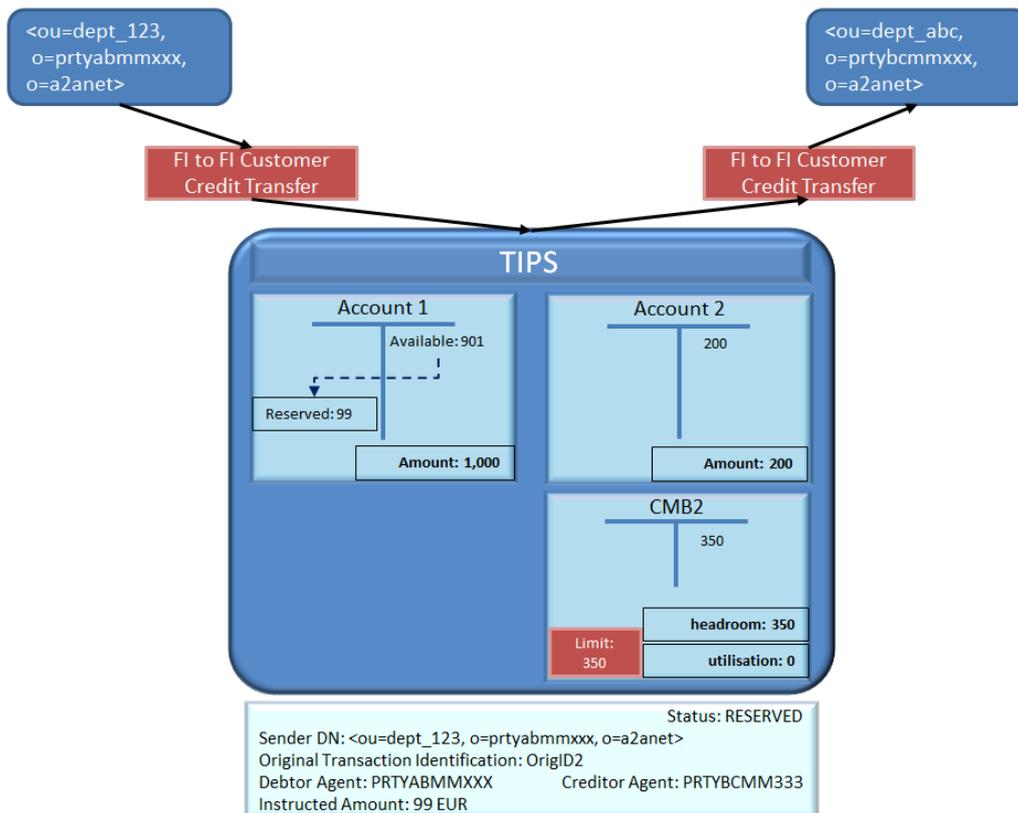

The answer from the Beneficiary Participant triggers the settlement phase. In this scenario, the Beneficiary PSP confirms the payment sending a [FIToFIPaymentStatusReport](#) message with a positive answer. TIPS definitively settles the transaction, moving the amount from ACCOUNT1 to ACCOUNT2 and increasing the headroom for CMB2.

Figure 32 – Successful Instant Payment transaction: FItoFIPaymentStatusReport



The system, after performing the expected checks successfully, finds the reserved transaction and executes the settlement on the accounts as follows:

- It identifies the transaction from the Original Transaction ID. The transaction must be in status *Reserved*.
- It identifies the Originator Account (ACCOUNT1), the Crediting CMB (CMB2) and the Beneficiary Account (ACCOUNT2) from the retrieved transaction;
- It identifies the Originator DN from the transaction;
- It definitively settles the amount moving the liquidity reserved in the ACCOUNT1 to the ACCOUNT2;
- It increases the headroom of the CMB2;
- The transaction status is turned into *Settled*.

In this example, CMB2 exceeds the defined limit for the CMB (the limit defined remains 350, the headroom is $350 + 99 = 449$ and the utilisation is -99 as depicted in [Figure 33 – Successful Instant Payment transaction: settlement](#)). The settlement phase ends and TIPS then forwards the [FIToFIPaymentStatusReport](#) message to the Originator DN and sends a confirmation message for successful settlement to the Beneficiary Participant.

Figure 33 – Successful Instant Payment transaction: settlement phase

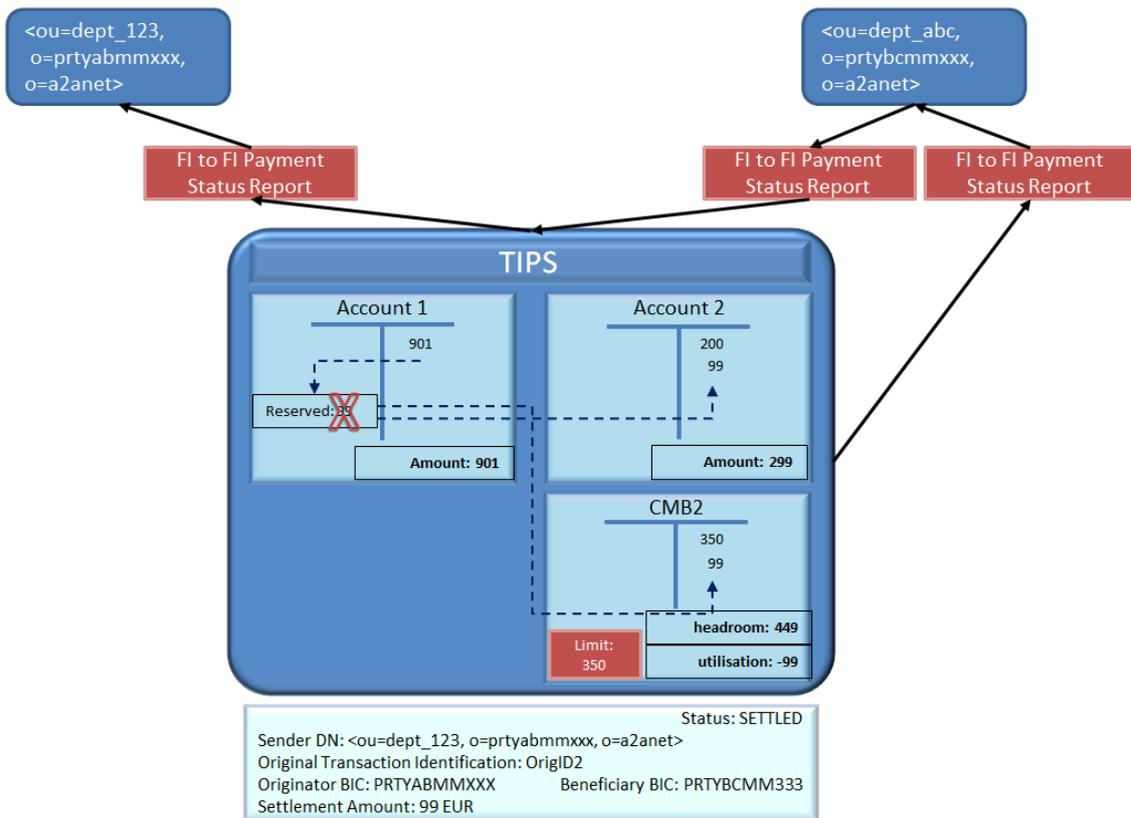

2.2.1.2.4 Successful scenario with rejected order

This negative scenario describes a successful reservation of funds for a transaction between a CMB held by a branch of a TIPS Participant A sending messages on its own and a TIPS Account owned by a TIPS Participant B. “Configuration 1” and “Configuration 2” (highlighted in white and yellow in [Figure 21 – Instant Payment transaction examples data constellation](#)) are considered.

After the successful reservation, the Beneficiary participant rejects the payment.

No errors or timeouts occur. No floor or ceiling notification is expected. The current business date, in the given example, is 30/12/2017. The [FltoFICustomerCreditTransfer](#) message received by TIPS and triggering the scenario looks like the following one.

Figure 34 – Rejected Instant Payment transaction: FltoFICustomerCreditTransfer



The system, after performing the expected checks successfully, sets up the settlement on the accounts and on the CMB as follows:

- It identifies the Debiting CMB (CMB1) from the Originator BIC;
- It identifies the Originator Account from the CMB1 (ACCOUNT1);
- It identifies the Beneficiary Account (ACCOUNT3) from the Beneficiary BIC;
- It identifies the Beneficiary DN from the “Outbound DN-BIC Routing” (<ou=dept_abc, o=prtybcm123, o=a2anet>);
- It decreases the headroom for the involved CMB1;
- It reserves the amount for the ACCOUNT1 related to the CMB;
- The transaction is saved and put in status *Reserved*.

The forwarding of the [FltoFICustomerCreditTransfer](#) message to the Beneficiary DN ends the Conditional Settlement phase.

Figure 35 – Rejected Instant Payment transaction: reservation of funds

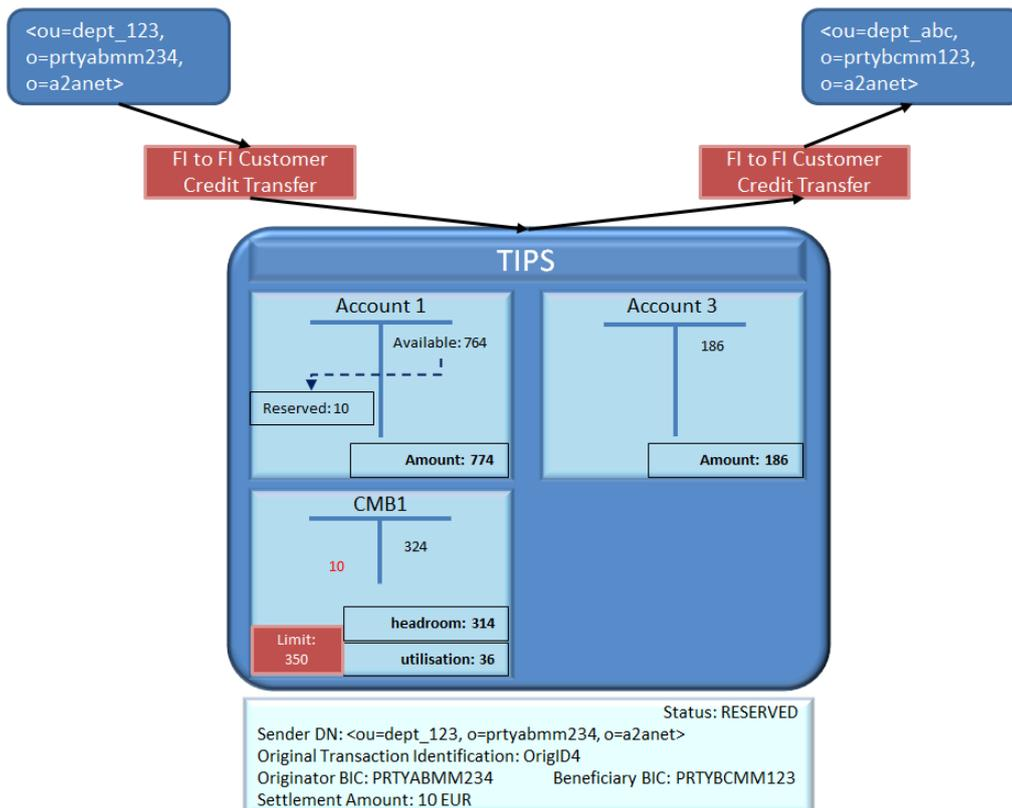

In this scenario, the Beneficiary Participant receives the forwarded [FltoFICustomerCreditTransfer](#) message with the transaction. The Beneficiary Participant rejects the payment sending a [FIToFIPaymentStatusReport](#) message with a negative answer.

The answer from the Beneficiary Participant triggers the settlement phase for a negative scenario³⁴. TIPS must then increase the CMB1 headroom of the same amount of the payment and release the amount on ACCOUNT1.

Figure 36 – Rejected Instant Payment transaction: FItoFIStatusReport



The system performs the expected checks successfully. The timeout check is not performed: a negative response from the Beneficiary side must always reach the Originator side with no changes and trigger the release of funds.

TIPS finds the reserved transaction, releases the funds on the accounts and increases the CMB headroom as follows:

- It identifies the transaction from the Original Transaction ID. The transaction must be in status *Reserved*.
- It identifies the Originator Account (ACCOUNT1) from the retrieved transaction;
- It releases the amount on the ACCOUNT1 and adds the same amount of the payment to CMB1;
- The transaction status is turned into *Rejected*;
- It identifies the Originator DN from the transaction.

The settlement phase ends with the rejection of the payment and TIPS then forwards the [FIToFIPaymentStatusReport](#) message to the Originator DN.

³⁴ The error code AC04 is used as an example in Figure 36, however the message can contain any error code sent by the beneficiary side.

Figure 37 – Rejected Instant Payment transaction: release of funds

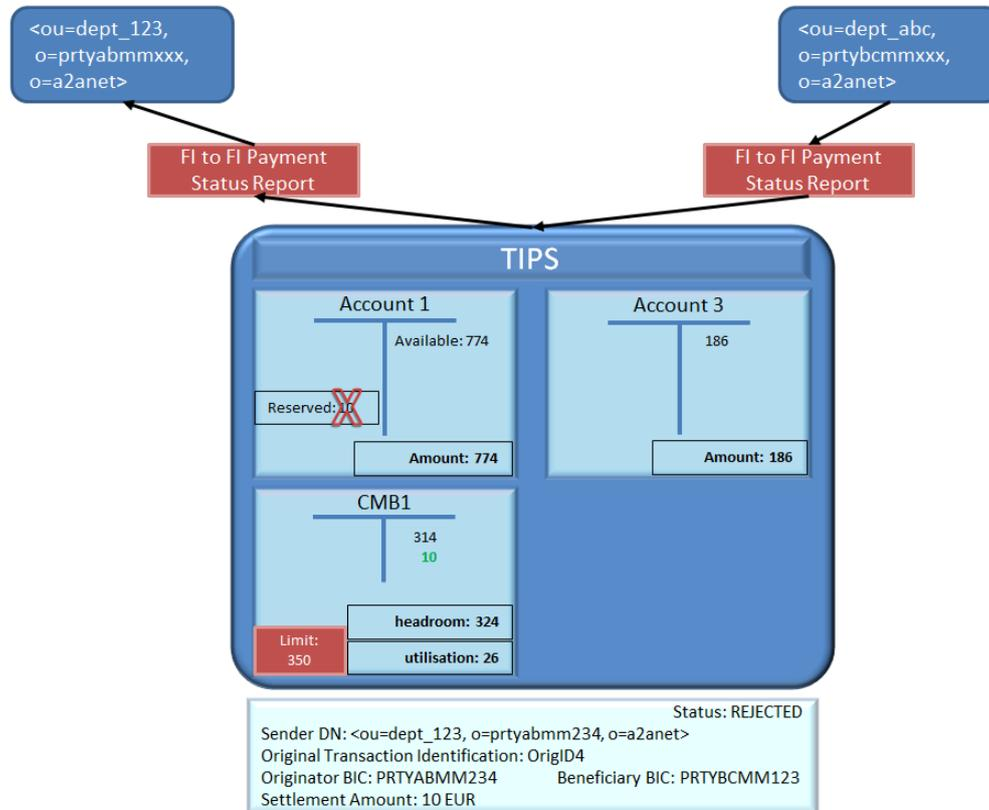

2.2.1.2.5 Successful scenario instant payment via TIPS AS Technical Account

This positive scenario describes a successful payment transaction between a TIPS AS Technical Account and a TIPS Account, the former owned by an Ancillary System and the latter owned by a TIPS Participant. Both actors send the messages on their own (without the involvement of an Instructing Party).

No errors or timeout condition is expected. The account owners did not configure any floor or ceiling notifications thresholds for their accounts. The current business date, in the given example, is 30/12/2021.

The following preconditions apply:

- PRTYADMMXXX is reachable via a selected Ancillary System (ANSYPRMMXXX) and it is authorised to settle on the corresponding TIPS AS Technical Account (TECHACCOUNTAS1);
- The initial balance on the TECHACCOUNTAS1 is 1,500,000.00 EUR.

The [FltoFICustomerCreditTransfer](#) message received by TIPS and triggering the scenario is the following one.

Figure 38 – Successful Instant Payment transaction: FItoFICustomerCreditTransfer



TIPS, after having performed successfully the checks on the incoming message, executes the following steps:

- It identifies the Originator Account (TECHACCOUNTAS1) from the Originator BIC;
- It identifies the Beneficiary Account (TIPSACCOUNT1) from the Beneficiary BIC;
- It identifies the Beneficiary DN from the “Outbound DN-BIC Routing” (<ou=dept_abc, o=prtybcmxxx, o=a2anet>);
- It reserves the amount in TECHACCOUNTAS1 – the balance available for new transactions on TECHACCOUNTAS1 decreases from 1,500,000.00 EUR to 1,499,000.00 EUR;
- The payment transaction is stored in TIPS with status *Reserved*.

The forwarding of the [FItoFICustomerCreditTransfer](#) message to the Beneficiary DN terminates the Conditional Settlement phase.

Figure 39 – Successful Instant Payment transaction: reservation of funds

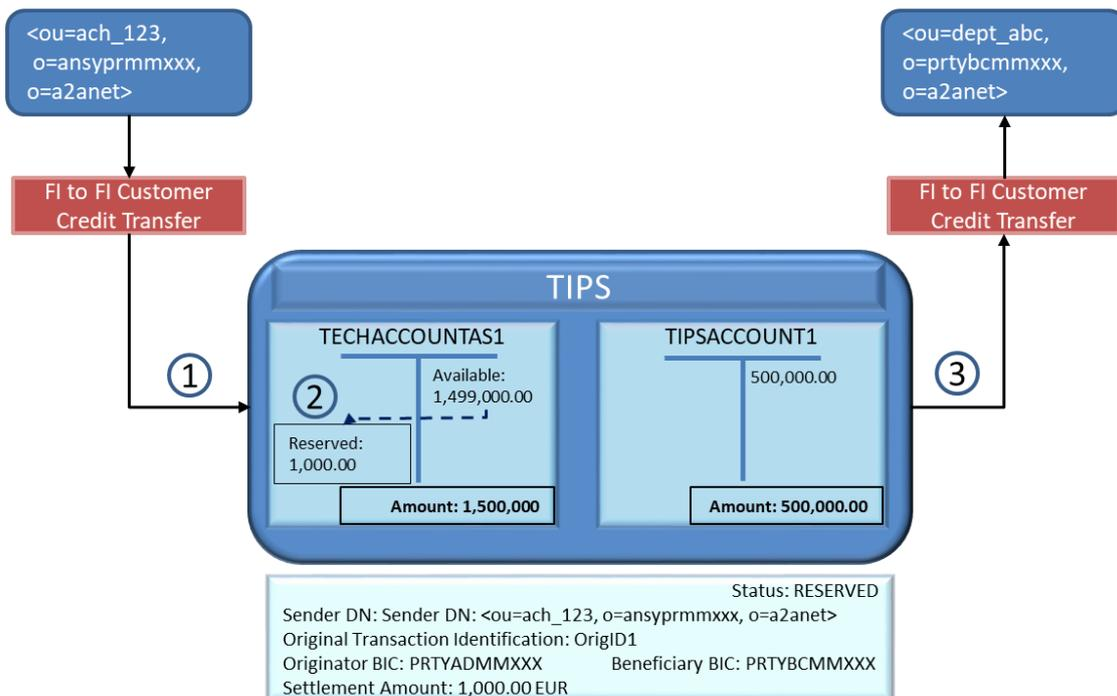

The answer from the Beneficiary Participant triggers the settlement phase. In this scenario, the Beneficiary Participant confirms the payment by sending a [FIToFIPaymentStatusReportt](#) message with a positive answer.

Figure 40 – Successful Instant Payment transaction: FItoFIPaymentStatusReport



TIPS, after performing the expected checks successfully, looks up the underlying open business case and settle on the accounts as follows:

- It identifies the transaction from the Original Transaction ID. The transaction shall be in status *Reserved*.
- it identifies the Originator Account (TECHACCOUNTAS1) and the Beneficiary Account (TIPSACCOUNT1) from the retrieved transaction;
- It identifies the Originator DN from the transaction (i.e. <ou=ach_123, o=ansyprmmxxx, o=a2anet>);
- It settles the amount moving the reserved liquidity from the TECHACCOUNTAS1 to the TIPSACCOUNT1;
- The transaction status is moved to *Settled*.

TIPS then forwards the [FIToFIPaymentStatusReportt](#) message received by the Beneficiary Participant to the Originator DN and generates a confirmation message for successful settlement to the Beneficiary Participant.

Figure 41 – Successful Instant Payment transaction successful: settlement phase

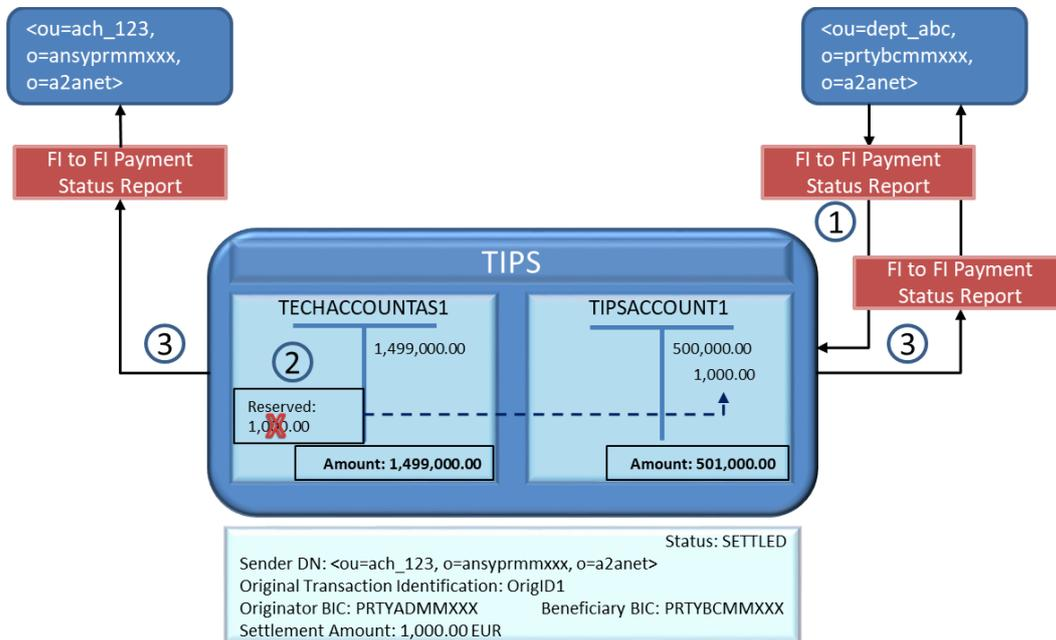

2.2.1.2.6 Error scenarios

This section describes some possible error scenarios that can happen when dealing with Instant Payment. This is a subset of possible error cases but the error mechanism is always the same.

For the complete list of possible error codes, see [4.2 “List of Error codes”](#).

Insufficient funds within the CMB

This error scenario describes a payment transaction between a CMB held by a branch of a TIPS Participant A sending messages on its own and a TIPS Account owned by a TIPS Participant. “Configuration 1” and “Configuration 2” (highlighted in white and yellow in [Figure 21 – Instant Payment transaction examples data](#) constellation) are considered.

The transaction fails since the requested amount exceeds the headroom of the involved CMB.

The [FltoFICustomerCreditTransfer](#) message received by TIPS and triggering the scenario looks like the following one:

Figure 42 – Headroom error: FItoFICustomerCreditTransfer

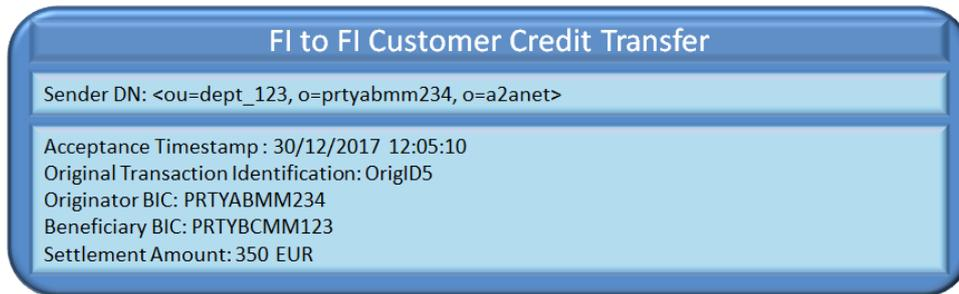

The system executes these steps:

- It identifies the Debiting CMB (CMB1) from the Originator BIC;
- It identifies that the headroom for the involved CMB1 is lower than the request amount;
- The transaction fails. The attempt is saved as failed transaction and the sender is informed of the error.

Figure 43 – Headroom error: transaction failed

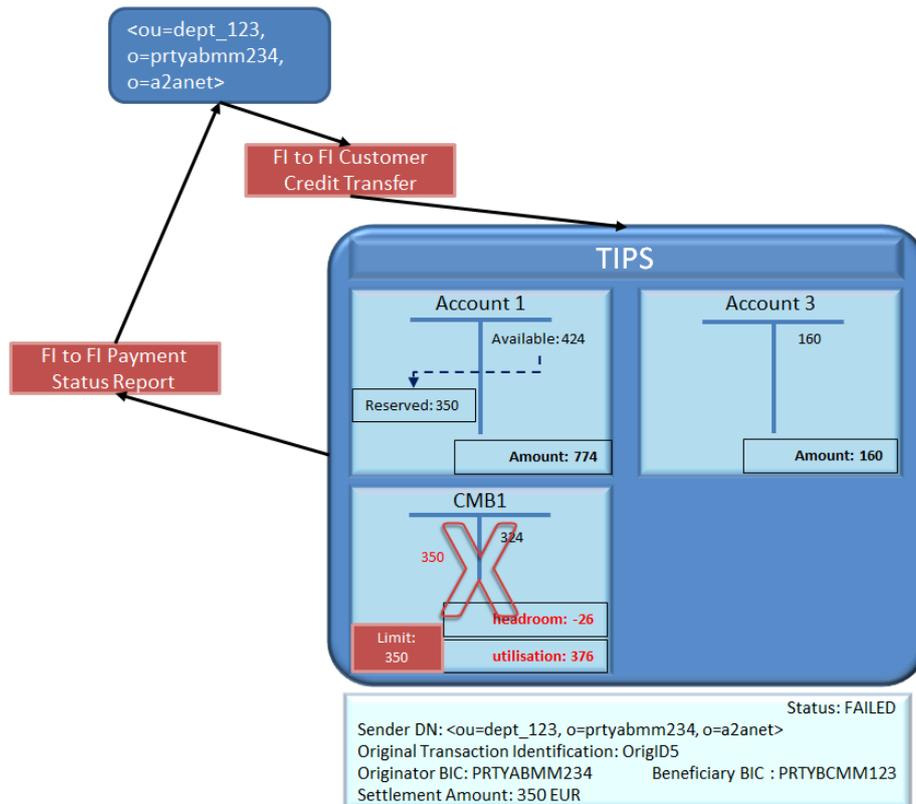

TIPS then sends a [FIToFIPaymentStatusReport](#) to the sender with the proper error code.

Figure 44 – Headroom error: FItoFIPaymentStatusReport



Blocked Account

This error scenario describes a payment transaction between two TIPS Accounts owned and held by two TIPS Participants sending the messages on their own (no Instructing Party different from the TIPS Participant(s) foreseen). “Configuration 1” and “Configuration 2” (highlighted in white and yellow in [Figure 21 – Instant Payment transaction examples data](#) constellation) are considered.

The transaction fails since the account to be debited is blocked and not available for settlement.

The [FItoFICustomerCreditTransfer](#) message received by TIPS and triggering the scenario looks like the following one.

Figure 45 – Blocked account error: FItoFICustomerCreditTransfer



The system executes these steps:

- It identifies the Debiting Account (ACCOUNT1) from the Originator BIC;
- It detects that ACCOUNT1 is blocked (e.g. status is either 'blocked for debit' or 'blocked for credit and debit');
- The transaction fails. The attempt is saved as failed Instant Payment transaction and the sender is informed of the error.

Figure 46 – Blocked account error: transaction failed

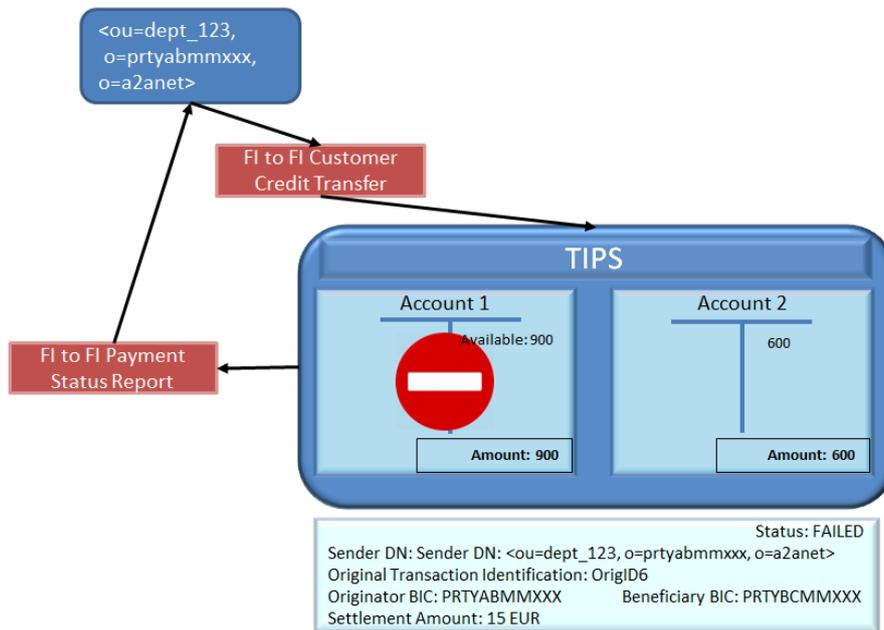

TIPS then sends a [FIToFIPaymentStatusReport](#) to the sender with the proper error code.

Figure 47 – Blocked account error: FItoFIPaymentStatusReport



Beneficiary side timeout

This error scenario describes a payment transaction between a CMB held by a branch of a TIPS Participant A sending messages on its own and a TIPS Account owned by a TIPS Participant. “Configuration 1” and “Configuration 2” (highlighted in white and yellow in [Figure 21 – Instant Payment transaction examples data](#) constellation) are considered.

The transaction fails since the answer from the Beneficiary Participant reaches TIPS after the foreseen timeout period.

The [FItoFICustomerCreditTransfer](#) message received by TIPS and triggering the scenario is shown in the following diagram.

Figure 48 – Beneficiary side timeout error: FItoFICustomerCreditTransfer



The system, after performing the expected checks successfully, sets up the settlement on the accounts and on the CMB as follows:

- It identifies the Debiting CMB (CMB1) from the Originator BIC;
- It identifies the Originator Account from the CMB1 (ACCOUNT1);
- It identifies the Beneficiary Account (ACCOUNT3) from the Beneficiary BIC;
- It identifies the Beneficiary DN from the “Outbound DN-BIC Routing (<ou=dept_abc, o=prtybcm123, o=a2anet>);
- It decreases the headroom for the involved CMB1;
- It reserves the amount for the ACCOUNT1 related to the CMB – the new availability for ACCOUNT1 decreases from 774.00 EUR to 744.00 EUR;
- The transaction is saved and put in status *Reserved*.

The forwarding of the [FItoFICustomerCreditTransfer](#) message to the Beneficiary DN ends the Conditional Settlement phase.

Figure 49 – Beneficiary side timeout error: reservation of funds

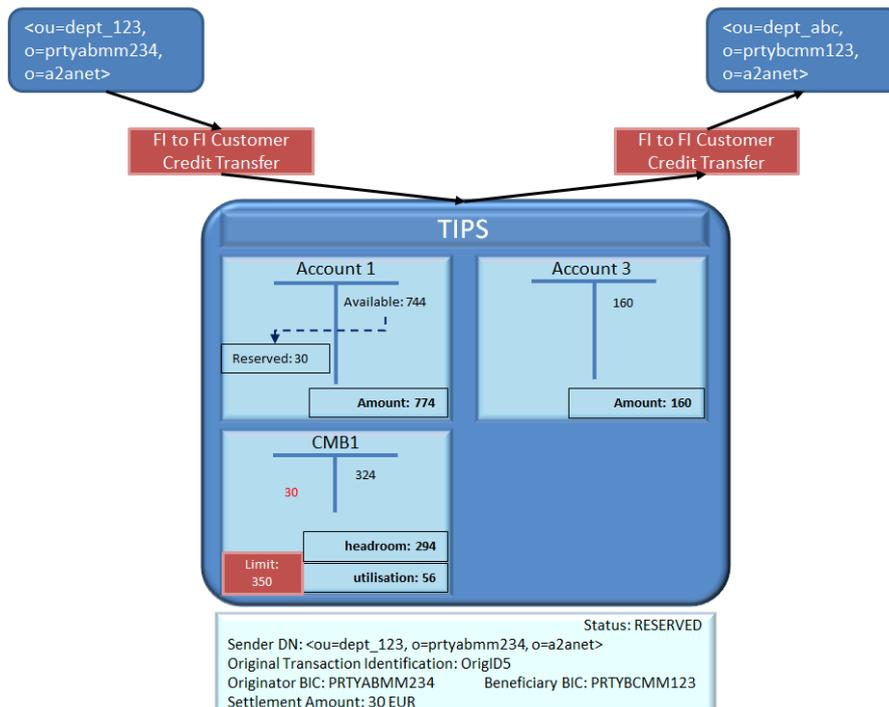

The answer from the Beneficiary Participant arrives when the timeout period is exceeded.

Figure 50 – Beneficiary side timeout error: FItoFIPaymentStatusReport



The timeout check on Beneficiary Participant side fails. TIPS finds the reserved transaction, releases the funds on the accounts and increases the CMB1 headroom as follows:

- It identifies the transaction from the Original Transaction ID. The transaction must be in status *Reserved*;
- It identifies the Originator Account (ACCOUNT1) from the retrieved transaction;
- It un-reserves the amount on the ACCOUNT1 and adds the same amount of the payment to CMB1;
- The transaction status is turned into *Expired*;
- It identifies the Originator DN from the transaction.

Figure 51 – Beneficiary side timeout error: release of funds

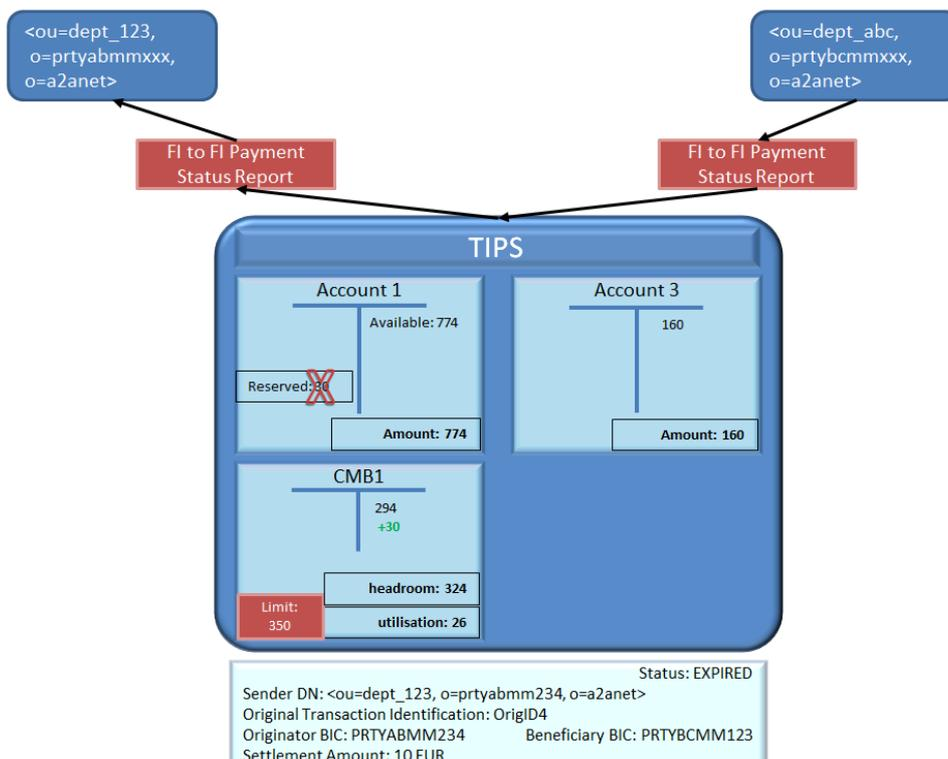

TIPS informs both sides of the transaction about the expiration. TIPS sends the message to:

- The DN of the sender of the Instant Payment transaction;
- The Beneficiary DN as configured in the “Outbound DN-BIC Routing (<ou=dept_abc, o=prtybcm123, o=a2anet>);
- The message for the Originator Participant (reason code equal to AB05) and the Beneficiary Participant (reason code equal to TM01) are respectively generated and sent as shown in the following diagram.

Figure 52 – Beneficiary side timeout error: FltoFIStatusReport

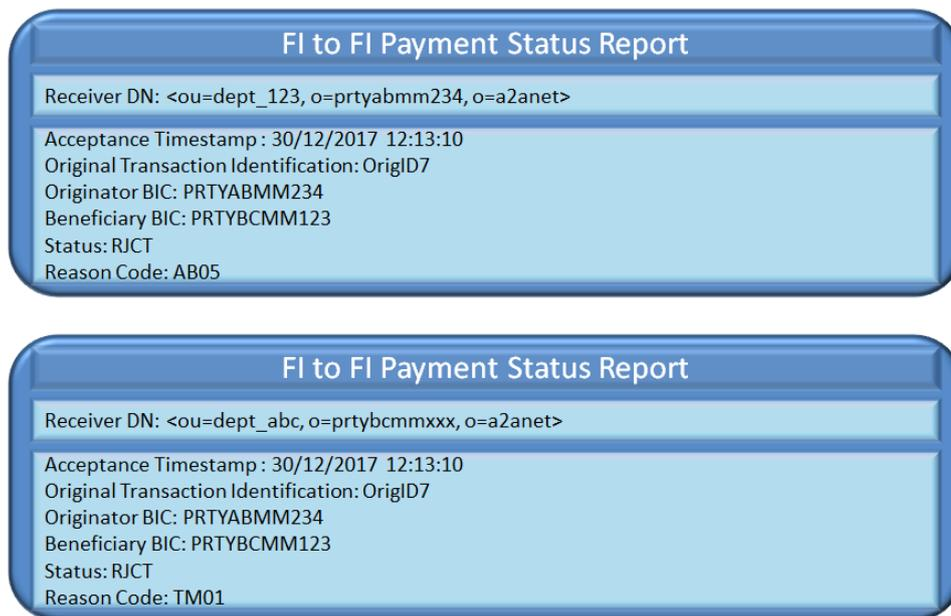

2.2.1.2.7 Delayed Beneficiary-side answer scenario

This error scenario describes a payment transaction between two TIPS Accounts owned and held by two TIPS Participants sending the messages on their own (no Instructing Party different from the TIPS Participant(s) foreseen). “Configuration 1” and “Configuration 2” (highlighted in white and yellow in [Figure 21 – Instant Payment transaction examples data constellation](#)) are considered.

In this scenario, the confirmation message from the Beneficiary Participant is delayed and, in the meantime, the Sweeper rejects the pending payment.

The [FltoFICustomerCreditTransfer](#) message received by TIPS and triggering the scenario looks like the following one.

Figure 53 – Delayed Beneficiary-side answer: FItoFICustomerCreditTransfer

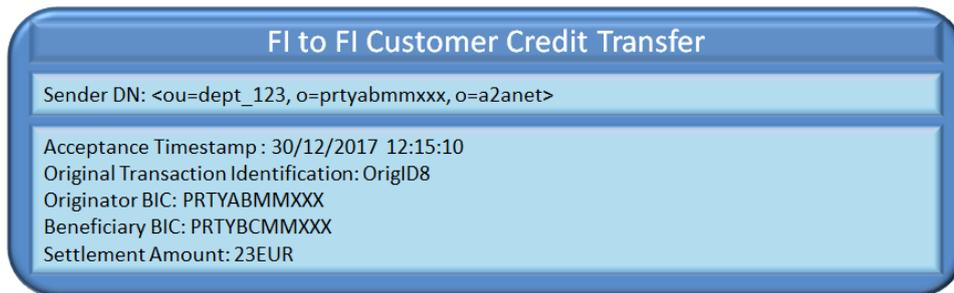

The system, after performing the expected checks successfully, sets up the settlement on the accounts as follows:

- It identifies the Originator Account (ACCOUNT1) from the Originator BIC;
- It identifies the Beneficiary Account (ACCOUNT2) from the Beneficiary BIC;
- It identifies the Beneficiary DN from the “Outbound DN-BIC Routing” (<ou=dept_abc, o=prtybcmxxx, o=a2anet>);
- It reserves the amount in ACCOUNT1;
- The transaction is saved and put in status *Reserved*.

The forwarding of the [FItoFICustomerCreditTransfer](#) message to the Beneficiary DN ends the Conditional Settlement phase.

Figure 54 – Delayed Beneficiary-side answer: reservation of funds

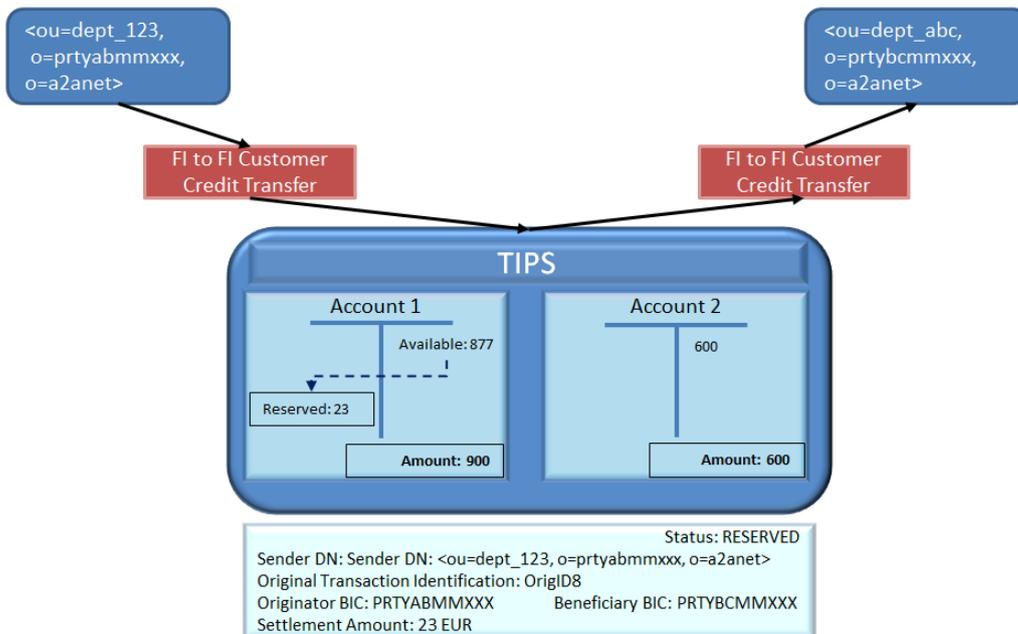

The answer from the Beneficiary side is delayed and does not reach TIPS in time to close the transaction. After a configured timeout, the Sweeper checks for pending payments. In case a pending

payment is found for which the [SCT^{Inst} Timestamp Timeout](#) has elapsed, TIPS triggers a timeout, rejects the transaction, releases the funds on the debtor account as follows:

- It identifies the Originator Account (ACCOUNT1) from the retrieved transaction;
- It releases the amount on the ACCOUNT1;
- The transaction status is turned into *Expired*;
- It identifies the Originator DN from the transaction;
- It identifies the Beneficiary DN from the transaction.

Figure 55 – Delayed Beneficiary-side answer: release of funds

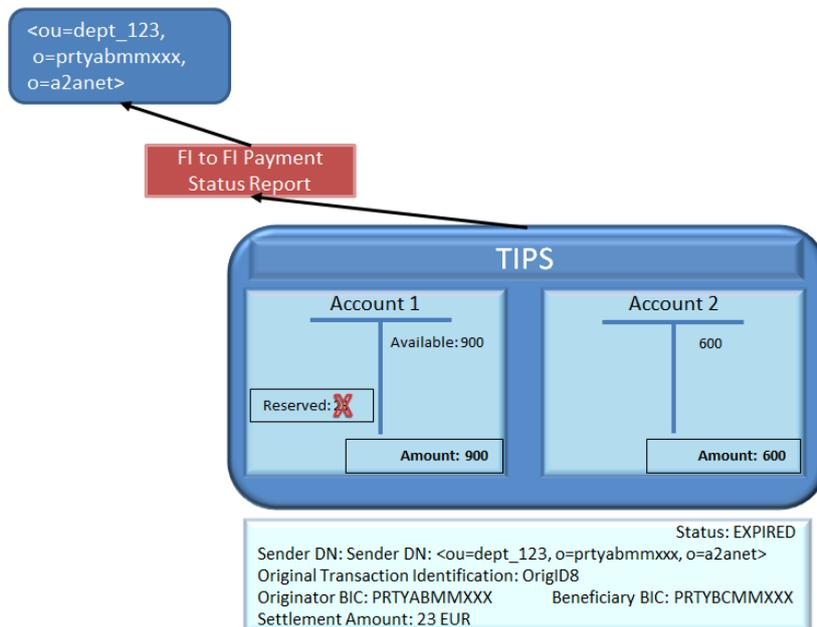

TIPS then sends a [FIToFIPaymentStatusReport](#) to both the Originator and the Beneficiary Participants with the proper error code (see respectively [Figure 56](#) for Originator side and [Figure 57](#) for Beneficiary side).

Figure 56 – Timeout answer: FItoFIPaymentStatusReport (Originator side)

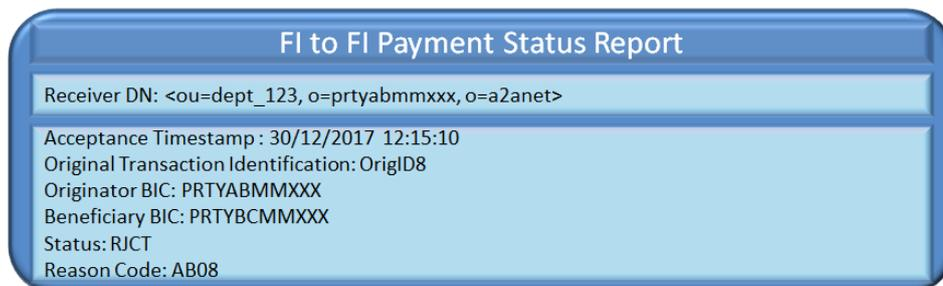
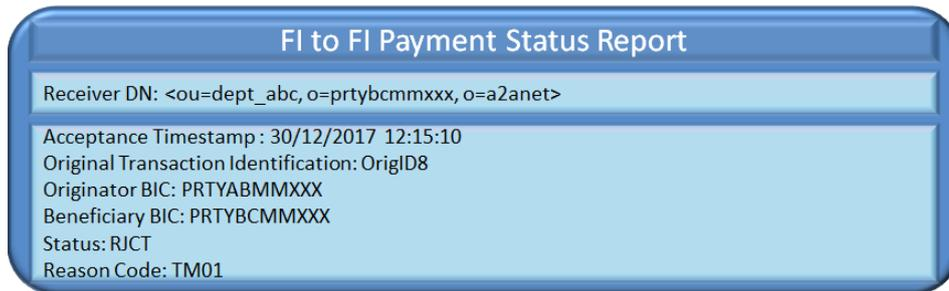

Figure 57 – Timeout answer: FltoFIPaymentStatusReport (Beneficiary side)



This example scenario foresees that Beneficiary-side reply reaches TIPS after the rejection due to timeout and un-reservation of funds of the relevant pending transaction. The delayed reply message generated by the Beneficiary Participant is the following.

Figure 58 – Delayed Beneficiary-side response: FltoFIPaymentStatusReport



TIPS rejects the message since the underlying transaction has been already rejected by the Sweeper and it is no longer in status pending.

Therefore, TIPS sends FI to FI Status Report to the same DN that sent the Beneficiary reply. The Original Transaction Identification inserted in the FI to FI Status Report is the one received in the Beneficiary reply.

Figure 59 – Delayed Beneficiary-side response: FltoFIPaymentStatusReport

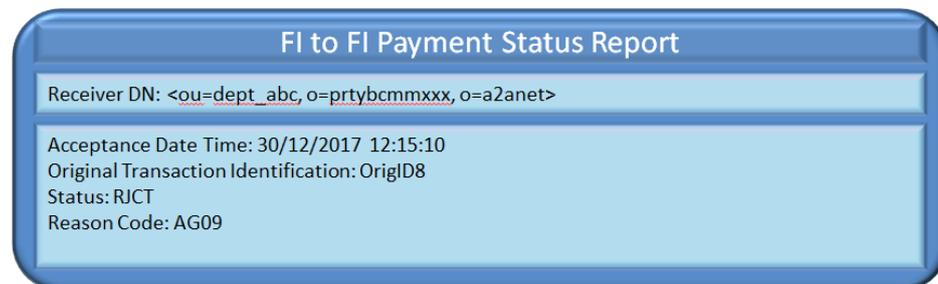

2.2.2. Instant Payment (non-Euro currencies scheme)

This section focuses on the settlement of Instant Payment transactions in non-Euro currencies, describing the full scenario and the related steps.

The introductory part of the section presents the general flow, including all the steps. A sub-section dedicated to the timeout follows, describing the specific case of timeout occurring when a Beneficiary reply is missing.

All the remaining sub-sections contain examples of the possible scenarios, starting from a successful one and detailing possible failure scenarios. Each example shows the relevant messages and how the main fields are filled.

The Instant Payment transaction process covers the scenarios in which an Originator Participant or Instructing Party acting on behalf of the Originator Participant or a Reachable Party instructs TIPS in order to transfer funds to the account of a Beneficiary Participant. The involved actors are:

- The Originator Participant, or Instructing Party acting on behalf of the Originator Participant or a Reachable Party, starting the scenario;
- The Beneficiary Participant, or Instructing Party acting on behalf of the Beneficiary Participant or a Reachable Party, receiving the request and either confirming or rejecting the payment.

The involved messages are:

- The [FIToFICustomerCreditTransfer](#) message sent by the Originator Participant or Instructing Party acting on behalf of the Participant/Reachable Party in order to (i) instruct the payment, (ii) to reserve the corresponding amount in a currency different from Euro and (iii) to inform the Beneficiary Participant or Instructing Party acting on behalf of the Participant/Reachable Party about the transaction received;
- The [FIToFIPaymentStatusReport \(pacs.002.001.10\)](#) message sent (i) by the Beneficiary Participant or Instructing Party acting on behalf of the Participant/Reachable Party to TIPS to either accept or reject the Instant Payment transaction, or (ii) by TIPS to inform the actors about the result of the settlement (i.e. settled, rejected, timed-out);
- The [ReturnAccount](#) message that can be possibly sent by TIPS to Creditor Account Owner and/or Debtor Account Owner. The message is sent by TIPS if (i) the owner of the TIPS Account (or CMB) enables the floor and ceiling notifications and (ii) the configured threshold is crossed.

All the described scenarios are triggered under the assumption that the technical validation, check of mandatory fields and authentication of the user have already been successfully performed by ESMIG.

As in the SCT^{Inst} processing, it is worth nothing that when the Debtor or Creditor BIC contains a BIC8 instead of a BIC11, the message is accepted and the BIC8 is translated into a BIC11 by appending "XXX" at the end of the BIC8 for further processing. All the steps are described considering BIC11 only.

Below is the diagram describing the process and the involved actors. The details of the steps are described in the following [Table 58 – Instant Payment transaction steps for non-Euro currencies](#).

Figure 60 – Instant Payment transaction flow for non-Euro currencies

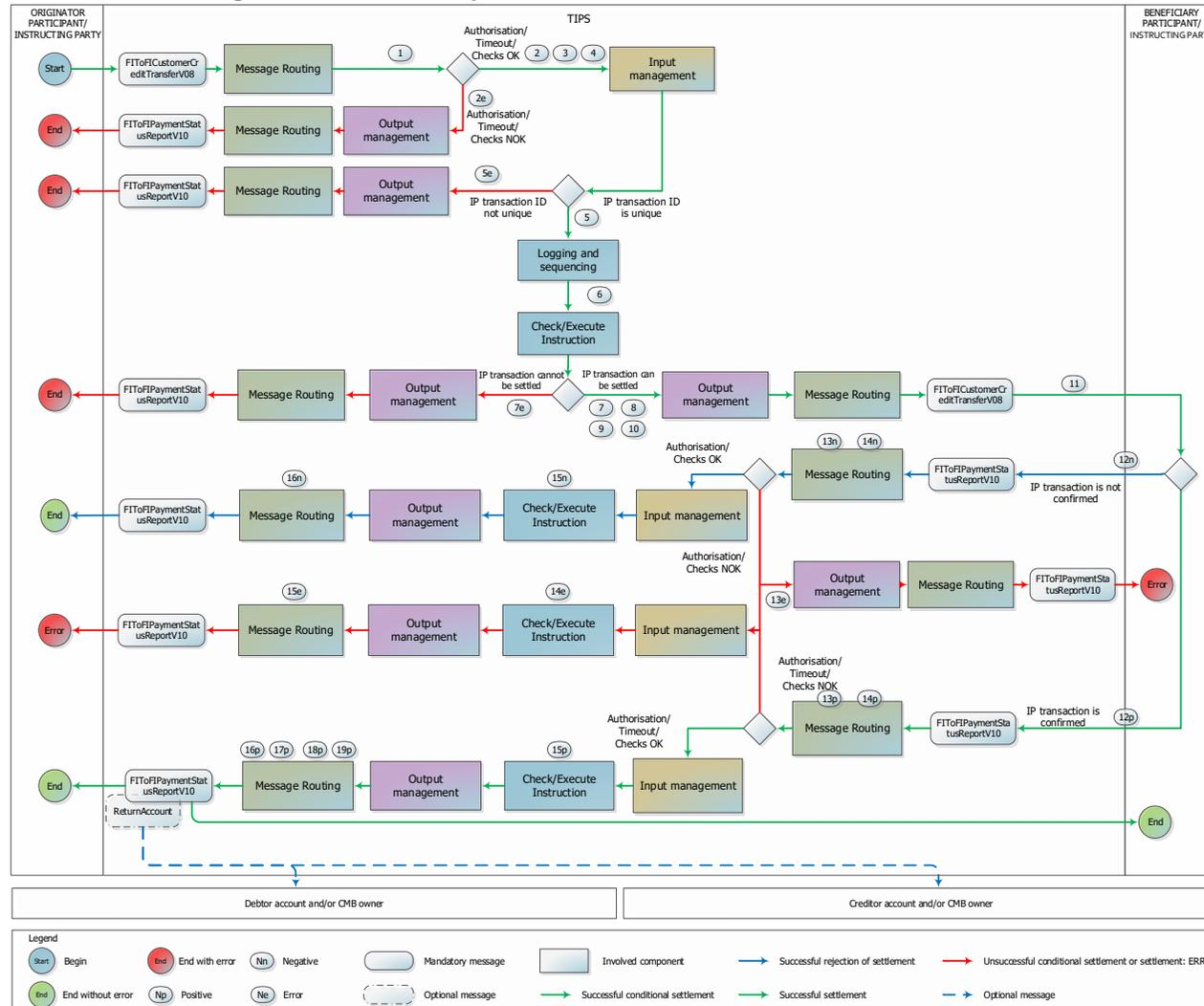

Table 58 – Instant Payment transaction steps for non-Euro currencies

| Step | Involved messages | Involved actors | Description |
|------|---|---|---|
| 1 | FIToFICustomerCreditTransfer | Originator Participant, Ancillary System or Instructing Party as Sender TIPS as receiver | TIPS receives an Instant Payment transaction in non-Euro currency from the Originator Participant, Ancillary System or Instructing Party acting on behalf of the Originator Participant or a Reachable Party starting the conditional settlement phase of the transaction. Technical validation, check of mandatory fields and authentication checks have already been successfully executed. The timeout for the Instant Payment transaction has not expired. TIPS logs the instruction as “ <i>Received</i> ”. |
| 2 | | TIPS | TIPS successfully executes the checks: <ul style="list-style-type: none"> - Access Rights check; - Timeout Check - Originator Side; - Maximum Amount not Exceeded; - Originator Account or CMB existence; - Instructing Party authorised; - Beneficiary correctly configured; - Beneficiary Account or CMB existence. <p>See 4.1- Business Rules for details.</p> |
| 2e | FIToFIPaymentStatusReport (pacs.002.001.10) | TIPS as sender Originator Participant, Ancillary System or Instructing Party as receiver | TIPS unsuccessfully executes one of the checks listed in step 2 . At the first negative check the system stops and sends a message to the Originator Participant, Ancillary System or Instructing Party acting on behalf of the Originator Participant or a Reachable Party – same DN of the Sender in step 1 – containing the proper error code. If the failed check is “ Timeout Check - Originator Side ”, the status of the transaction is set to “ <i>Expired</i> ”; in all the other cases, the status is set to “ <i>Failed</i> ”. |
| 3 | | TIPS | TIPS infers the account to be debited from the configured accounts information, the Originator Participant BIC and the currency of the Instant Payment transaction. In details TIPS checks that: <ul style="list-style-type: none"> (i) an account, with either type “TIPS Account” or “TIPS AS Technical Account”, exists, (ii) it is linked to the Originator Participant (field “Originator BIC”) as authorised user, (iii) and it is denominated in the same currency as the one defined in the Settlement Amount. |

| Step | Involved messages | Involved actors | Description |
|------|---|---|--|
| | | | <ul style="list-style-type: none"> - If the check does not return any account, TIPS looks for a CMB linked to the Originator Participant (field "Originator BIC") as authorised user; - TIPS selects the account linked to the CMB; the account related to the CMB must be denominated in the same currency as the one defined in the Settlement Amount. From now on, the selected account is referred to as "Originator Account" and the possible CMB as "Debiting CMB". |
| 4 | | TIPS | <p>TIPS infers the account to be credited from the configured accounts information, the Beneficiary Participant BIC and the currency of the Instant Payment transaction.</p> <p>In details TIPS checks that:</p> <ul style="list-style-type: none"> (i) an account, with either type "TIPS Account" or "TIPS AS Technical Account", exists, (ii) it is linked to the Beneficiary Participant (field "Beneficiary BIC") as authorised user, (iii) and has a currency equal to the one defined in the Settlement Amount. <ul style="list-style-type: none"> - If the check does not return any account, TIPS looks for a CMB linked to the Beneficiary Participant (field "Beneficiary BIC") as authorised user; - TIPS selects the account linked to the CMB; the account related to the CMB must be denominated in the same currency as the one defined in the Settlement Amount. From now on, the selected account is referred to as "Beneficiary Account" and the possible CMB as "Crediting CMB". |
| 5 | | TIPS | <p>TIPS successfully executes the check:</p> <ul style="list-style-type: none"> - Duplicate check; <p>See 4.1 - Business Rules for details.</p> |
| 5e | FIToFIPaymentStatusReport (pacs.002.001.10) | TIPS as sender Originator Participant, Ancillary System or Instructing Party as receiver | <p>TIPS unsuccessfully executes the check listed in step 5.</p> <p>If the check is unsuccessful the validation stops and TIPS sends a message to the Originator Participant, Ancillary System or Instructing Party acting on behalf of the Originator Participant or a Reachable Party – same DN of the Sender – containing the proper error code.</p> <p>The transaction is set to "Failed" status.</p> <p>See 4.1 - Business Rules for details.</p> |
| 6 | | TIPS | <p>TIPS sends it to the Check and Execute Instruction process. TIPS sets the transaction status to "Validated".</p> |

| Step | Involved messages | Involved actors | Description |
|------|---|--|--|
| 7 | | TIPS | TIPS successfully executes the checks: <ul style="list-style-type: none"> - Originator Account/CMB not blocked; - Beneficiary Account/CMB not blocked; - Available amount not exceeded; See 4.1 - Business Rules for details. |
| 7e | FIToFIPaymentStatusReport (pacs.002.001.10) | TIPS as sender Originator Participant, Ancillary System or Instructing Party as receiver | TIPS unsuccessfully executes the checks listed in step 7 . At the first negative check the validation stops and TIPS sends a message to the Originator Participant, Ancillary System or Instructing Party acting on behalf of the Originator Participant or a Reachable Party – same DN of the Sender in step 1 – containing the proper error code. The transaction is set to "Failed" status. See 4.1 - Business Rules for details. |
| 8 | | TIPS | The DN of the Sender in step 1 is saved as information related to the transaction. From now on, this DN is referred to as "Originator DN". |
| 9 | | TIPS | TIPS reserves funds in the Originator account. The full amount is reserved as Reserved Balance in the Cash Balance. TIPS sets the transaction status to "Reserved". If a Debiting CMB is involved, the system decreases its headroom by the same amount. After this moment, the settlement attempt is agreed and can either be confirmed or rejected by the counterpart or fail for a missing answer. The reserved amount cannot be taken into account for other payments or liquidity transfers. |
| 10 | | TIPS | The DN of the beneficiary is identified in the "Outbound DN-BIC Routing" mapping table from the field Creditor Agent. From now on, this DN is referred to as "Beneficiary DN". |
| 11 | FIToFICustomerCreditTransfer | TIPS as sender Beneficiary Participant, Ancillary System or Instructing Party as receiver | TIPS forwards the received Instant Payment transaction to the Beneficiary DN. |
| 12p | FIToFIPaymentStatusReport (pacs.002.001.10) | Beneficiary Participant, Ancillary System or Instructing Party as sender TIPS as receiver | The Beneficiary Participant, Ancillary System or Instructing Party acting on behalf of the Beneficiary Participant or a Reachable Party starts the settlement phase of the transaction by sending a positive payment status report that is successfully delivered to TIPS. Technical validation, check of mandatory fields and authentication checks have already been successfully executed. |

| Step | Involved messages | Involved actors | Description |
|------|---|--|--|
| 13p | | TIPS | <p>TIPS successfully executes the checks:</p> <ul style="list-style-type: none"> - Access Rights check; - Instructing Party authorised – creditor side; - Pending transaction existing; - Timeout Check - Beneficiary Side. <p>See 4.1- Business Rules for details.</p> |
| 13e | FIToFIPaymentStatusReport (pacs.002.001.10) | TIPS as sender Beneficiary Participant, Ancillary System or Instructing Party as receiver | <p>TIPS unsuccessfully executes the checks listed in step 13p. At the first negative check the system stops and sends a message to the Beneficiary Participant, Ancillary System or Instructing Party acting on behalf of the Beneficiary Participant or a Reachable Party (DN of the sender of the message) containing the proper error code.</p> <p>See 4.1- Business Rules for details.</p> |
| 14e | | TIPS | <p>If the pending transaction exists, TIPS retrieves it using the Transaction ID. The reserved amount is released in the involved Originator account and the possibly involved Debiting CMB is increased of the same amount. TIPS always releases the reserved transactions even if the involved account or CMB have been blocked in the meantime.</p> <p>The transaction is set to "<i>Failed</i>" status.</p> |
| 15e | FIToFIPaymentStatusReport (pacs.002.001.10) | TIPS as sender Originator Participant, Ancillary System or Instructing Party as receiver | <p>TIPS sends a message to the Originator Participant, Ancillary System or Instructing Party acting on behalf of the Originator Participant or a Reachable Party – same DN of the Sender in step 1 – containing the proper error code.</p> |
| 14p | | TIPS | <p>TIPS identifies the transaction using the Transaction ID. The transaction Id is related to a transaction that exists in TIPS and still in "<i>Reserved</i>" status.</p> |
| 15p | | TIPS | <p>TIPS retrieves the reserved transaction and confirms it. The amount is considered settled and the transaction is set to "<i>Settled</i>" status. The reserved amount of the Originator account is decreased by the amount of the corresponding settled transaction. The same positive amount is added to the Beneficiary Account. If a Crediting CMB is involved, TIPS increases its headroom by the same amount.</p> |

| Step | Involved messages | Involved actors | Description |
|------|---|--|---|
| | | | TIPS always executes the reserved transactions even though the involved accounts (or CMBs) have been blocked in the meantime. |
| 16p | FIToFIPaymentStatusReport (pacs.002.001.10) | TIPS as sender Originator Participant, Ancillary System or Instructing Party as receiver | TIPS forwards the received FIToFIPaymentStatusReport (pacs.002.001.10) to the Originator DN. |
| 17p | FIToFIPaymentStatusReport (pacs.002.001.10) | TIPS as sender Beneficiary Participant, Ancillary System or Instructing Party as receiver | TIPS generates a positive Payment status report and sends it to the Beneficiary DN. The FIToFIPaymentStatusReport (pacs.002.001.10) contains the Transaction ID and Originator BIC of the transaction. |
| 18p | ReturnAccount | TIPS as sender Debited Account and/or CMB Owner | TIPS checks the "Floor notification amount" configured for the involved Originator account or Debiting CMB. After settlement confirmation, if the account balance and/or the CMB headroom crosses the threshold configured as "floor notification amount", TIPS sends a ReturnAccount to the Account and/or CMB owners involved in the transaction. The message is sent to the default DN of the Account Owner and/or CMB Owner. The message contains the Originator account number or the Debiting CMB number |
| 19p | ReturnAccount | TIPS as sender Credited Account and/or CMB Owner | TIPS checks the "Ceiling notification amount" configured for the involved Beneficiary account or Crediting CMB. After settlement confirmation, if the account balance and/or the CMB headroom crosses the threshold configured as "ceiling notification amount", TIPS sends a ReturnAccount to the Account and/or CMB owners involved in the transaction. The message is sent to the default DN of the Account Owner and/or CMB Owner. The message contains the Beneficiary account number or the Crediting CMB number |

| Step | Involved messages | Involved actors | Description |
|------|---|--|---|
| 12n | FIToFIPaymentStatusReport (pacs.002.001.10) | Beneficiary Participant, Ancillary System or Instructing Party as sender TIPS as receiver | The Beneficiary Participant, Ancillary System or Instructing Party acting on behalf of the Beneficiary Participant or a Reachable Party triggers the settlement phase of the transaction sending a negative payment status report that is successfully delivered to TIPS. In this scenario the settlement phase will end up with a rejection of the Instant Payment transaction and the un-reservation of corresponding funds. Technical validation, check of mandatory fields and authentication checks have already been successfully executed. |
| 13n | | TIPS | TIPS successfully executes the checks: - Access Rights check ; - Instructing Party authorised – creditor side ; - Pending transaction existing . See 4.1- Business Rules for details. |
| 13e | | TIPS as sender Beneficiary Participant, Ancillary System or Instructing Party as receiver | TIPS unsuccessfully executes the checks at step 13n . At the first negative check the system stops and sends a message to the Beneficiary Participant, Ancillary System or Instructing Party acting on behalf of the Beneficiary Participant or a Reachable Party (DN of the sender of the message) containing the proper error code. See 4.1- Business Rules for details. |
| 14e | | TIPS | If the pending transaction exists, TIPS retrieves it using the Transaction ID. The reserved amount is released in the involved Originator account and the possibly involved Debiting CMB is increased of the same amount. TIPS always releases the reserved transactions even if the involved account or CMB have been blocked in the meantime. The transaction is set to " <i>Failed</i> " status. |
| 15e | FIToFIPaymentStatusReport (pacs.002.001.10) | TIPS as sender Originator Participant, Ancillary System or Instructing Party as receiver | TIPS sends a message to the Originator Participant, Ancillary System or Instructing Party acting on behalf of the Originator Participant or a Reachable Party – same DN of the Sender in step 1 – containing the proper error code. |
| 14n | | TIPS | TIPS identifies the transaction using the Transaction ID. The Transaction ID is related to a transaction existing in TIPS and still in " <i>Reserved</i> " status. |

| Step | Involved messages | Involved actors | Description |
|------|---|---|---|
| 15n | | TIPS | TIPS retrieves the Instant Payment transaction to be rejected and releases it. The reserved amount is released in the involved Originator Account and the possibly involved Debiting CMB is increased of the same amount. TIPS always releases the reserved transactions even if the involved account or CMB have been blocked in the meantime. The transaction is set to " <i>Rejected</i> " status. |
| 16n | FIToFIPaymentStatusReport (pacs.002.001.10) | TIPS as sender Originator Participant, Ancillary System or Instructing Party as receiver | TIPS forwards the received Payment status report to the Originator DN. |

2.2.2.1. Timeout scenario: missing/delayed Beneficiary-side answer (non-Euro currencies scheme)

This sub-section describes the specific scenario of TIPS not receiving a Beneficiary-side answer or receiving it later than allowed.

This scenario assumes that TIPS has successfully executed the conditional settlement phase of an Instant Payment.

A specific software component (Sweeping service) is always acting in background taking care of all the orphan payments – an orphan payment being a reserved Instant Payment transaction still waiting for a confirmation/rejection. Every X seconds (X being the “[Sweeping Timeout](#)” parameter configured in the system, see [1.7.1 “Service configuration”](#)) a process checks all the pending Instant Payments transactions and rejects only those that have exceeded the Timestamp Timeout plus the Beneficiary side offset.

The time-out can also be triggered by an Investigation message from Originator Side that reaches TIPS requesting information for an existing Instant Payment transaction that is in status *Reserved* for which no Beneficiary-side answer is arrived yet and that has not been treated by Sweeping Service (see [2.4 “Investigation”](#)). In this case, TIPS does not answer to the Investigation directly, but set to *Expired* the Instant Payment transaction, informing both Originator and Beneficiary side accordingly for the occurred time-out.

Any Beneficiary-side answer that arrives in TIPS for an orphan payment already treated by the Sweeping service generates an error since no reserved transaction is found.

The diagram below describes the specific process and the involved actors. The details of the steps are described in the following [Table 59 – Instant Payment transaction missing/delayed Beneficiary-side answer steps \(non-Euro currencies\)](#).

Figure 61 – Instant Payment transaction missing/delayed Beneficiary-side answer flow (non-Euro currencies)

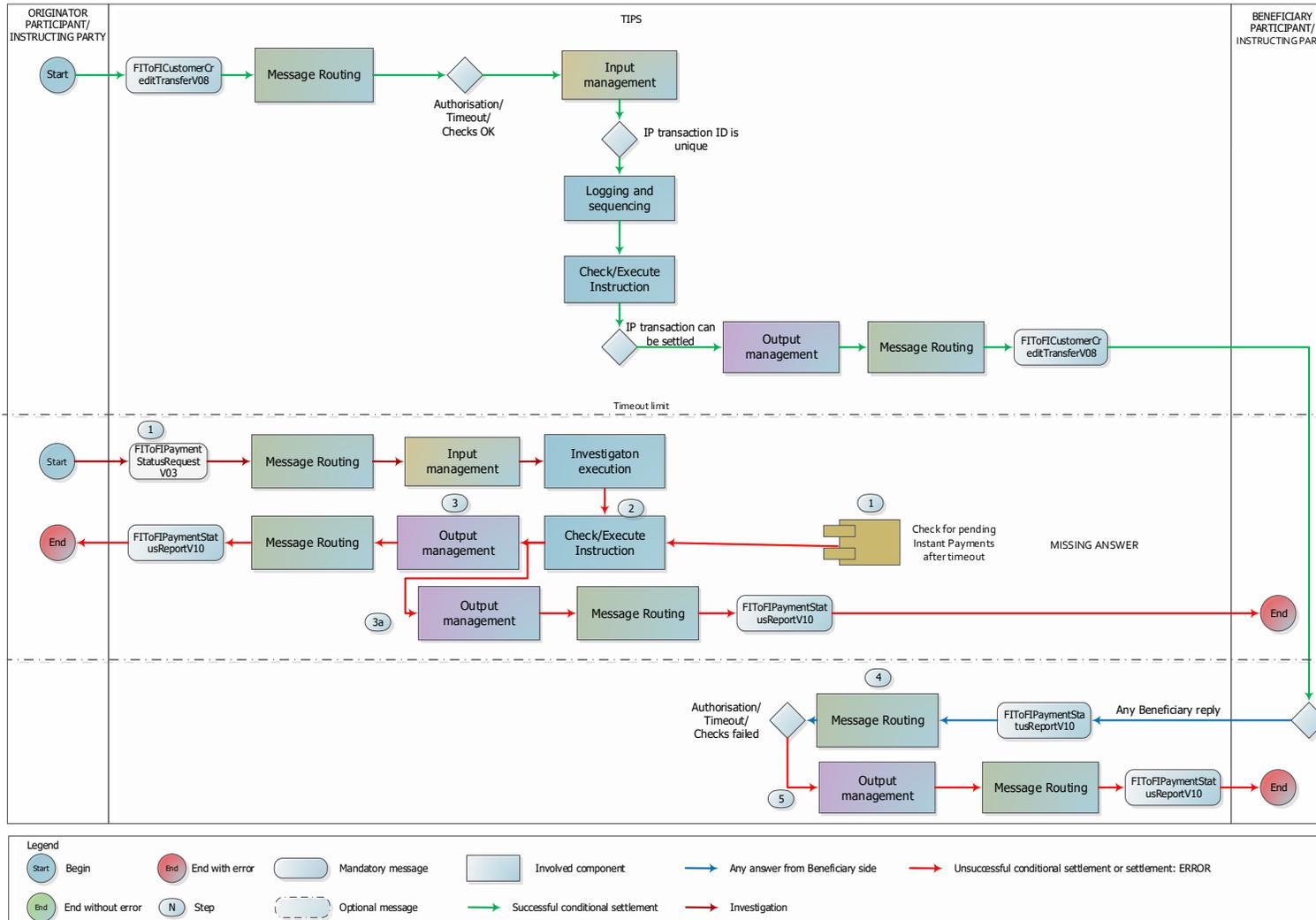

Table 59 – Instant Payment transaction missing/delayed Beneficiary-side answer steps (non-Euro currencies)

| Step | Involved messages | Involved actors | Description |
|------|---|---|---|
| 1 | | TIPS | Every X seconds, with "X" being defined in the " Sweeping timeout " parameter, the Sweeping service runs checking all the payment in status " <i>Reserved</i> ". If the "Acceptance timestamp" of the payment has exceeded the "Timestamp Timeout" value, the payment is elected for sweeping. |
| 1 | FIToFIPaymentStatusRequest | Originator Participant, Ancillary System or Instructing Party as Sender TIPS as receiver | TIPS receives an incoming Investigation request from the Originator Participant, Ancillary System or Instructing Party. There is no existing generated payment transaction status advice for the transaction and no answer from Beneficiary side has reached TIPS. |
| 2 | | TIPS< | TIPS executes these operations for each orphan payment: - TIPS retrieves the transaction to be rejected and its ID executing the check " Timeout Check - Missing answer " (see 4.1- Business Rules for details); - The transaction is set to " <i>Expired</i> " status; - The reserved amount is released in the involved Originator Account and the possibly involved Debiting CMB is increased by the same amount TIPS always releases the reserved transactions even if the involved account or CMB have been blocked in the meantime. |
| 3 | FIToFIPaymentStatusReport (pacs.002.001.10) | TIPS as sender Originator Participant, Ancillary System or Instructing Party as receiver | TIPS sends a message to the Originator Participant or Instructing Party – same DN of the Sender taken from the transaction under analysis. The FIToFIPaymentStatusReport contains the Transaction ID of the transaction and the proper error code. |
| 3a | FIToFIPaymentStatusReport (pacs.002.001.10) | TIPS as sender Beneficiary Participant or Instructing Party as receiver | TIPS sends a message to the Beneficiary Participant or Instructing Party identified as the default DN in the entity "Outbound DN-BIC Routing" related to the Beneficiary BIC in the transaction under analysis. The FIToFIPaymentStatusReport contains the Transaction ID of the transaction and the proper error code. |

| Step | Involved messages | Involved actors | Description |
|------|---|--|--|
| 4 | | TIPS | TIPS unsuccessfully executes the check: - Pending transaction existing . See 4.1- Business Rules for details. |
| 5 | FIToFIPaymentStatusReport (pacs.002.001.10) | TIPS as sender Beneficiary Participant or Instructing Party as receiver | TIPS sends a FIToFIPaymentStatusReport (pacs.002.001.10) message to the Beneficiary Participant or Instructing Party (DN of the sender of the message) containing the proper error code. |

2.2.2.2. Examples (non-Euro currencies scheme)

This sub-section includes a not exhaustive list of examples of TIPS transactions in non-Euro currencies and related messages.

Each example is introduced by a description of the involved actors and involved messages and it highlights how the balances change in the accounts.

All the examples are based on the data constellation introduced below. The data constellation is depicted on the basis of the concepts introduced in [1.3.2 "Accounts structure and organisation"](#).

Figure 62 – Instant Payment transaction examples data constellation for non-Euro currencies

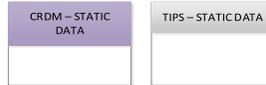
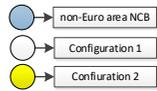

| CASH ACCOUNT | | | | | |
|---------------|------------------|------------|------------|--------------|----------------|
| ACCOUNT | TIPS PARTICIPANT | VALID FROM | VALID TO | FLOOR AMOUNT | CEILING AMOUNT |
| ACCOUNT1 | PRTYABSSXXX | 23/05/2022 | 31/12/9999 | 50.000 SEK | 50.000.000 SEK |
| ACCOUNT2 | PRTYBCSSXXX | 23/05/2022 | 31/12/9999 | 30.000 SEK | 70.000.000 SEK |
| ACCOUNT3 | PRTYBCSSXXX | 23/05/2022 | 31/12/9999 | 10.000 SEK | 60.000.000 SEK |
| TRANACC - SEK | NCBOSEKXXXX | 23/05/2022 | 31/12/9999 | | |

| CMBs | | | | | | | |
|------|----------|------------------|------------|------------|--------------|----------------|------------|
| CMB | ACCOUNT | TIPS PARTICIPANT | VALID FROM | VALID TO | FLOOR AMOUNT | CEILING AMOUNT | LIMIT |
| CMB1 | ACCOUNT1 | PRTYABSSXXX | 23/05/2022 | 31/12/9999 | 10.000 SEK | 40.000 SEK | 50.000 SEK |
| CMB2 | ACCOUNT2 | PRTYBCSSXXX | 23/05/2022 | 31/12/9999 | 5.000 SEK | 20.000 SEK | 25.000 SEK |

| CRDM – STATIC DATA | |
|--|---------------------------|
| DN | PARENT BIC – PARTY BIC |
| <ou=dept_ab, o=prtyabsxxx, o=a2anet> | NCBOSEKXXXX - PRTYABSSXXX |
| <ou=dept_ab, o=prtyabs123, o=a2anet> | NCBOSEKXXXX - PRTYABSS123 |
| <ou=dept_ab, o=prtyabs234, o=a2anet> | NCBOSEKXXXX - PRTYABSS234 |
| <ou=dept_bc, o=prtybcssxxx, o=a2anet> | NCBOSEKXXXX - PRTYBCSSXXX |
| <ou=dept_bc, o=prtybcss123, o=a2anet> | NCBOSEKXXXX - PRTYBCSS123 |
| <ou=dept_bc, o=prtybcss234, o=a2anet> | NCBOSEKXXXX - PRTYBCSS234 |
| <ou=dept_ncb, o=ncbosekxxxx, o=a2anet> | TRGTXPXXXX - NCBOSEKXXXX |

| Inbound DN BIC ROUTING | |
|--|-------------|
| DN | ACTOR |
| <ou=dept_ab, o=prtyabsxxx, o=a2anet> | PRTYABSSXXX |
| <ou=dept_ab, o=prtyabs123, o=a2anet> | PRTYABSS123 |
| <ou=dept_ab, o=prtyabsxxx, o=a2anet> | PRTYABSS123 |
| <ou=dept_ab, o=prtyabs234, o=a2anet> | PRTYABSS123 |
| <ou=dept_ab, o=prtyabs234, o=a2anet> | PRTYABSS234 |
| <ou=dept_ab, o=prtyabsxxx, o=a2anet> | PRTYABSS234 |
| <ou=dept_bc, o=prtybcssxxx, o=a2anet> | PRTYBCSSXXX |
| <ou=dept_bc, o=prtybcss123, o=a2anet> | PRTYBCSS123 |
| <ou=dept_bc, o=prtybcssxxx, o=a2anet> | PRTYBCSS123 |
| <ou=dept_bc, o=prtybcssxxx, o=a2anet> | PRTYBCSS234 |
| <ou=dept_bc, o=prtybcss234, o=a2anet> | PRTYBCSS234 |
| <ou=dept_ncb, o=ncbosekxxxx, o=a2anet> | NCBOSEKXXXX |

| AUTHORIZED ACCOUNT USER | |
|-------------------------|-------------|
| ACCOUNT | ACTOR |
| ACCOUNT1 | PRTYABSSXXX |
| ACCOUNT1 | PRTYABSS123 |
| CMB1 | PRTYABSS234 |
| ACCOUNT2 | PRTYBCSSXXX |
| ACCOUNT3 | PRTYBCSS123 |
| CMB2 | PRTYBCSS234 |

| Outbound DN BIC ROUTING | |
|--|-------------|
| DN | ACTOR |
| <ou=dept_ab, o=prtyabsxxx, o=a2anet> | PRTYABSSXXX |
| <ou=dept_ab, o=prtyabs123, o=a2anet> | PRTYABSS123 |
| <ou=dept_ab, o=prtyabs234, o=a2anet> | PRTYABSS234 |
| <ou=dept_bc, o=prtybcssxxx, o=a2anet> | PRTYBCSSXXX |
| <ou=dept_bc, o=prtybcss123, o=a2anet> | PRTYBCSS123 |
| <ou=dept_bc, o=prtybcssxxx, o=a2anet> | PRTYBCSS234 |
| <ou=dept_ncb, o=ncbosekxxxx, o=a2anet> | NCBOSEKXXXX |

2.2.2.2.1 Successful scenario with confirmed order – only accounts involved

This positive scenario describes a successful payment transaction between two TIPS Accounts owned and held by two TIPS Participants sending the messages on their own (no Instructing Party different from the TIPS Participant(s) foreseen). “Configuration 1” and “Configuration 2” (highlighted in white and yellow in the [Figure 62 – Instant Payment transaction examples data constellation for non-Euro currencies](#)) are considered.

No errors or timeouts occur. No floor or ceiling notification expected. The current business date, in the given example, is 30/12/2022. The [FIToFICustomerCreditTransfer](#) message received by TIPS and triggering the scenario looks like the following one.

Figure 63 – Successful Instant Payment transaction: FItoFICustomerCreditTransfer

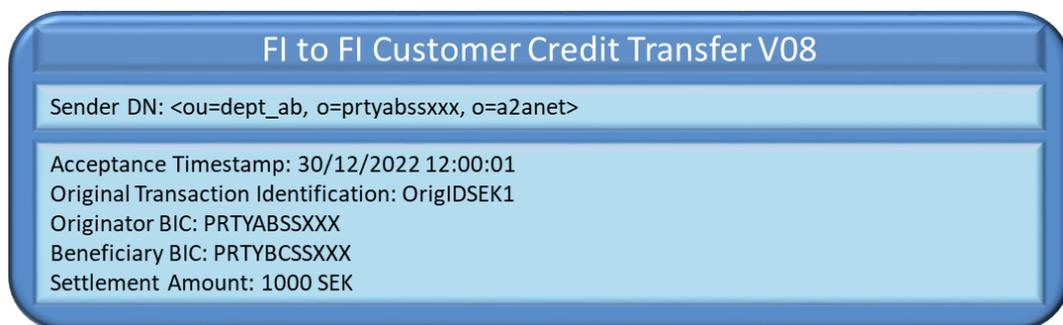

The system, after performing the expected checks successfully, sets up the settlement on the accounts as follows:

- It identifies the Originator Account (ACCOUNT1) from the Originator BIC;
- It identifies the Beneficiary Account (ACCOUNT2) from the Beneficiary BIC;
- It identifies the Beneficiary DN from the “Outbound DN-BIC Routing”
(<ou=dept_bc, o=prtybcssxxx, o=a2anet>);
- It reserves the amount in ACCOUNT1 – the new availability for ACCOUNT1 decreases from 100,000.00 SEK to 99,000.00 SEK;
- The transaction is saved and put in status *Reserved*.

The forwarding of the [FIToFICustomerCreditTransfer](#) message to the Beneficiary DN ends the Conditional Settlement phase.

Figure 64 – Successful Instant Payment transaction: reservation of funds

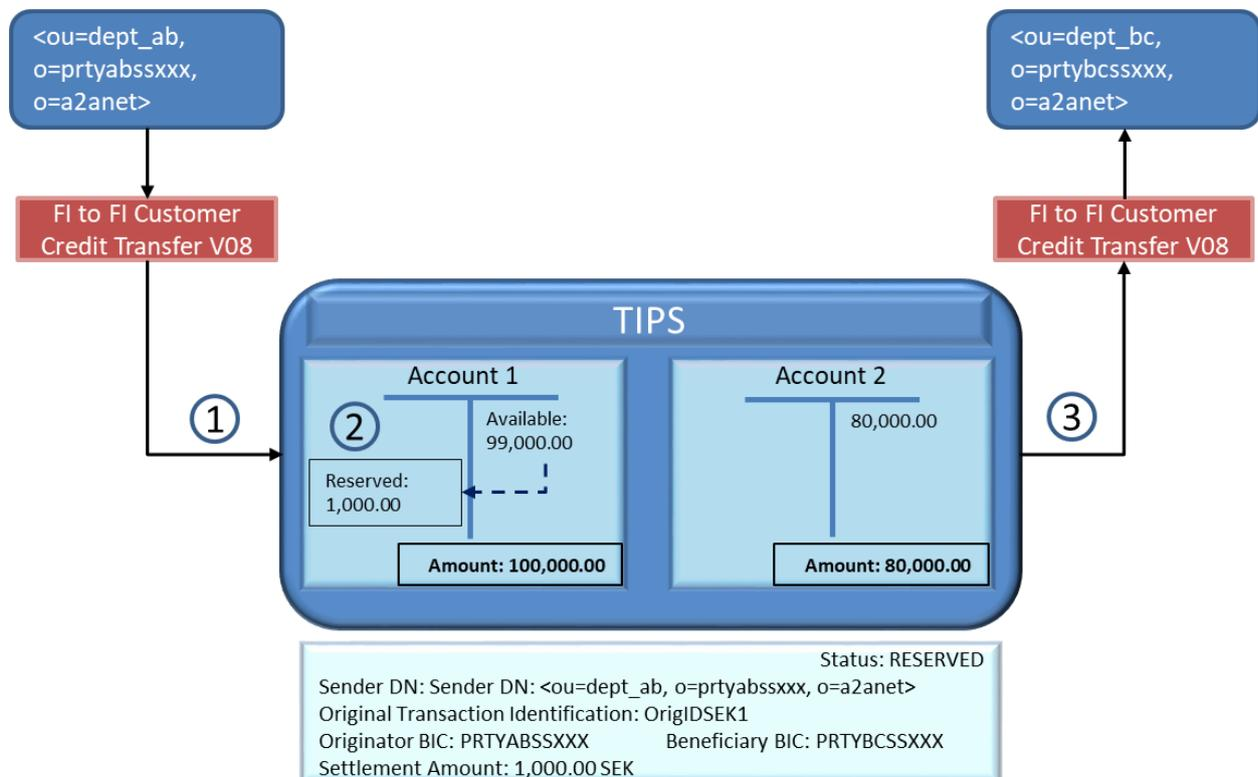

The answer from the Beneficiary triggers the settlement phase. In this scenario, the Beneficiary Bank confirms the payment by sending a [FIToFIPaymentStatusReport \(pacs.002.001.10\)](#) message with a positive answer. TIPS definitively settles the transaction, moving the amount from ACCOUNT1 to ACCOUNT2.

Figure 65 – Successful Instant Payment transaction: FIttoFIPaymentStatusReport

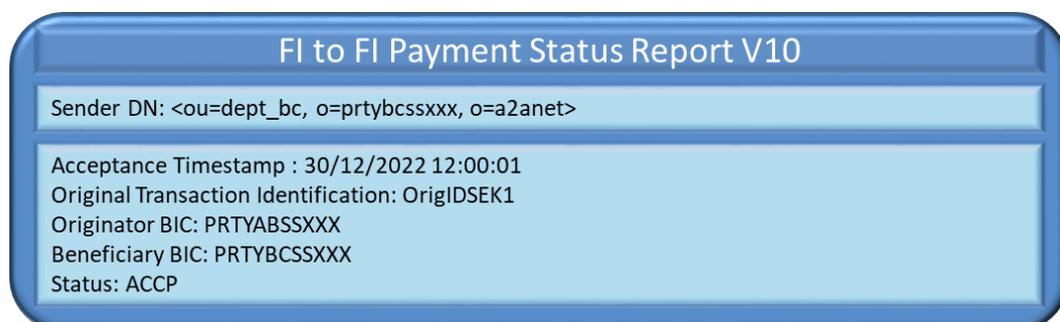

The system, after performing the expected checks successfully, finds the reserved transaction and executes the settlement on the accounts as follows:

- It identifies the transaction from the Original Transaction ID. The transaction must be in status *Reserved*.

- it identifies the Originator Account (ACCOUNT1) and the Beneficiary Account (ACCOUNT2) from the retrieved transaction;
- It identifies the Originator DN from the transaction;
- It definitively settles the amount moving the liquidity reserved in the ACCOUNT1 to the ACCOUNT2;
- The transaction status is turned into *Settled*.

TIPS then forwards the [FIToFIPaymentStatusReport \(pacs.002.001.10\)](#) message to the Originator DN and sends a confirmation message for successful settlement to the Beneficiary.

Figure 66 – Successful Instant Payment transaction: settlement phase

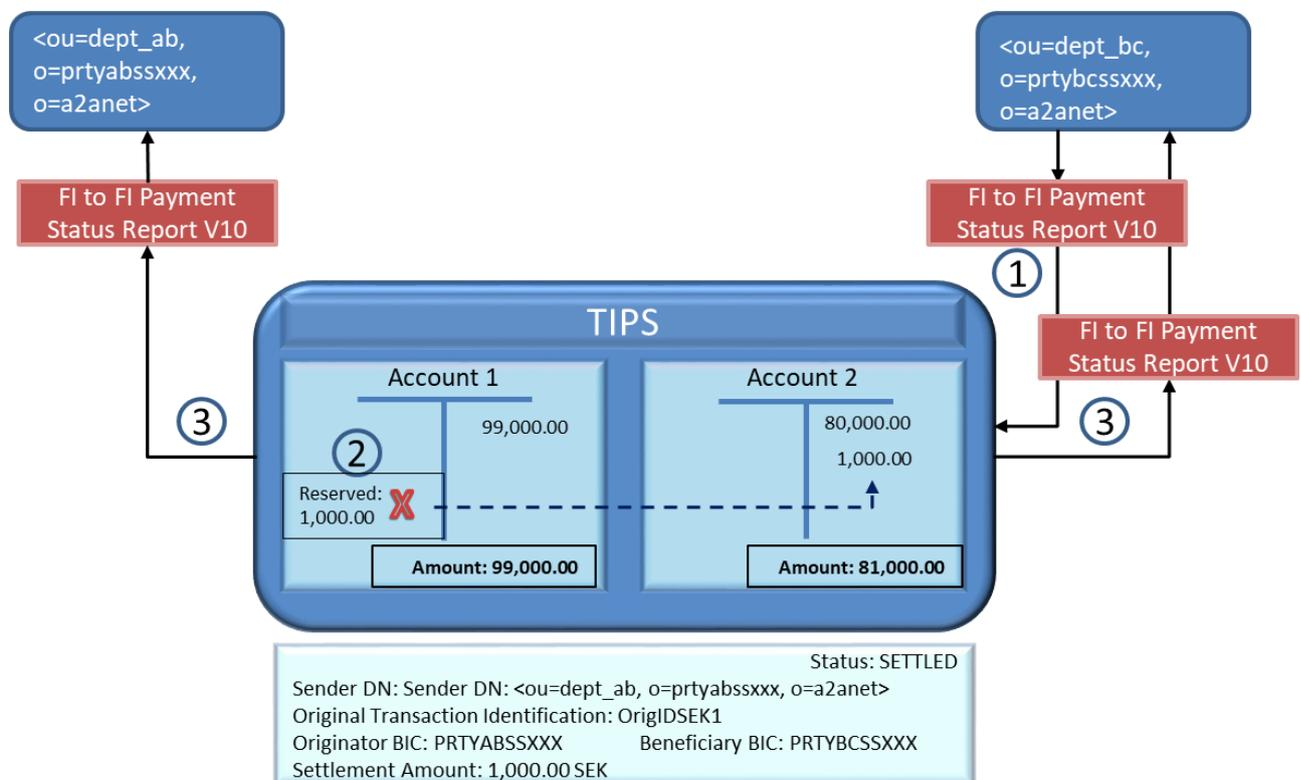

2.2.2.2 Successful scenario with confirmed order – Creditor account and debtor CMB

This positive scenario describes a successful payment transaction between a CMB held by a branch of a TIPS Participant A sending messages on its own and a TIPS Account owned by a TIPS Participant B but used by a related Reachable Party. “Configuration 1” and “Configuration 2” (highlighted in white and yellow in [Figure 62 – Instant Payment transaction examples data constellation for non-Euro currencies](#)) are considered.

No errors or timeouts occur. No floor or ceiling notification is expected. The current business date, in the given example, is 30/12/2022. The [FIToFICustomerCreditTransfer](#) message received by TIPS and triggering the scenario looks like the following one.

Figure 67 – Successful Instant Payment transaction: FItoFICustomerCreditTransfer

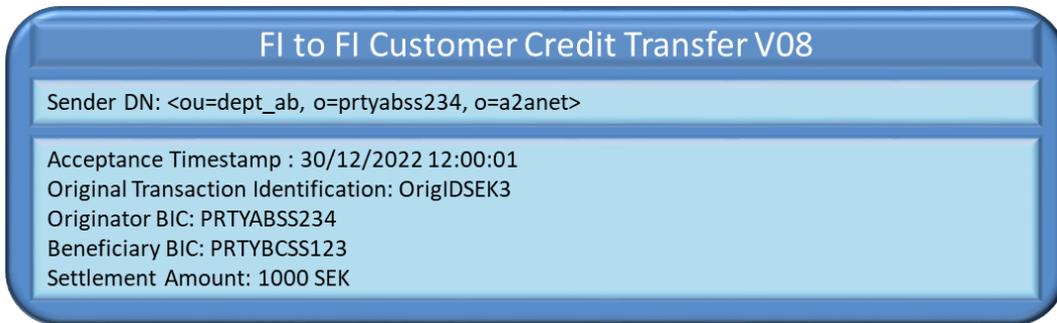

The system, after performing the expected checks successfully, sets up the settlement on the accounts and on the CMB as follows:

- It identifies the Debiting CMB (CMB1) from the Originator BIC;
- It identifies the Originator Account from the CMB1 (ACCOUNT1);
- It identifies the Beneficiary Account (ACCOUNT3) from the Beneficiary BIC;
- It identifies the Beneficiary DN from the “Outbound DN-BIC Routing” (<ou=dept_bc, o=prtybcss123, o=a2anet>);
- It decreases the headroom for the involved CMB1;
- It reserves the amount for ACCOUNT1 related to the CMB – the new availability for ACCOUNT1 decreases from 99,000.00 SEK to 98,000.00 SEK;
- The transaction is saved and put in status *Reserved*.

The forwarding of the [FIToFICustomerCreditTransfer](#) message to the Beneficiary DN ends the Conditional Settlement phase.

Figure 68 – Successful Instant Payment transaction: reservation of funds

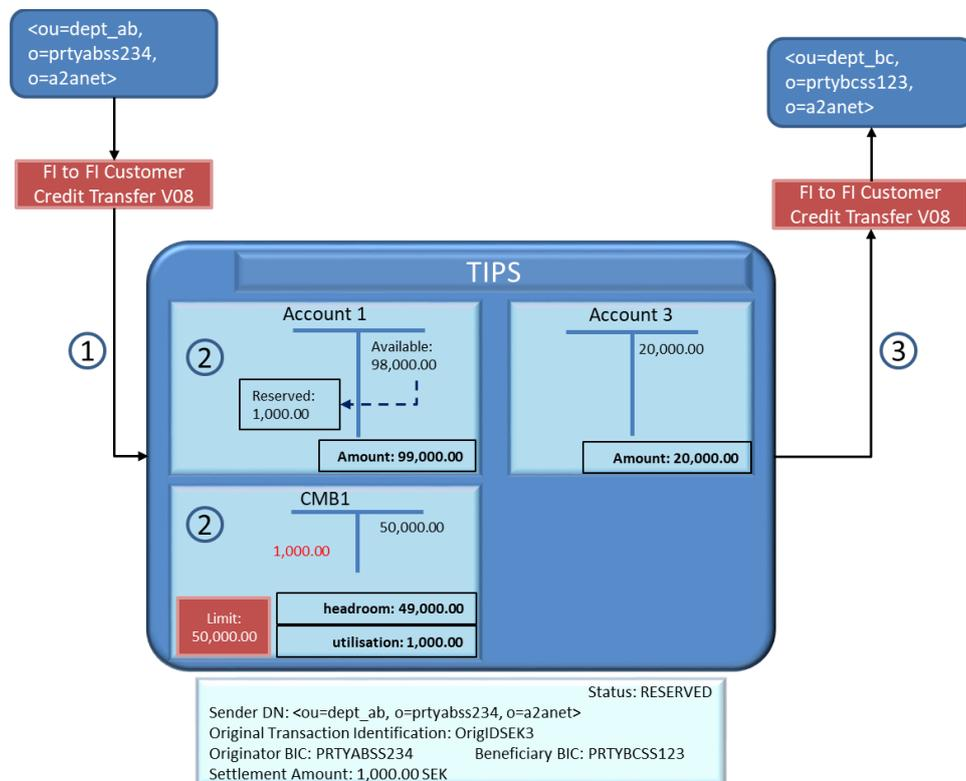

The answer from the Beneficiary Participant triggers the settlement phase. In this scenario, the Beneficiary Participant confirms the payment sending a [FIToFIPaymentStatusReport \(pacs.002.001.10\)](#) message with a positive answer. TIPS definitively settles the transaction, moving the amount from ACCOUNT1 to ACCOUNT3. The movement on CMB1 is confirmed.

Figure 69 – Successful Instant Payment transaction: FIttoFIPaymentStatusReport

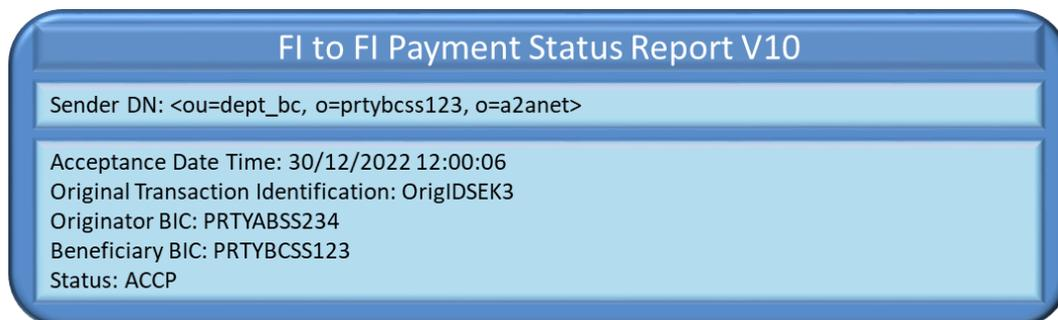

The system, after performing the expected checks successfully, finds the reserved transaction and executes the settlement on the accounts as follows:

- It identifies the transaction from the Original Transaction ID. The transaction must be in status *Reserved*.

- It identifies the Originator Account (ACCOUNT1) and the Beneficiary Account (ACCOUNT3) from the retrieved transaction;
- It identifies the Originator DN from the transaction;
- It definitively settles the amount by moving the liquidity reserved in the ACCOUNT1 to the ACCOUNT3;
- The transaction status is turned into *Settled*.

In this example, CMB1 has no additional movements – the reduction of the headroom is confirmed. The settlement phase ends and TIPS then forwards the [FIToFIPaymentStatusReport \(pacs.002.001.10\)](#) message to the Originator DN and sends a confirmation message for successful settlement to the Beneficiary Participant.

Figure 70 – Successful Instant Payment transaction: settlement phase

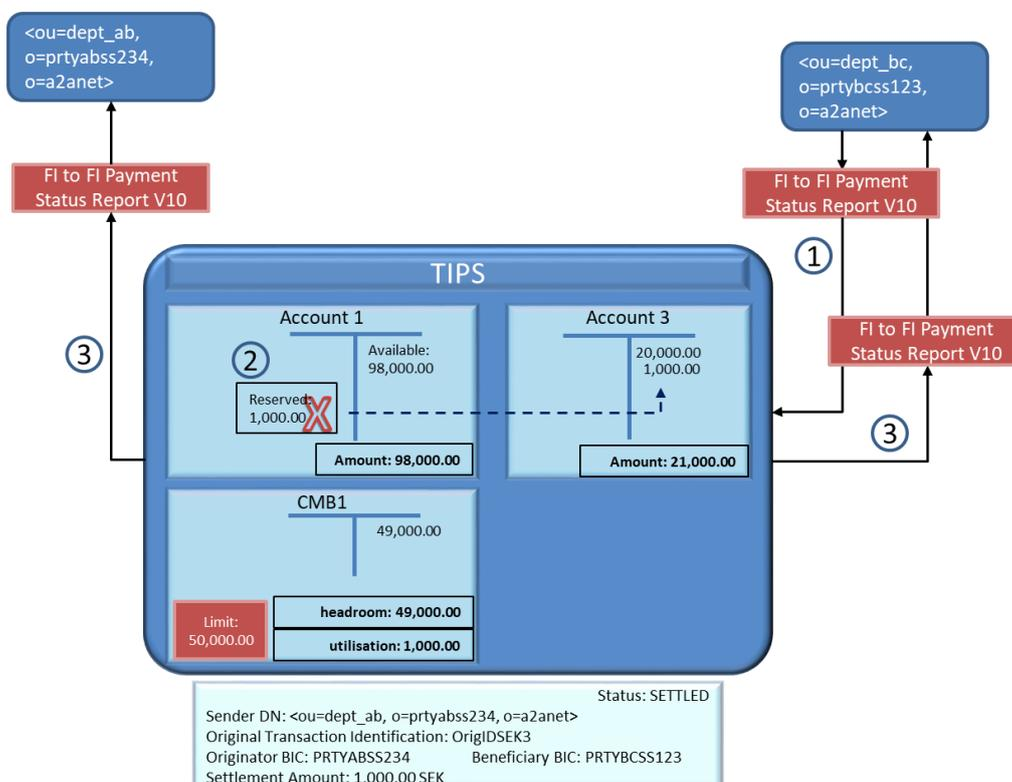

2.2.2.2.3 Successful scenario with confirmed order – Creditor CMB and debtor Account

This positive scenario describes a successful payment transaction between a TIPS Account owned and held by a TIPS Participant A sending the messages on its own and a CMB held by a branch of a TIPS Participant B. The TIPS Participant B acts as Instructing Party for its branch. “Configuration 1” and “Configuration 2” (highlighted in white and yellow in [Figure 62 – Instant Payment transaction examples data constellation for non-Euro currencies](#)) are considered.

No errors or timeouts occur. No floor or ceiling notification is expected. The current business date, in the given example, is 30/12/2022. The [FIToFICustomerCreditTransfer](#) message received by TIPS and triggering the scenario looks like the following one.

Figure 71 – Successful Instant Payment transaction: FItoFICustomerCreditTransfer

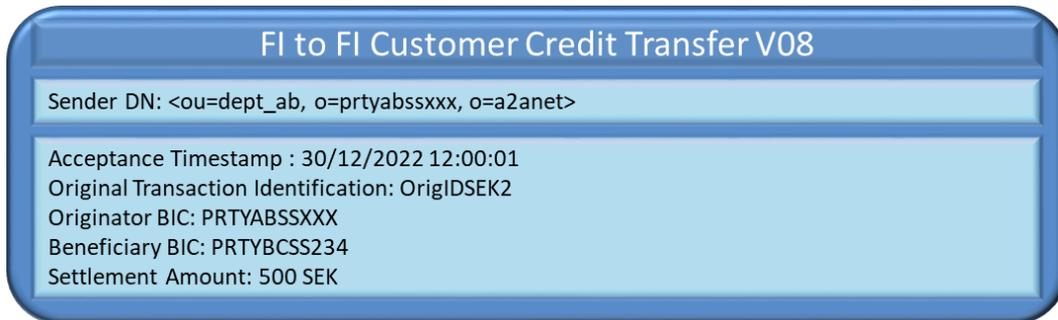

TIPS, after performing the expected checks successfully, sets up the settlement on the accounts and on the CMB as follows:

- It identifies the Originator Account (ACCOUNT1) from the Originator BIC;
- It identifies the Crediting CMB (CMB2) from the Beneficiary BIC;
- It identifies the Beneficiary Account (ACCOUNT2) from the CMB2 in table CMBs;
- It identifies the Beneficiary DN from the “Outbound DN-BIC Routing” (<ou=dept_bc, o=prtybcssxxx, o=a2anet>);
- It reserves the amount in ACCOUNT1 – the new availability for ACCOUNT1 decreases from 98,000.00 SEK to 97,500.00 SEK;
- The transaction is saved and put in status *Reserved*.

The forwarding of the [FIToFICustomerCreditTransfer](#) message to the Beneficiary DN ends the Conditional Settlement phase.

Figure 72 – Successful Instant Payment transaction: reservation of funds

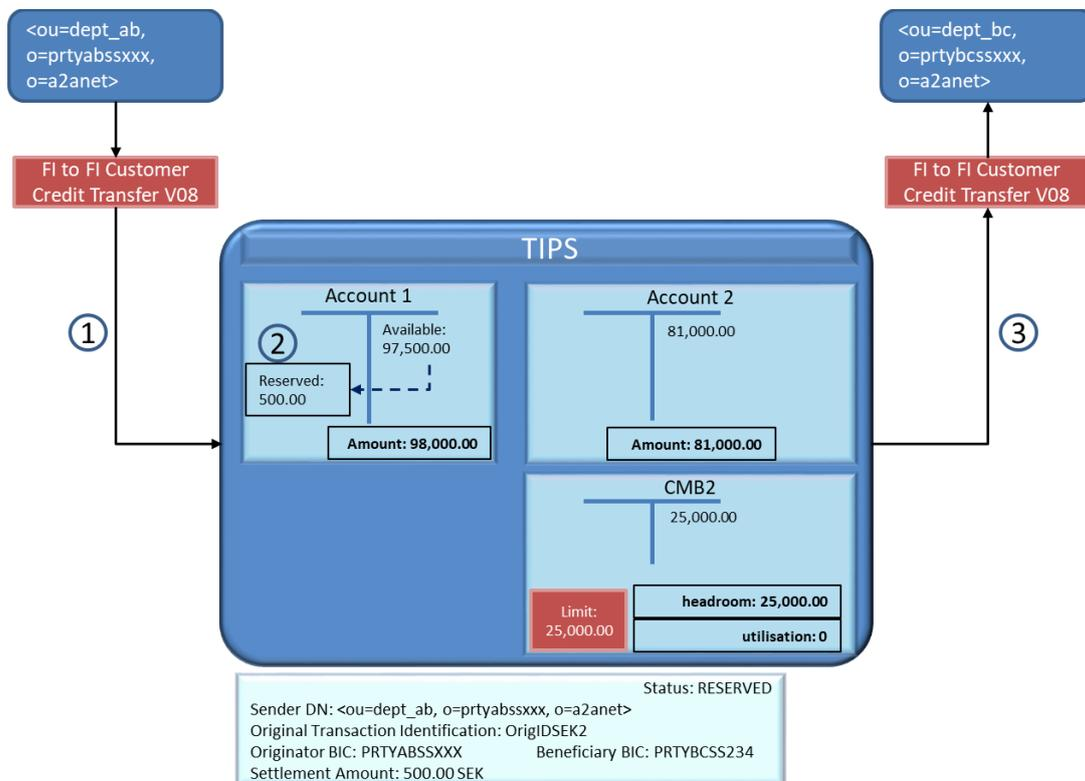

The answer from the Beneficiary Participant triggers the settlement phase. In this scenario, the Beneficiary Bank confirms the payment sending a [FIToFIPaymentStatusReport \(pacs.002.001.10\)](#) message with a positive answer. TIPS definitively settles the transaction, moving the amount from ACCOUNT1 to ACCOUNT2 and increasing the headroom for CMB2.

Figure 73 – Successful Instant Payment transaction: FIToFIPaymentStatusReport

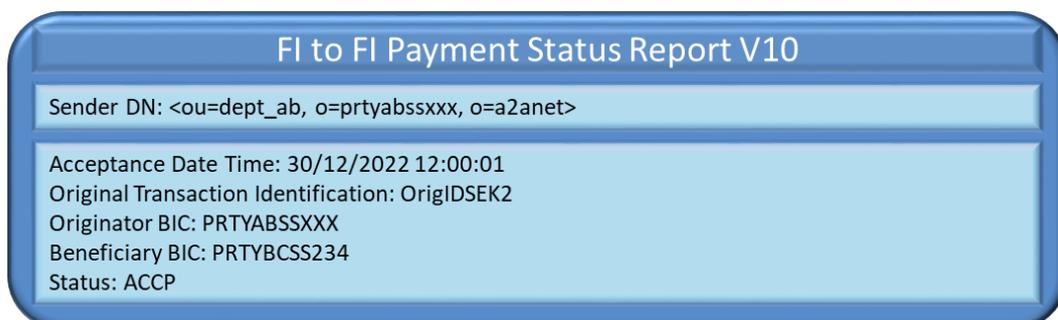

The system, after performing the expected checks successfully, finds the reserved transaction and executes the settlement on the accounts as follows:

- It identifies the transaction from the Original Transaction ID. The transaction must be in status *Reserved*.

- It identifies the Originator Account (ACCOUNT1), the Crediting CMB (CMB2) and the Beneficiary Account (ACCOUNT2) from the retrieved transaction;
- It identifies the Originator DN from the transaction;
- It definitively settles the amount moving the liquidity reserved in the ACCOUNT1 to the ACCOUNT2;
- It increases the headroom of the CMB2;
- The transaction status is turned into *Settled*.

In this example, CMB2 exceeds the defined limit for the CMB (the limit defined remains 25,000.00 SEK, the headroom is 25,000.00 SEK + 500.00 SEK = 25,500.00 SEK and the utilisation is – 500.00 SEK as depicted in [Figure 74 – Successful Instant Payment transaction: settlement](#). The settlement phase ends and TIPS then forwards the [FIToFIPaymentStatusReport \(pacs.002.001.10\)](#) message to the Originator DN and sends a confirmation message for successful settlement to the Beneficiary Participant.

Figure 74 – Successful Instant Payment transaction: settlement phase

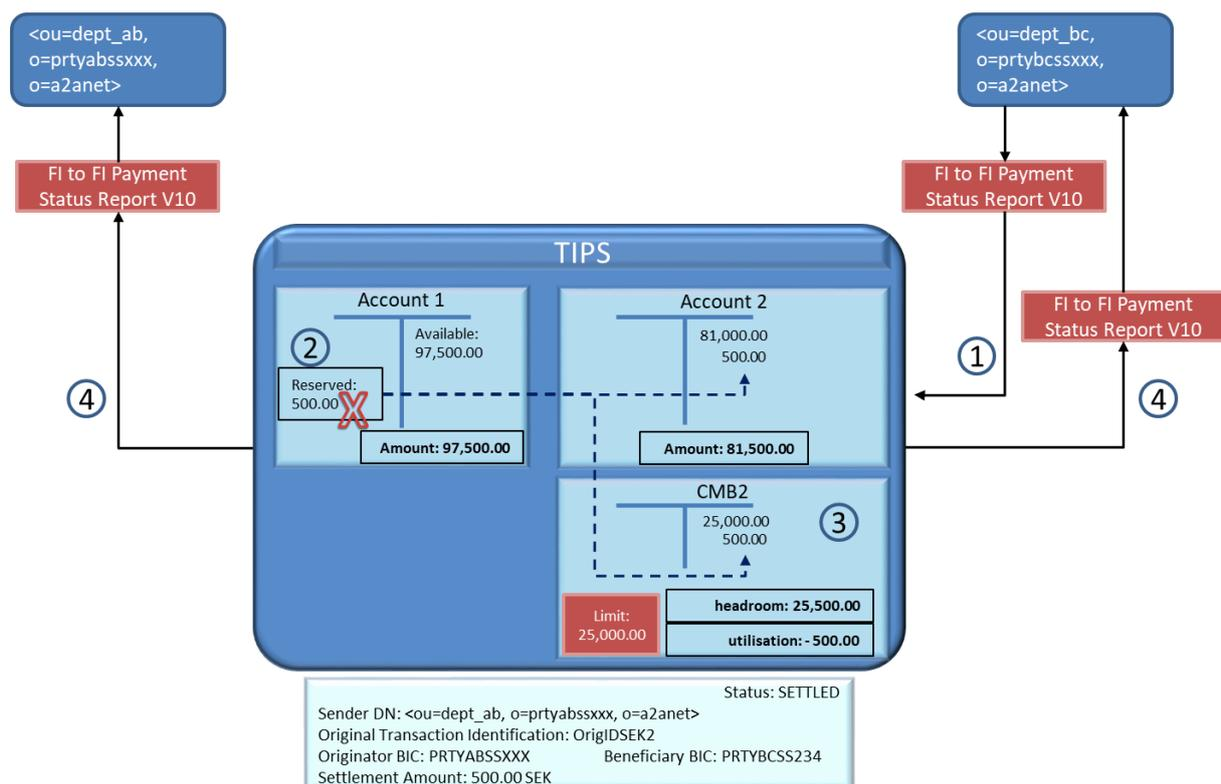

2.2.2.2.4 Successful scenario with rejected order

This negative scenario describes a successful reservation of funds for a transaction between a CMB held by a branch of a TIPS Participant A sending messages on its own and a TIPS Account owned by

a TIPS Participant B. “Configuration 1” and “Configuration 2” (highlighted in white and yellow in [Figure 62 – Instant Payment transaction examples data constellation for non-Euro currencies](#)) are considered.

After the successful reservation, the Beneficiary participant rejects the payment.

The [FIToFICustomerCreditTransfer](#) message received by TIPS and triggering the scenario looks like the following one.

Figure 75 – Rejected Instant Payment transaction: FIToFICustomerCreditTransfer

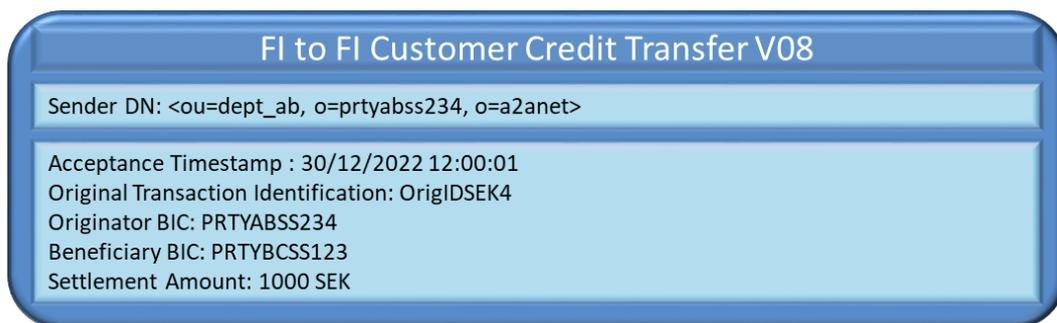

The system, after performing the expected checks successfully, sets up the settlement on the accounts and on the CMB as follows:

- It identifies the Debiting CMB (CMB1) from the Originator BIC;
- It identifies the Originator Account from the CMB1 (ACCOUNT1);
- It identifies the Beneficiary Account (ACCOUNT3) from the Beneficiary BIC;
- It identifies the Beneficiary DN from the “Outbound DN-BIC Routing” (<ou=dept_bc, o=prtybcss123, o=a2anet>);
- It decreases the headroom for the involved CMB1;
- It reserves the amount for the ACCOUNT1 related to the CMB;
- The transaction is saved and put in status *Reserved*.

The forwarding of the [FIToFICustomerCreditTransfer](#) message to the Beneficiary DN ends the Conditional Settlement phase.

Figure 76 – Rejected Instant Payment transaction: reservation of funds

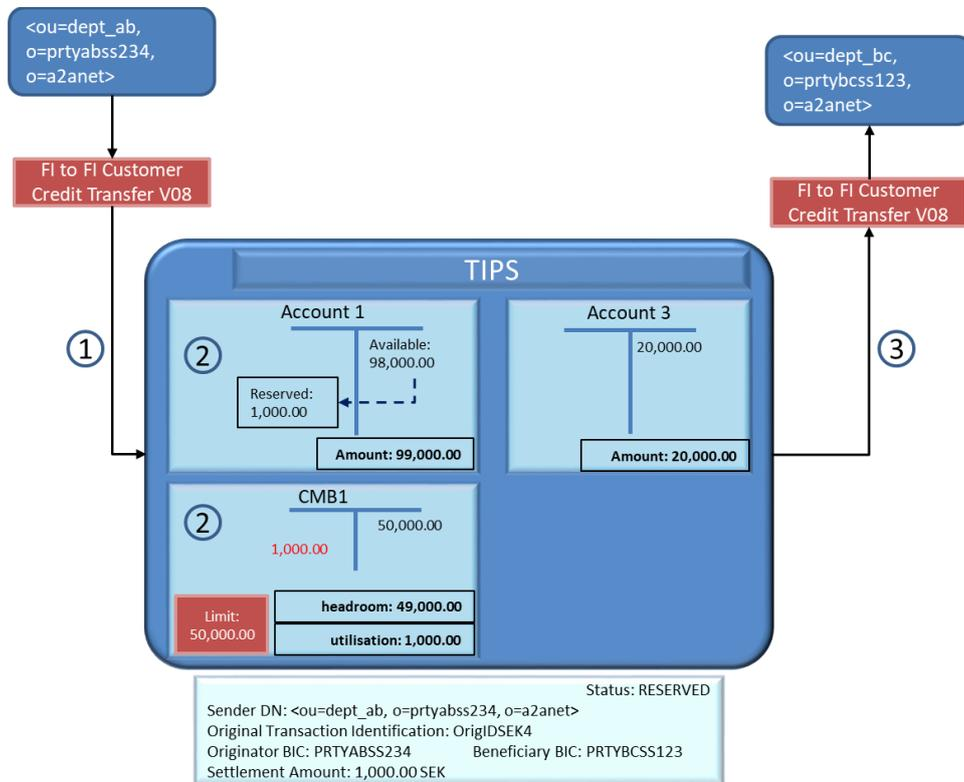

In this scenario, the Beneficiary Participant receives the forwarded [FIToFICustomerCreditTransfer](#) message with the transaction. The Beneficiary Participant rejects the payment sending a [FIToFIPaymentStatusReport \(pacs.002.001.10\)](#) message with a negative answer.

The answer from the Beneficiary Participant triggers the settlement phase for a negative scenario³⁵. TIPS must then increase the CMB1 headroom of the same amount of the payment and release the amount on ACCOUNT1.

Figure 77 – Rejected Instant Payment transaction: FItoFIStatusReport

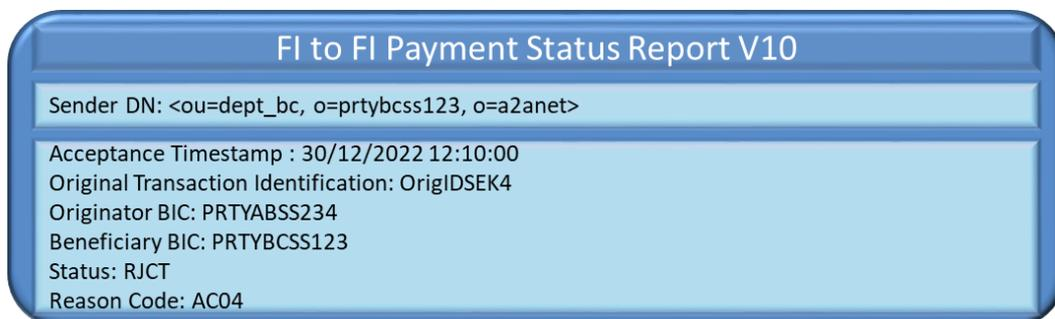

³⁵ The error code AC04 is used as an example in [Figure 75](#), however the message can contain any error code sent by the beneficiary side.

The system performs the expected checks successfully. The timeout check is not performed: a negative response from the Beneficiary side must always reach the Originator side with no changes and trigger the release of the previously reserved funds.

TIPS finds the reserved transaction, releases the funds on the accounts and increases the CMB1 headroom as follows:

- It identifies the transaction from the Original Transaction ID. The transaction must be in status *Reserved*.
- It identifies the Originator Account (ACCOUNT1) from the retrieved transaction;
- It releases the amount on the ACCOUNT1 and adds the same amount of the payment to CMB1;
- The transaction status is turned into *Rejected*;
- It identifies the Originator DN from the transaction.

The settlement phase ends with the rejection of the payment and TIPS then forwards the [FIToFIPaymentStatusReport \(pacs.002.001.10\)](#) message to the Originator DN.

Figure 78 – Rejected Instant Payment transaction: release of funds

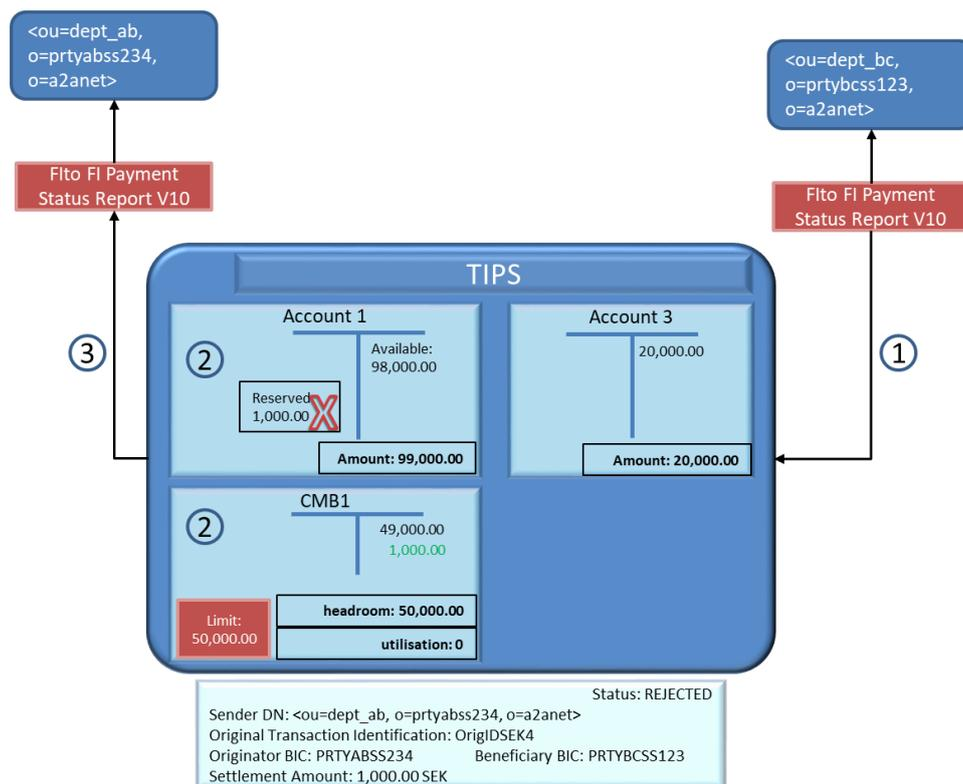

2.2.2.2.5 Error scenarios

This section describes some possible error scenarios that can happen when dealing with Instant Payment in non-Euro currencies. This is a subset of possible error cases but the error mechanism is always the same.

For the complete list of possible error codes, see [4.2 “List of Error codes”](#).

Insufficient funds within the CMB

This error scenario describes a payment transaction between a CMB held by a branch of a TIPS Participant A sending messages on its own and a TIPS Account owned by a TIPS Participant. “Configuration 1” and “Configuration 2” (highlighted in white and yellow in [Figure 62 – Instant Payment transaction examples data constellation for non-Euro currencies](#)) are considered.

The transaction fails since the requested amount exceeds the headroom of the involved CMB.

The [FIToFICustomerCreditTransfer](#) message received by TIPS and triggering the scenario looks like the following one:

Figure 79 – Headroom error: FIttoFICustomerCreditTransfer

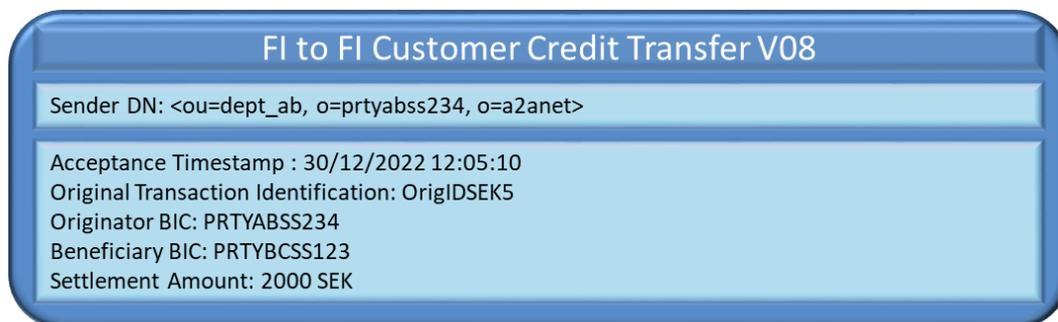

The system executes these steps:

- It identifies the Debiting CMB (CMB1) from the Originator BIC;
- It identifies that the headroom for the involved CMB1 is lower than the request amount;
- The transaction fails. The attempt is saved as failed transaction and the sender is informed of the error.

Figure 80 – Headroom error: transaction failed

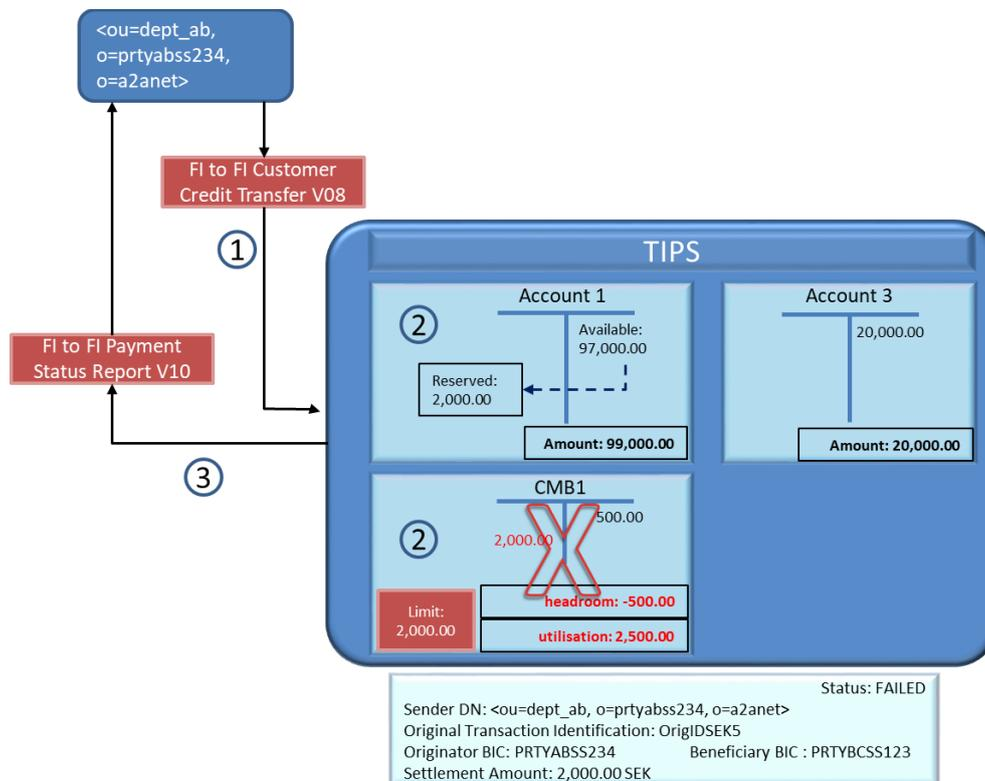

TIPS then sends a [FIToFIPaymentStatusReport \(pacs.002.001.10\)](#) to the sender with the proper error code.

Figure 81 – Headroom error: FItoFIPaymentStatusReport



Blocked Account

This error scenario describes a payment transaction between two TIPS Accounts owned and held by two TIPS Participants sending the messages on their own (no Instructing Party different from the TIPS Participant(s) foreseen). “Configuration 1” and “Configuration 2” (highlighted in white and yellow in [Figure 62 – Instant Payment transaction examples data constellation for non-Euro currencies](#)) are considered.

The transaction fails since the account to be debited is blocked and not available for settlement.

The [FIToFICustomerCreditTransfer](#) message received by TIPS and triggering the scenario looks like the following one.

Figure 82 – Blocked account error: FItoFICustomerCreditTransfer

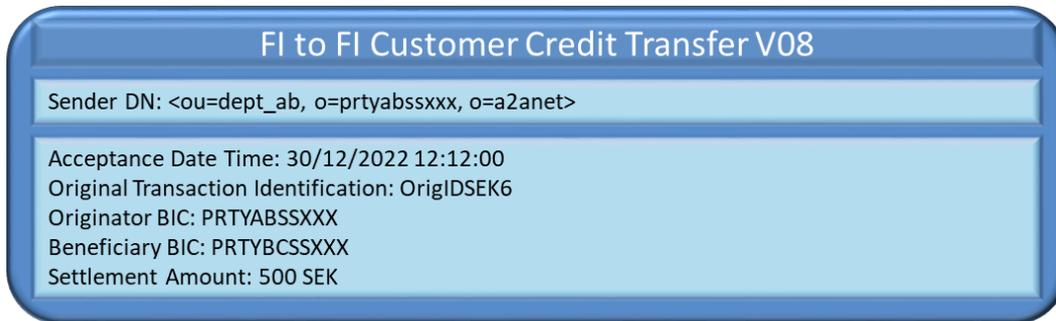

The system executes these steps:

- It identifies the Debiting Account (ACCOUNT1) from the Originator BIC;
- It detects that ACCOUNT1 is blocked (e.g. status is either 'blocked for debit' or 'blocked for credit and debit');
- The transaction fails. The attempt is saved as failed Instant Payment transaction and the sender is informed of the error.

Figure 83 – Blocked account error: transaction failed

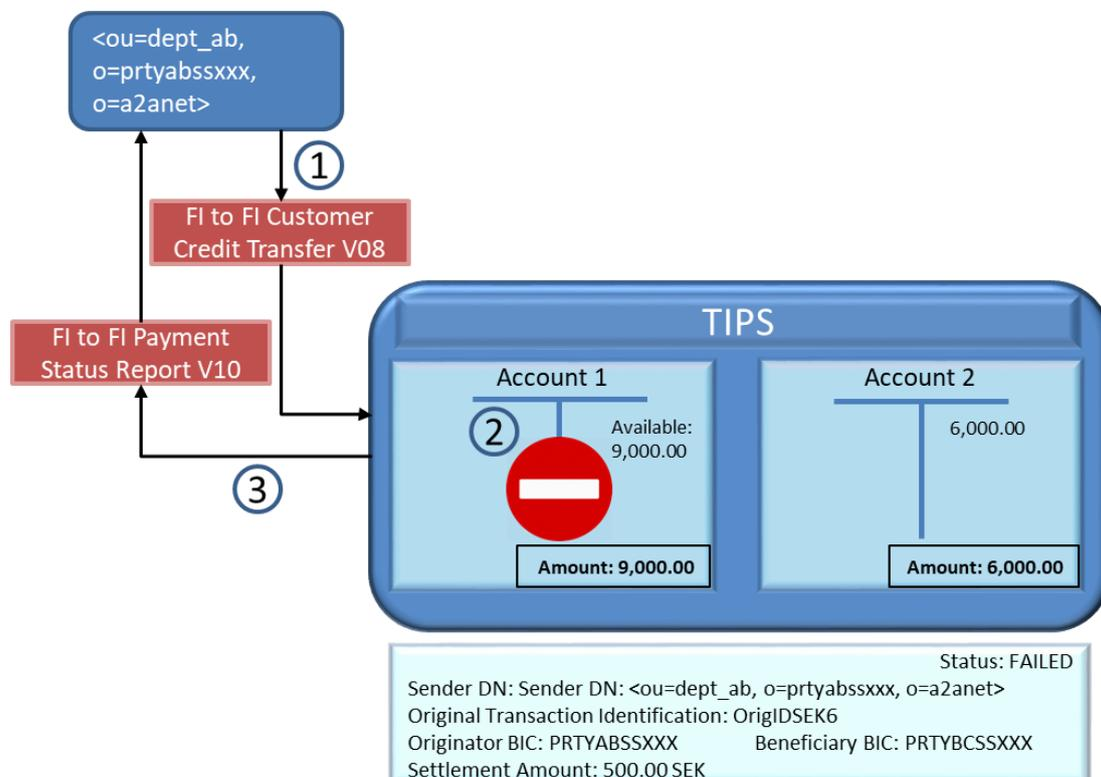

TIPS then sends a [FIToFIPaymentStatusReport \(pacs.002.001.10\)](#) to the sender with the proper error code.

Figure 84 – Blocked account error: FItoFIPaymentStatusReport

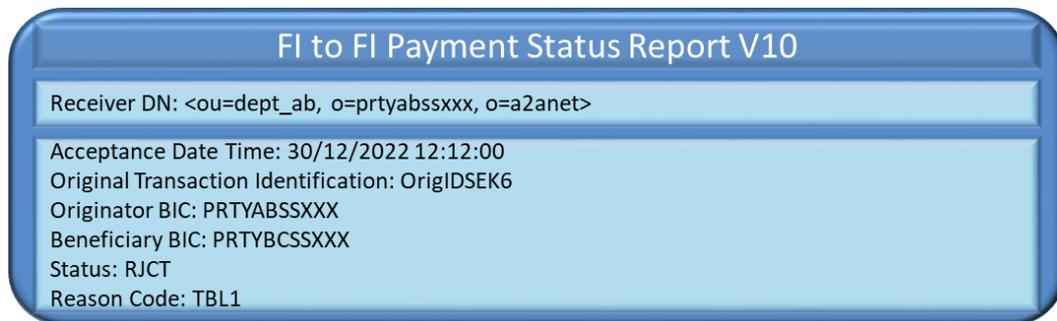

Beneficiary side timeout

This error scenario describes a payment transaction between a CMB held by a branch of a TIPS Participant A sending messages on its own and a TIPS Account owned by a TIPS Participant. “Configuration 1” and “Configuration 2” (highlighted in white and yellow in [Figure 62 – Instant Payment transaction examples data constellation for non-Euro currencies](#)) are considered.

The transaction fails since the answer from the Beneficiary Participant reaches TIPS after the foreseen timeout period.

The [FIToFICustomerCreditTransfer](#) message received by TIPS and triggering the scenario is shown in the following diagram.

Figure 85 – Beneficiary side timeout error: FItoFICustomerCreditTransfer

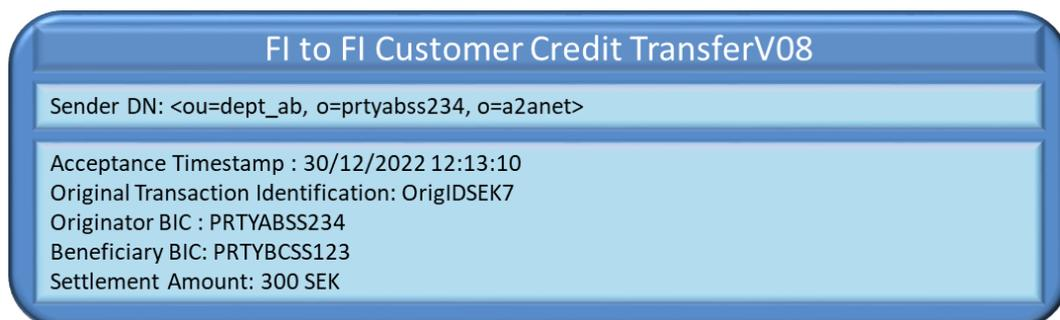

The system, after performing the expected checks successfully, sets up the settlement on the accounts and on the CMB as follows:

- It identifies the Debiting CMB (CMB1) from the Originator BIC;
- It identifies the Originator Account from the CMB1 (ACCOUNT1);
- It identifies the Beneficiary Account (ACCOUNT3) from the Beneficiary BIC;
- It identifies the Beneficiary DN from the “Outbound DN-BIC Routing (<ou=dept_bc, o=prtybcss123, o=a2anet>);

- It decreases the headroom for the involved CMB1;
- It reserves the amount for the ACCOUNT1 related to the CMB – the new availability for ACCOUNT1 decreases from 98,300.00 SEK to 98,000.00 SEK;
- The transaction is saved and put in status *Reserved*.

The forwarding of the [FIToFICustomerCreditTransfer](#) message to the Beneficiary DN ends the Conditional Settlement phase.

Figure 86 – Beneficiary side timeout error: reservation of funds

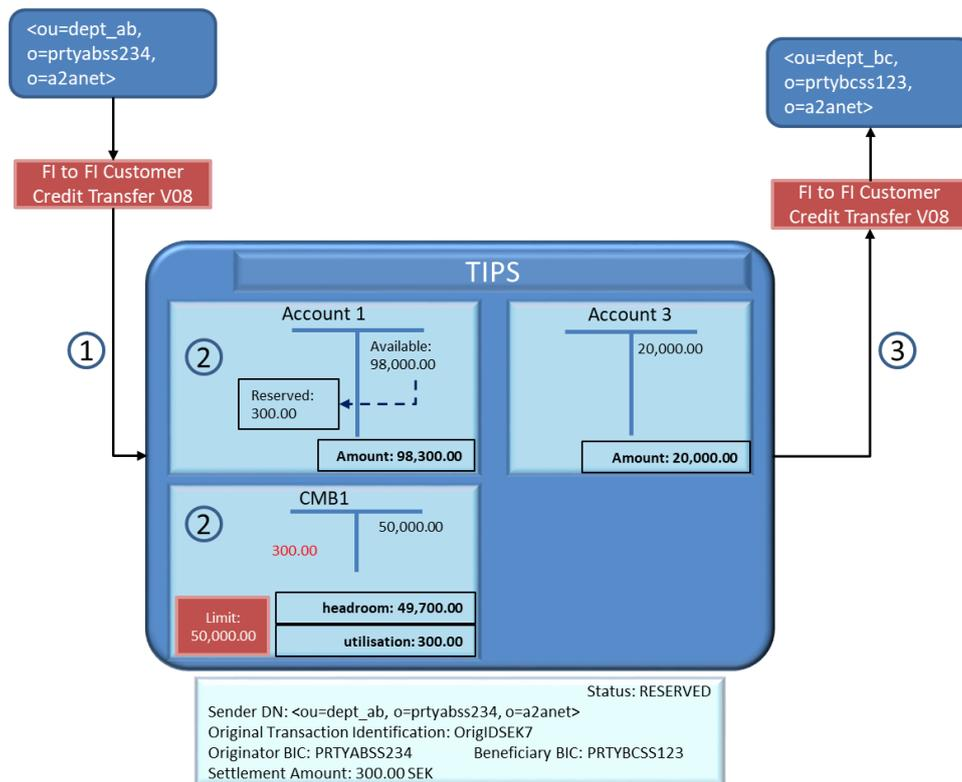

The answer from the Beneficiary Participant arrives when the timeout period is exceeded.

Figure 87 – Beneficiary side timeout error: FItoFIPaymentStatusReport

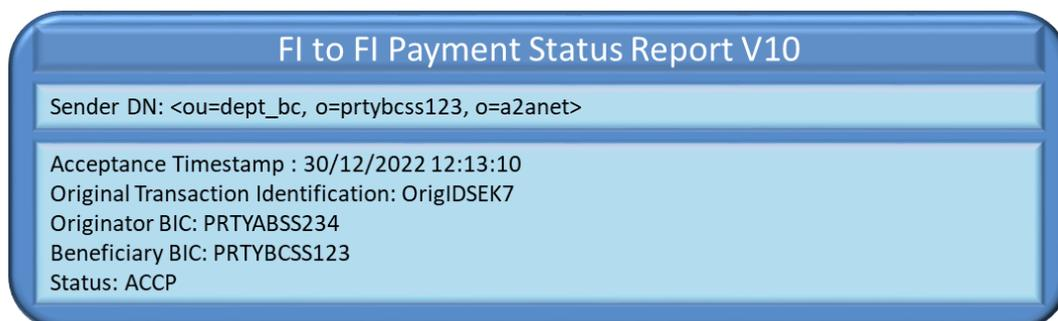

The timeout check on Beneficiary Participant side fails. TIPS finds the reserved transaction, releases the funds on the accounts and increases the CMB1 headroom as follows:

- It identifies the transaction from the Original Transaction ID. The transaction must be in status *Reserved*;
- It identifies the Originator Account (ACCOUNT1) from the retrieved transaction;
- It releases the amount on the ACCOUNT1 and adds the same amount of the payment to CMB1;
- The transaction status is turned into *Expired*;
- It identifies the Originator DN from the transaction.

Figure 88 – Beneficiary side timeout error: release of funds

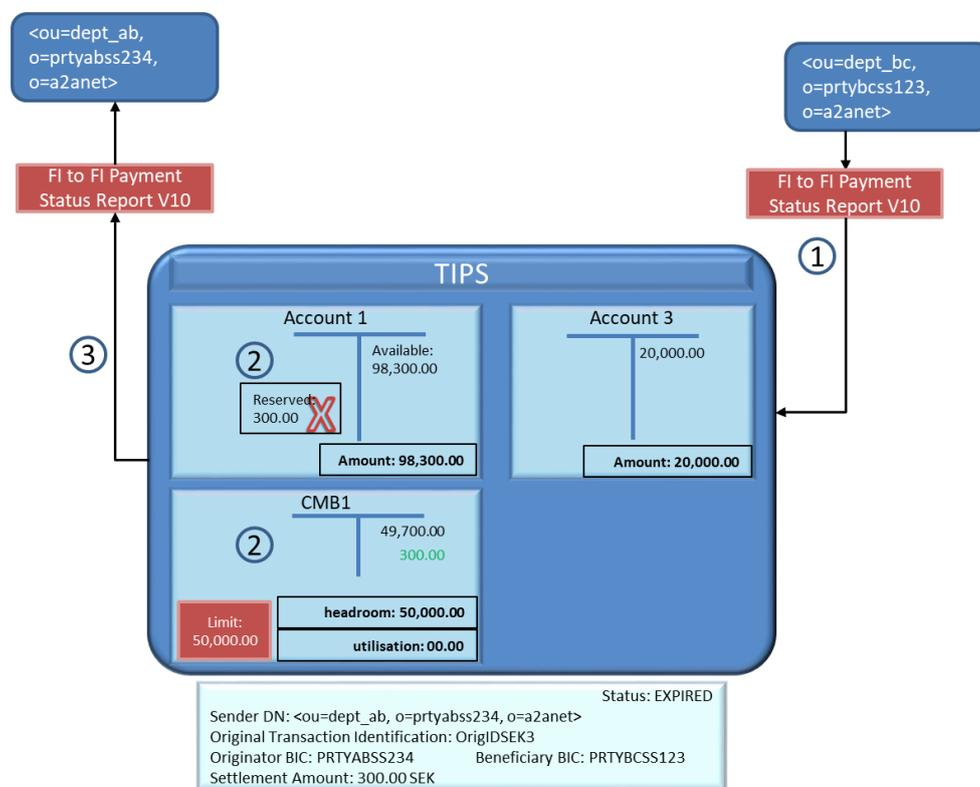

TIPS informs both sides of the transaction about the expiration. TIPS sends the message to:

- The DN of the sender of the Instant Payment transaction;
- The Beneficiary DN as configured in the “Outbound DN-BIC Routing (<ou=dept_abc, o=prtybcm123, o=a2anet>);
- The message for the Originator Participant (reason code equal to AB05) and the Beneficiary Participant (reason code equal to TM01) are respectively generated and sent as shown in the following diagram.

Figure 89 – Beneficiary side timeout error: FItoFIStatusReport



2.2.2.2.6 Delayed Beneficiary-side answer scenario

This error scenario describes a payment transaction between two TIPS Accounts owned and held by two TIPS Participants sending the messages on their own (no Instructing Party different from the TIPS Participant(s) foreseen). “Configuration 1” and “Configuration 2” (highlighted in white and yellow in in [Figure 62 – Instant Payment transaction examples data constellation for non-Euro currencies](#)) are considered.

In this scenario, the confirmation message from the Beneficiary Participant is delayed and, in the meantime, the Sweeper rejects the pending payment.

The [FIToFICustomerCreditTransfer](#) message received by TIPS and triggering the scenario looks like the following one.

Figure 90 – Delayed Beneficiary-side answer: FItoFICustomerCreditTransfer

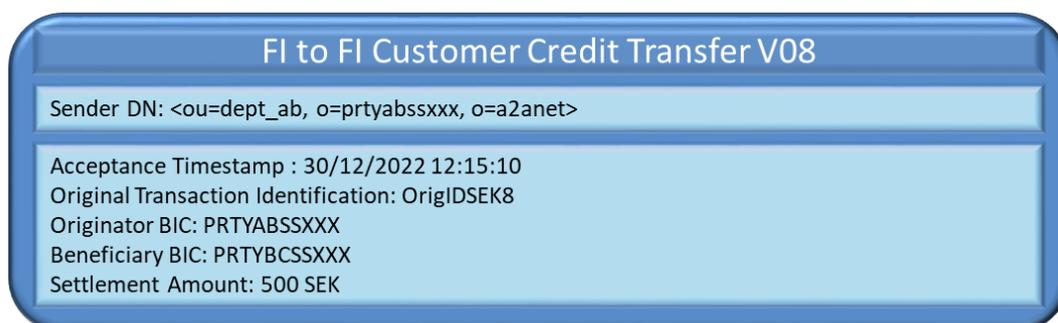

The system, after performing the expected checks successfully, sets up the settlement on the accounts as follows:

- It identifies the Originator Account (ACCOUNT1) from the Originator BIC;
- It identifies the Beneficiary Account (ACCOUNT2) from the Beneficiary BIC;
- It identifies the Beneficiary DN from the “Outbound DN-BIC Routing” (<ou=dept_bc, o=prtybcssxxx, o=a2anet>);
- It reserves the amount in ACCOUNT1;
- The transaction is saved and put in status *Reserved*.

The forwarding of the [FIToFICustomerCreditTransfer](#) message to the Beneficiary DN ends the Conditional Settlement phase.

Figure 91 – Delayed Beneficiary-side answer: reservation of funds

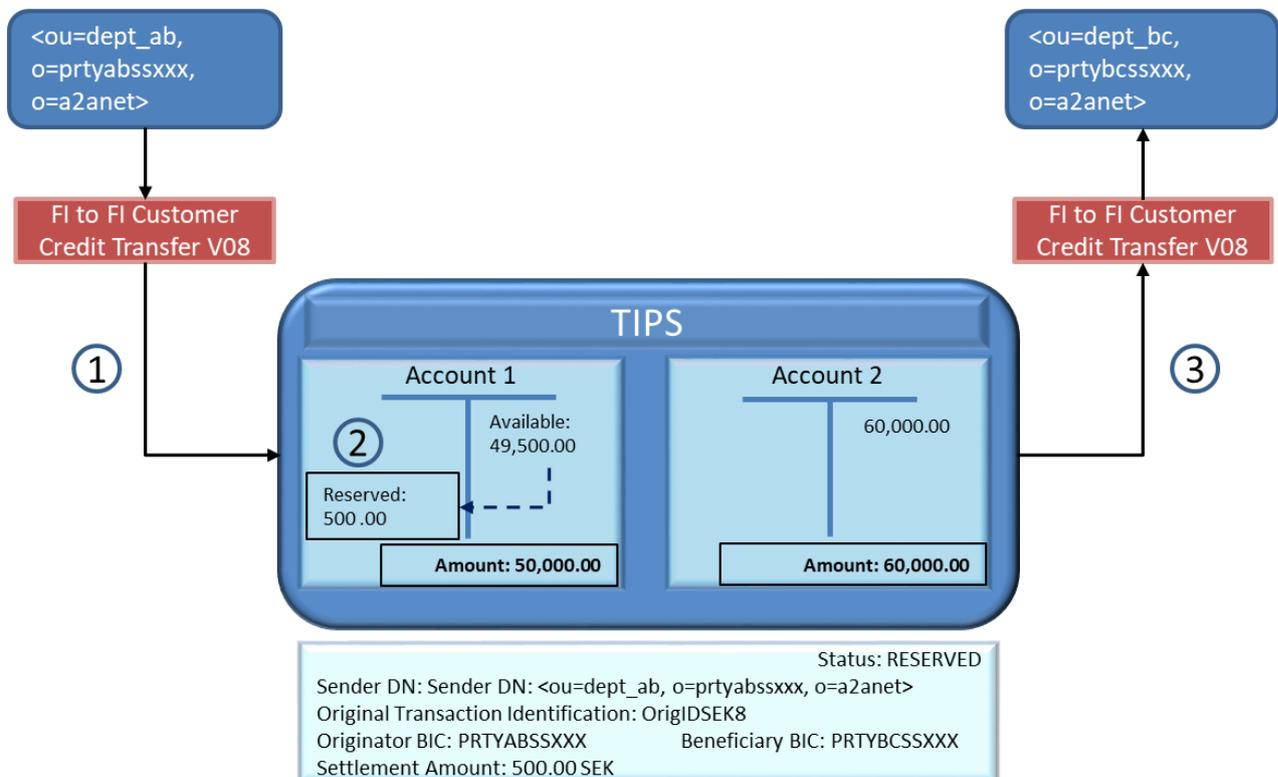

The answer from the Beneficiary side is delayed and does not reach TIPS in time to close the transaction. After a configured timeout, the Sweeper checks for pending payments. In case a pending payment is found for which the Timestamp Timeout has elapsed, TIPS triggers a timeout, rejects the transaction, un-reserves the funds on the debtor account as follows:

- It identifies the Originator Account (ACCOUNT1) from the retrieved transaction;
- It un-reserves the amount on the ACCOUNT1;
- The transaction status is turned into *Expired*;
- It identifies the Originator DN from the transaction;

- It identifies the Beneficiary DN from the transaction.

Figure 92 – Delayed Beneficiary-side answer: release of funds

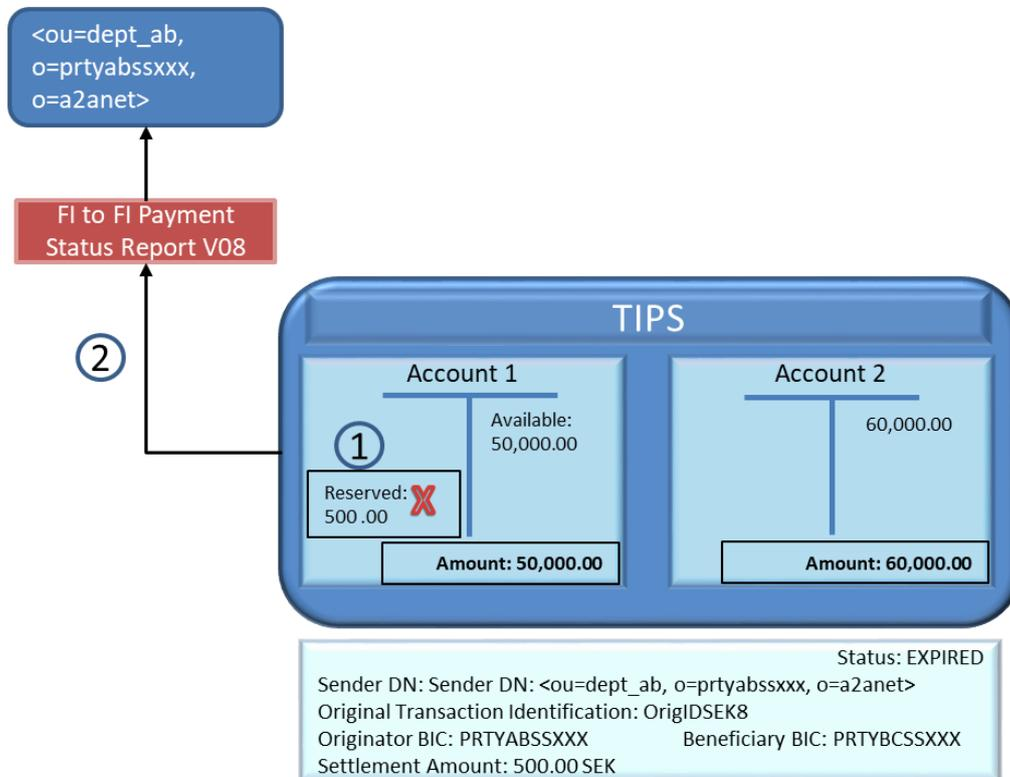

TIPS then sends a [FIToFIPaymentStatusReport \(pacs.002.001.10\)](#) to both the Originator and the Beneficiary Participants with the proper error code (see respectively [Figure 93](#) for Originator side and [Figure 94](#) for Beneficiary side).

Figure 93 – Timeout answer: FItoFIPaymentStatusReport (Originator side)

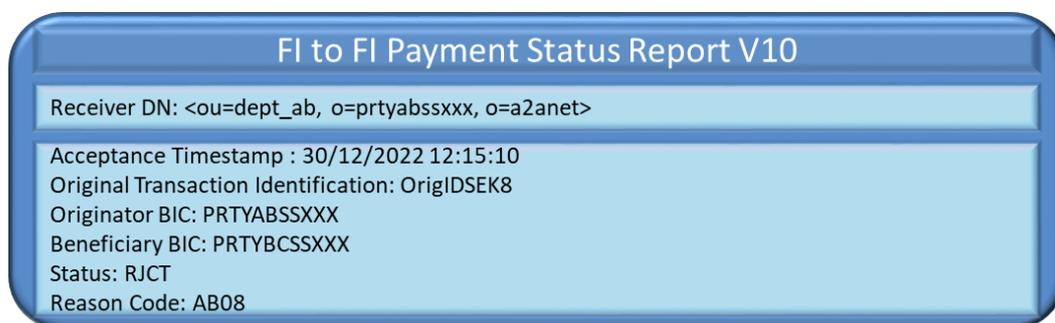

Figure 94 – Timeout answer: FltoFIPaymentStatusReport (Beneficiary side)

| FI to FI Payment Status Report V10 |
|--|
| Receiver DN: <ou=dept_bc, o=prtybcssxxx, o=a2anet> |
| Acceptance Timestamp : 30/12/2022 12:15:10 |
| Original Transaction Identification: OrigIDSEK8 |
| Originator BIC: PRTYABSSXXX |
| Beneficiary BIC: PRTYBCSSXXX |
| Status: RJCT |
| Reason Code: TM01 |

This example scenario foresees that Beneficiary-side reply reaches TIPS after the rejection due to timeout and un-reservation of funds of the relevant pending transaction. The delayed reply message generated by the Beneficiary Participant is the following.

Figure 95 – Delayed Beneficiary-side response: FltoFIPaymentStatusReport

| FI to FI Payment Status Report V10 |
|--|
| Sender DN: <ou=dept_bc, o=prtybcssxxx, o=a2anet> |
| Acceptance Timestamp : 30/12/2022 12:15:10 |
| Original Transaction Identification: OrigIDSEK8 |
| Originator BIC: PRTYABSSXXX |
| Beneficiary BIC: PRTYBCSSXXX |
| Status: ACCP |

TIPS rejects the message since the underlying transaction has been already rejected by the Sweeper and it is no longer in status pending.

Therefore, TIPS sends FI to FI Status Report to the same DN that sent the Beneficiary reply. The Original Transaction Identification inserted in the FI to FI Status Report is the one received in the Beneficiary reply.

Figure 96 – Delayed Beneficiary-side response: FltoFIPaymentStatusReport

| FI to FI Payment Status Report V10 |
|--|
| Receiver DN: <ou=dept_bc, o=prtybcssxxx, o=a2anet> |
| Acceptance Timestamp : 30/12/2022 12:15:10 |
| Original Transaction Identification: OrigIDSEK8 |
| Status: RJCT |
| Reason Code: AG09 |

2.2.3. Instant Payment (SIP settlement model)

This section focuses on the settlement of Instant Payment transactions adhering to the SIP settlement model, describing the full scenario and the related steps.

The introductory part of the section presents the general flow, including all the steps.

All the remaining sub-sections contain examples of the possible scenarios, starting from a successful one and detailing possible failure scenarios. Each example shows the relevant messages and how the main fields are filled.

The SIP settlement model covers the scenarios in which an Originator Participant or Instructing Party acting on behalf of the Originator Participant or a Reachable Party instructs TIPS in order to transfer funds to the account of a Beneficiary Participant without prior reservation of funds. The involved actors are:

- The Originator Participant, or Instructing Party acting on behalf of the Originator Participant or a Reachable Party, starting the scenario;
- The Beneficiary Participant, or Instructing Party acting on behalf of the Beneficiary Participant or a Reachable Party, receiving either the confirmation or the rejection of the payment.

The involved messages are:

- The [FIToFICustomerCreditTransfer](#) message sent by the Single Instructing Party acting on behalf of the counterparties in order to instruct the instant payment in a non-Euro currency;
- The [FIToFIPaymentStatusReport \(pacs.002.001.10\)](#) message sent by TIPS to inform the Single Instructing Party about the result of the settlement (i.e. settled, rejected, timed-out) in a non-Euro currency;
- The [FIToFICustomerCreditTransfer](#) message sent by the Single Instructing Party acting on behalf of the counterparties in order to instruct the instant payment in Euro currency;
- The [FIToFIPaymentStatusReport](#) message sent by TIPS to inform the Single Instructing Party actor about the result of the settlement (i.e. settled, rejected, timed-out) in Euro currency;
- The [ReturnAccount](#) message that is sent, on optional basis, by TIPS to the Single Instructing Party actor. The message is sent by TIPS if (i) the owner of the TIPS Account (or CMB) enables the floor and ceiling notifications and (ii) the configured threshold is crossed.

All the described scenarios are triggered under the assumption that the technical validation, check of mandatory fields and authentication of the user have already been successfully performed by ESMIG.

Similarly to the SCT^{Inst} processing, it is worth nothing that when the Debtor or Creditor BIC contains a BIC8 instead of a BIC11, the message is accepted and the BIC8 is translated into a BIC11 by appending "XXX" at the end of the BIC8 for further processing. All the steps are described considering BIC11 only.

Below is the diagram describing the process and the involved actors. The details of the steps are described in the following [Table 60 – Instant Payment transaction steps for SIP settlement](#) model.

Figure 97 – Instant Payment transaction flow for SIP settlement model

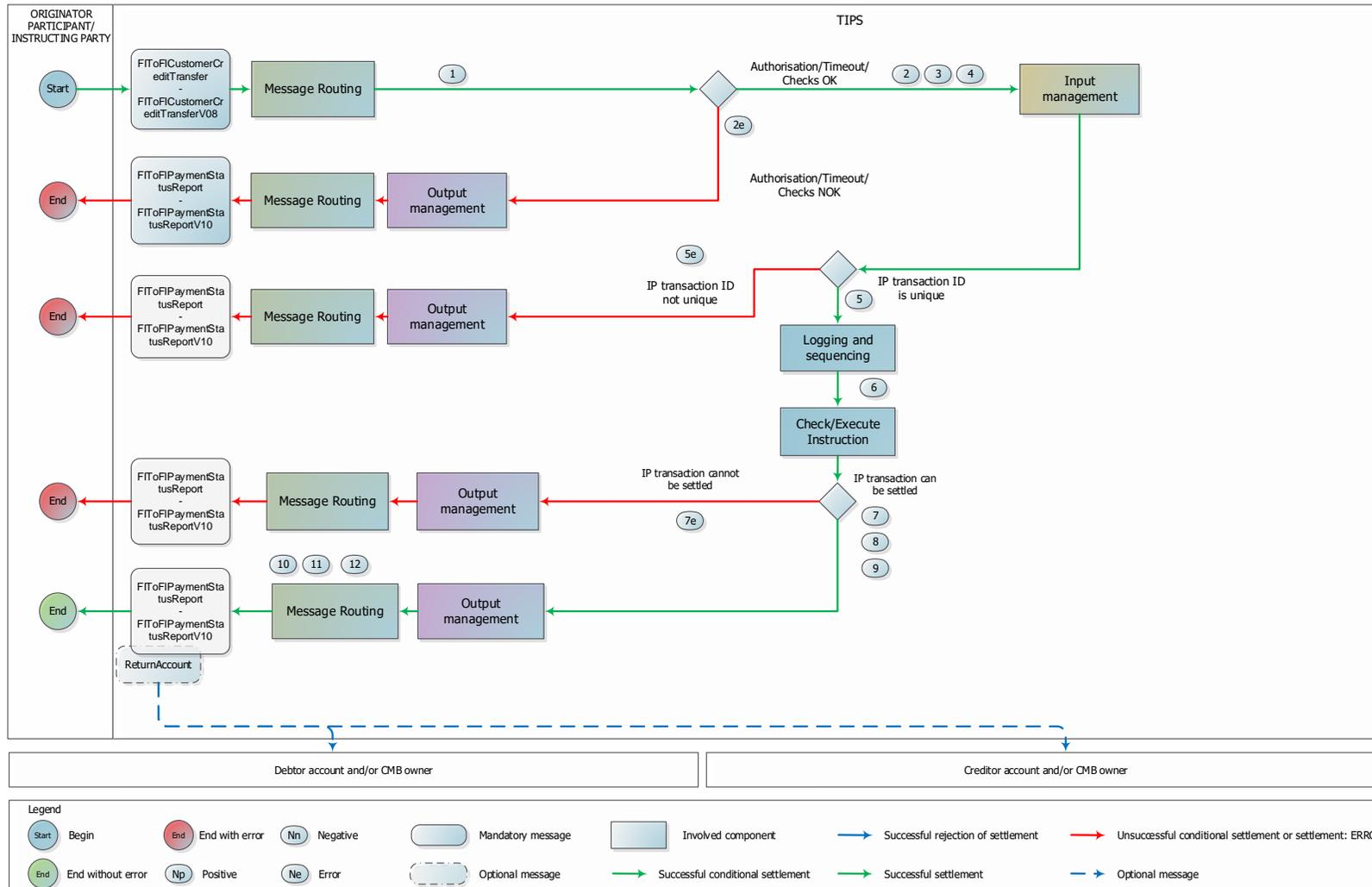

Table 60 – Instant Payment transaction steps for SIP settlement model

| Step | Involved messages | Involved actors | Description |
|------|--|---|---|
| 1 | FltoFICustomerCreditTransfer (instant payment in Euro currency) FIToFICustomerCreditTransfer (instant payment in a non-Euro currency) | Originator Participant, Ancillary System or Instructing Party as Sender TIPS as receiver | <p>TIPS receives an Instant Payment transaction from the Originator Participant, Ancillary System or Instructing Party acting on behalf of the Originator Participant or a Reachable Party.</p> <p>Technical validation, check of mandatory fields and authentication checks have already been successfully executed. The timeout for the Instant Payment transaction has not expired.</p> <p>TIPS logs the instruction as “Received”.</p> <p>TIPS verifies whether the DN of the Sender matches the DN of the beneficiary. The latter is identified in the "Outbound DN-BIC Routing" mapping table from the field Creditor Agent.</p> <p>If the check is successful, the Instant Payment will be settled following the SIP settlement model. If not, TIPS verifies whether the sender of the instant Payment is granted with the privilege ‘Instruct Instant Payment’.</p> <p>If the check is successful the Instant Payment will be settled following the standard settlement model which is described in Table 56 and Table 58, respectively for euro and non-euro currencies, otherwise the Instant Payment will be rejected due to lack of sufficient authorisation.</p> |
| 2 | | TIPS | <p>TIPS successfully executes the checks:</p> <ul style="list-style-type: none"> - Access Rights check; - Timeout Check - Originator Side; - Maximum Amount not Exceeded; - Originator Account or CMB existence; - Instructing Party authorised; - Beneficiary correctly configured; - Beneficiary Account or CMB existence. <p>As part of the authorisation checks, TIPS verifies whether the sender of the Instant Payment is granted with the privilege “Instruct as SIP”.</p> <p>If the check is successful, the Instant Payment will be settled following the SIP settlement model. If not, TIPS verifies whether the sender of the instant Payment is granted with the privilege ‘Instruct Instant Payment’.</p> <p>If the check is successful the Instant Payment will be settled following the standard settlement model which is described in Table 56 and Table 58, respectively for euro and</p> |

| Step | Involved messages | Involved actors | Description |
|------|---|--|--|
| | | | <p>non-euro currencies, otherwise the Instant Payment will be rejected to lack of sufficient authorisation.</p> <p>See 4.1- Business Rules for details.</p> |
| 2e | <p>FIToFIPaymentStatusReport (instant payment in Euro currency)</p> <p>FIToFIPaymentStatusReport (pacs.002.001.10) (instant payment in a non-Euro currency)</p> | <p>TIPS as sender</p> <p>Originator Participant, Ancillary System or Instructing Party as receiver</p> | <p>TIPS unsuccessfully executes one of the checks listed in step 2. At the first negative check the system stops and sends a message to the Originator Participant, Ancillary System or Instructing Party acting on behalf of the Originator Participant or a Reachable Party – same DN of the Sender in step 1 – containing the proper error code.</p> <p>If the failed check is "Timeout Check - Originator Side", the status of the transaction is set to "<i>Expired</i>"; in all the other cases, the status is set to "<i>Failed</i>".</p> |
| 3 | | TIPS | <p>TIPS infers the account to be debited from the configured accounts information, the Originator Participant BIC and the currency of the Instant Payment transaction.</p> <p>In details TIPS checks that:</p> <ul style="list-style-type: none"> (i) an account, with either type "TIPS Account" or "TIPS AS Technical Account", exists, (ii) it is linked to the Originator Participant (field "Originator BIC") as authorised user, (iii) and it is denominated in the same currency as the one defined in the Settlement Amount. <p>- If the check does not return any account, TIPS looks for a CMB linked to the Originator Participant (field "Originator BIC") as authorised user; - TIPS selects the account linked to the CMB; the account related to the CMB must be denominated in the same currency as the one defined in the Settlement Amount.</p> <p>From now on, the selected account is referred to as "Originator Account" and the possible CMB as "Debiting CMB".</p> |

| Step | Involved messages | Involved actors | Description |
|------|---|--|---|
| 4 | | TIPS | <p>TIPS infers the account to be credited from the configured accounts information, the Beneficiary Participant BIC and the currency of the Instant Payment transaction.</p> <p>In details TIPS checks that:</p> <ul style="list-style-type: none"> (i) an account, with either type "TIPS Account" or "TIPS AS Technical Account", exists, (ii) it is linked to the Beneficiary Participant (field "Beneficiary BIC") as authorised user, (iii) and has a currency equal to the one defined in the Settlement Amount. <p>- If the check does not return any account, TIPS looks for a CMB linked to the Beneficiary Participant (field "Beneficiary BIC") as authorised user; - TIPS selects the account linked to the CMB; the account related to the CMB must be denominated in the same currency as the one defined in the Settlement Amount.</p> <p>From now on, the selected account is referred to as "Beneficiary Account" and the possible CMB as "Crediting CMB".</p> |
| 5 | | TIPS | <p>TIPS successfully executes the check:</p> <ul style="list-style-type: none"> - Duplicate check; <p>See 4.1 - Business Rules for details.</p> |
| 5e | <p>FIToFIPaymentStatusReport (instant payment in Euro currency)</p> <p>FIToFIPaymentStatusReport (pacs.002.001.10) (instant payment in a non-Euro currency)</p> | <p>TIPS as sender</p> <p>Originator Participant, Ancillary System or Instructing Party as receiver</p> | <p>TIPS unsuccessfully executes the check listed in step 5.</p> <p>If the check is unsuccessful the system stops and sends a message to the Originator Participant, Ancillary System or Instructing Party acting on behalf of the Originator Participant or a Reachable Party – same DN of the Sender – containing the proper error code.</p> <p>The transaction is set to "Failed" status.</p> <p>See 4.1 - Business Rules for details.</p> |
| 6 | | TIPS | <p>TIPS sends it to the Check and Execute Instruction process. TIPS sets the transaction status to "Validated".</p> |

| Step | Involved messages | Involved actors | Description |
|------|---|--|---|
| 7 | | TIPS | <p>TIPS successfully executes the checks:</p> <ul style="list-style-type: none"> - Originator Account/CMB not blocked; - Beneficiary Account/CMB not blocked; - Available amount not exceeded; <p>See 4.1 - Business Rules for details.</p> |
| 7e | <p>FIToFIPaymentStatusReport (instant payment in Euro currency)</p> <p>FIToFIPaymentStatusReport (pacs.002.001.10) (instant payment in a non-Euro currency)</p> | <p>TIPS as sender</p> <p>Originator Participant, Ancillary System or Instructing Party as receiver</p> | <p>TIPS unsuccessfully executes the checks listed in step 7.</p> <p>At the first negative check the system stops and sends a message to the Originator Participant, Ancillary System or Instructing Party acting on behalf of the Originator Participant or a Reachable Party – same DN of the Sender in step 1 – containing the proper error code.</p> <p>The transaction is set to "<i>Failed</i>" status.</p> <p>See 4.1 - Business Rules for details.</p> |
| 8 | | TIPS | <p>The DN of the Sender in step 1 is saved as information related to the transaction. From now on, this DN is referred to as "Originator DN".</p> |
| 9 | | TIPS | <p>The full amount is settled and the transaction is set to "<i>Settled</i>" status.</p> <p>The available balance of the Originator Account is decreased by the amount of the corresponding settled transaction. If a Debiting CMB is involved, the system decreases its headroom by the same amount.</p> <p>The same positive amount is added to the Beneficiary Account. If a Crediting CMB is involved, TIPS increases its headroom by the same amount.</p> |
| 10 | <p>FIToFIPaymentStatusReport (instant payment in Euro currency)</p> <p>FIToFIPaymentStatusReport (pacs.002.001.10) (instant payment in a non-Euro currency)</p> | <p>TIPS as sender</p> <p>Originator Participant, Ancillary System or Instructing Party as receiver</p> | <p>TIPS generates a positive Payment status report and sends it to the Originator DN. The Payment status report contains the Transaction ID and Originator BIC of the transaction.</p> |

| Step | Involved messages | Involved actors | Description |
|------|-------------------------------|---|---|
| 11 | ReturnAccount | TIPS as sender Debited Account and/or CMB Owner | TIPS checks the "Floor notification amount" configured for the involved Originator account or Debiting CMB. After settlement confirmation, if the account balance and/or the CMB headroom crosses the threshold configured as "floor notification amount", TIPS sends a ReturnAccount to the Account and/or CMB owners involved in the transaction. The message is sent to the default DN of the Account Owner and/or CMB Owner. The message contains the Originator account number or the Debiting CMB number |
| 12 | ReturnAccount | TIPS as sender Credited Account and/or CMB Owner | TIPS checks the "Ceiling notification amount" configured for the involved Beneficiary account or Crediting CMB. After settlement confirmation, if the account balance and/or the CMB headroom crosses the threshold configured as "ceiling notification amount", TIPS sends a ReturnAccount to the Account and/or CMB owners involved in the transaction. The message is sent to the default DN of the Account Owner and/or CMB Owner. The message contains the Beneficiary account number or the Crediting CMB number |

2.2.3.1. Examples

This sub-section includes a not exhaustive list of examples of TIPS transactions for the SIP settlement model - without preliminary reservation of funds - and related messages.

Each example is introduced by a description of the involved actors and involved messages and it highlights how the balances change in the accounts.

All the examples are based on the data constellation introduced below. The data constellation is depicted on the basis of the concepts introduced in [1.3.2 "Accounts structure and organisation"](#).

Figure 98 – Instant Payment transaction in Euro - SIP model - examples data constellation

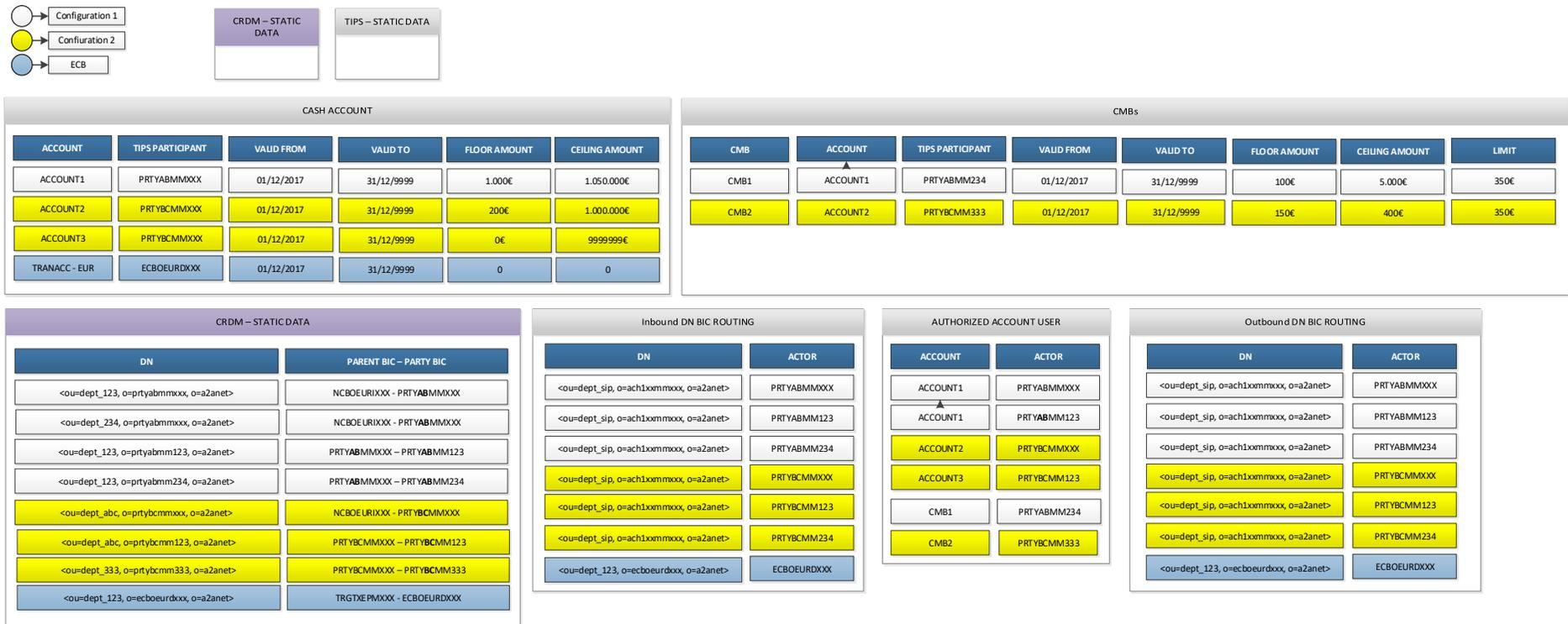
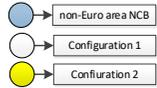

Figure 99 – Instant Payment transaction in a non-Euro currency - SIP settlement model - examples data constellation



| CRDM – STATIC DATA | TIPS – STATIC DATA |
|--------------------|--------------------|
| | |

| CASH ACCOUNT | | | | | |
|---------------|------------------|------------|------------|--------------|----------------|
| ACCOUNT | TIPS PARTICIPANT | VALID FROM | VALID TO | FLOOR AMOUNT | CEILING AMOUNT |
| ACCOUNT1 | PRTYABSSXXX | 23/05/2022 | 31/12/9999 | 50.000 SEK | 50.000.000 SEK |
| ACCOUNT2 | PRTYBCSSXXX | 23/05/2022 | 31/12/9999 | 30.000 SEK | 70.000.000 SEK |
| ACCOUNT3 | PRTYBCSSXXX | 23/05/2022 | 31/12/9999 | 10.000 SEK | 60.000.000 SEK |
| TRANACC - SEK | NCBOSEK0XXX | 23/05/2022 | 31/12/9999 | | |

| CMBs | | | | | | | |
|------|----------|------------------|------------|------------|--------------|----------------|------------|
| CMB | ACCOUNT | TIPS PARTICIPANT | VALID FROM | VALID TO | FLOOR AMOUNT | CEILING AMOUNT | LIMIT |
| CMB1 | ACCOUNT1 | PRTYABSSXXX | 23/05/2022 | 31/12/9999 | 10.000 SEK | 40.000 SEK | 50.000 SEK |
| CMB2 | ACCOUNT2 | PRTYBCSSXXX | 23/05/2022 | 31/12/9999 | 5.000 SEK | 20.000 SEK | 25.000 SEK |

| CRDM – STATIC DATA | |
|--|---------------------------|
| DN | PARENT BIC – PARTY BIC |
| <ou=dept_ab, o=prtyabsxxx, o=a2anet> | NCBOSEK0XXX - PRTYABSSXXX |
| <ou=dept_ab, o=prtyabs123, o=a2anet> | NCBOSEK0XXX - PRTYABSS123 |
| <ou=dept_ab, o=prtyabs234, o=a2anet> | NCBOSEK0XXX - PRTYABSS234 |
| <ou=dept_bc, o=prtybcssxxx, o=a2anet> | NCBOSEK0XXX - PRTYBCSSXXX |
| <ou=dept_bc, o=prtybcss123, o=a2anet> | NCBOSEK0XXX - PRTYBCSS123 |
| <ou=dept_bc, o=prtybcss234, o=a2anet> | NCBOSEK0XXX - PRTYBCSS234 |
| <ou=dept_ncb, o=ncbosek0xxx, o=a2anet> | TRGTXP0000 - NCBOSEK0XXX |

| Inbound DN BIC ROUTING | |
|--|-------------|
| DN | ACTOR |
| <ou=dept_slp, o=ach1xxxxxxx, o=a2anet> | PRTYABSSXXX |
| <ou=dept_slp, o=ach1xxxxxxx, o=a2anet> | PRTYABSS123 |
| <ou=dept_slp, o=ach1xxxxxxx, o=a2anet> | PRTYABSS234 |
| <ou=dept_slp, o=ach1xxxxxxx, o=a2anet> | PRTYBCSSXXX |
| <ou=dept_slp, o=ach1xxxxxxx, o=a2anet> | PRTYBCSS123 |
| <ou=dept_slp, o=ach1xxxxxxx, o=a2anet> | PRTYBCSS234 |
| <ou=dept_ncb, o=ncbosek0xxx, o=a2anet> | NCBOSEK0XXX |

| AUTHORIZED ACCOUNT USER | |
|-------------------------|-------------|
| ACCOUNT | ACTOR |
| ACCOUNT1 | PRTYABSSXXX |
| ACCOUNT1 | PRTYABSS123 |
| CMB1 | PRTYABSS234 |
| ACCOUNT2 | PRTYBCSSXXX |
| ACCOUNT3 | PRTYBCSS123 |
| CMB2 | PRTYBCSS234 |

| Outbound DN BIC ROUTING | |
|--|-------------|
| DN | ACTOR |
| <ou=dept_slp, o=ach1xxxxxxx, o=a2anet> | PRTYABSSXXX |
| <ou=dept_slp, o=ach1xxxxxxx, o=a2anet> | PRTYABSS123 |
| <ou=dept_slp, o=ach1xxxxxxx, o=a2anet> | PRTYABSS234 |
| <ou=dept_slp, o=ach1xxxxxxx, o=a2anet> | PRTYBCSSXXX |
| <ou=dept_slp, o=ach1xxxxxxx, o=a2anet> | PRTYBCSS123 |
| <ou=dept_slp, o=ach1xxxxxxx, o=a2anet> | PRTYBCSS234 |
| <ou=dept_ncb, o=ncbosek0xxx, o=a2anet> | NCBOSEK0XXX |

2.2.3.1.1 Successful scenario – Euro currency – only accounts involved

This positive scenario describes a successful payment transaction between two TIPS Accounts owned and held by two TIPS Participants. The same entity acts on behalf as Instructing Party for both TIPS Participants. “Configuration 1” and “Configuration 2” (highlighted in white and yellow in [Figure 98 – Instant Payment transaction in Euro - SIP model - examples data constellation](#)) are considered.

No errors or timeouts occur. No floor or ceiling notification expected. The current business date, in the given example, is 30/12/2022. The [FltoFICustomerCreditTransfer](#) message received by TIPS and triggering the scenario looks like the following one.

**Figure 100 – Successful Instant Payment in Euro with SIP model:
FltoFICustomerCreditTransfer**



Received the message, TIPS proceeds as follow:

- It identifies the Beneficiary DN from the “Outbound DN-BIC Routing” (<ou=dept_sip, o=ach1xxmmxxx, o=a2anet>);
- It checks that the Beneficiary DN matches the Sender DN (<ou=dept_sip, o=ach1xxmmxxx, o=a2anet>).

The system, after performing the expected checks successfully, executes the settlement on the accounts as follows:

- It identifies the Originator Account (ACCOUNT1) from the Originator BIC;
- It identifies the Beneficiary Account (ACCOUNT2) from the Beneficiary BIC;
- It definitively settles the amount moving the Settlement Amount from ACCOUNT1 to ACCOUNT2;
- The transaction status is turned into *Settled*.

Figure 101 – Successful Instant Payment in Euro with SIP model: settlement phase

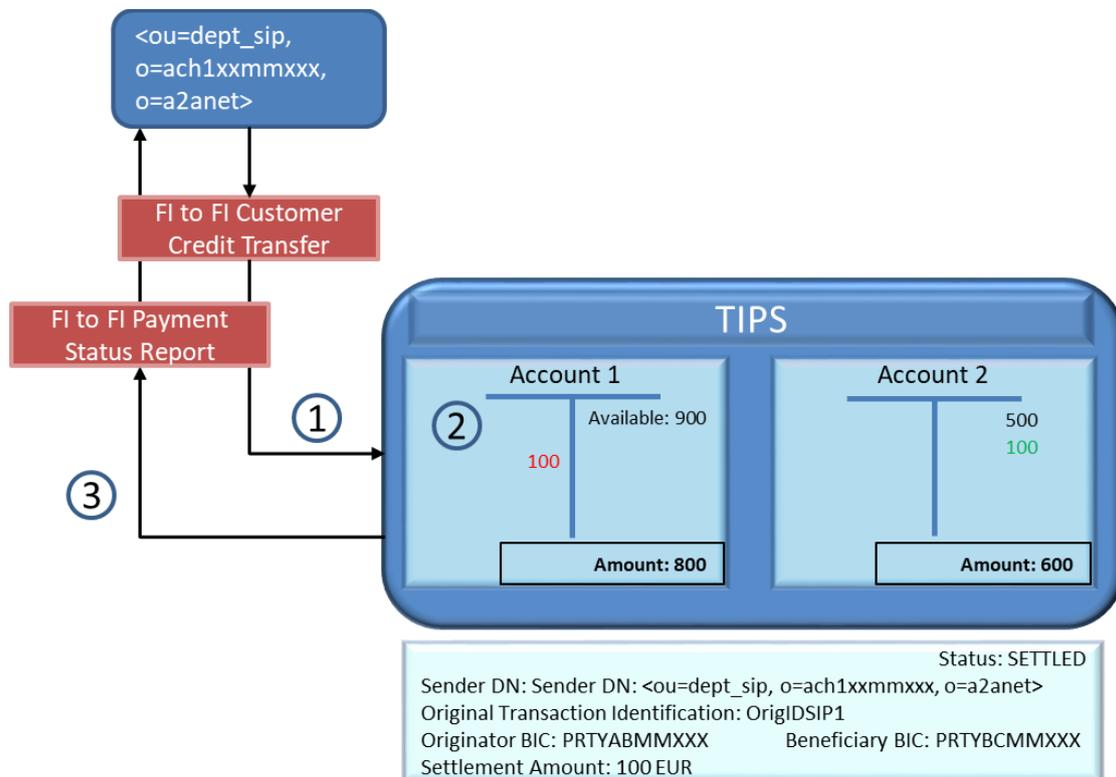

TIPS then sends the [FIToFIPaymentStatusReport](#) message to confirm the successful settlement to the Originator DN.

Figure 102 – Successful Instant Payment in Euro with SIP model: FItoFIPaymentStatusReport

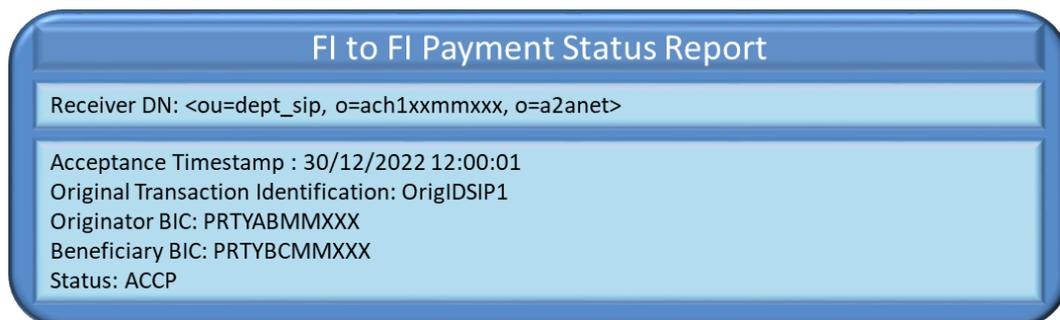

2.2.3.1.2 Successful scenario – Euro currency – Creditor account and debtor CMB

This positive scenario describes a successful payment transaction between a CMB held by a branch of a TIPS Participant B and a TIPS Account owned and held by a TIPS Participant A. The same entity acts on behalf as Instructing Party for both the branch of TIPS Participant B and the TIPS Participant A. “Configuration 1” and “Configuration 2” (highlighted in white and yellow in [Figure 98 – Instant Payment transaction in Euro - SIP model - examples data constellation](#)) are considered.

No errors or timeouts occur. No floor or ceiling notification expected. The current business date, in the given example, is 30/12/2022. The [FltoFICustomerCreditTransfer](#) message received by TIPS and triggering the scenario looks like the following one.

**Figure 103 – Successful Instant Payment in non-Euro currency with SIP:
FltoFICustomerCreditTransfer**

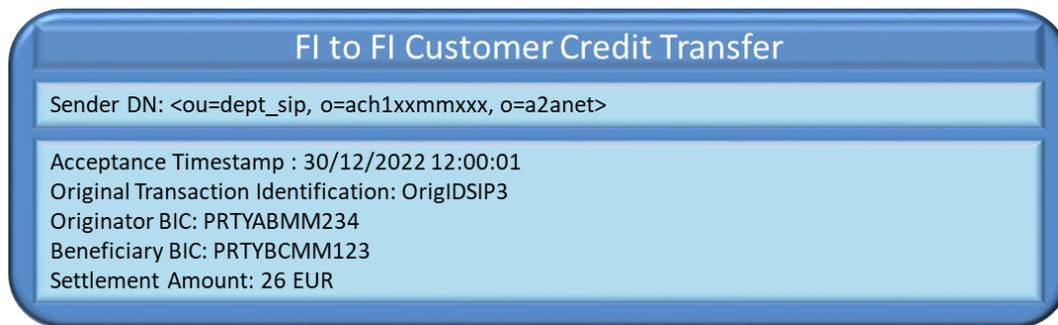

Received the message, TIPS proceeds as follow:

- It identifies the Beneficiary DN from the “Outbound DN-BIC Routing” (<ou=dept_sip, o=ach1xxssxxx, o=a2anet>);
- It checks that the Beneficiary DN matches the Sender DN (<ou=dept_sip, o=ach1xxssxxx, o=a2anet>).

The system, after performing the expected checks successfully, executes the settlement on the accounts as follows:

- It identifies the Originator Account (ACCOUNT1) from the Originator BIC;
- It identifies the Crediting CMB (CMB2) from the Beneficiary BIC;
- It identifies the Beneficiary Account (ACCOUNT2) from the CMB2 in table CMBs;
- It definitively settles the amount moving the Settlement Amount from ACCOUNT1 to ACCOUNT2;
- It increases the headroom of the CMB2;
- The transaction status is turned into *Settled*.

Figure 104 – Successful Instant Payment in non-Euro currency with SIP: settlement phase

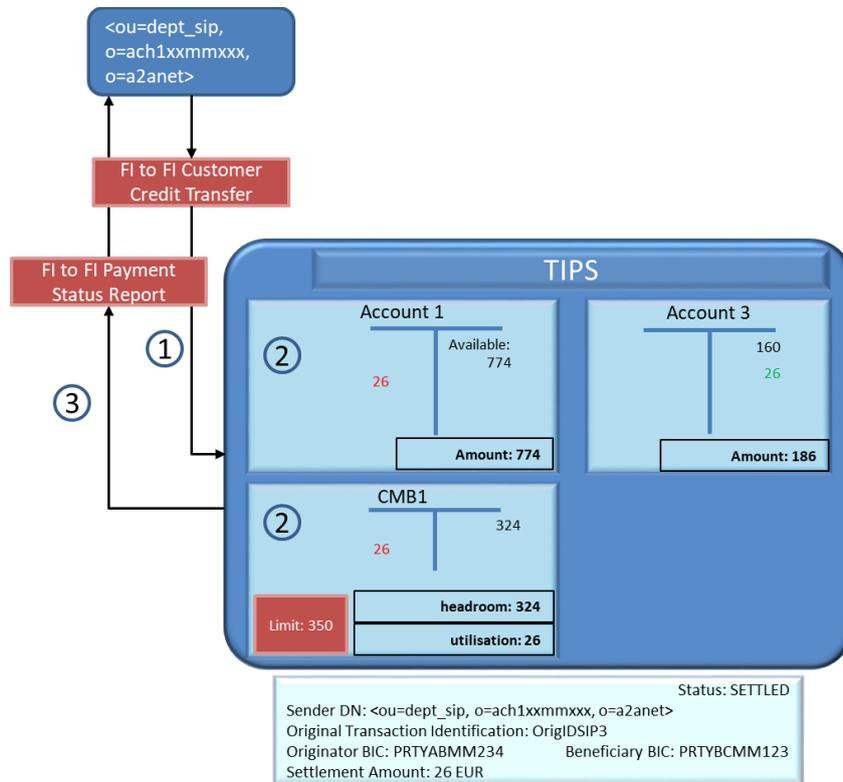

TIPS then sends the [FIToFIPaymentStatusReport](#) message to confirm the successful settlement to the Originator DN.

Figure 105 – Successful Instant Payment in non-Euro currency with SIP: FItoFIPaymentStatusReport



2.2.3.1.3 Successful scenario – non-Euro currency – only accounts involved

This positive scenario describes a successful payment transaction between two TIPS Accounts owned and held by two TIPS Participants. The same entity acts on behalf as Instructing Party for both TIPS Participants. “Configuration 1” and “Configuration 2” (highlighted in white and yellow in [Figure 99 – Instant Payment transaction in a non-Euro currency - SIP settlement model - examples data](#)) are considered.

No errors or timeouts occur. No floor or ceiling notification expected. The current business date, in the given example, is 30/12/2022. The [FIToFICustomerCreditTransfer](#) message received by TIPS and triggering the scenario looks like the following one.

**Figure 106 – Successful Instant Payment in non-Euro currency with SIP:
FIToFICustomerCreditTransfer**

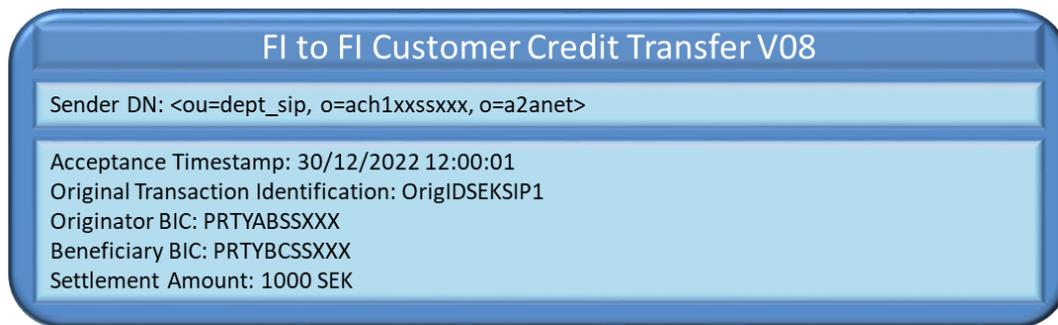

Received the message, TIPS proceeds as follow:

- It identifies the Beneficiary DN from the “Outbound DN-BIC Routing” (<ou=dept_sip, o=ach1xsssxxx, o=a2anet>);
- It checks that the Beneficiary DN matches the Sender DN (<ou=dept_sip, o=ach1xsssxxx, o=a2anet>).

The system, after performing the expected checks successfully, executes the settlement on the accounts as follows:

- It identifies the Originator Account (ACCOUNT1) from the Originator BIC;
- It identifies the Beneficiary Account (ACCOUNT2) from the Beneficiary BIC;
- It definitively settles the amount moving the Settlement Amount from ACCOUNT1 to ACCOUNT2;
- The transaction status is turned into *Settled*.

Figure 107 – Successful Instant Payment in non-Euro currency with SIP: settlement phase

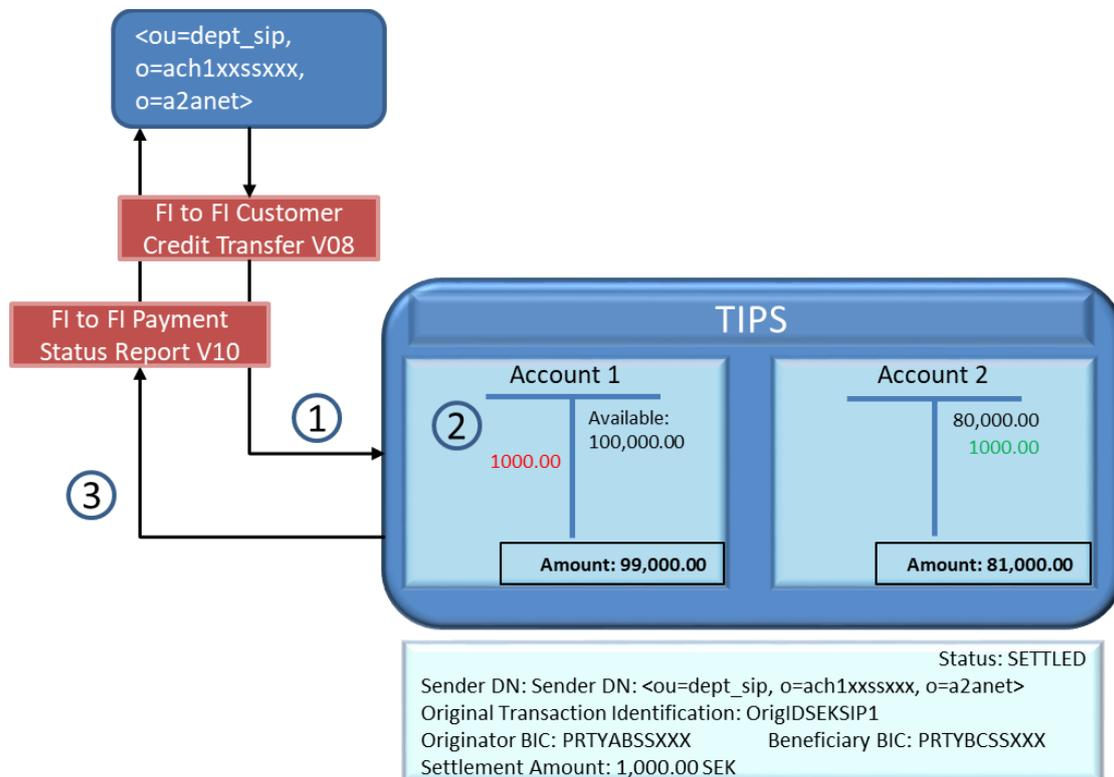

TIPS then sends the [FIToFIPaymentStatusReport \(pacs.002.001.10\)](#) message to confirm the successful settlement to the Originator DN.

Figure 108 – Successful Instant Payment in non-Euro currency with SIP: FItoFIPaymentStatusReport

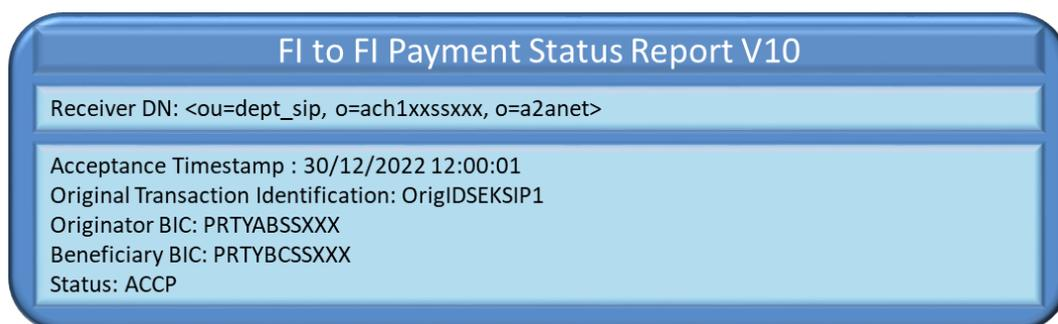

2.2.3.1.4 Successful scenario – non-Euro currency – Creditor CMB and debtor account

This positive scenario describes a successful payment transaction between a TIPS Account owned and held by a TIPS Participant A and a CMB held by a branch of a TIPS Participant B. The same entity acts on behalf as Instructing Party for both the TIPS Participant A and the branch of TIPS Participant B. “Configuration 1” and “Configuration 2” (highlighted in white and yellow in [Figure 99 – Instant Payment transaction in a non-Euro currency - SIP settlement model - examples data](#)) are considered.

No errors or timeouts occur. No floor or ceiling notification expected. The current business date, in the given example, is 30/12/2022. The [FIToFICustomerCreditTransfer](#) message received by TIPS and triggering the scenario looks like the following one.

**Figure 109 – Successful Instant Payment in non-Euro currency with SIP:
FIToFICustomerCreditTransfer**

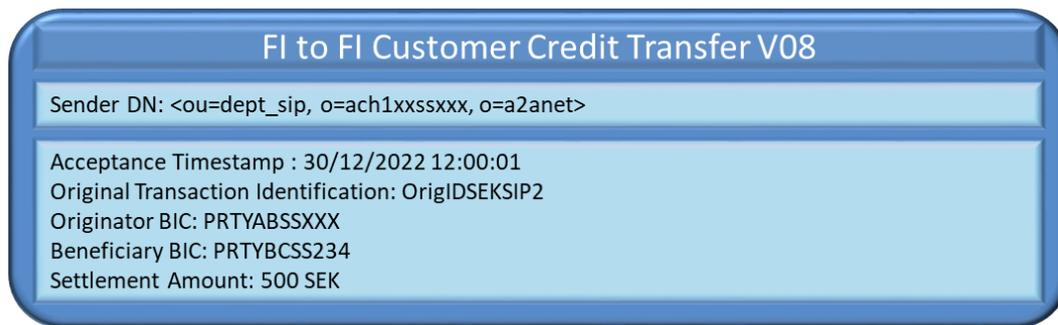

Received the message, TIPS proceeds as follow:

- It identifies the Beneficiary DN from the “Outbound DN-BIC Routing” (<ou=dept_sip, o=ach1xssxxx, o=a2anet>);
- It checks that the Beneficiary DN matches the Sender DN (<ou=dept_sip, o=ach1xssxxx, o=a2anet>).

The system, after performing the expected checks successfully, executes the settlement on the accounts as follows:

- It identifies the Originator Account (ACCOUNT1) from the Originator BIC;
- It identifies the Crediting CMB (CMB2) from the Beneficiary BIC;
- It identifies the Beneficiary Account (ACCOUNT2) from the CMB2 in table CMBs;
- It definitively settles the amount moving the Settlement Amount from ACCOUNT1 to ACCOUNT2;
- It increases the headroom of the CMB2;
- The transaction status is turned into *Settled*.

Figure 110 – Successful Instant Payment in non-Euro currency with SIP: settlement phase

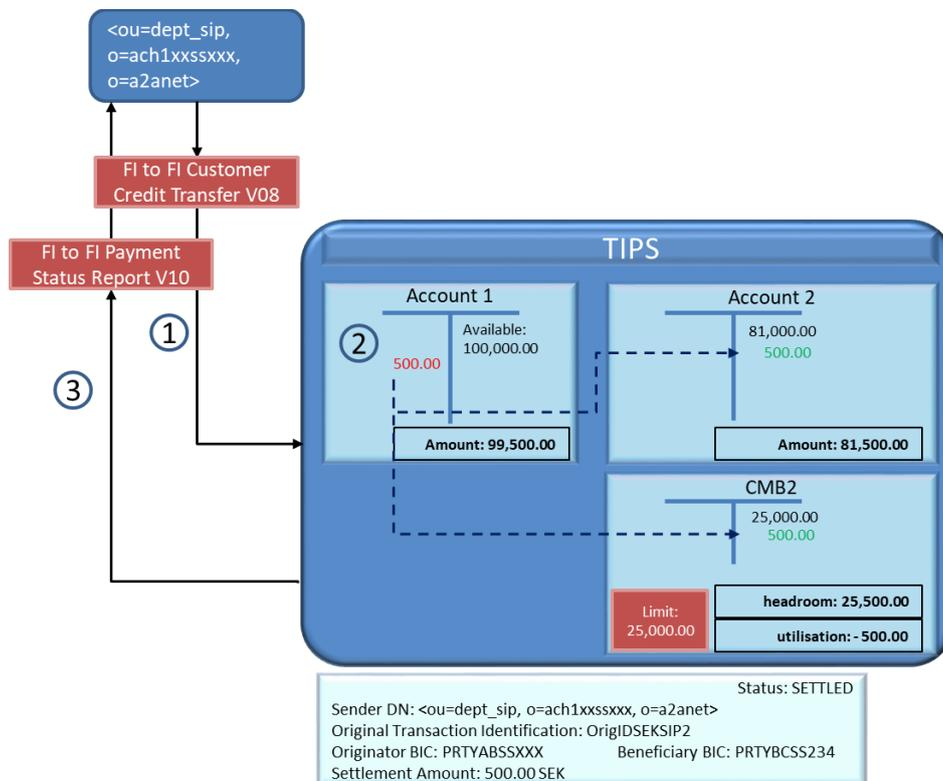

TIPS then sends the [FIToFIPaymentStatusReport \(pacs.002.001.10\)](#) message to confirm the successful settlement to the Originator DN.

Figure 111 – Successful Instant Payment in non-Euro currency with SIP: FIttoFIPaymentStatusReport

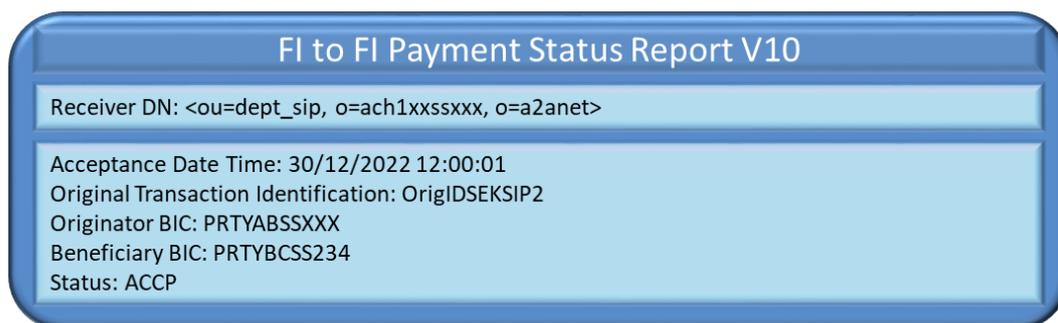

2.2.3.1.5 Error scenarios

This section describes some possible error scenarios that can happen when dealing with Instant Payment for the SIP settlement model. This is a subset of possible error cases but the error mechanism is always the same.

For the complete list of possible error codes, see [4.2 “List of Error codes”](#).

Insufficient funds within the CMB

This error scenario describes a payment transaction between a CMB held by a branch of a TIPS Participant A sending messages on its own and a TIPS Account owned by a TIPS Participant. “Configuration 1” and “Configuration 2” (highlighted in white and yellow in [Figure 98 – Instant Payment transaction in Euro - SIP model - examples data constellation](#)) are considered.

The transaction fails since the requested amount exceeds the headroom of the involved CMB.

The [FltoFICustomerCreditTransfer](#) message received by TIPS and triggering the scenario looks like the following one:

Figure 112 – Headroom error: FltoFICustomerCreditTransfer

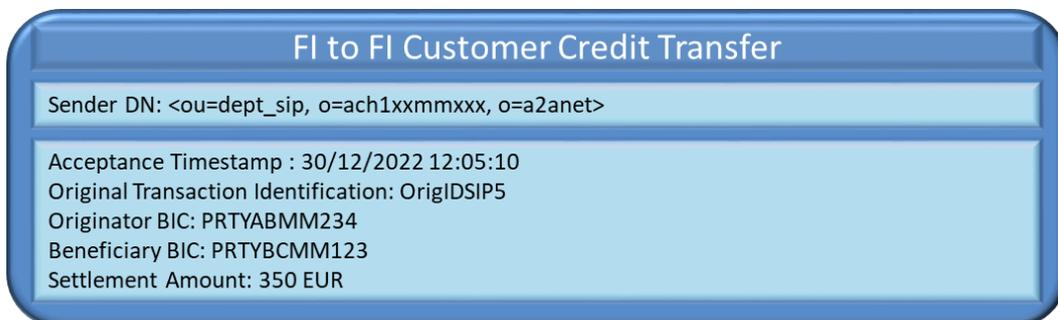

The system executes these steps:

- It identifies the Debiting CMB (CMB1) from the Originator BIC;
- It identifies that the headroom for the involved CMB1 is lower than the request amount;
- The transaction fails. The attempt is saved as failed transaction and the sender is informed of the error.

Figure 113 – Headroom error: transaction failed

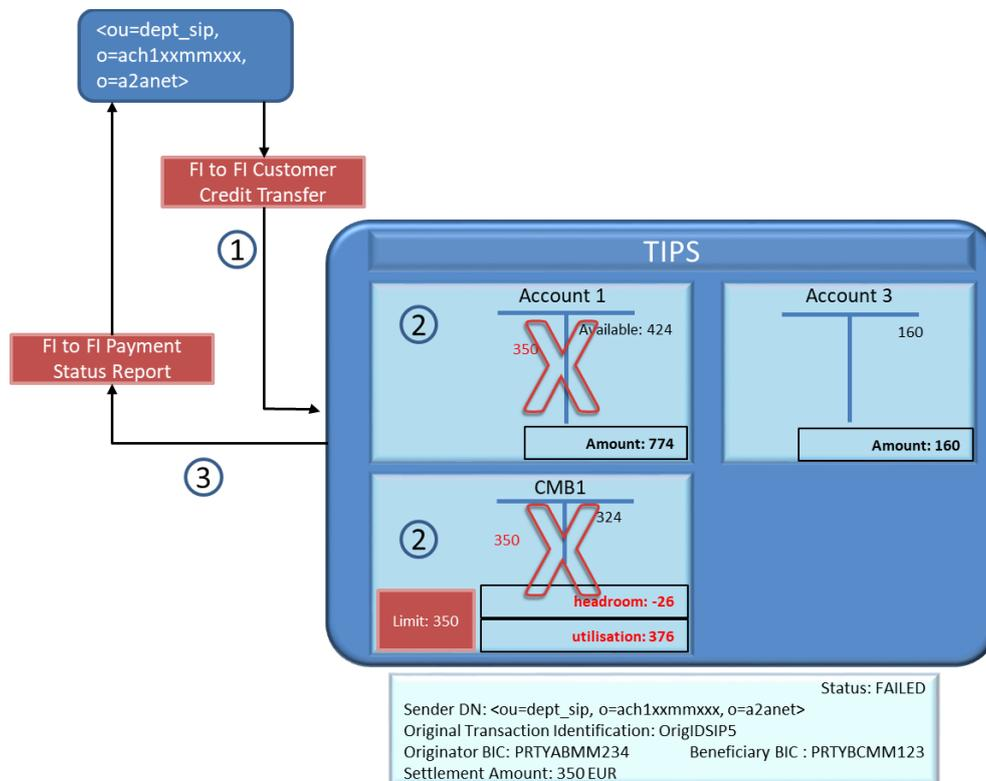

TIPS then sends a [FIToFIPaymentStatusReport](#) to the sender with the proper error code.

Figure 114 – Headroom error: FItoFIPaymentStatusReport

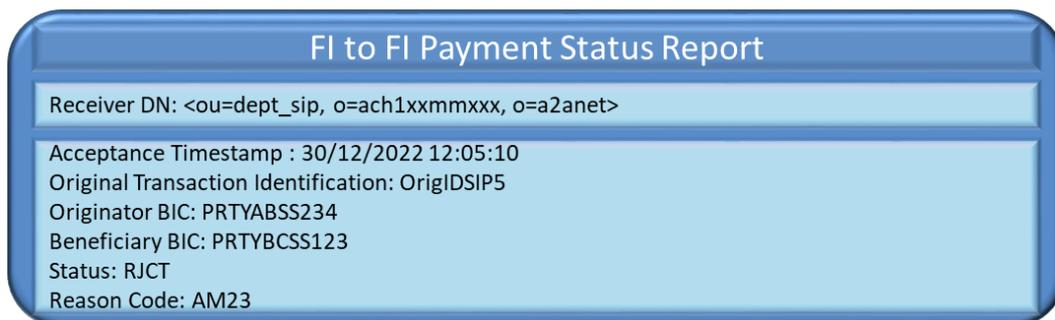

Blocked Account

This error scenario describes a payment transaction between two TIPS Accounts owned and held by two TIPS Participants making use of a Single Instructing Party to deliver messages to TIPS.

The transaction fails since the account to be debited is blocked and not available for settlement.

The [FIToFICustomerCreditTransfer](#) message received by TIPS and triggering the scenario looks like the following one.

Figure 115 – Blocked account error: FItoFICustomerCreditTransfer

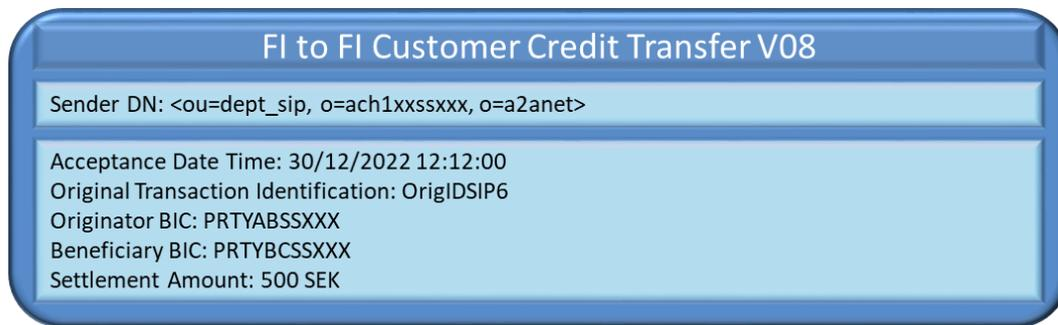

The system executes these steps:

- It identifies the Debiting Account (ACCOUNT1) from the Originator BIC;
- It detects that ACCOUNT1 is blocked (e.g. status is either 'blocked for debit' or 'blocked for credit and debit');
- The transaction fails. The attempt is saved as failed Instant Payment transaction and the sender is informed of the error.

Figure 116 – Blocked account error: transaction failed

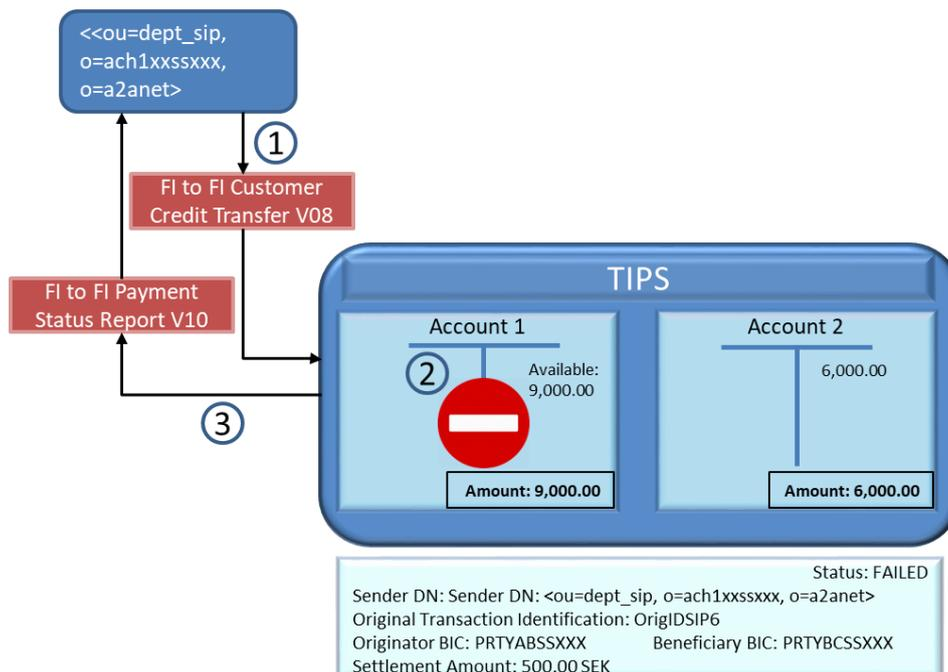

TIPS then sends a [FIToFIPaymentStatusReport \(pacs.002.001.10\)](#) to the Single Instructing Party that reports a specific error code.

Figure 117 – Blocked account error: FItoFIPaymentStatusReport

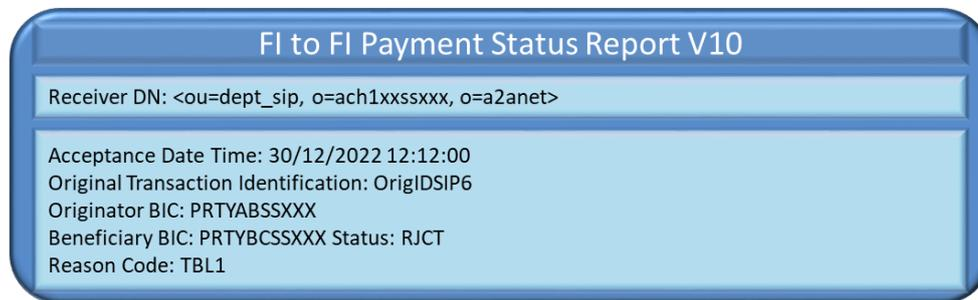

2.3. Recall

This section focuses on the processing of Recall requests and provides the description of the full scenario and the related steps. The same processing also applies in respect of Recall Requests for transactions denominated in a non-Euro currency³⁶.

A Recall request is forwarded by the Assigner which is an Originator Participant, Ancillary System or Instructing Party of a previously settled Instant Payment transaction to request that the given transaction is refunded and the amount – equal or possibly lower than the original one – is credited back to the original account. The request is forwarded by the Assigner to TIPS and passed directly by TIPS to the Assignee which is the relevant Beneficiary or a party acting on behalf of the Beneficiary Participant. The request could be either answered negatively or positively via a Recall Response message. If the Assignee rejects the recall, the negative response is immediately forwarded back to the Assigner of the Recall. If the Assignee sends a positive Recall Response, TIPS attempts to settle the returned amount. From a TIPS viewpoint, a Recall process is independent from the transaction it is attempting to recall; the involved actors are responsible for the agreement about the refund that is sent and processed in TIPS.

The involved actors are:

- The Recall Assigner: the Originator Participant, Ancillary System or Instructing Party of a previously settled instruction that sends the Recall request;
- The Recall Assignee: the Beneficiary Participant, Ancillary System or Instructing Party that receives the Recall request.

The involved messages for SCT^{Inst} scheme are:

- The [FIToFIPaymentCancellationRequest](#) message, used to request the cancellation of an original Instant Payment transaction and the return of funds previously settled.
- The [PaymentReturn](#) message, used to respond positively to the Recall request.
- The [ResolutionOfInvestigation](#) message, used to respond negatively to the Recall request.
- The [FIToFIPaymentStatusReport](#) message sent by TIPS in the following cases within the SCT^{Inst} scheme:

³⁶ For details regarding the messages involved in the process of a Recall Request related to a transaction denominated in a non-Euro currency, please refer to [Table 77 – List of messages for non-Euro schemes](#).

- To reject a Recall request or a Recall Response as they cannot be validated;
 - To notify to the Assignee the successful settlement of the Recall request as a result of the positive Recall answer.
- The [ReturnAccount](#) message can be possibly sent to Creditor Account Owner and/or Debtor Account Owner – if TIPS Actors have configured the floor and ceiling notification and if the related configured thresholds are reached.

If no response to a previously sent [FIToFIPaymentCancellationRequest](#) is received, the Recall Assigner can send a [FIToFIPaymentStatusRequest](#) message to TIPS to request a status update on a single Recall or on a set of Recall referred to the same Recall Assignee. The message, after successful validation, is forwarded by TIPS to the Beneficiary Participant (i.e. the Recall Assignee) for further processing. The answer to such message generated by the Recall Assignee is either a [PaymentReturn](#) (positive response) or a [ResolutionOfInvestigation](#) (negative response) for each Recall referenced in the FIToFIPaymentStatusRequest message.

The involved messages for non-euro currency scheme are:

- The [FIToFIPaymentCancellationRequest \(camt.056.001.08\)](#) message, used to request the cancellation of an original Instant Payment transaction and the return of funds previously settled.
- The [PaymentReturn \(pacs.004.001.09\)](#) message, used to respond positively to the Recall request.
- The [ResolutionOfInvestigation \(camt.029.001.09\)](#) message, used to respond negatively to the Recall request.
- The [FIToFIPaymentStatusReport \(pacs.002.001.10\)](#) message sent by TIPS in the following cases within non-Euro currencies scheme:
 - To reject a Recall request or a Recall Answer³⁷ as they cannot be validated;
 - To notify to the Assignee the successful settlement of the Recall request as a result of the positive Recall Answer.
- The [ReturnAccount](#) message can be possibly sent to Creditor Account Owner and/or Debtor Account Owner – if TIPS Actors have configured the floor and ceiling notification and if the related configured thresholds are reached.

The process described below is triggered under the assumption that the technical validation, check of mandatory fields and authentication of the user have already been successfully performed by ESMIG.

Besides it's important to keep in mind that when the Assigner or Assignee BIC contain a BIC8 instead of a BIC11, the message is accepted and the string is completed by appending "XXX" at the end of the BIC8 for further processing. All the steps are described considering BIC11 only.

[Figure 118 – Recall flow](#) shows the general flow for Recalls processing and contains message events and involved actors. The details of each step are provided in the following [Table 61 – Recall steps](#).

³⁷ It is worth noting that the 'Recall Answer' terminology is kept for the non-Euro currency schemes (and in the corresponding message descriptions in chapter 3). This term is fully equivalent to the 'Recall Response' term adopted in the context of EPC SCT-Inst scheme.

Figure 118 – Recall flow

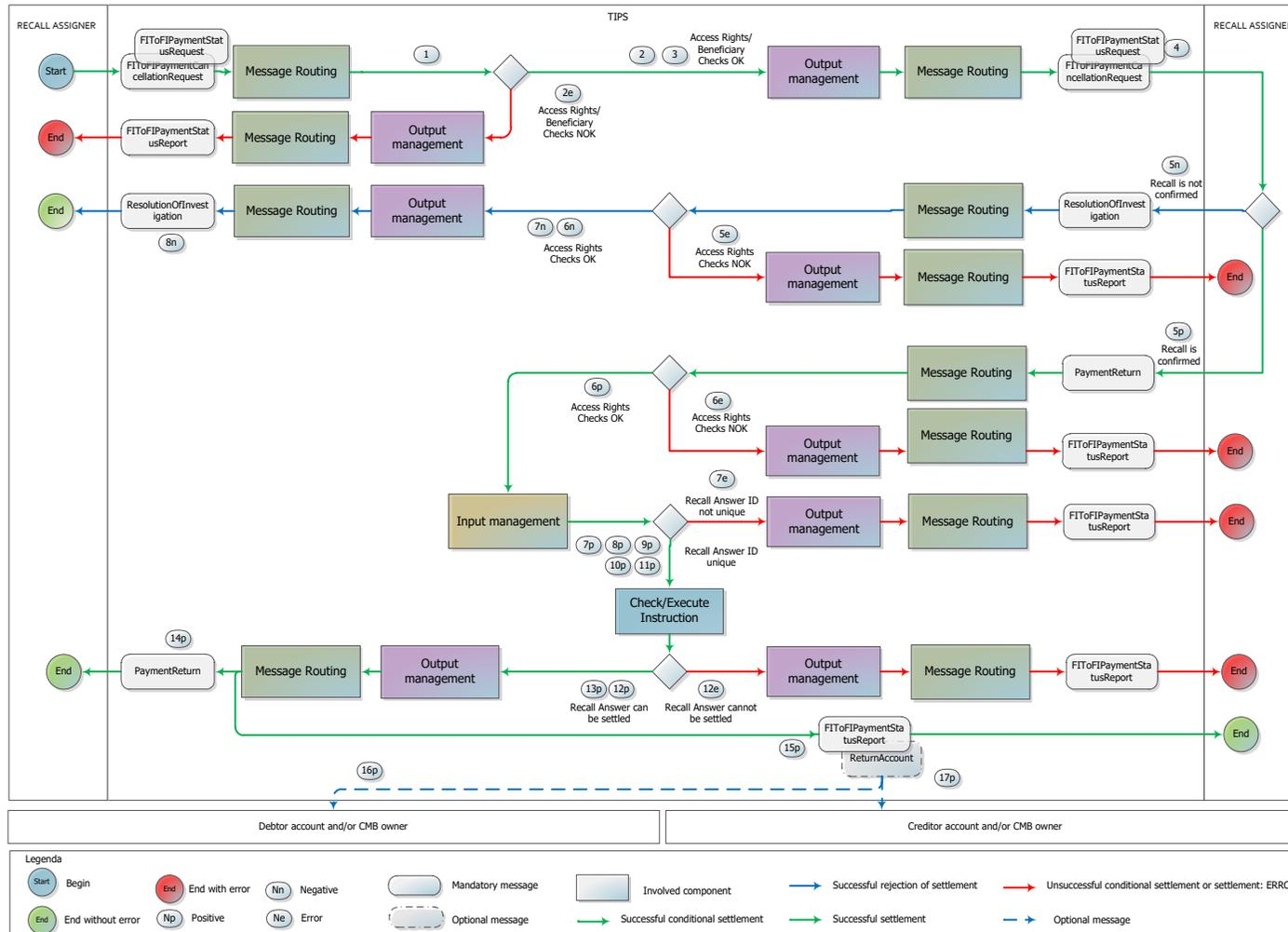

Table 61 – Recall steps

| Step | Involved messages | Involved actors | Description |
|------|--|---|--|
| 1 | FIToFIPaymentCancellationRequest FIToFIPaymentStatusRequest (Euro currency) or FIToFIPaymentCancellationRequest (camt.056.001.08) FIToFIPaymentStatusRequest (pacs.028.001.03) (non-Euro currency) | Recall Assigner as sender TIPS as receiver | TIPS receives an incoming Recall request (or a Request for Status Update on a Recall) from the Recall Assigner. Technical validation, check of mandatory fields and authentication checks have already been successfully executed by ESMIG. |
| 2 | | TIPS | TIPS successfully executes the following checks: - Access Rights check ; - Instructing Party authorised ; - Originator Account or CMB existence ; - Beneficiary correctly configured . See 4.1- Business Rules for details. |
| 2e | FIToFIPaymentStatusReport ³⁸ (Euro currency) or FIToFIPaymentStatusReport (pacs.002.001.10) ³⁹ (non-Euro currency) | TIPS as sender Recall Assigner as receiver | TIPS unsuccessfully executes one of the checks listed in step 2 . At the first negative check the system stops and sends a message to the Recall Assigner – same DN of the Sender in step 1 – containing the proper error code. |
| 3 | | TIPS | The DN of the Recall Assignee is identified in the "Outbound DN-BIC Routing" mapping table from the field Assignee (FIToFIPaymentCancellationRequest). |

³⁸ For SCT Inst scheme.

³⁹ For non-Euro currencies scheme.

| Step | Involved messages | Involved actors | Description |
|------|--|---|---|
| 4 | FIToFIPaymentCancellationRequest FIToFIPaymentStatusRequest (Euro currency) or FIToFIPaymentCancellationRequest (camt.056.001.08) FIToFIPaymentStatusRequest (pacs.028.001.03) (non-Euro currency) | TIPS as sender Recall Assignee as receiver | TIPS forwards the received Recall request (or a Request for Status Update on a Recall) to the Recall Assignee DN. |
| 5n | ResolutionOfInvestigation (Euro currency) or ResolutionOfInvestigation (camt.029.001.09) (non-Euro currency) | Recall Assignee as sender TIPS as receiver | The Recall Assignee sends a negative response and it is successfully delivered to TIPS. Technical validation, check of mandatory fields and authentication checks have already been successfully executed. |
| 6n | | TIPS | TIPS successfully executes the checks: - Access Rights check ; - Instructing Party authorised – creditor side . See 4.1- Business Rules for details. |
| 5e | FIToFIPaymentStatusReport (Euro currency) or FIToFIPaymentStatusReport (pacs.002.001.10) (non-Euro currency) | TIPS as sender Recall Assignee as receiver | TIPS unsuccessfully executes the checks listed in step 6n . At the first negative check the system stops and sends a message to the Recall Assignee - same DN of the Sender – containing the proper error code. See 4.1- Business Rules for details. |
| 7n | | TIPS | The DN of the Recall Assigner is identified in the "Outbound DN-BIC Routing" mapping table from the field Assignee (ResolutionOfInvestigation). |

| Step | Involved messages | Involved actors | Description |
|------|--|---|--|
| 8n | ResolutionOfInvestigation (Euro currency) or ResolutionOfInvestigation (camt.029.001.09) (non-Euro currency) | TIPS as sender Recall Assigner as receiver | TIPS forwards the negative response received to the Recall Assigner DN. |
| 5p | PaymentReturn (Euro currency) or PaymentReturn (pacs.004.001.09) (non-Euro currency) | Recall Assignee as sender TIPS as receiver | The Recall Assignee sends a positive response and it is successfully delivered to TIPS. Technical validation, check of mandatory fields and authentication checks have already been successfully executed. |
| 6p | | TIPS | TIPS successfully executes the checks: - Access Rights check ; - Instructing Party authorised – creditor side ; - Originator Account or CMB existence ; - Beneficiary Account or CMB existence ; - Maximum Amount not exceeded for Returned Amount . See 4.1- Business Rules for details. |
| 6e | FIToFIPaymentStatusReport (Euro currency) or FIToFIPaymentStatusReport (pacs.002.001.10) (non-Euro currency) | TIPS as sender Recall Assignee as receiver | TIPS unsuccessfully executes the checks listed in step 6p . At the first negative check the system stops and sends a message to the Recall Assignee - same DN of the Sender – containing the proper error code. The status of the positive Recall Response is set to “Failed”. In this case the Recall Assignee can submit a new Recall Response in order to close the Recall business case. The message validation will restart from the step 5p . See 4.1- Business Rules for details. |
| 7p | | TIPS | TIPS successfully executes the check: - Duplicate check for positive Recall . See 4.1- Business Rules for details. |

| Step | Involved messages | Involved actors | Description |
|------|---|---|---|
| 7e | FIToFIPaymentStatusReport (Euro currency) or FIToFIPaymentStatusReport (pacs.002.001.10) (non-Euro currency) | TIPS as sender Recall Assignee as receiver | <p>TIPS unsuccessfully executes the check in step 7p. The system stops and sends a message to the Recall Assignee – same DN of the sender – containing the proper error code.</p> <p>The status of the positive Recall Response is set to “<i>Failed</i>”. In this case the Recall Assignee can submit a new positive Recall Response in order to close the Recall business case. The message validation will restart from the step 5p.</p> <p>See 4.1- Business Rules for details.</p> |
| 8p | | TIPS | <p>TIPS combines the information embedded in the PaymentReturn message to determine a payment transaction dataset to send to the Check and Execute Instruction process.</p> <p>The status of the positive Recall Response is set to “<i>Validated</i>”.</p> |
| 9p | | TIPS | <p>The Amount to be settled (AT046 – DS-06) is retrieved and saved as information related to the transaction dataset. From now on, this amount is referred to as “Settlement Amount”.</p> <p>The Settlement date for the positive Recall Response (R7 – DS-06) is retrieved and saved as information related to the transaction dataset. From now on, this date is referred to as “Settlement Date”.</p> <p>The Recall Reference of the PSP initiating the Recall (R6 – DS-06) is retrieved and saved as information related to the transaction dataset. From now on, this reference is referred to as “Transaction Identification”</p> |

| Step | Involved messages | Involved actors | Description |
|------|-------------------|-----------------|--|
| 10p | | TIPS | <p>Given the fact that the original Beneficiary Participant (field AT-C002 in DS-02, subset of DS-06) has to be interpreted as the new Originator Participant for the reversed cash flow, TIPS determines the account or CMB to be debited from the configured accounts information, the Beneficiary BIC and the currency within the PaymentReturn message.</p> <p>In details:</p> <ul style="list-style-type: none"> - The system verifies that an account, of either type "TIPS Account" or "TIPS AS Technical Account", exists and is linked to the Beneficiary Participant (field "Beneficiary BIC") as authorised user and has a currency equal to the one defined in the Returned Amount. - If no Account is linked to the Beneficiary Participant, the system looks for a CMB linked to the Beneficiary (field "Beneficiary BIC") as user; - The system selects the account linked to the CMB; the account related to the CMB must have a currency equal to the one defined in the Returned Amount. <p>From now on, the account is referred to as "Originator Account" and the possible CMB as "Debiting CMB".</p> |
| 11p | | TIPS | <p>Given the fact that the original Originator Participant (field AT-D002 in DS-02, which is part of DS-06) has to be interpreted as the new Beneficiary Participant for the reversed cash, TIPS determines the account or CMB to be credited from the configured accounts information, the Originator BIC and the currency within the PaymentReturn message.</p> <p>In details:</p> <ul style="list-style-type: none"> - The system verifies that an account, of either type "TIPS Account" or "TIPS AS Technical Account", exists and is linked to the Originator Participant (field "Originator BIC") as authorised user and has a currency equal to the one defined in the Returned Amount. - If no Account is linked to the Originator Participant, the system looks for a CMB linked to the Originator (field "Originator BIC") as user; - The system selects the account linked to the CMB; the account related to the CMB must have a currency equal to the one defined in the Returned Amount. <p>From now on, the account is referred to as "Beneficiary Account" and the possible CMB as "Crediting CMB".</p> |

| Step | Involved messages | Involved actors | Description |
|------|--|---|--|
| 12p | | TIPS | TIPS successfully executes the checks: <ul style="list-style-type: none"> - Originator Account/CMB not blocked; - Beneficiary Account/CMB not blocked; - Available amount not exceeded. See 4.1- Business Rules for details. |
| 12e | FIToFIPaymentStatusReport (Euro currency) or FIToFIPaymentStatusReport (pacs.002.001.10) (non-Euro currency) | TIPS as sender Recall Assignee as receiver | TIPS unsuccessfully executes the checks listed in step 12p . At the first negative check the system stops and sends a message to the Recall Assignee (the new Originator DN) containing the proper error code. The status of the positive Recall Response is set to "Failed". In this case the Recall Assignee can submit a new positive Recall Response in order to close the Recall business case. The message validation will restart from the step 5p . See 4.1- Business Rules for details. |
| 13p | | TIPS | TIPS settles the full amount of the payment transaction, debiting the Originator Account and adding the same positive amount to the Beneficiary Account. If a Debiting/Crediting CMB is involved, the system decreases/increases its Headroom by the same amount. TIPS sets the positive Recall Response status to "Settled". |
| 14p | PaymentReturn (Euro currency) or PaymentReturn (pacs.004.001.09) (non-Euro currency) | TIPS as sender Recall Assigner as receiver | TIPS forwards the positive response received from the Recall Assignee to the Recall Assigner (the new Beneficiary DN). |
| 15p | FIToFIPaymentStatusReport (Euro currency) or FIToFIPaymentStatusReport (pacs.002.001.10) (non-Euro currency) | TIPS as sender Recall Assignee as receiver | TIPS generates a positive Payment status report and send it to the Recall Assignee (the new Originator DN). |

| Step | Involved messages | Involved actors | Description |
|------|-------------------------------|---|---|
| 16p | ReturnAccount | TIPS as sender Debited Account and/or CMB Owner | <p>TIPS checks the "Floor notification amount" configured for the involved Originator Account or Debiting CMB. If the account balance or the CMB headroom after settlement is confirmed is lower than the "floor notification amount", TIPS sends a ReturnAccount to the Account and/or CMB owners involved in the transaction.</p> <p>The message is sent to the default DN of the Account Owner and/or CMB Owner. The message contains the - Originator Account Number or the Debiting CMB Number.</p> |
| 17p | ReturnAccount | TIPS as sender Credited Account and/or CMB Owner | <p>TIPS checks the "Ceiling notification amount" configured for the involved Beneficiary Account or Crediting CMB. If the account balance or the CMB headroom after the confirmed settlement is greater than the "ceiling notification amount", TIPS sends a ReturnAccount to the Account and/or CMB owners involved in the transaction.</p> <p>The message is sent to the default DN of the Account Owner and/or CMB Owner. The message contains the Beneficiary Account Number or the crediting CMB Number.</p> |

2.3.1. Examples

This sub-section presents examples of different scenarios related to the Recall process.

Scenarios and examples are not exhaustive and limited to Recall requests related to transactions denominated in Euro currency⁴⁰.

The first and the second ones describe successful scenarios where a positive and a negative Recall Response are provided by the Recall Assignee respectively; the third one outlines the rejection of a positive Recall Response⁴¹ which failed the Duplicate check. The last one describes the request for status update on a Recall.

The below table summarises, for each reference data object mentioned in the following examples, the related configuration.

Figure 119 – Recall examples: data constellation

| CASH ACCOUNT | | | | | |
|--------------|------------------|------------|------------|--------------|----------------|
| ACCOUNT | TIPS PARTICIPANT | VALID FROM | VALID TO | FLOOR AMOUNT | CEILING AMOUNT |
| ACCOUNT1 | PRTYABMMXXX | 01/12/2017 | 31/12/9999 | 100€ | 1.050.000€ |
| ACCOUNT2 | PRTYBCMMXXX | 01/12/2017 | 31/12/9999 | 200€ | 1.000.000€ |

| CRDM – STATIC DATA | | AUTHORIZED ACCOUNT USER | |
|--|---------------------------|-------------------------|-------------|
| DN | PARENT BIC – PARTY BIC | ACCOUNT | ACTOR |
| <ou=dept_123, o=prtyabmmxxx, o=a2anet> | NCBOEURIXXX - PRTYABMMXXX | ACCOUNT1 | PRTYABMMXXX |
| <ou=dept_abc, o=prtybcmxxx, o=a2anet> | NCBOEURIXXX - PRTYBCMMXXX | ACCOUNT2 | PRTYBCMMXXX |

| Inbound DN BIC ROUTING | | Outbound DN BIC ROUTING | |
|--|-------------|--|-------------|
| DN | ACTOR | DN | ACTOR |
| <ou=dept_123, o=prtyabmmxxx, o=a2anet> | PRTYABMMXXX | <ou=dept_123, o=prtyabmmxxx, o=a2anet> | PRTYABMMXXX |
| <ou=dept_abc, o=prtybcmxxx, o=a2anet> | PRTYBCMMXXX | <ou=dept_abc, o=prtybcmxxx, o=a2anet> | PRTYBCMMXXX |

2.3.1.1. Successful scenario – Positive Recall Response

In this scenario:

- The current business date is 28/12/2017;

⁴⁰ Except for the involved messages, the processing described by means of the above examples is the same also for Recall requests related to transactions in a non-Euro currency,

⁴¹ It is worth noting that the 'Recall Answer' terminology is kept for the non-Euro currency schemes (and in the corresponding message descriptions in chapter 3). This term is fully equivalent to the 'Recall Response' term adopted in SCT-Inst scheme.

- A TIPS Participant (PRTYABMMXXX) sends a [FIToFIPaymentCancellationRequest](#) message to TIPS in order to request the cancellation of an Instant Payment transaction (OrigID1) previously settled on 25/12/2017;

Figure 120 – Recall successful scenario: positive response – FIToFIPaymentCancellationRequest

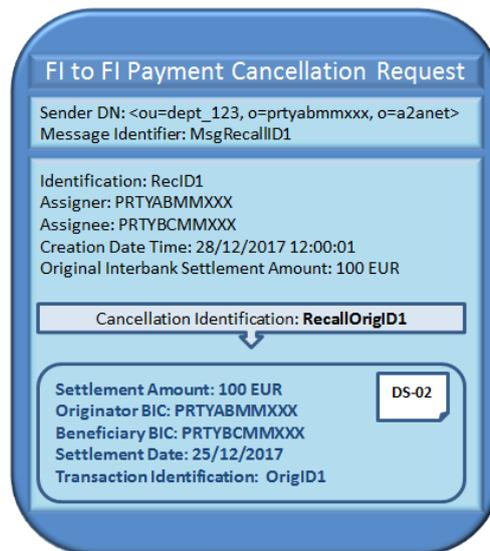

- TIPS, after performing the expected checks successfully:
 - o It identifies the DN of the Assignee (<ou=dept_123, o=prtybcmxxx, o=a2anet>);
 - o It forwards the FIToFIPaymentCancellationRequest message to the Recall Assignee DN.
- The Recall Assignee (PRTYBCMMXXX) accepts the request by sending to TIPS the following [PaymentReturn](#) message.

Figure 121 – Recall successful scenario: positive response – PaymentReturn



- TIPS successfully proceeds with the required validation in the context of access rights and duplicate check;
- TIPS determines the payment transaction dataset which reverses the direction of the cash flow from the original payment transaction that is recalled.

Figure 122 – Recall successful scenario: positive response – Recall Dataset

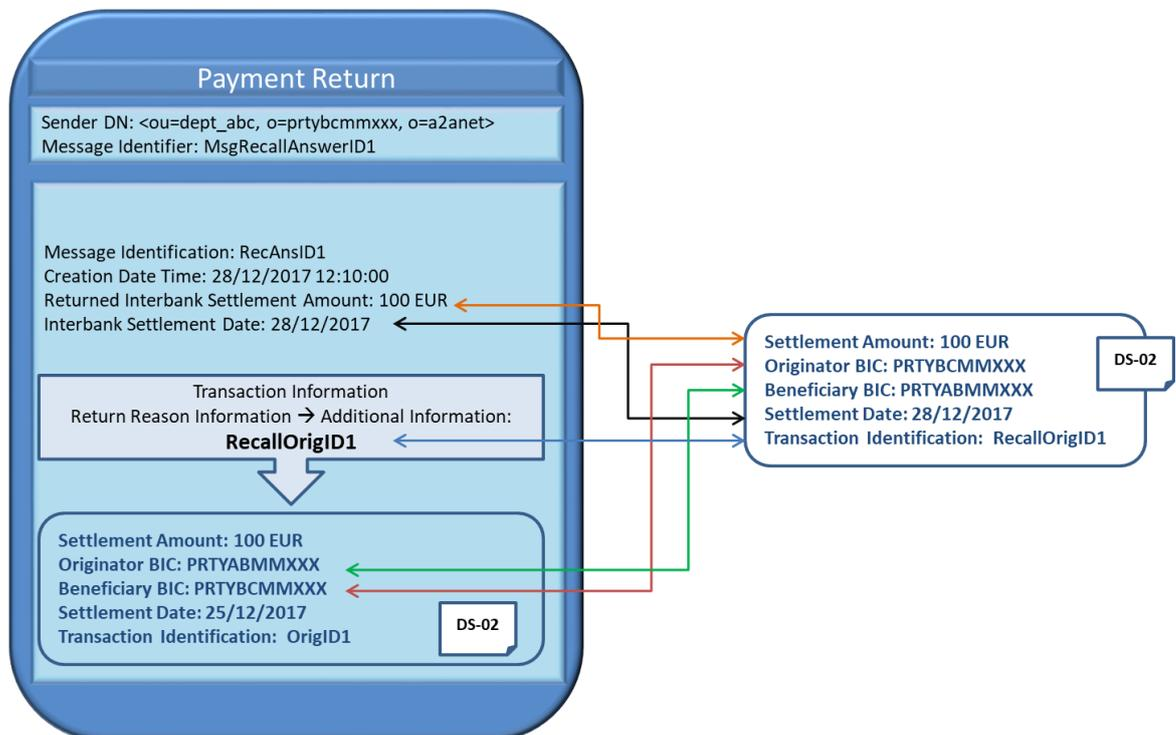

- The system:

- It identifies the Originator Account (ACCOUNT2) from the Originator BIC;
- It identifies the Beneficiary Account (ACCOUNT1) from the Beneficiary BIC;
- It settles the full amount of the payment transaction debiting the Originator Account of 100.00 EUR and adding the same positive amount to the Beneficiary Account.

Figure 123 – Recall successful scenario: positive response – Settlement Process

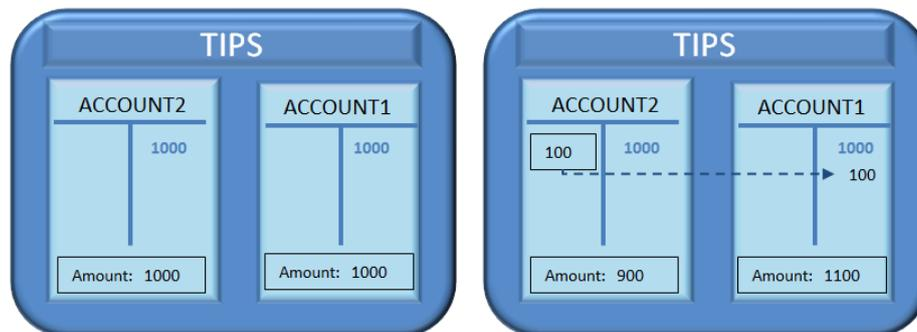

- TIPS identifies the Beneficiary DN and Originator DN from the “Outbound DN-BIC Routing” (<ou=dept_123, o=prtyabmmxxx, o=a2anet> / <ou=dept_abc, o=prtybcmxxx, o=a2anet>);
- The system forwards the PaymentReturn message to the Beneficiary Participant (the Recall Assigner) and sends a [FIToFIPaymentStatusReport](#) message to the Originator DN (the Recall Assignee) after settlement of the recall took place.

2.3.1.2. Successful scenario – Negative Recall Response

In this scenario:

- The current business date is 28/12/2017;
- A TIPS Participant (PRTYABMMXXX) sends a [FIToFIPaymentCancellationRequest](#) message to TIPS in order to request the cancellation of a Payment transaction (OrigID1) previously settled on 25/12/2017.

Figure 124 – Recall successful scenario: negative response – FItoFIPaymentCancellationRequest

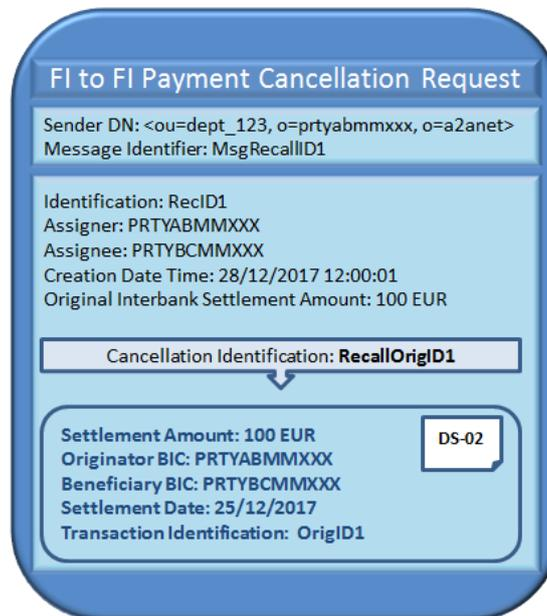

- TIPS, after performing the expected checks successfully:
 - o It identifies the DN of the Assignee (<ou=dept_abc, o=prtybcmxxx, o=a2anet>);
 - o It forwards the [FIToFIPaymentCancellationRequest](#) message to the Recall Assignee DN.
- The Recall Assignee (PRTYBCMMXXX) rejects the request by sending to TIPS the following [ResolutionOfInvestigation](#) message:

Figure 125 – Recall successful scenario: negative response – ResolutionOfInvestigation

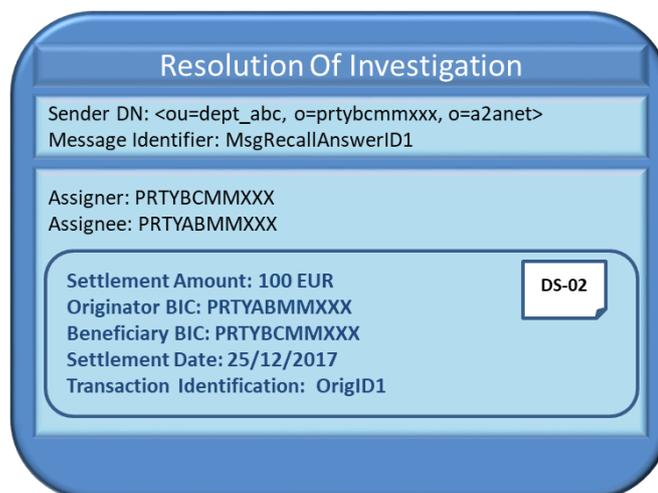

- TIPS successfully proceeds with the required checks;

- TIPS identifies the DN of the Assignee (<ou=dept_123, o=prtyabmmxxx, o=a2anet>) and forwards the ResolutionOfInvestigation message to the Assignee DN.

2.3.1.3. Unsuccessful scenario – Recall Response Duplicate check failed

In this scenario:

- The current business date is 28/12/2017;
- A TIPS Participant (PRTYABMMXXX) sends a [FIToFIPaymentCancellationRequest](#) message to TIPS in order to request the cancellation of a Payment transaction (OrigID1) previously settled on 25/12/2017.

Figure 126 – Recall unsuccessful scenario: Duplicate check failed – FIttoFIPaymentCancellationRequest

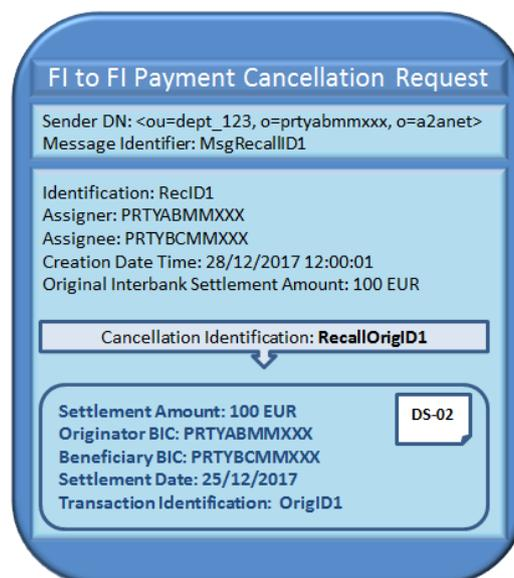

- TIPS, after performing the expected checks successfully:
 - o It identifies the DN of the Assignee (<ou=dept_abc, o=prtybcmxxx, o=a2anet>);
 - o It forwards the [FIToFIPaymentCancellationRequest](#) message to the Recall Assignee DN.
- The Recall Assignee (PRTYBCMMXXX) accepts the request by sending to TIPS the following [PaymentReturn](#) message.

Figure 127 – Recall unsuccessful scenario: Duplicate check failed – PaymentReturn



- TIPS proceeds with the required validation in the context of access rights and duplicate check and detects a duplicate submission: the couple Return Identification and Beneficiary BIC (AT-C002 DS-02 subset of DS-06) embedded within the [PaymentReturn](#) message already exists as a couple Transaction Identification/Originator BIC in the list of transactions of the last X days, where X is equal to the system parameter "[Retention Period](#)".

Figure 128 – Recall unsuccessful scenario: Duplicate check failed – Duplicate submission

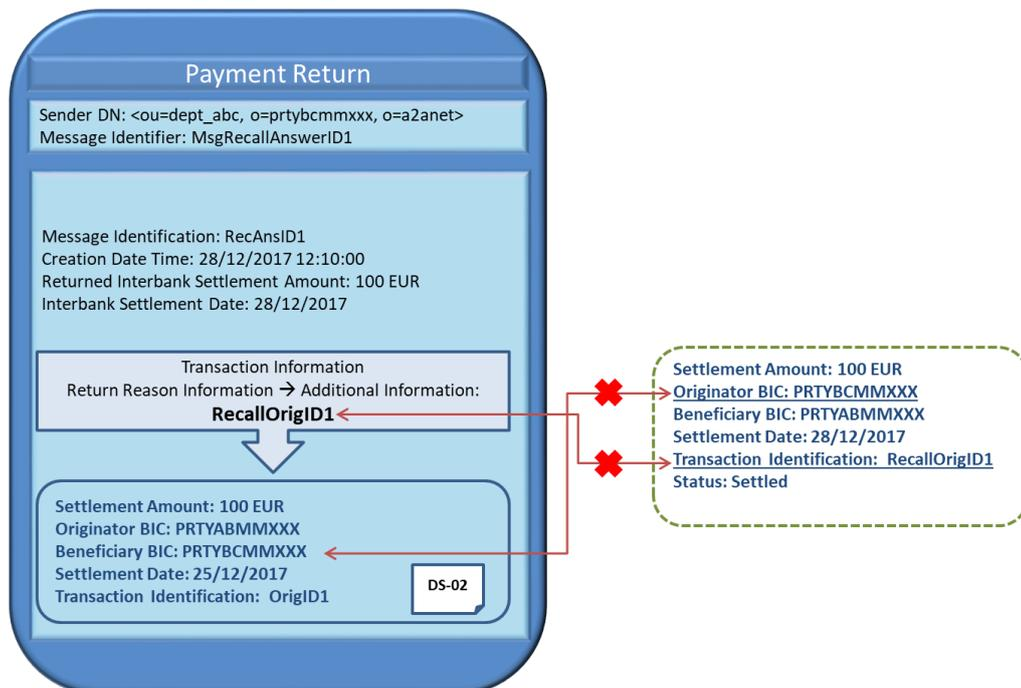

- The following [FIToFIPaymentStatusReport](#) message is sent by TIPS to the Recall Assignee – same DN of the sender – to reject the positive Recall Response.

**Figure 129 – Recall unsuccessful scenario: Duplicate check failed –
FIToFIPaymentStatusReport**

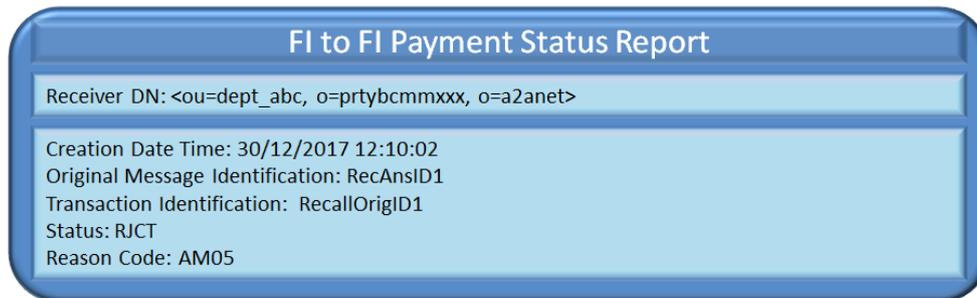

2.3.1.4. Successful scenario – Request for Status Update on a Recall

In this scenario:

- The current business date is 18/01/2018;
- A TIPS Participant (PRTYABMMXXX) sends a [FIToFIPaymentStatusRequest](#) message to TIPS in order to request a status update on a Recall. The Recall has been previously sent on 28/12/2017 (RecallOrigID1) and it is linked to the Payment transaction (OrigID1) previously settled on 25/12/2017. For the Recall transaction (RecallOrigID1), the TIPS Participant did not receive neither a Positive nor a Negative Response from the Beneficiary Participant.

Figure 130 – Successful request for Status Update on a Recall

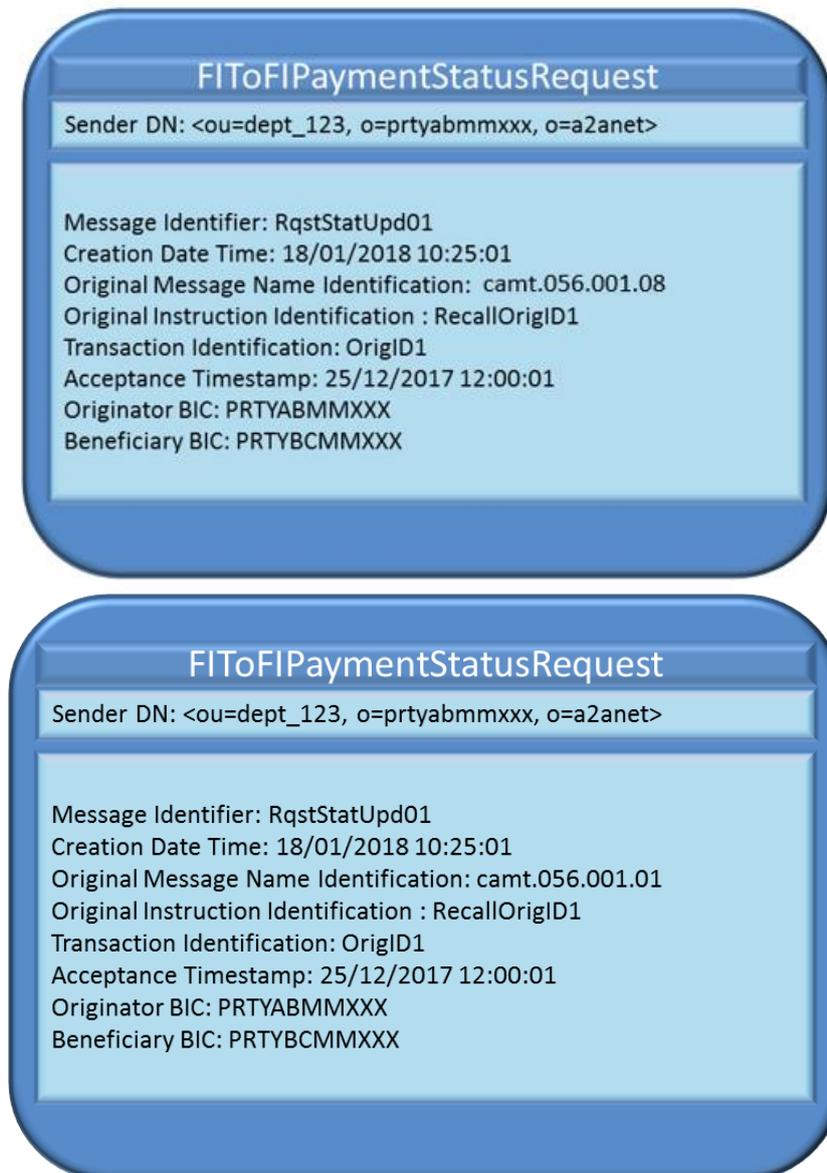

- TIPS, after performing the expected checks successfully:
 - o It identifies the DN of the Assignee (<ou=dept_abc, o=prtybcmxxx, o=a2anet>);
 - o It forwards the FIToFIPaymentStatusRequest message to the Recall Assignee DN.

2.3.1.5. Successful scenario – Positive Recall Response with Ancillary System processing

In this scenario:

- The current business date is 28/12/2021;
- A TIPS Participant (PRTYABMMXXX) sends a [FIToFIPaymentCancellationRequest](#) message to TIPS in order to request the cancellation of an Instant Payment transaction (OrigID1) previously settled on 25/12/2021, whose credited account was the TIPS AS Technical Account (TIPSASTACC1) owned by an Ancillary System (ANSYPRMMXXX);

- The credited Beneficiary PSP was the Reachable Party (PRTYADMMXXX) served by the Ancillary System;

Figure 131 – Recall successful scenario: positive response – FItoFIPaymentCancellationRequest

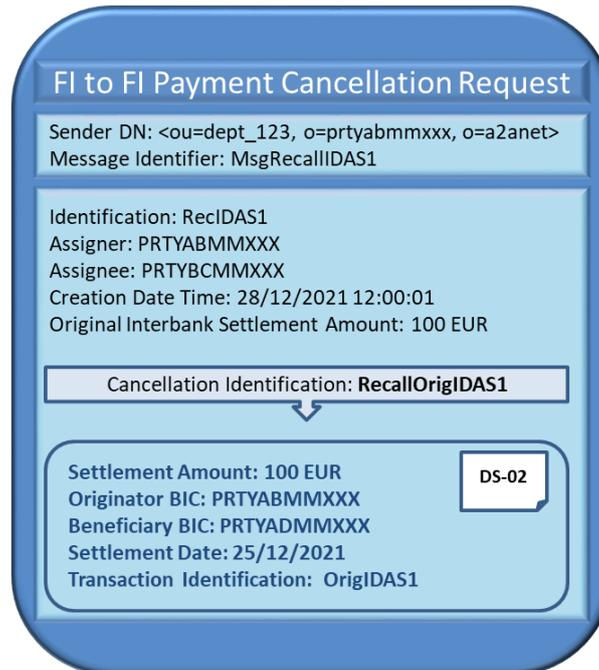

- TIPS, after performing the expected checks successfully:
 - o It identifies the DN of the Assignee (<ou=ach_123, o=ansyprmmxxx, o=a2anet>);
 - o It forwards the FIToFIPaymentCancellationRequest message to the Recall Assignee DN.
- The Recall Assignee (PRTYADMMXXX) accepts the request via its Ancillary System that sends to TIPS the following [PaymentReturn](#) message.

Figure 132 – Recall successful scenario: positive response – PaymentReturn



- TIPS successfully proceeds with the required validation in the context of access rights and duplicate check;
- TIPS determines the payment transaction dataset which reverses the direction of the cash flow from the original payment transaction that is recalled.

Figure 133 – Recall successful scenario: positive response – Recall Dataset

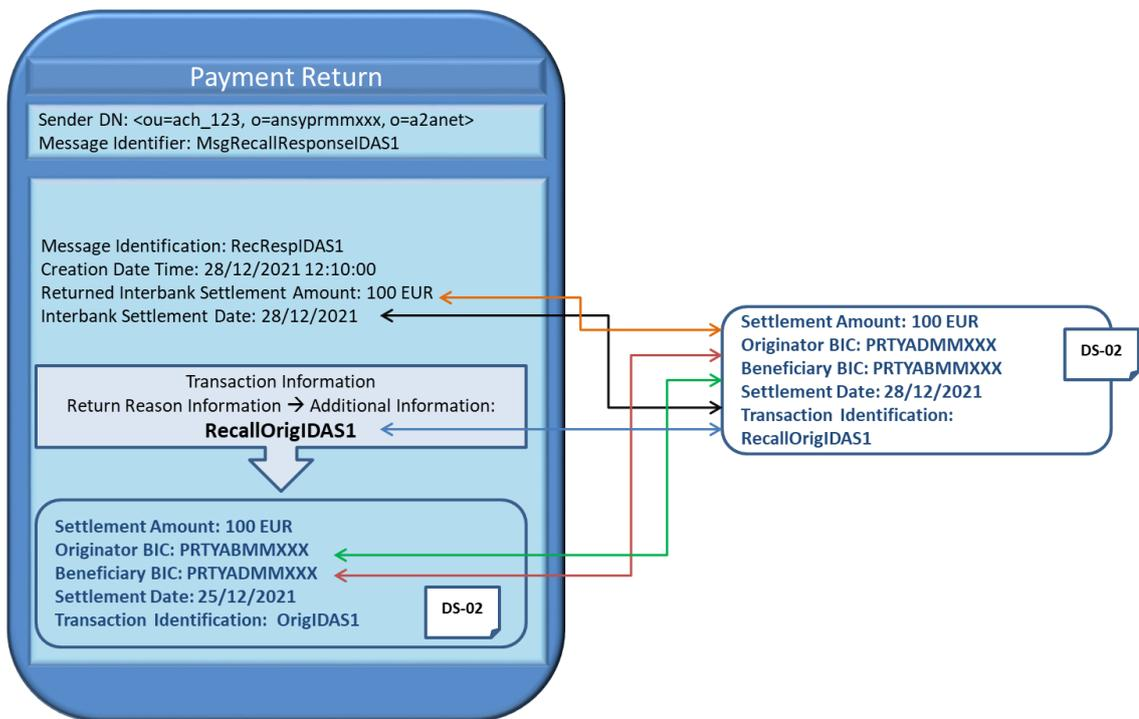

- The system:
 - o It identifies the Originator Account (TIPASTACC1) from the Originator BIC;
 - o It identifies the Beneficiary Account (ACCOUNT1) from the Beneficiary BIC;
 - o It settles the full amount of the payment transaction by debiting TIPASTACC1 of 100.00 EUR and crediting the same amount to the ACCOUNT1.

Figure 134 – Recall successful scenario: positive response – Settlement Process

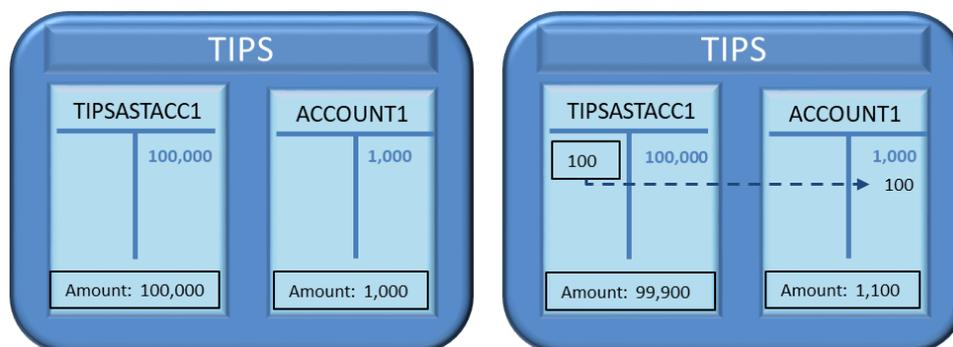

- TIPS identifies the Beneficiary DN and Originator DN from the “Outbound DN-BIC Routing” (<ou=dept_123, o=prtyabmmxxx, o=a2anet> / <ou=ach_123, o=ansyprmmxxx, o=a2anet>);
- The system forwards the PaymentReturn message to the Beneficiary Participant (the Recall Assigner) and sends a [FIToFIPaymentStatusReport](#) message to the Originator DN (the Recall Assignee) after settlement of the recall took place.

2.4. Investigation

This section focuses on the processing of an Investigation Request, with the description of the full scenario and its steps. The same processing also applies in respect of Investigation Request for transactions denominated in a non-Euro currency⁴².

The transaction status investigation process can be initiated by Participants, Ancillary Systems or Instructing Parties acting on behalf of Participants or Reachable Parties on the originator side using the transaction status inquiry message, allowing the TIPS Actors to retrieve the last generated payment transaction status advice for each transaction referenced in the investigation request.

TIPS answers to an investigation request only if it is received when the time-out period for Instant Payment transaction is expired for more than 5 seconds (Investigation Offset + SCT^{Inst} Timestamp Timeout), as indicated in the SCT^{Inst} scheme rulebook. In the non-Euro currency scheme the Investigation can be triggered after a reduced time calculated on the basis of Instant Payment Timeout and the Investigation Offset (non-Euro currency) parameters.

If the Investigation message is correctly received, for each of the transaction referenced in the investigation request, if the transaction is existing and still *Reserved* (meaning that no Beneficiary side confirmation/rejection has been received and no sweeping has been performed), then TIPS assumes that the Instant Payment is timed-out. In this case, TIPS does not answer to the Investigation directly, but set to *Expired* the Instant Payment transaction, informing both Originator and Beneficiary side accordingly (see [2.2.1.1 "Timeout scenario: missing/delayed Beneficiary-side answer"](#)⁴³).

Involved actors and messages are:

- The Participant, Ancillary System or Instructing Party sending the Investigation Request;
- [FIToFIPaymentStatusRequest](#) message in order to instruct Investigation;
- [FIToFIPaymentStatusReport](#) message in order to receive last generated payment transaction status advice.

For non-Euro currency scheme the involved messages are:

- [FIToFIPaymentStatusRequest \(pacs.028.001.03\)](#) message in order to instruct Investigation;
- [FIToFIPaymentStatusReport \(pacs.002.001.10\)](#) message in order to receive last generated payment transaction status advice.

All the described scenarios are triggered under the assumption that the technical validation, check of mandatory fields and authentication of the user have already been successfully performed by ESMIG.

It is important to keep in mind that when the [FIToFIPaymentStatusRequest](#) message contains a BIC8 instead of a BIC11, the message is accepted and the string is completed appending "XXX" at the end of the BIC8 for further processing. All the steps are described considering BIC11 only.

⁴² For details regarding the messages involved in the process of an Investigation Request related to transactions denominated in a non-Euro currency, please refer to [Table 77 – List of messages for non-Euro schemes](#).

⁴³ For Instant Payment transaction denominated in a non-Euro currency, please see [2.2.2.1 "Timeout scenario: missing/delayed Beneficiary-side answer \(non-Euro currencies scheme\)"](#).

This is the diagram describing the process and the involved actors. The details of the steps are described in the following table.

Figure 135 – Investigation Flow

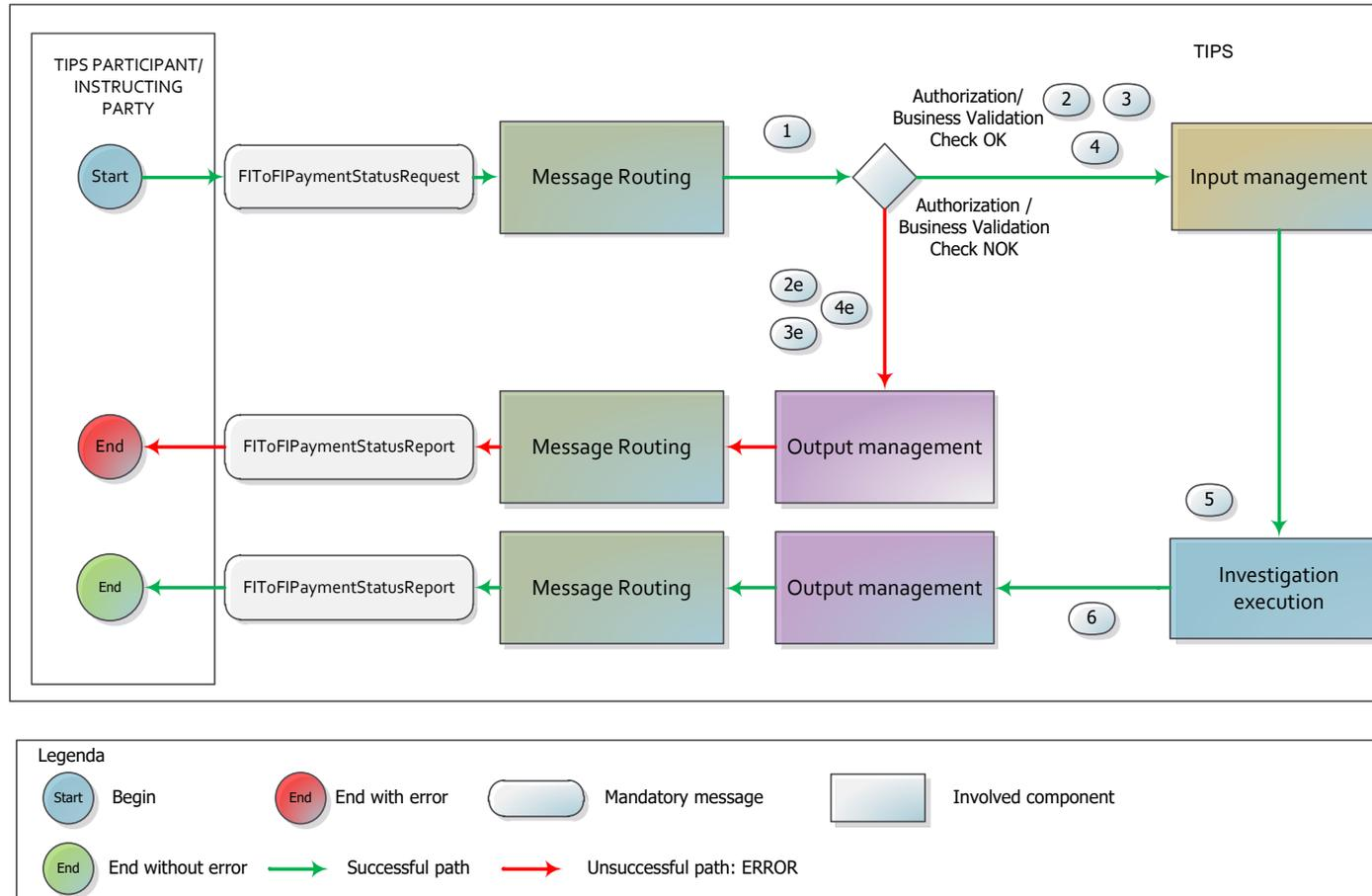

Table 62 – Investigation steps

| Step | Involved messages | Involved actors | Description |
|------|--|---|---|
| 1 | FIToFIPaymentStatusRequest (Euro currency) or FIToFIPaymentStatusRequest (pacs.028.001.03) (non-Euro currency) | Originator Participant, Ancillary System or Instructing Party as Sender TIPS as receiver | TIPS receives an incoming Investigation request from the Originator Participant, Ancillary System or Instructing Party. Technical validation, check of mandatory fields and authentication checks have already been successfully executed. |
| 2 | | TIPS | TIPS successfully executes the checks: - Access Rights check . See 4.1- Business Rules for details. |
| 2e | FIToFIPaymentStatusReport (Euro currency) or FIToFIPaymentStatusReport (pacs.002.001.10) (non-Euro currency) | TIPS as sender Originator Participant, Ancillary System or Instructing Party as receiver | TIPS unsuccessfully executes the checks of step 2 . At the first negative check the system stops and sends a message to the Originator Participant, Ancillary System or Instructing Party - same DN of the Sender – containing the error. |
| 3 | | TIPS | For each transaction referenced in the Investigation request, TIPS successfully executes the check: - Instructing Party authorised for queries ; - Payment Transaction existence ; - Payment Transaction existence in final status . See 4.1- Business Rules for details. |
| 3e | FIToFIPaymentStatusReport (Euro currency) or FIToFIPaymentStatusReport (pacs.002.001.10) (non-Euro currency) | TIPS as sender Originator Participant, Ancillary System or Instructing Party as receiver | TIPS unsuccessfully executes the check of step 3 . In the case of a negative check the system stops and sends a message to the Originator Participant, Ancillary System or Instructing Party – same DN of the Sender – containing the error. |

| Step | Involved messages | Involved actors | Description |
|------|---|--|--|
| 4 | | TIPS | <p>TIPS successfully executes the check: - Investigation allowed.</p> <p>TIPS checks if the Investigation request has been received after the SCT^{Inst} Timestamp Timeout + Investigation Offset.</p> <p>See 4.1- Business Rules for details.</p> |
| 4e | <p>FIToFIPaymentStatusReport (Euro currency) or FIToFIPaymentStatusReport (pacs.002.001.10) (non-Euro currency)</p> | <p>TIPS as sender Originator Participant, Ancillary System or Instructing Party as receiver</p> | <p>TIPS unsuccessfully executes the check of step 4 for each transaction referenced in the Investigation request.</p> <p>In the case of a negative check the system stops the processing for the transaction and sends a message to the Originator Participant, Ancillary System or Instructing Party – same DN of the Sender – containing the error.</p> |
| 5 | | TIPS | <p>For each transaction referenced in the Investigation request, TIPS retrieves the last FIToFIPaymentStatusReport sent to the Participant initiating the investigation</p> |
| 6 | <p>FIToFIPaymentStatusReport (Euro currency) or FIToFIPaymentStatusReport (pacs.002.001.10) (non-Euro currency)</p> | <p>TIPS as sender Originator Participant, Ancillary System or Instructing Party as receiver</p> | <p>For each transaction referenced in the Investigation request, the system sends the last FIToFIPaymentStatusReport to the Originator Participant, Ancillary System or Instructing Party – same DN of the query Sender.</p> |

2.4.1. Examples

This sub-section presents two examples of the possible scenarios related to the transaction status investigation. Scenarios and examples are not exhaustive and limited to investigation requests related to transactions denominated in Euro⁴⁴.

The first one provides the example of a non-empty answer to a transaction status investigation request. The second one describes an example of a TIPS rejection for a transaction status investigation request.

The below table summarises, for each reference data object mentioned in the following examples, the related configuration.

Figure 136 – Transaction status investigation examples: data constellation

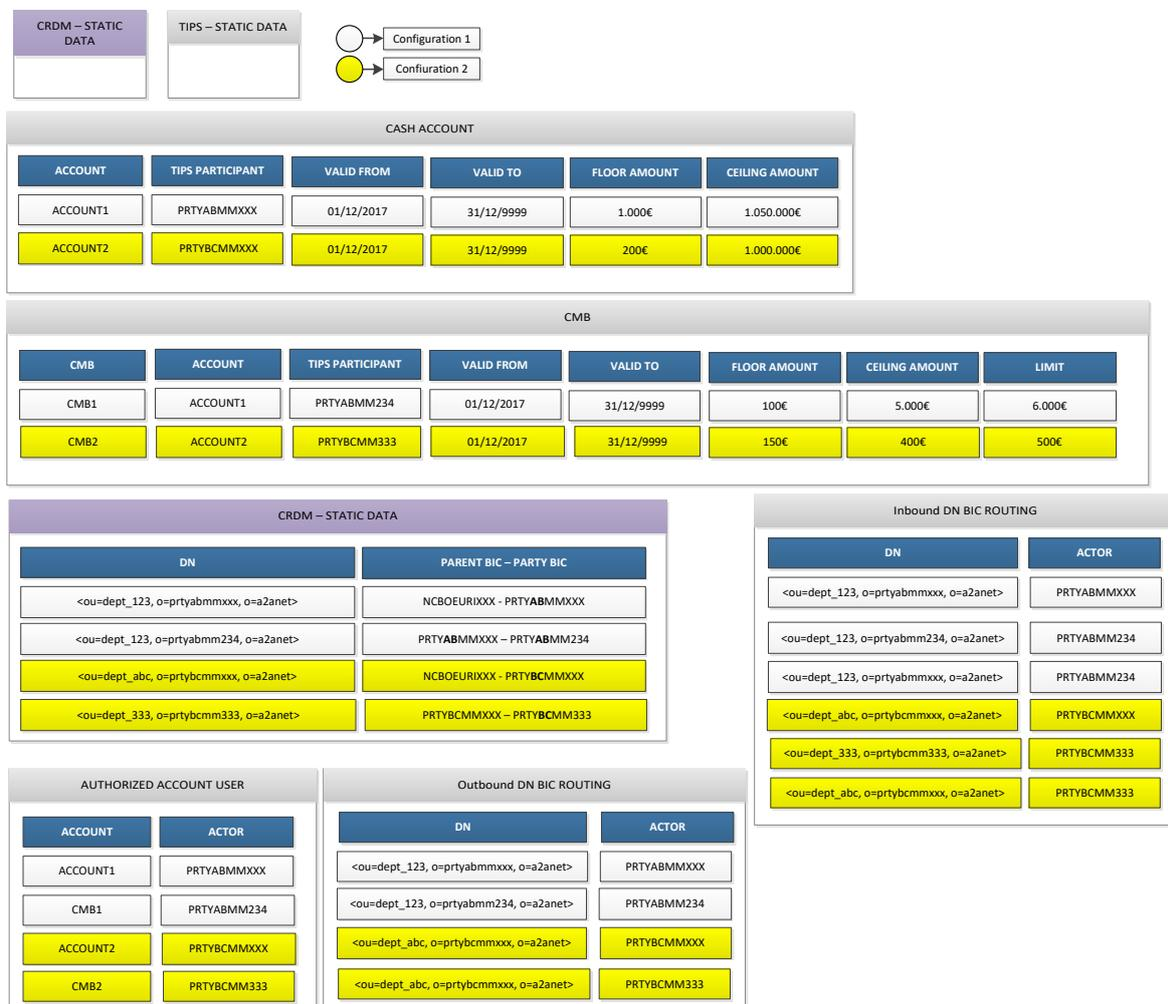

⁴⁴ Except for the involved messages and the customised time after which an investigation can be triggered, calculated on the basis of Instant Payment Timeout and the Investigation Offset for non-Euro currency parameters, the processing described by means of the above examples is the same also for Investigation Requests related to transactions in any non-Euro currency,

2.4.1.1. Successful scenario – Transaction status investigation

In this scenario:

- A TIPS Participant (PRTYABMMXXX) sent a [FIToFIPaymentStatusRequest](#) message to TIPS to investigate about an Instant Payment transaction (OrigID2). The timestamp of the [FIToFIPaymentStatusRequest](#) is 30/12/2017 12:01:12.
- Payment transaction OrigID2 is present in TIPS for the Originator BIC PRTYABMMXXX, and it has been successfully settled. The instruction OrigID2 has 30/12/2017 12:00:01 as acceptance timestamp.

Figure 137 – Successful FIToFIPaymentStatusRequest



- TIPS identifies:
 - o The DN of sender – i.e. the TIPS Participant or Instructing Party (<ou=dept_123, o=prtyabmmxxx, o=a2anet>);
 - o The Instant Payment transaction (OrigID2 for the Originator Participant (PRTYABMMXXX) with acceptance timestamp 30/12/2017 12:00:01);
 - o The TIPS actor instructing the [FIToFIPaymentStatusRequest](#) (PRTYABMMXXX).
- The Investigation request has been received after the Instant Payment transaction [SCT^{Inst} Timestamp Timeout](#) + [Investigation Offset](#);
- TIPS retrieves the last generated [FIToFIPaymentStatusReport](#) for the Originator;
- TIPS sends the [FIToFIPaymentStatusReport](#) to the same DN of the query Sender.

Figure 138 – Successful FIToFIPaymentStatusReport

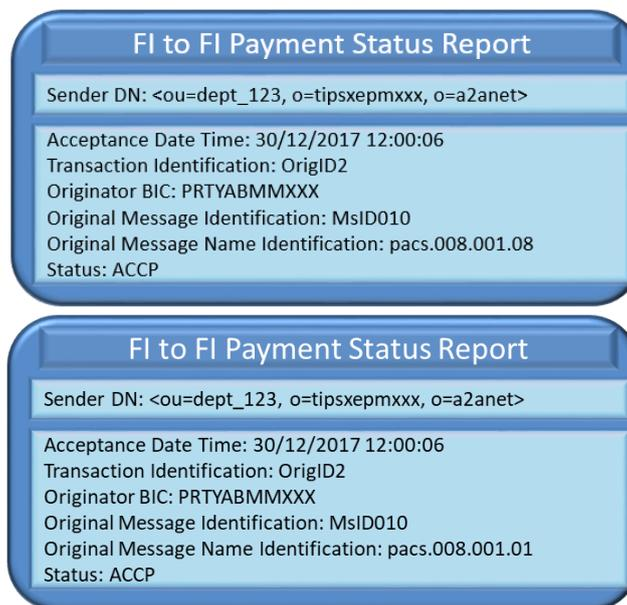

2.4.1.2. Unsuccessful scenario – Transaction status investigation

In this scenario:

- A TIPS Participant (PRTYABMMXXX) sent a [FIToFIPaymentStatusRequest](#) message to TIPS to receive information about an Instant Payment transaction (OrigID2); the timestamp of the [FIToFIPaymentStatusRequest](#) is 30/12/2017 12:00:10.
- Instant Payment transaction OrigID2 is present in TIPS for the Originator BIC PRTYABMMXXX, with acceptance timestamp 30/12/2017 12:00:01.

Figure 139 – Unsuccessful FIToFIPaymentStatusRequest



- TIPS identifies:
 - o The DN of sender – i.e. the TIPS Participant or Instructing Party (<ou=dept_123, o=prtyabmmxxx, o=a2anet>);
 - o The TIPS actor instructing the [FIToFIPaymentStatusRequest](#) (PRTYABMMXXX).
 - o The Instant Payment transaction (OrigID2) for the Originator Participant Party (PRTYABMMXXX), with acceptance timestamp 30/12/2017 12:00:01.

Since the [SCT^{Inst} Timestamp Timeout](#) is not expired for the Instant Payment transaction when the investigation request arrived, it cannot be satisfied.

- A [FIToFIPaymentStatusReport](#) message is sent by TIPS to the same DN of the query sender, containing the error.

Figure 140 – Unsuccessful FIToFIPaymentStatusReport

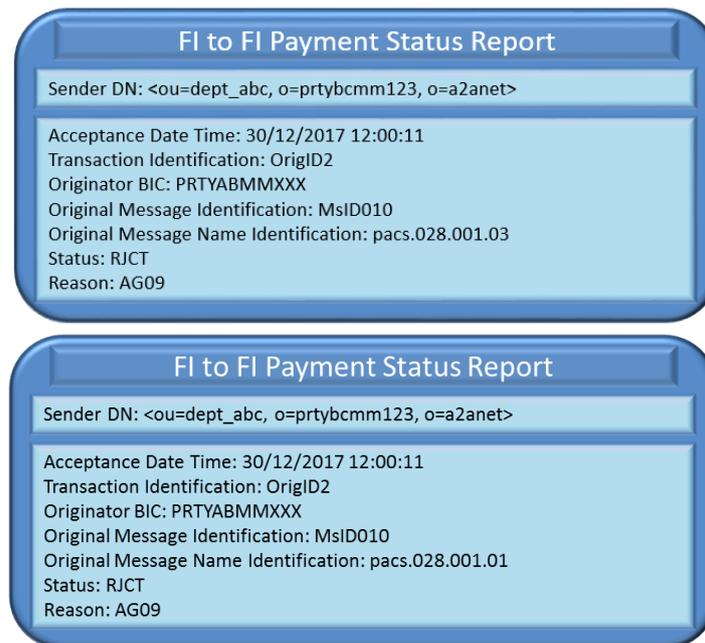

2.4.1.3. Successful scenario – Transaction status investigation generated by an Ancillary System

In this scenario:

- An Ancillary System (ANSYPRMMXXX) sends a [FIToFIPaymentStatusRequest](#) message to TIPS to investigate about a previously submitted Instant Payment transaction (OrigID2). The timestamp of the [FIToFIPaymentStatusRequest](#) is 30/12/2021 12:01:12.
- Payment transaction OrigID2 is present in TIPS for the Originator BIC PRTYADMMXXX, and it has been successfully settled. The instruction OrigID2 has 30/12/2021 12:00:01 as acceptance timestamp.

Figure 141 – Successful FIToFIPaymentStatusRequest originated by an AS



- TIPS identifies:
 - o The DN of sender – i.e. the Ancillary System (<ou=ach_123, o=ansyprmmxxx, o=a2anet>);
 - o The Instant Payment transaction (OrigID2 for the Originator Participant (PRTYADMMXXX) with acceptance timestamp 30/12/2021 12:00:01);
 - o The TIPS actor instructing the [FIToFIPaymentStatusRequest](#) (ANSYPRMMXXX).
- The Investigation request has been received after the Instant Payment transaction [SCT^{Inst} Timestamp Timeout](#) + [Investigation Offset](#);
- TIPS retrieves the last generated [FIToFIPaymentStatusReport](#) for the Originator Participant;
- TIPS sends the [FIToFIPaymentStatusReport](#) to the same DN of the query Sender.

Figure 142 – Successful FIToFIPaymentStatusReport forwarded to an AS

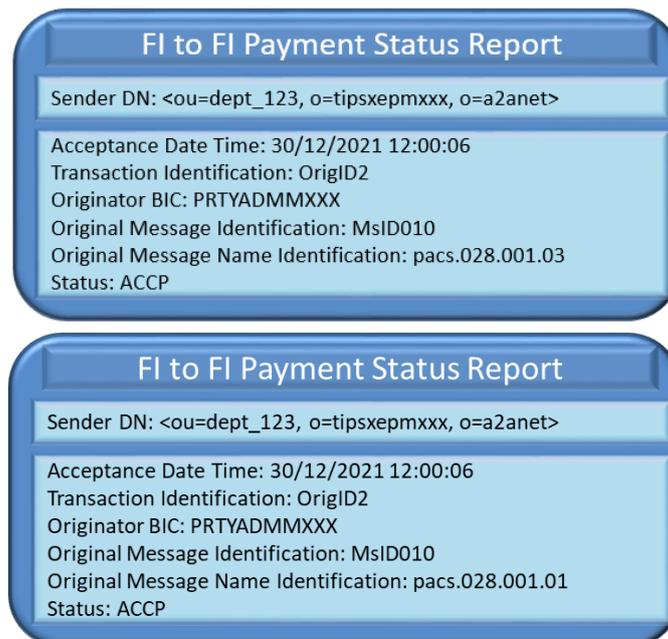

2.5. Inbound/Outbound and intra-service Liquidity Transfers

TIPS supports Central Bank Money transfers between accounts denominated in the same currency from TIPS to an RTGS System or vice versa from an RTGS System to TIPS.

Liquidity Transfer from a TIPS Account to an RTGS System account starts with the request sent by the TIPS Participant owner of the TIPS Account or by an Instructing Party on behalf of the TIPS Participant.

The Liquidity Transfer shall be initiated in TIPS in Application-to-Application mode (A2A) using the [Liquidity Credit Transfer](#) message or in User-to-Application mode (U2A) through a Graphic User Interface (GUI) and it is executed immediately.

For Liquidity Transfers from RTGS System accounts to TIPS Accounts, transfers must be initiated in the RTGS System by the debited RTGS System account holder; the Liquidity Transfer is then forwarded by the RTGS System to TIPS through the A2A interface.

Provided that both the RTGS System account and the TIPS Account are denominated in the same currency and that the RTGS System is connected to TIPS (and known to TIPS), it is possible to transfer liquidity from any RTGS System account to any TIPS Account.

Additionally, intra-service Liquidity Transfers between a TIPS Account and a TIPS AS Technical Account (or vice versa) are supported.

2.5.1. Inbound Liquidity Transfer

This section describes the processing of an Inbound Liquidity Transfer received in TIPS via [Liquidity Credit Transfer](#) message. Inbound Liquidity Transfer has to be initiated by the RTGS System account holder (or any authorised third party) in the relevant RTGS System (i.e. Inbound Liquidity Transfers cannot be triggered in TIPS). Indeed, the following section does not cover the starting part of the scenario where the RTGS system Participant requests to transfer the liquidity from the RTGS System account to a TIPS Account as it is out of the scope of TIPS. Examples of possible scenarios are described in the following sub-section.

The following Actors are involved in the processing of an Inbound Liquidity Transfer:

- The RTGS System that sends to TIPS the liquidity transfer order;
- TIPS that receives and confirms the request to the RTGS System;
- TIPS Account owner (or the default DN configured as receiver) which is duly informed if the account is credited or if its balance exceeds the configured threshold.

The following messages are involved in the Inbound Liquidity Transfer process:

- [LiquidityCreditTransfer](#): the message with which the RTGS System instructs the transfer of a cash amount from an RTGS System account to a TIPS Account denominated in the same currency;
- [Receipt \(camt.025.001.04\)](#): the message sent by TIPS to the RTGS System to confirm/reject the execution of a Liquidity Transfer;

-
- [BankToCustomerDebitCreditNotification](#): the message sent by TIPS to report the settlement of a liquidity transfer to the TIPS Account owner (or the default DN configured as receiver). The notification is sent out only if previously configured by the Account owner.
 - [ReturnAccount](#): the message sent by TIPS to notify the owner of the credited TIPS Account (or the default DN configured as receiver) that the ceiling threshold is exceeded. The notification is generated for the Account owner only if the ceiling threshold is configured.

The process is graphically described in the following flow.

Figure 143 – Inbound Liquidity Transfer Order flow

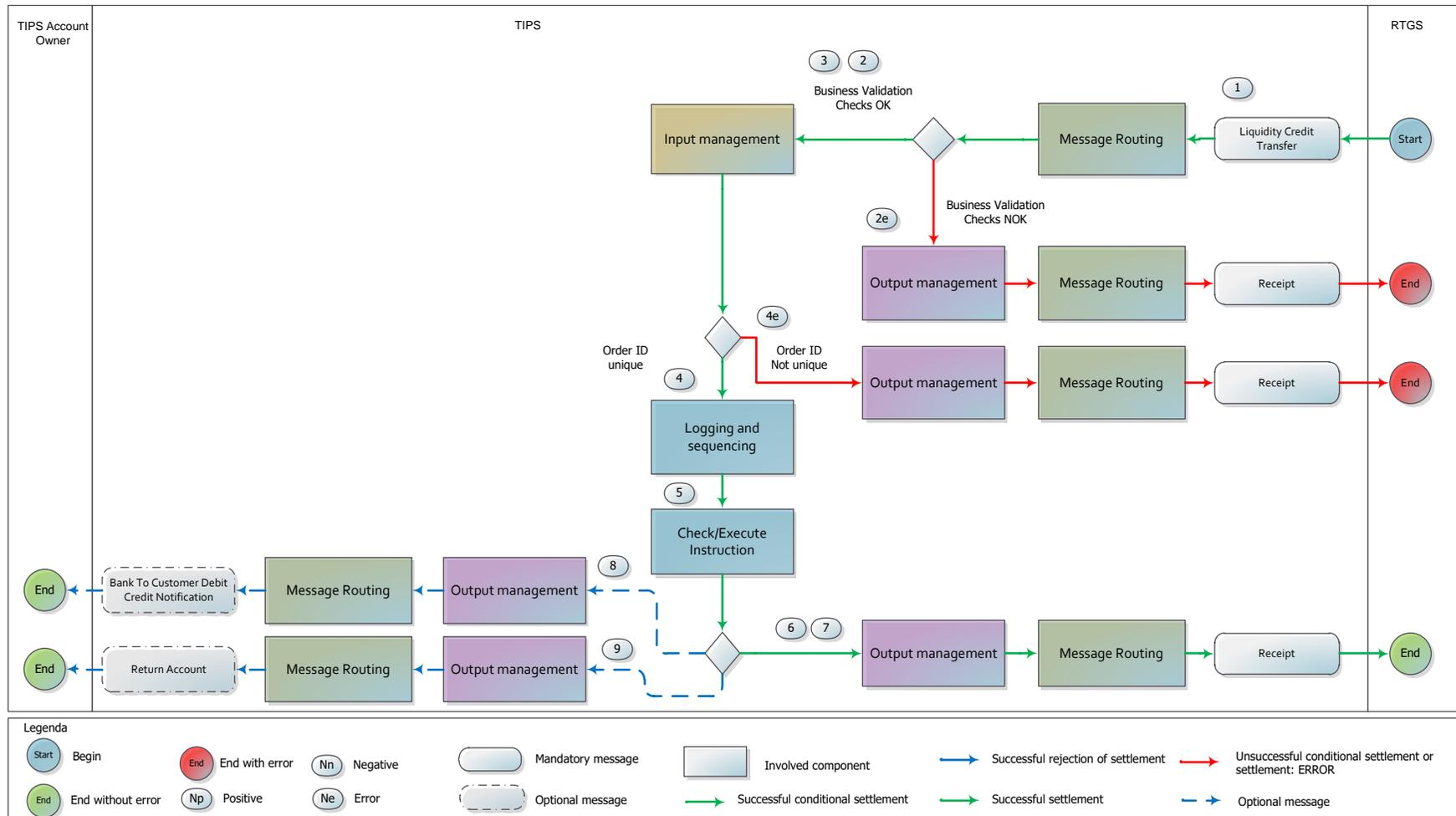

The details on the single steps are described in the following table.

Table 63 – Inbound Liquidity Transfer Order steps

| Step | Involved messages | Involved actors | Description |
|------|---|---|--|
| 1 | LiquidityCreditTransfer | RTGS System as Sender TIPS as receiver | TIPS receives an incoming Liquidity transfer request from the RTGS System. Technical validation, check of mandatory fields and authentication checks have already been successfully executed. |
| 2 | | TIPS | TIPS successfully executes the following checks: <ul style="list-style-type: none"> - RTGS Access Rights Check; - Creditor Account existence; - Currency Check; - LT Amount Check. <p>From now on, the Creditor account indicated in the Liquidity Transfer Order is referred to as "Account to be credited".</p> <p>See 4.1- Business Rules for details.</p> |
| 2e | Receipt (camt.025.001.04) | TIPS as Sender RTGS System as receiver | TIPS unsuccessfully executes one of the checks of step 2 . <p>At the first negative check the system stops and sends a message to the RTGS System – same DN of the Sender – containing the proper error code.</p> <p>The status of the Inbound Liquidity Transfer Order is set to "Failed".</p> |
| 3 | | TIPS | The system selects the Transit Account to be debited from the Transferred Amount as follows: <ul style="list-style-type: none"> - It retrieves from the table "Accounts" the row related to unique Account with type "Transit Account", that in table "Accounts" has the currency equal to the one defined in the Transferred Amount and is open for the current Business Date. <p>From now on, the identified Account is referred to as "Account to be debited".</p> |

| Step | Involved messages | Involved actors | Description |
|------|---|--|--|
| 4 | | TIPS | TIPS successfully completes the execution of the following checks: <ul style="list-style-type: none"> - LT Duplicate Check; - Creditor and Creditor Account not blocked. See 4.1- Business Rules for details. |
| 4e | Receipt (camt.025.001.04) | TIPS as sender RTGS System as receiver | TIPS unsuccessfully executes the check of step 4 . The system stops and sends a message to the RTGS System – same DN of the Sender – containing the proper error code. The status of the Inbound Liquidity Transfer Order is set to "Failed". See 4.1- Business Rules for details. |
| 5 | | TIPS | The instruction is logged and sent to the Check and Execute Instruction process. The status of the Inbound Liquidity Transfer Order is set to "Validated". |
| 6 | | TIPS | TIPS settles the full amount of the Liquidity Transfer Order, debiting the Account to be debited and crediting the Account to be credited. The status of the Inbound Liquidity Transfer is set to "Settled". |
| 7 | Receipt (camt.025.001.04) | TIPS as Sender RTGS System as receiver | The RTGS System is notified by the Output Dispatcher component of the status of the operation. |
| 8 | BankToCustomerDebitCreditNotification | TIPS as sender TIPS Account Owner as receiver | TIPS sends a notification to the TIPS Account owner in order to report the settlement of the liquidity transfer. The message is sent to the default DN of the Account Owner. |
| 9 | ReturnAccount | TIPS as sender TIPS Account owner as receiver | TIPS checks the "Ceiling notification amount" configured for the credited account. If the account balance after settlement is higher than the "Ceiling notification amount", TIPS sends a ReturnAccount to the Account owner. The message is sent to the default DN of the Account Owner. |

2.5.1.1. Examples

This sub-section provides an overview of the Inbound Liquidity Transfers process by describing different examples of the possible scenarios: the first one provides the case where the Liquidity Transfer order is processed smoothly with no rejection by the system and [Bank To Customer Debit Credit Notification](#) message is properly configured by the TIPS Account owner; the second one deals with the rejection of the Liquidity Transfer order due to the failure of the LT Duplicate Check.

The below table summarises, for each reference data object mentioned in the following examples, the related configuration.

Figure 144 – Inbound Liquidity Transfer Order examples: data constellation

| RTGS SYSTEM | | ACTOR | |
|--|--|-----------------------------|--------------|
| RTGS system | T2 | BIC | PRTYABMMXXX |
| Currency | EUR | Type | Participant |
| DN | <ou=dept_123, o=trgtxepmxxx, o=a2anet> | Blocking Status | Unblocked |
| | | Opening Date | 2017-08-16 |
| | | Closing Date | 9999-12-31 |
| PARTY TECHNICAL ADDRESS | | | |
| DN | ACTOR | | |
| <ou=dept_123, o=prtyabmmxxx, o=a2anet> | PRTYABMMXXX | | |
| ACCOUNT | | | |
| Account number | TRANSACC - EUR | Account number | ACCOUNT1 |
| Type | Transit Account | Type | TIPS Account |
| Currency | EUR | Currency | EUR |
| Owner | ECBOEURDXXX | Owner | PRTYABMMXXX |
| Status | Unblocked | Status | Unblocked |
| ... | ... | Credit Notification Flag | True |
| | | Ceiling Notification Amount | 1,800.00 |

2.5.1.1.1 Successful scenario – Inbound Liquidity Transfer order is settled in TIPS

In this scenario:

- The current business date is 27/12/2018 ;
- The RTGS System account owner and the TIPS Account owner are the same entity (PRTYABMMXXX);
- The TIPS Account balance is 1,000.00 EUR;
- The RTGS System sends a [Liquidity Credit Transfer](#) message in order to move liquidity from an RTGS System account (RTGSACCOUNT1) to a TIPS Account (ACCOUNT1);

Figure 145 – Successful Inbound Liquidity Transfer order: liquidity credit transfer



- TIPS receives the request and identifies:
 - o The Account to be credited (ACCOUNT1) from the Creditor Account;
 - o The Transit Account to be debited (TRANSACC – EUR) from the Transferred Amount/Currency;
- TIPS settles the full amount of the Liquidity Transfer Instruction. The Inbound Liquidity Transfer Order is set to *Settled*.

Figure 146 – Successful Inbound Liquidity Transfer order settlement

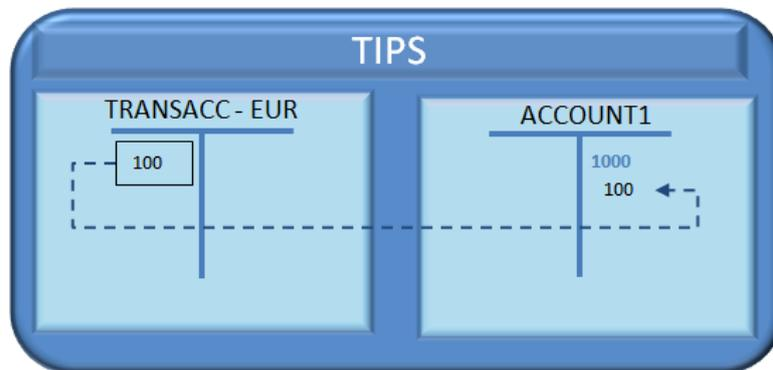

- The [Receipt](#) message is sent by TIPS to the RTGS System – same DN of the sender of the [Liquidity Credit Transfer](#) message – to confirm the execution of the order.

Figure 147 – Successful Inbound Liquidity Transfer order Receipt

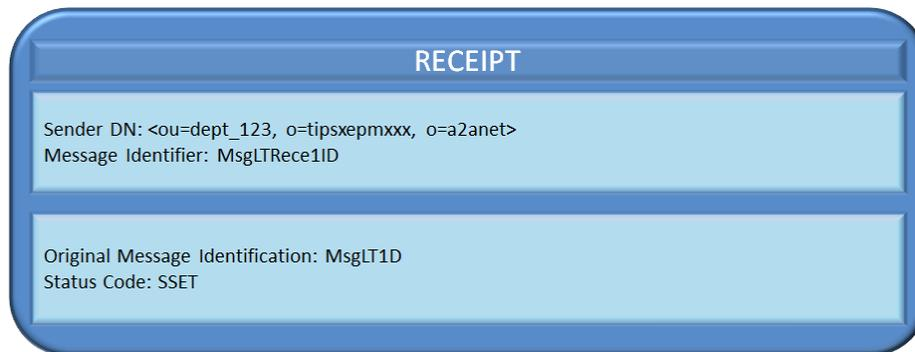

- The system verifies if in table “Accounts”, the Credit Notification Flag related to the Account to be credited is set to “True”; if so, it retrieves the Account Owner DN from the “Routing Configuration” in combination with the “Party Technical Address” (<ou=dept_123, o=prtyabmmxxx, o=a2anet>) to be notified with a positive message ([Bank To Customer Debit Credit Notification](#)) by the Output Dispatcher component.

Figure 148 – Successful Inbound Liquidity Transfer order credit notification

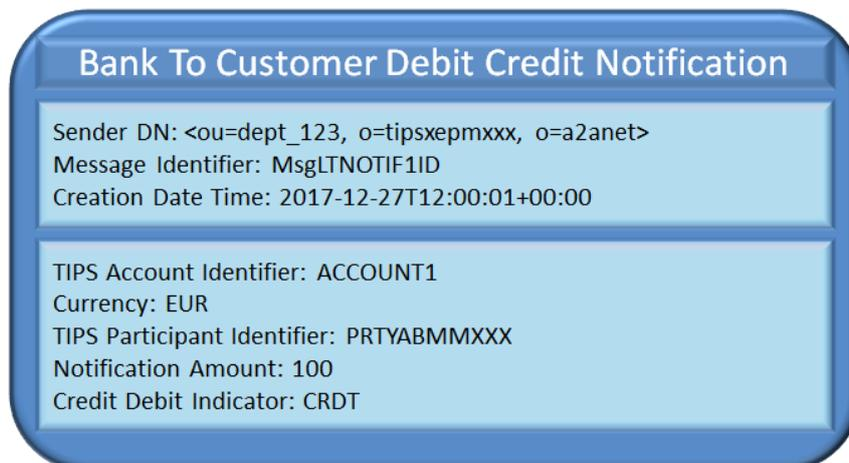

2.5.1.1.2 Unsuccessful scenario: Inbound LT order is rejected because LT duplicate check failed

In this scenario:

- The current business date is 27/12/2018;
- The RTGS System account owner and the TIPS Account owner are the same entity (PRTYABMMXXX);
- The RTGS System sends a [Liquidity Credit Transfer](#) message in order to move liquidity from an RTGS System account (RTGSACCOUNT1) to a TIPS Account (ACCOUNT1);

Figure 149 – Unsuccessful Inbound Liquidity Transfer order: Liquidity credit transfer



- TIPS receives the message and identifies:
 - o The Account to be credited (ACCOUNT1) from the Creditor Account;
 - o The Transit Account to be debited (TRANSACC – EUR) from the Transferred Amount/Currency;
- TIPS detects a duplicate submission: the Liquidity Credit Transfer message has the same Instruction Identification (LT1ID) and Debtor (PRTYABMMXXX) as another Liquidity Credit Transfer message received from the same RTGS System in the last X days (where X is equal to the system parameter "[Retention Period](#)").

Figure 150 – Unsuccessful Inbound Liquidity Transfer order: duplicate submission

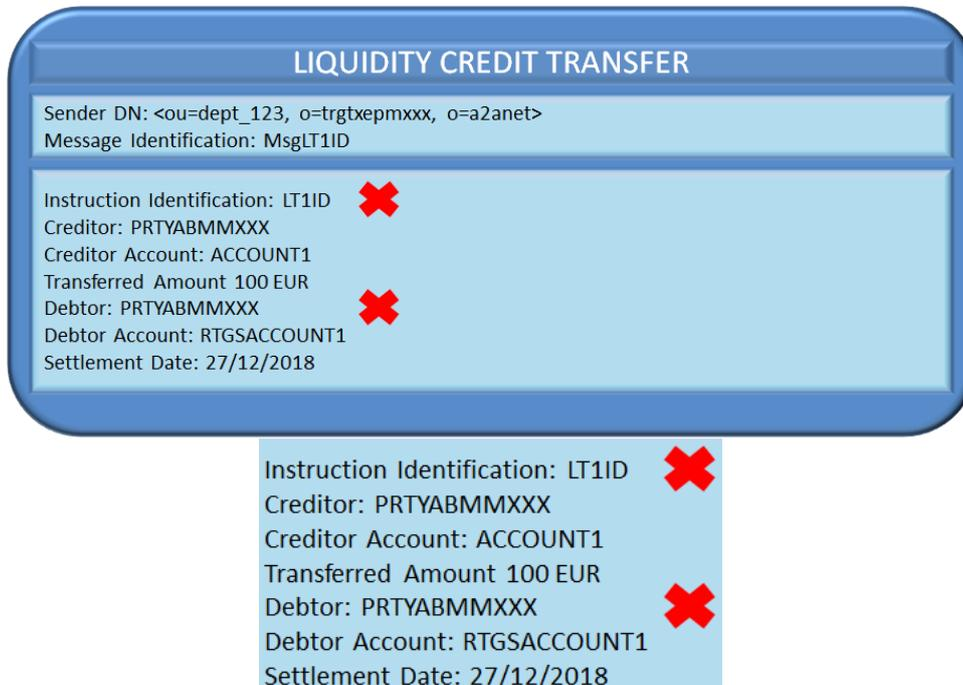

- The following Receipt message is sent by TIPS to the RTGS System to reject the Liquidity Transfer order.

Figure 151 – Unsuccessful Inbound Liquidity Transfer order Receipt

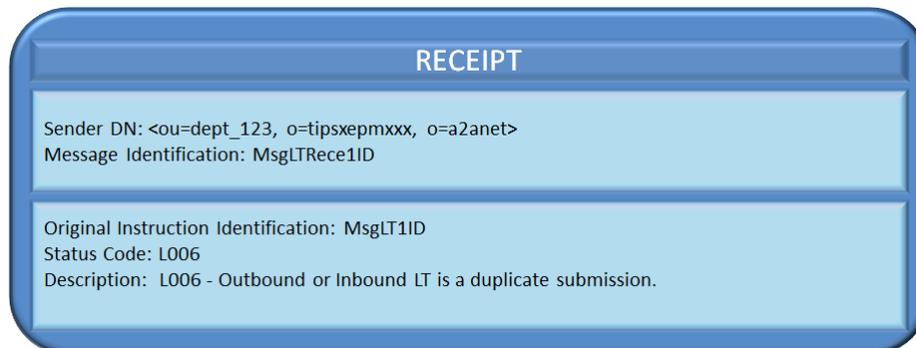

2.5.2. Outbound Liquidity Transfer

This section describes the processing of a Liquidity Transfer order sent by a Participant or Instructing Party acting on behalf of the Participant in order to transfer liquidity from a TIPS Account to an RTGS System account.

Dedicated sub-sections are included with the aim to provide some examples and to illustrate the scenario in which the system notifies to the TIPS Operator about a missing answer from the RTGS System.

The following Actors are involved in the outbound liquidity transfer business process:

- The Central Bank, the TIPS Participant or Instructing Party as instructor of the Liquidity Transfer;
- TIPS that receives and confirms the request from the instructor;
- The RTGS System that receives and confirms the request from TIPS.
- TIPS Account owner (or the default DN configured as receiver) which is duly informed if the account balance goes below the configured threshold. Additionally, if they subscribed to the debit notification, they will receive a debit notification after successful settlement confirmation from the RTGS System.

The following messages are involved in the Outbound Liquidity Transfer business process:

- [Liquidity Credit Transfer](#): the message which enables the sender to instruct the transfer liquidity from the TIPS Account to an RTGS System account;
- [Receipt \(camt.025.001.05\)](#): the message sent by TIPS to the TIPS Participant or Instructing Party to confirm/reject the execution of a Liquidity Transfer;
- [Receipt \(camt.025.001.04\)](#): the message sent by the RTGS System to confirm/reject the execution of a Liquidity Transfer;

- [BankToCustomerDebitCreditNotification](#): the message sent by TIPS to report the settlement of a Liquidity Transfer to the TIPS Account owner (or the default DN configured as receiver). The notification is sent out only if previously configured by the account owner.
- [ReturnAccount](#): the message sent by TIPS to notify the owner of the debited TIPS Account that the floor threshold is exceeded. The notification is generated for the account owner only if the floor threshold is configured.

Central Banks shall be able to initiate an Outbound Liquidity Transfer even if the closing date of the TIPS Account is exceeded and regardless of the TIPS Account's blocking status.

The process described below is triggered under the assumption that the technical validation, check of mandatory fields and authentication of the user has been already successfully performed by ESMIG. The following diagram describes the Outbound Liquidity business process.

Figure 152 – Outbound Liquidity Transfer Order flow

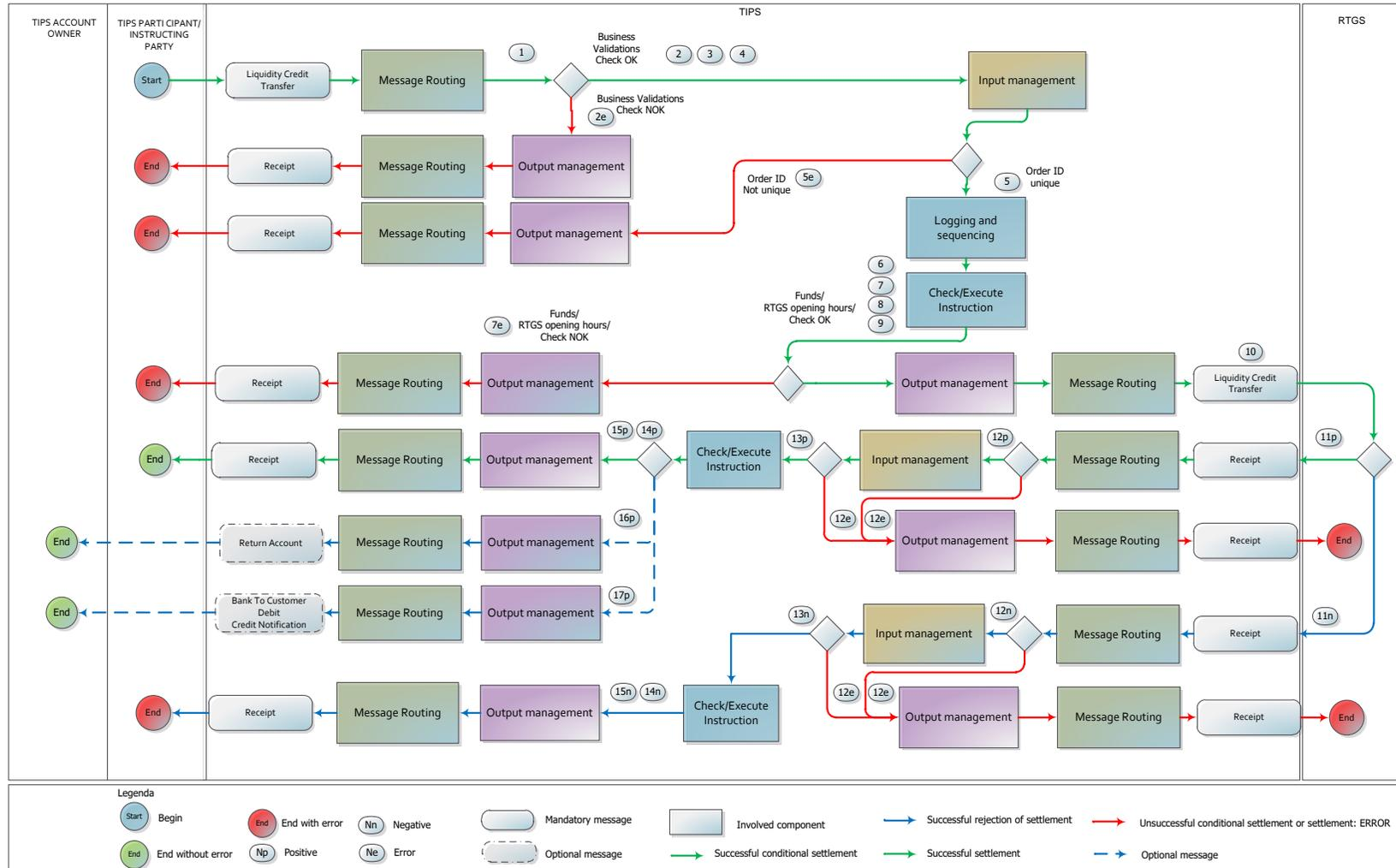

The table below describes each single step of the Outbound Liquidity Transfer process.

Table 64 – Outbound Liquidity Transfer Order steps

| Step | Involved messages | Involved actors | Description |
|------|---|---|---|
| 1 | LiquidityCreditTransfer | TIPS Participant or Instructing Party as sender TIPS as receiver | TIPS receives an Outbound Liquidity transfer request from the TIPS Participant or Instructing Party. Technical validation, check of mandatory fields and authentication checks have already been successfully executed by ESMIG. |
| 2 | | TIPS | TIPS successfully executes the following checks: <ul style="list-style-type: none"> - Access Rights check; - Debtor Account existence; - Currency Check; - Instructing Party authorised; - LT Amount Check. <p>See 4.1- Business Rules for details.</p> |
| 2e | Receipt (camt.025.001.05) | TIPS as sender TIPS Participant or Instructing Party as receiver | TIPS unsuccessfully executes one of the checks of step 2 . At the first negative check the system stops and sends a message to the TIPS Participant or Instructing Party – same DN of the sender – containing the proper error code. The status of the Outbound Liquidity Transfer Order is set to “ <i>Failed</i> ”. |
| 3 | | TIPS | From now on, the debit account indicated in the Liquidity Transfer Order, is referred to as “Account to be debited”. |

| Step | Involved messages | Involved actors | Description |
|------|---|---|---|
| 4 | | TIPS | <p>TIPS identifies the RTGS System and the RTGS System Transit Account to be credited based on the currency of the Liquidity Transfer Order.</p> <p>In details:</p> <ul style="list-style-type: none"> - the system selects from table "RTGS Systems" the RTGS System which has the currency equal to the Transferred Amount currency. <p>From now on, the identified RTGS System is referred to as "RTGS System".</p> <ul style="list-style-type: none"> - the system selects from table "Accounts" an account, type "Transit Account", that has the currency equal to the Transferred Amount currency. <p>From now on, the identified account is referred to as "Account to be credited";</p> |
| 5 | | TIPS | <p>TIPS successfully completes the execution of the following check:</p> <ul style="list-style-type: none"> - LT Duplicate Check; - Debtor and Debtor Account not blocked. <p>See 4.1- Business Rules for details.</p> |
| 5e | Receipt (camt.025.001.05) | TIPS as sender TIPS Participant or Instructing Party as receiver | <p>TIPS unsuccessfully executes the check indicated in step 5.</p> <p>The system stops and sends a message to the TIPS Participant or Instructing Party – same DN of the sender – containing the proper error code.</p> <p>The status of the Outbound Liquidity Transfer Order is set to "Failed".</p> <p>See 4.1- Business Rules for details.</p> |
| 6 | | TIPS | <p>The order is logged and sent to the Check and Execute Instruction process.</p> <p>The status of the Outbound Liquidity Transfer Order is set to "Validated".</p> |

| Step | Involved messages | Involved actors | Description |
|------|---|---|---|
| 7 | | TIPS | TIPS successfully completes the execution of the following checks: <ul style="list-style-type: none"> - RTGS opening hours Check; - RTGS partial closure Check; - Funds Check. <p>See 4.1- Business Rules for details.</p> |
| 7e | Receipt (camt.025.001.05) | TIPS as sender TIPS Participant or Instructing Party as receiver | TIPS unsuccessfully executes one of the checks of step 7 . At the first negative check the system stops and sends a message to the TIPS Participant or Instructing Party – same DN of the sender – containing the proper error code. The status of the Outbound Liquidity Transfer Order is set to “ <i>Failed</i> ”. |
| 8 | | TIPS | The DN of the sender in step 1 is saved as information related to the transaction. From now on, this DN is referred to as “Debtor DN”. |
| 9 | | TIPS | TIPS settles the full amount of the Liquidity Transfer Instruction, crediting the Account to be credited and debiting the Account to be debited. The status of the Outbound Liquidity Transfer Order is set to “ <i>Transient</i> ”. |
| 10 | LiquidityCreditTransfer | TIPS as sender RTGS System as receiver | The TIPS Output dispatcher forwards, through the Message Router, the received Liquidity transfer request to the RTGS System DN. TIPS remains waiting for a RTGS System Reply. The scenario where the RTGS System’s reply is not received after a configurable timeframe (RTGS Alert) is described in section 2.5.2.2 “RTGS Alert scenario – No reply from RTGS” . |
| 11p | Receipt (camt.025.001.04) | RTGS System as sender TIPS as receiver | TIPS receives a Receipt message sent from the RTGS System in order to confirm the transfer; |
| 12p | | TIPS | The TIPS Message Router successfully completes the execution of the following check: <ul style="list-style-type: none"> - RTGS Access Rights Check. <p>See 4.1- Business Rules for details.</p> |

| Step | Involved messages | Involved actors | Description |
|------|---|---|---|
| 13p | | TIPS | The Input Collector successfully performs the following checks: <ul style="list-style-type: none"> - Invalid status code in RTGS Answer Check; - Pending (Transient) order existing. See 4.1- Business Rules for details. |
| 14p | | TIPS | The status of the Outbound Liquidity Transfer Order is set to "Settled". |
| 15p | Receipt (camt.025.001.05) | TIPS as sender TIPS Participant or Instructing Party as receiver | The TIPS Output Dispatcher translates and forwards to the "Debtor DN", through the Message Router, the Receipt message received from the RTGS System. |
| 16p | ReturnAccount | TIPS as sender TIPS Account owner as receiver | Once the status of the Outbound Liquidity Transfer Order is set to "Settled", TIPS checks the "Floor notification amount" configured for the involved Account to be debited. If the account balance is lower than the "floor notification amount", TIPS sends a ReturnAccount to the Account owner (or the default DN configured as receiver) involved in the transaction. |
| 17p | BankToCustomerDebitCreditNotification | TIPS as sender TIPS Account Owner as receiver | TIPS sends a notification to the TIPS Account owner in order to report the settlement of the liquidity transfer. |
| 12e | Receipt (camt.025.001.04) | TIPS as sender RTGS System as receiver | TIPS unsuccessfully executes the checks included in steps 12p/13p or 12n/13n . The system stops and sends a message to the RTGS System – containing the proper error code. In the first scenario, if the rejected message was a positive receipt being sent at step 11p , the RTGS System can send a new positive receipt triggering the restart of the processing from step 11p . In the second scenario, if the rejected message was a negative receipt being sent at step 11n , the RTGS System can send a new negative receipt triggering the restart of the processing from step 11n . |
| 11n | Receipt (camt.025.001.04) | RTGS System as sender TIPS as receiver | TIPS receives a Receipt message sent from the RTGS System in order to reject the transfer; |

| Step | Involved messages | Involved actors | Description |
|------|---|---|---|
| 12n | | TIPS | TIPS successfully completes the execution of the following check: - RTGS Access Rights Check . See 4.1- Business Rules for details. |
| 13n | | TIPS | The Input Collector successfully performs the following checks: - Invalid status code in RTGS Answer Check ; - Pending (Transient) order existing . See 4.1- Business Rules for details. |
| 14n | | TIPS | TIPS performs an automatic reverse of funds from the original Account to be credited and the original Account to be debited. The transaction is set to " <i>Rejected</i> " status. |
| 15n | Receipt (camt.025.001.05) | TIPS as sender TIPS Participant or Instructing Party as receiver | The TIPS Output Dispatcher forwards to the "Debtor DN", through the Message Router, the Receipt message received from the RTGS System. |

2.5.2.1. Examples

This sub-section presents different examples related to the Outbound Liquidity Transfer process. The first one describes the successful scenario where the Liquidity Transfer order is processed smoothly; the second and third ones deal with the rejection of the Liquidity Transfer order by TIPS for insufficient funds and by the RTGS System, respectively.

The below table summarises, for each reference data object mentioned in the following examples, the related configuration.

Figure 153 – Outbound Liquidity Transfer Order examples: data constellation

| RTGS SYSTEM | | ACTOR | |
|-------------------------|--|-----------------------------|--------------|
| RTGS system | T2 | BIC | PRTYABMMXXX |
| Currency | EUR | Type | Participant |
| DN | <ou=dept_123, o=trgtxepmxxx, o=a2anet> | Blocking Status | Unblocked |
| | | Opening Date | 2017-08-16 |
| | | Closing Date | 9999-12-31 |
| PARTY TECHNICAL ADDRESS | | | |
| DN | <ou=dept_123, o=prtyabmmxxx, o=a2anet> | ACTOR | PRTYABMMXXX |
| | | | |
| ACCOUNT | | | |
| Account number | TRANSACC - EUR | Account number | ACCOUNT1 |
| Type | Transit Account | Type | TIPS Account |
| Currency | EUR | Currency | EUR |
| Owner | ECBOEURDXXX | Owner | PRTYABMMXXX |
| Status | Unblocked | Status | Unblocked |
| ... | ... | Credit Notification Flag | True |
| | | Debit Notification Flag | True |
| | | Ceiling Notification Amount | 1,800.00 |

2.5.2.1.1 Successful scenario – Outbound LT order settled in TIPS and RTGS System

In this scenario:

- The current business date is 27/12/2018;
- A TIPS Participant sends a Liquidity Transfer request in order to move liquidity from the TIPS Account (ACCOUNT1) to an RTGS System account (RTGSACCOUNT1);

Figure 154 – Successful Outbound Liquidity Transfer order: Liquidity Credit Transfer



- TIPS identifies:
 - o The DN of sender – i.e. the TIPS Participant or Instructing Party (<ou=dept_123, o=prtyabmmxxx, o=a2anet>);
 - o The RTGS System and the related DN (<ou=dept_123, o=trgtxepmxxx, o=a2anet>) from the Transferred Amount/Currency;
 - o The Transit Account to be credited (TRANSACC – EUR) from the Transferred Amount/Currency;
 - o The Debtor (PRTYABMMXXX)
 - o The Account to be debited (ACCOUNT1) from the Debtor Account;
- The status of the Outbound Liquidity Transfer Order is set to *Validated*.
- TIPS settles the full amount of the Liquidity Transfer Instruction. The Outbound Liquidity Transfer Order is set to *Transient*.

Figure 155 – Successful Outbound Liquidity Transfer order settlement

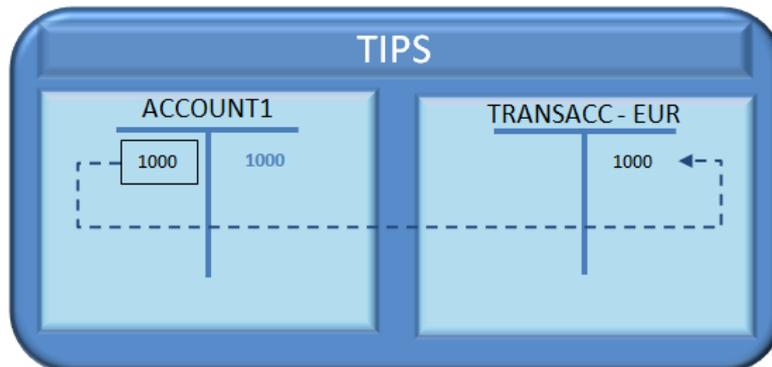

- The Liquidity Transfer request is forwarded to the interested RTGS System for the related settlement.

Figure 156 – Successful Outbound Liquidity Transfer order: Liquidity Credit Transfer

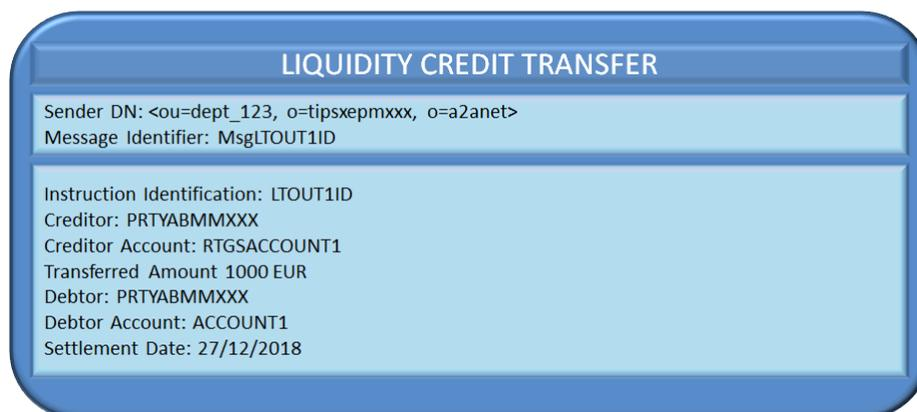

- The following Receipt message is sent by the RTGS System to TIPS to confirm the execution of the liquidity transfer. The status of the Outbound Liquidity Transfer Order is set to *Settled*.

Figure 157 – Successful Outbound Liquidity Transfer order Receipt received by TIPS

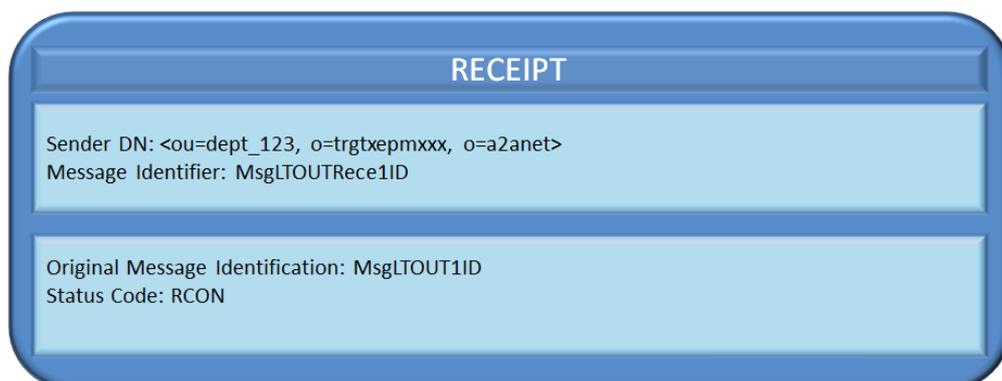

- The TIPS Participant or Instructing Party is notified by the Output Dispatcher component with a positive message ([Receipt](#)).

Figure 158 – Successful Outbound Liquidity Transfer order Receipt sent by TIPS

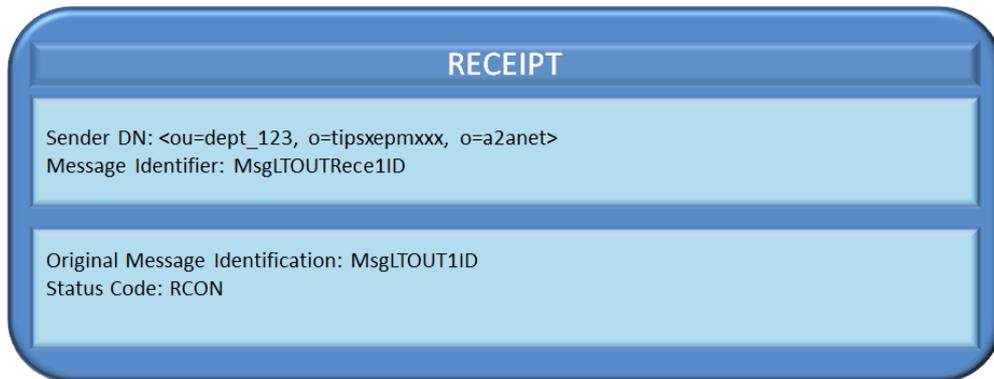

- The system verifies if in table “Accounts”, the Debit Notification Flag related to the Account to be debited is set to “True”; if so, it retrieves the Account Owner DN from the “Routing Configuration” in combination with the “Party Technical Address” (<ou=dept_123, o=prtyabmmxxx, o=a2anet>) to be notified with a positive message ([Bank To Customer Debit Credit Notification](#)) by the Output Dispatcher component.

Figure 159 – Successful Outbound Liquidity Transfer order debit notification



2.5.2.1.2 Unsuccessful scenario – Outbound LT order rejected for insufficient funds in TIPS

In this scenario:

- The current business date is 27/12/2018;
- The TIPS Account balance is 150.00 EUR;
- A TIPS Participant sends a Liquidity Transfer request in order to move liquidity from the TIPS Account (ACCOUNT1) to an RTGS System account (RTGSACCOUNT1);

Figure 160 – Unsuccessful Outbound Liquidity Transfer order: Liquidity Credit Transfer



- The message router component processes the incoming request and performs the relevant checks related to the authorisations of the sending party and several business validations.
- The system identifies:
 - o The DN of the sender – i.e. the TIPS Participant or Instructing Party (<ou=dept_123, o=prtyabmmxxx, o=a2anet>);
 - o The RTGS System and the related DN (<ou=dept_123, o=trgtxepmxxx, o=a2anet>) from the Transferred Amount/Currency;
 - o The Transit Account to be credited (TRANSACC – EUR) from the Transferred Amount/Currency;
 - o The Debtor (PRTYABMMXXX)
 - o The Account to be debited (ACCOUNT1) from the Debtor Account.
- The system detects that the resources available on the cash balance involved in the settlement under process, are insufficient.
- The status of the Outbound Liquidity Transfer Order is set to *Failed* and a Receipt message is sent by TIPS in order to inform the TIPS Participant.

Figure 161 – Unsuccessful Outbound Liquidity Transfer order Receipt sent by TIPS

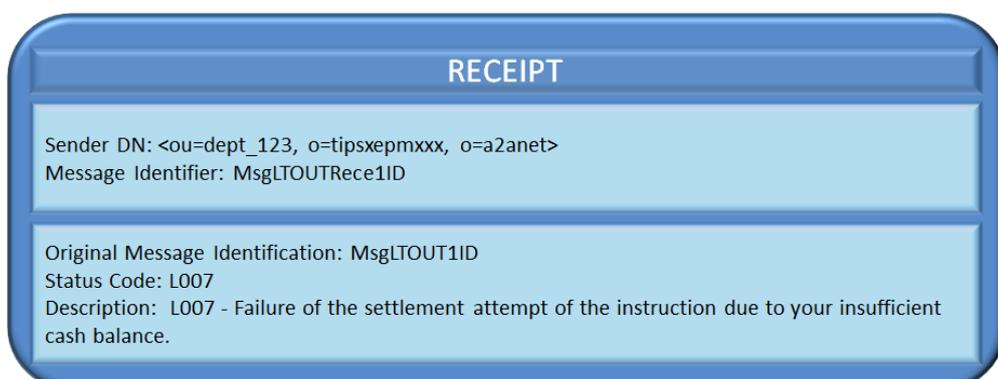

2.5.2.1.3 Unsuccessful scenario – Outbound LT order rejected by the RTGS System

In this scenario:

- The current business date is 27/12/2018;
- A TIPS Participant sends a Liquidity transfer request in order to move liquidity from the TIPS Account (ACCOUNT1) to an RTGS System account (RTGSACCOUNT1).

Figure 162 – Outbound Liquidity Transfer order: incoming message



- TIPS receives the message and identifies:
 - o The DN of the sender – i.e. the TIPS Participant or Instructing Party (<ou=dept_123, o=prtyabmmxxx, o=a2anet>);
 - o The RTGS System and the related DN (<ou=dept_123, o=trgtxepmxxx, o=a2anet>) from the Transferred Amount/Currency;
 - o The Transit Account to be credited (TRANSACC – EUR) from the couple Transferred Amount and Currency;
 - o The Debtor (PRTYABMMXXX);
 - o The Account to be debited (ACCOUNT1) from the Debtor Account.
- The status of the Outbound Liquidity Transfer Order is set to *Validated*;
- TIPS settles the full amount of the Liquidity Transfer Order by debiting the Account to be debited (ACCOUNT1) and crediting the Transit Account (TRANSACC – EUR). The Outbound Liquidity Transfer Order is set to *Transient*.

Figure 163 – Outbound Liquidity Transfer order: settlement in TIPS

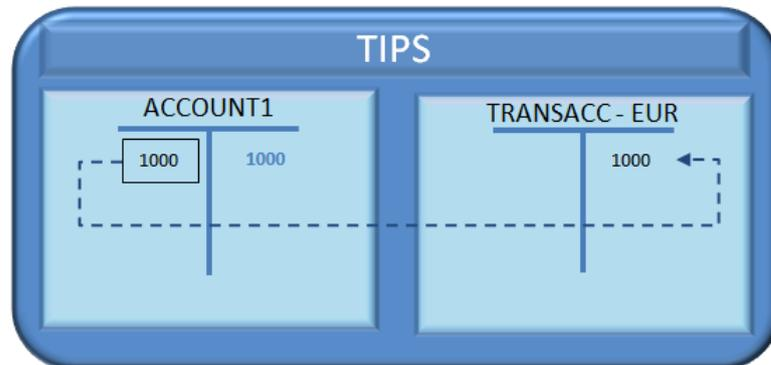

- The Liquidity transfer request is forwarded to the pertinent RTGS System for the settlement in the related currency.

Figure 164 – Outbound Liquidity Transfer order: forwarding to the RTGS System

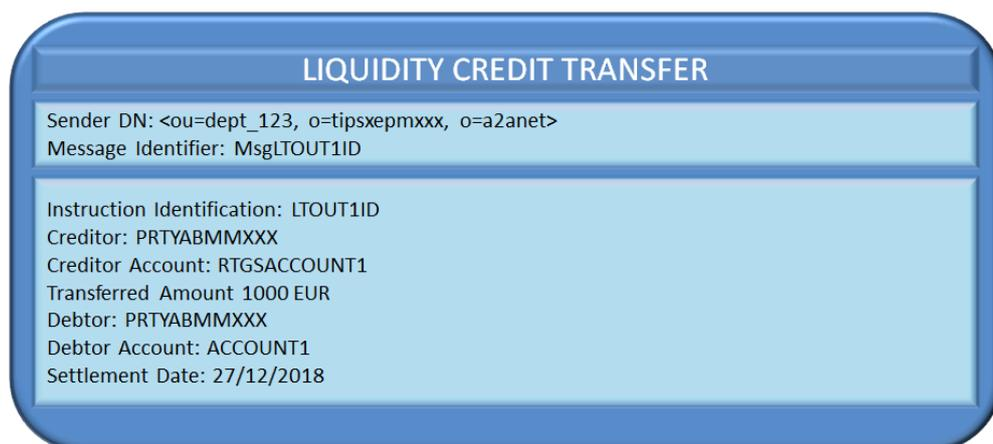

- The following Receipt message is sent by the RTGS System to TIPS to reject liquidity transfer order.

Figure 165 – Outbound Liquidity Transfer order: negative Receipt sent by the RTGS System



- TIPS performs an automatic reverse of funds from the RTGS System Transit Account to the TIPS Account originally debited.

Figure 166 – Outbound Liquidity Transfer order: reverse settlement

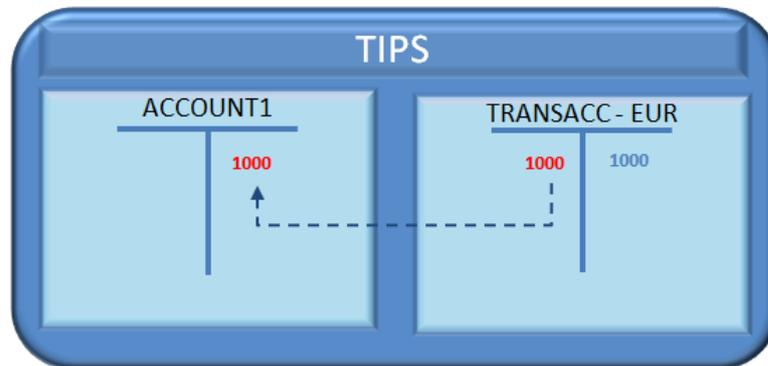

- The status of the Outbound Liquidity Transfer Order is set to *Rejected* and a Receipt message is sent by TIPS in order to inform the TIPS Participant.

Figure 167 – Outbound Liquidity Transfer order: negative Receipt sent by TIPS

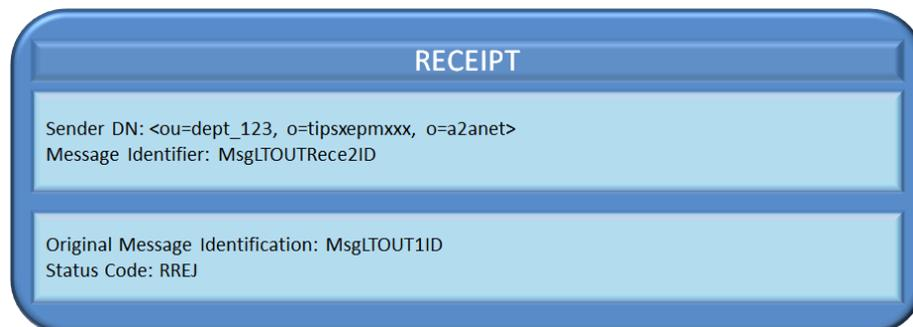

2.5.2.2. RTGS Alert scenario – No reply from RTGS System

TIPS Participants can initiate outbound Liquidity transfers in TIPS using a Liquidity Transfer Order message. After having performed the necessary validations, TIPS transfers the requested amount from the TIPS Account to the Transit Account. Thereafter, TIPS forwards the liquidity transfer to the corresponding RTGS System and waits for an answer. The RTGS System is expected to reply with either a confirmation or a rejection message within a configurable timeframe.

A specific software component is always acting in background detecting Liquidity Transfer Orders whose status is *Transient* and for which the lapse of time between the time the order is received in TIPS and the current timestamp is longer than X minutes (X being the “[RTGS Alert](#)” system parameter, see [1.7 “Service configuration”](#)).

In case the RTGS System does not provide any suitable answer within the aforementioned timeframe, TIPS alerts the TIPS Operator who can then initiate an appropriate operational procedure (depending on the reason for the timeout and the current status of TIPS and the RTGS System).

The following diagram illustrates the process where the Liquidity Transfer Order is successfully processed and forwarded by TIPS to the RTGS System but no proper RTGS System answer is received within the configured time window.

Figure 168 – Outbound Liquidity Transfer: Missing RTGS System answer flow

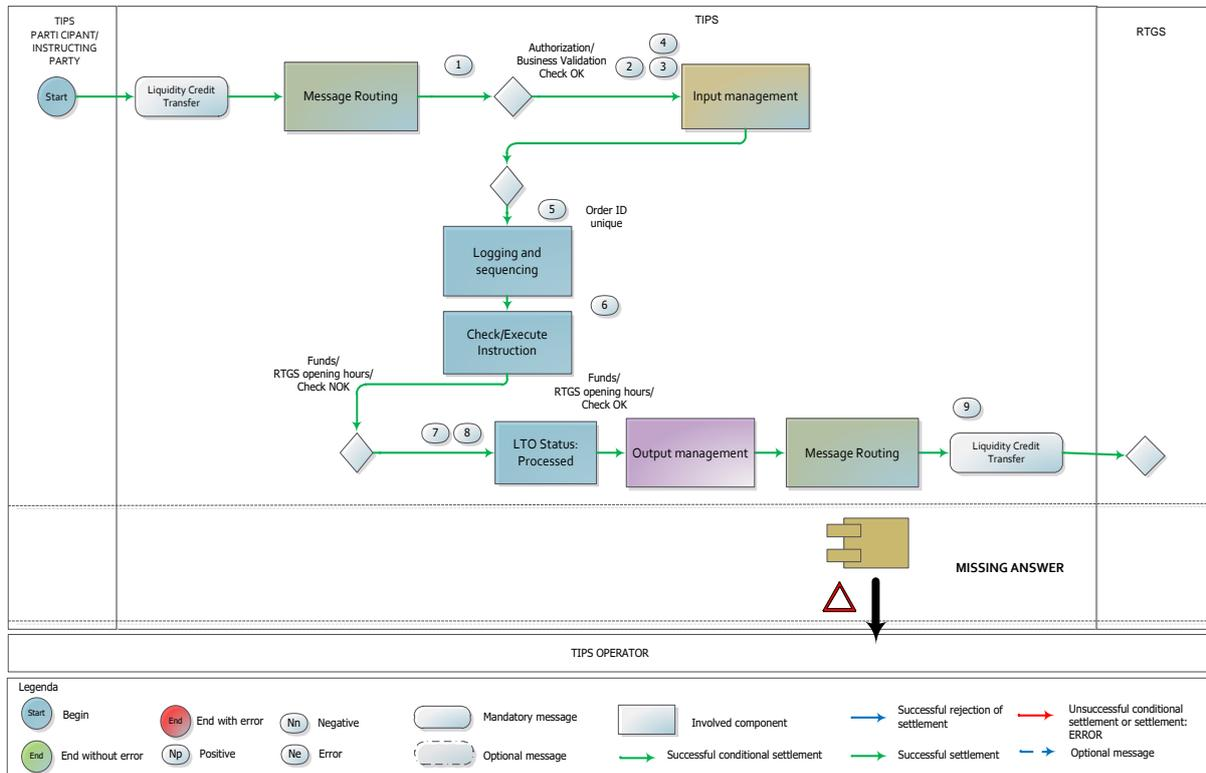

All the single steps from 1 to 10 are described in [Table 64 – Outbound Liquidity Transfer Order steps](#). The remaining steps are described in [Table 65 – Outbound Liquidity Transfer: Missing RTGS answer steps](#) below.

Table 65 – Outbound Liquidity Transfer: Missing RTGS answer steps

| Step | Involved messages | Involved actors | Description |
|------|-------------------|-----------------|--|
| 11 | | TIPS | The specified period of time configured as RTGS Alert has elapsed since the Liquidity Transfer request has been received by TIPS from the TIPS Participant (step 1) and neither a confirmation nor a rejection has been received from the RTGS System. TIPS raises an alert to the TIPS Operator. |
| 12 | | TIPS Operator | Operational procedures are put in place in order to either confirm the Liquidity Transfer and inform the Instructing Party, or move back the liquidity from the RTGS Transit Account to the TIPS Participant Account. |

2.5.3. Intra-service Liquidity Transfer

This section describes the processing of an Intra-service Liquidity Transfer order sent by a TIPS Participant, Ancillary System or Instructing Party acting on behalf of the TIPS Participant or a Reachable Party in order to transfer liquidity from a TIPS Account to a TIPS AS Technical Account (or vice versa).

The following Actors are involved in the intra-service liquidity transfer business process:

- The Central Bank, TIPS Participant, Ancillary System or Instructing Party as sender of the Liquidity Transfer;
- TIPS that receives and confirms the request from the sender;
- The TIPS Account or TIPS AS Technical Account owner (or the default DN configured as receiver) which is duly informed if the account balance goes above or below the configured thresholds. Additionally, upon subscription in CRDM, they will receive a debit or credit notification after successful settlement.

The following messages are involved in the Intra-service Liquidity Transfer business process:

- [Liquidity Credit Transfer](#): the message which enables the sender to transfer liquidity from the TIPS Account to a TIPS AS Technical account (or vice versa);
- [Receipt \(camt.025.001.05\)](#): the message sent by TIPS to the TIPS Participant, Ancillary System or Instructing Party to confirm/reject the execution of an intra-service Liquidity Transfer;
- [BankToCustomerDebitCreditNotification](#): the message sent by TIPS to report the settlement of a Liquidity Transfer to the account owner (or the default DN configured as receiver). The notification is sent out only if previously subscribed by the Account owner.
- [ReturnAccount](#): the message sent by TIPS to notify the owner of the debited (or credited) account that the floor (or ceiling) threshold is breached. The notifications are generated and sent to the Account owner only if the floor/ceiling thresholds have been configured for each account involved in the liquidity transfer.

Central Banks shall be able to initiate an Intra-service Liquidity Transfer even if the closing date of the account is exceeded and regardless of the account's blocking status.

The process described below is triggered under the assumption that the technical validation, check of mandatory fields and authentication of the user has been already successfully performed by ESMIG. The following diagram describes the Intra-service Liquidity Transfer business process.

Figure 169 – Intra-service Liquidity Transfer diagram

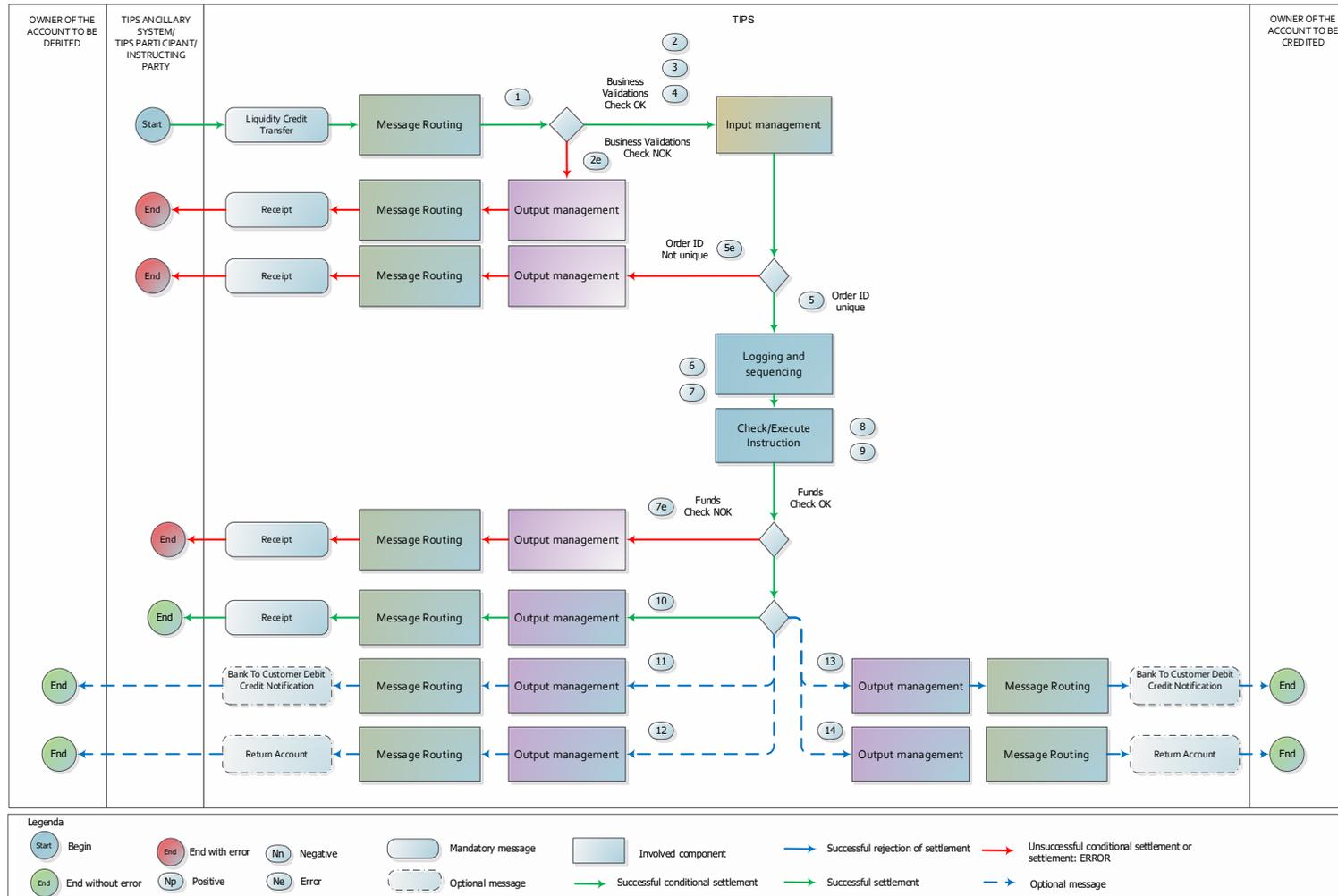

The table below describes each single step of the Intra-service Liquidity Transfer process.

Table 66 – Intra-service Liquidity Transfer steps

| Step | Involved messages | Involved actors | Description |
|------|---|---|--|
| 1 | LiquidityCreditTransfer | TIPS Participant, Ancillary system or Instructing Party as sender TIPS as receiver | TIPS receives an Intra-service Liquidity transfer request from the TIPS Participant, Ancillary System or Instructing Party. Technical validation, check of mandatory fields and authentication checks have already been successfully executed by ESMIG. |
| 2 | | TIPS | TIPS successfully executes the following checks: <ul style="list-style-type: none"> - Access Rights check; - Intra-service LT check; - Currency Check; - Instructing Party authorised; - LT Amount Check. See 4.1- Business Rules for details. |
| 2e | Receipt (camt.025.001.05) | TIPS as sender TIPS Participant, Ancillary system or Instructing Party as receiver | TIPS unsuccessfully executes one of the checks of step 2 . At the first negative check the system stops and sends a message to the TIPS Participant, Ancillary system or Instructing Party – same DN of the sender – containing the proper error code. The status of the Intra-service Liquidity Transfer Order is set to “Failed”. |
| 3 | | TIPS | From now on, the debited account indicated in the Liquidity Transfer Order, is referred to as "Account to be debited". |
| 4 | | TIPS | From now on, the credited account indicated in the Liquidity Transfer Order, is referred to as "Account to be credited". |

| Step | Involved messages | Involved actors | Description |
|------|---|--|--|
| 5 | | TIPS | <p>TIPS successfully completes the execution of the following check:</p> <ul style="list-style-type: none"> - LT Duplicate Check; - Debtor and Debtor Account not blocked. - Creditor and Creditor Account not blocked <p>See 4.1- Business Rules for details.</p> |
| 5e | Receipt (camt.025.001.05) | <p>TIPS as sender</p> <p>TIPS Participant, Ancillary system or Instructing Party as receiver</p> | <p>TIPS unsuccessfully executes the checks indicated in step 5. The system stops and sends a message to the TIPS Participant, Ancillary system or Instructing Party – same DN of the sender – containing the proper error code.</p> <p>The status of the Intra-service Liquidity Transfer Order is set to "Failed".</p> <p>See 4.1- Business Rules for details.</p> |
| 6 | | TIPS | <p>The order is logged and sent to the Check and Execute Instruction process.</p> <p>The status of the Intra-service Liquidity Transfer Order is set to "Validated".</p> |
| 7 | | TIPS | <p>TIPS successfully completes the execution of the following check:</p> <ul style="list-style-type: none"> - Funds Check. <p>See 4.1- Business Rules for details.</p> |
| 7e | Receipt (camt.025.001.05) | <p>TIPS as sender</p> <p>TIPS Participant, Ancillary system or Instructing Party as receiver</p> | <p>TIPS unsuccessfully executes the check of step 7. The system stops and sends a message to the TIPS Participant, Ancillary system or Instructing Party – same DN of the sender – containing the proper error code.</p> <p>The status of the Intra-service Liquidity Transfer Order is set to "Failed".</p> |
| 8 | | TIPS | <p>The DN of the sender in step 1 is saved as information related to the transaction. From now on, this DN is referred to as "Debtor DN".</p> |

| Step | Involved messages | Involved actors | Description |
|------|---|---|--|
| 9 | | TIPS | TIPS settles the full amount of the Liquidity Transfer Instruction, crediting the account to be credited and debiting the account to be debited. The status of the Intra-service Liquidity Transfer Order is set to "Settled". |
| 10 | Receipt (camt.025.001.05) | TIPS as sender TIPS Participant, Ancillary system or Instructing Party as receiver | The TIPS Output Dispatcher forwards to the "Debtor DN", through the Message Router, the Receipt message. |
| 11 | ReturnAccount | TIPS as sender Owner of the debited account as receiver | Once the status of the Intra-service Liquidity Transfer Order is set to "Settled", TIPS checks the "Floor notification amount" configured for the involved account to be debited. If the account balance is lower than the "Floor notification amount", TIPS sends a ReturnAccount to the account owner (or the default DN configured as receiver) involved in the transaction. |
| 12 | BankToCustomerDebitCreditNotification | TIPS as sender Owner of the debited account as receiver | TIPS sends a notification to the owner of the debited account in order to report the settlement of the liquidity transfer. |
| 13 | ReturnAccount | TIPS as sender Owner of the credited account as receiver | Once the status of the Intra-service Liquidity Transfer Order is set to "Settled", TIPS checks the "Ceiling notification amount" configured for the credited account. If the account balance is higher than the "Ceiling notification amount", TIPS sends a ReturnAccount to the account owner (or the default DN configured as receiver) involved in the transaction. |
| 14 | BankToCustomerDebitCreditNotification | TIPS as sender Owner of the credited account as receiver | TIPS sends a notification to the owner of the credited account in order to report the settlement of the liquidity transfer. |

2.5.3.1. Examples

This sub-section presents different examples related to the Intra-service Liquidity Transfer process. The first one describes the successful scenario where the Liquidity Transfer order is processed smoothly; the second deals with the rejection of the Liquidity Transfer order by TIPS for insufficient funds.

The below table summarises, for each reference data object mentioned in the following examples, the related configuration.

Figure 170 – Intra-service Liquidity Transfer examples: data constellation

| RTGS SYSTEM | | ACTOR | |
|-------------|--|-----------------|------------------|
| RTGS system | T2 | BIC | PRTYABMMXXX |
| Currency | EUR | Type | Participant |
| DN | <ou=dept_123, o=trgtxepmxxx, o=a2anet> | Blocking Status | Unblocked |
| | | Opening Date | 2017-08-16 |
| | | Closing Date | 9999-12-31 |
| | | BIC | ACH1ASMMXXX |
| | | Type | Ancillary System |
| | | Blocking Status | Unblocked |
| | | Opening Date | 2021-11-20 |
| | | Closing Date | 9999-12-31 |

| PARTY TECHNICAL ADDRESS | |
|--|-------------|
| DN | ACTOR |
| <ou=dept_123, o=prtyabmmxxx, o=a2anet> | PRTYABMMXXX |
| <ou=ACH, o=prtyasmxxx, o=a2anet> | ACH1ASMMXXX |

| ACCOUNT | | | |
|-----------------------------|--------------|-----------------------------|-------------------|
| Account number | ACCOUNT1 | Account number | TECASACC1 |
| Type | TIPS Account | Type | TIPS AS Tech.Acc. |
| Currency | EUR | Currency | EUR |
| Owner | PRTYABMMXXX | Owner | ACH1ASMMXXX |
| Status | Unblocked | Status | Unblocked |
| Credit Notification Flag | True | Credit Notification Flag | True |
| Debit Notification Flag | True | Debit Notification Flag | True |
| Ceiling Notification Amount | 1,800.00 | Ceiling Notification Amount | 1,000,000.00 |

2.5.3.1.1 Successful scenario – Intra-service LT successfully settled

In this scenario:

- The current business date is 22/11/2021;
- A TIPS Participant (PRTYABMMXXX) sends an intra-system Liquidity Transfer request to move liquidity from its TIPS Account (ACCOUNT1) to a TIPS AS Technical Account (TECASACC1) owned by an Ancillary System (ACH1ASMMXXX);
- The transfer of liquidity is done by the TIPS Participant on behalf of a reachable party (RECPARMMXXX) previously authorised to settle on the TIPS AS Technical Account

Figure 171 – Successful intra-service Liquidity Transfer: LiquidityCreditTransfer



- TIPS identifies:
 - o The DN of sender – i.e. the TIPS Participant or Instructing Party (<ou=dept_123, o=prtyabmmxxx, o=a2anet>);
 - o The Debtor (PRTYABMMXXX);
 - o The TIPS Account to be debited (ACCOUNT1) from the Debtor Account;
 - o The TIPS Account balance is equal to 150,000.00 EUR
 - o The TIPS AS Technical Account to be credited (TECASACC1) from the Creditor Account;
- The status of the intra-service Liquidity Transfer Order is set to *Validated*.
- TIPS settles the full amount of the Liquidity Transfer Instruction. The intra-service Liquidity Transfer Order is set to *Settled*.

Figure 172 – Successful intra-system Liquidity Transfer settlement

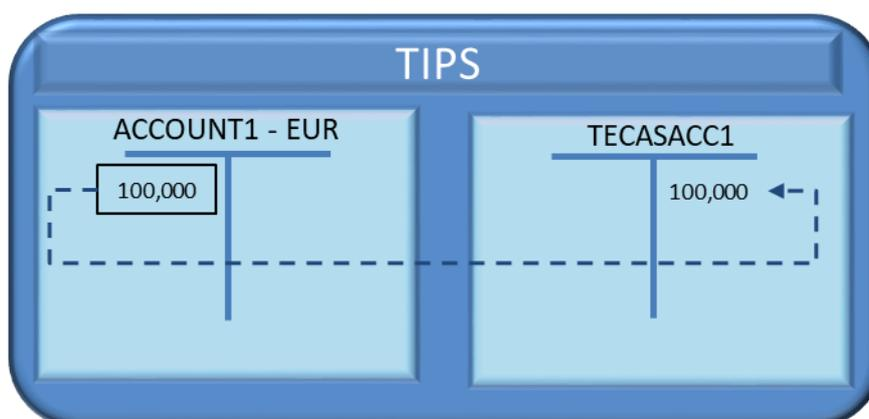

- The following Receipt message is sent by TIPS to the sender of the intra-service LT to confirm the settlement.

Figure 173 – Positive intra-service Liquidity Transfer: Receipt



- The TIPS Participant or Instructing Party is notified by the Output Dispatcher component with a positive [Receipt \(camt.025.001.05\)](#) message;
- TIPS checks whether the Debit Notification Flag related to the TIPS Account to be debited is set to “True”; if so, it retrieves the Account Owner DN from the “Routing Configuration” in combination with the “Party Technical Address” (<ou=dept_123, o=prtyabmmxxx, o=a2anet>) to be notified with a [BankToCustomerDebitCreditNotification](#) message by the Output Dispatcher component.

Figure 174 – Intra-service Liquidity Transfer debit notification

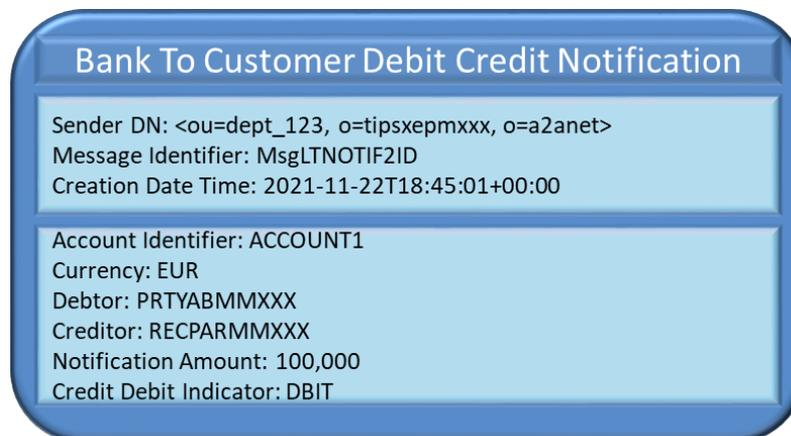

- TIPS checks whether the Credit Notification Flag related to the TIPS AS Technical Account to be credited is set to “True”; if so, it retrieves the Account Owner DN from the “Routing Configuration” in combination with the “Party Technical Address” (<ou=dept_123, o=ach1asmmxxx, o=a2anet>) to be notified with a [BankToCustomerDebitCreditNotification](#) message by the Output Dispatcher component.

Figure 175 – Intra-service Liquidity Transfer credit notification

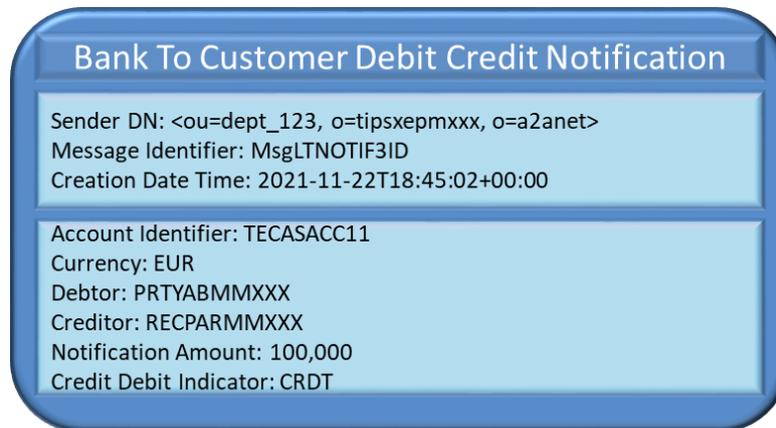

- It is worth noting that the creditor BIC reported in the notification contains the value RECPARMMXXX, i.e. the party on whose behalf the TIPS Participant transferred the liquidity to the technical account.

2.5.3.1.2 Unsuccessful scenario – intra-service LT order rejected for insufficient funds in TIPS

In this scenario:

- The current business date is 22/11/2021;
- A TIPS Participant (PRTYABMMXXX) sends an intra-system Liquidity Transfer request to move liquidity from its TIPS Account (ACCOUNT1) to a TIPS AS Technical Account (TECASACC1) owned by an Ancillary System (ACH1ASMMXXX);
- The transfer of liquidity is done by the TIPS Participant on behalf of a reachable party (RECPARMMXXX) previously authorised to settle on the TIPS AS Technical Account

Figure 176 – Unsuccessful intra-service Liquidity Transfer: LiquidityCreditTransfer



- The message router component processes the incoming request and performs the relevant checks related to the authorisations of the sending party and several business validations.
- TIPS identifies:
 - o The DN of the sender – i.e. the TIPS Participant or Instructing Party (<ou=dept_123, o=prtyabmmxxx, o=a2anet>);
 - o The Debtor (PRTYABMMXXX)
 - o The TIPS Account to be debited (ACCOUNT1) from the Debtor Account.
 - o The TIPS Account balance is equal to 900,000.00 EUR
 - o The TIPS AS Technical Account to be credited (TECASACC1) from the Creditor Account;
- TIPS detects that the current cash balance (900,000.00 EUR) of the debited TIPS Account involved is insufficient (the amount requested is 1,000,000.00 EUR).

Figure 177 – Insufficient balance on the debited account

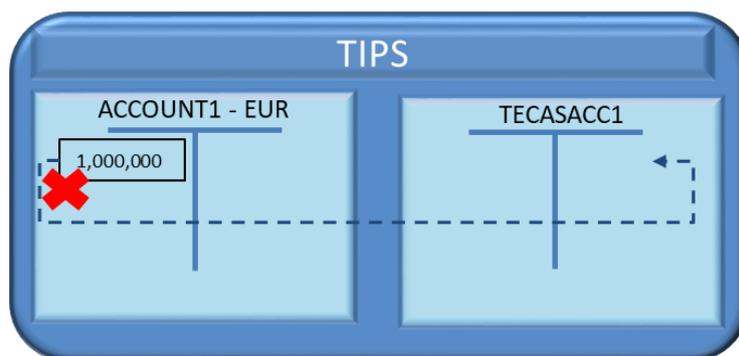

- The status of the intra-service Liquidity Transfer Order is set to *Failed* and a negative [Receipt \(camt.025.001.05\)](#) message is sent by TIPS in order to inform the sender.

Figure 178 – Negative intra-service Liquidity Transfer: Receipt

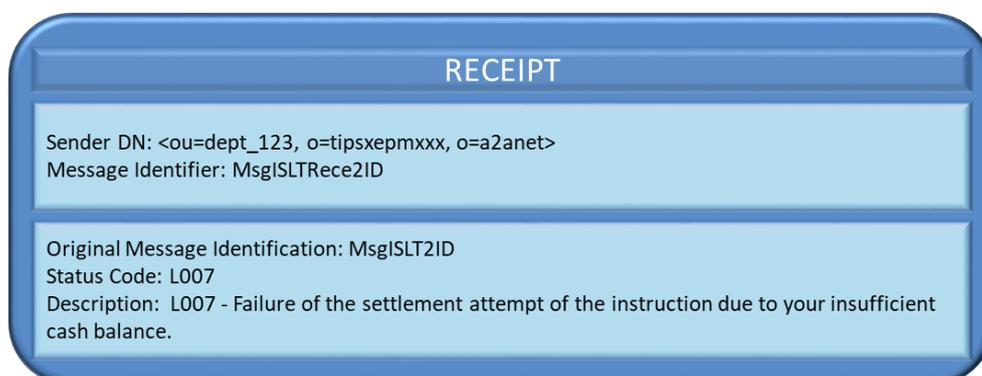

2.6. Notifications

The floor and ceiling notification process manages the sending of the notifications whenever, after a successful settlement process, the amount (or headroom) of the account (or the CMB) undercuts the floor amount or exceeds the ceiling amount configured by the account or CMB owner.

TIPS can generate a floor and ceiling notification related to an account after the successful settlement of either an Instant Payment transaction or a Liquidity Transfer.

TIPS can generate a floor and ceiling notification related to a CMB only after the successful settlement of an Instant Payment transaction.

The notifications are generated every time the threshold is undercut (floor) or exceeded (ceiling). TIPS does not generate new notifications if, after trespassing the threshold, the account balance or the CMB headroom remains consistently above the ceiling threshold or below the floor threshold.

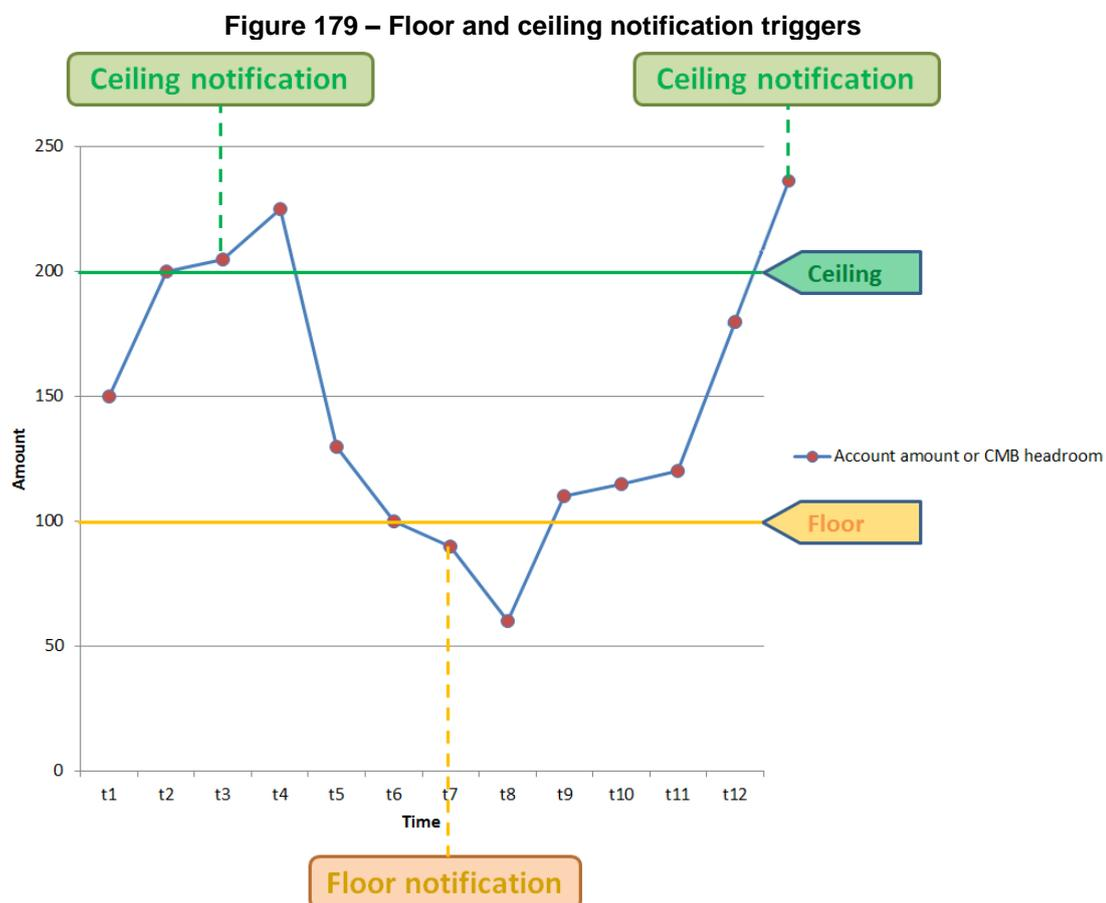

The examples below are based on Instant Payment transaction cases.

2.6.1. Floor notification on account

This positive scenario describes a successful Instant Payment transaction between two TIPS Accounts that generates a floor notification on the debited account. The scenario described is only an example

for the floor notification and how the message is triggered. The scenario is similar when the headroom of the CMB falls below the defined threshold. In this case, the message is generated and sent to the owner of the account linked to the CMB.

This example starts at the end of the [2.2.1.2.1 “ Successful scenario with confirmed order – only accounts involved”](#). The Account 1 has a Floor Amount set to 1,000.00 EUR. At the end of the settlement phase, the payment is confirmed and the Amount of the account is 900.00 EUR.

The system recognises that the account falls below the threshold defined by the customer and it starts the notification process.

Figure 180 – Floor notification settlement

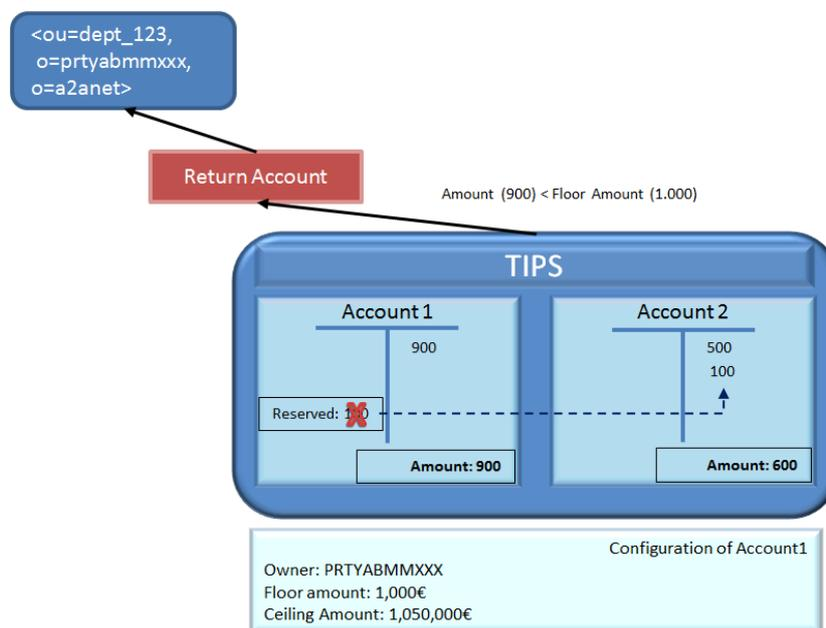

TIPS selects the Outbound DN of the owner of the account (or the default DN configured as receiver) and sends the message as follow.

Figure 181 – Floor notification ReturnAccount



The message is generated when a transaction is successfully settled and the account amount goes under the configured threshold.

Since both the CMB and the Account have their own and separate floor amount, when settling on a CMB it can happen that both CMB and Account go below their threshold. In this case, the owner of the account receives two separate messages, one notifying about the current headroom of the CMB and the other notifying the current account balance.

2.6.2. Ceiling notification on CMB

This positive scenario describes a successful Instant Payment transaction between two TIPS Actors that generates a ceiling notification on the credited CMB. The scenario described is only an example for the ceiling notification and how the message is triggered.

This example starts at the end of the [2.2.1.2.3 “ Successful scenario with confirmed order – Creditor CMB and debtor Account”](#). The CMB2 has a Ceiling Amount set to 400.00 EUR. At the end of the settlement phase, the payment is confirmed and the headroom of CMB2 is 449.00 EUR.

The system recognises that the CMB’s headroom has exceeded the threshold configured by the TIPS Actor and it triggers the notification process.

Figure 182 – Ceiling notification settlement

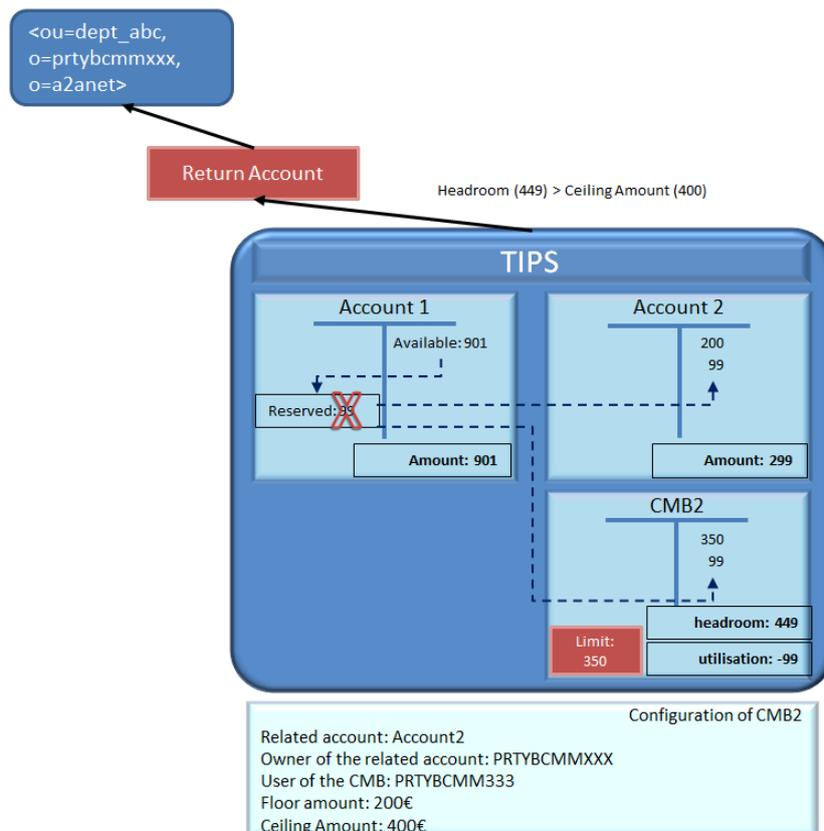

TIPS selects the owner of the account related to the CMB2 and its Outbound DN. Then TIPS sends the message as follow.

Figure 183 – Ceiling notification ReturnAccount

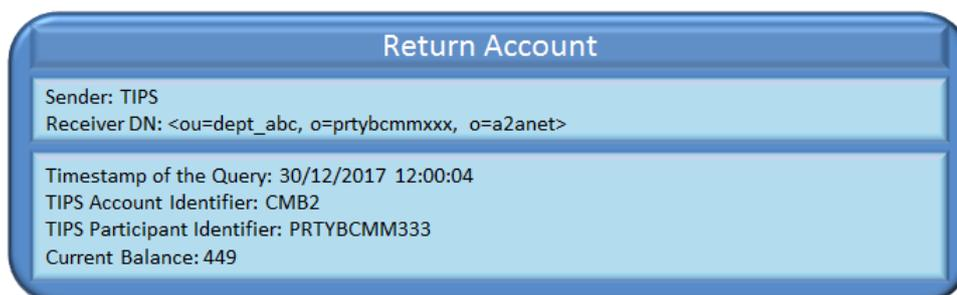

The message is generated when a transaction is successfully settled and the account amount exceeds the configured threshold.

Since both the CMB and the account have their own and separate ceiling amount, when settling on a CMB it can happen that both CMB and account exceed their threshold. In this case, the owner of the account receives two separate messages, one notifying about the current headroom of the CMB and the other notifying the current account balance.

2.7. Queries

This section focuses on the processing of a Query Request, with the description of the full scenario and its steps.

The section covers the scenarios in which a TIPS Participant, Ancillary System or Instructing Party queries the system in order to obtain information related to the balance and the status of an account, the limit and the status of a CMB or the status of a previously submitted or received Instant Payment transaction or Recall Response. This process is characterized by six different types of query:

- Account balance and status query;
- CMB limit and status query;
- Payment transaction status query;
- Advanced Payment transaction status query;
- Liquidity Transfer status query;
- Advanced Liquidity Transfer status query.

The remaining part of this chapter contains steps of the general flow and examples of possible scenarios for the *Account balance and status query*, *CMB limit and status query* and *Payment transaction status query*, with a focus on possible failing ones. Each example shows the relevant messages and how the main fields are filled.

TIPS shall take into account all access rights while processing queries and only return results if the queried data are part of the TIPS Actor data scope, as defined in the following table.

Table 67 – Query permissions

| Actor | Account Balance and Status Query | CMB Limit and Status Query | Payment Transaction Status Query and Advanced Payment Transaction Status Query | Liquidity transfer status Query and Advanced Liquidity transfer status Query |
|--|---|---|--|--|
| Central Bank | Accounts under the CB's responsibility | CMBs under the CB's responsibility | Payment transactions which involve either as originator BIC or as beneficiary BIC one of the TIPS Actors belonging to the data scope of the given Central Bank. | All liquidity transfers affecting accounts in their books |
| Participant | Accounts for which the Participant is owner or authorised | CMB for which the Participant is owner or authorised | Payment transactions which involve the Participant or one of its authorised Reachable Parties either as originator BIC or as beneficiary BIC | All liquidity transfers affecting their accounts |
| Reachable party | No | No | No | No |
| Instructing Party on behalf of a Participant | Accounts for which the Participant's BIC is owner or authorised | CMBs for which their Participant's BIC is owner or authorised | Payment transactions which involve either as originator BIC or as beneficiary BIC the Participant the Instructing Party is acting on behalf for. | On liquidity transfers they submitted |
| Instructing Party on behalf of a Reachable Party | Accounts for which the Reachable Party's BIC is set as authorised user | CMBs for which their Reachable Party's BIC is set as responsible or authorised user | Payment transactions which involve either as originator BIC or as beneficiary BIC the Reachable Party the Instructing Party is acting on behalf for. | No |
| Ancillary System | The TIPS AS Technical account for which the Ancillary system's BIC is owner | CMBs for which the Ancillary system's BIC is owner | Payment transactions which involve, either as originator BIC or as beneficiary BIC, TIPS Participants or Reachable parties that are authorised to settle on the TIPS AS Technical Account or a CMB linked to it. | All liquidity transfers affecting its TIPS AS Technical account |
| RTGS System | Accounts denominated in their currency | CMBs denominated in their currency | Not applicable | Not applicable |

If the queried data do not fall under the TIPS Actor data scope, an error is returned.

Involved actors and messages in Account Balance and Status Query and the CMB Limit and Status Query are:

- The TIPS Participant, Ancillary System or Instructing Party sending the query;
- [GetAccount](#) message in order to instruct the query;

- [ReturnAccount](#) message in order to receive the query response.

Involved actors and messages in Payment Transaction status query are:

- The TIPS Participant, Ancillary System or Instructing Party sending the query;
- [GetTransaction](#) message in order to instruct the query;
- [ReturnTransaction](#) message in order to receive the query response.

The Account balance and status query allows the authorised actor to get the detailed information for one or multiple accounts, specifying the account identifiers.

Returned data for each account queried are:

- TIPS Participant or Ancillary System identifier;
- TIPS Account or TIPS AS Technical identifier;
- Current account balance;
- Currency linked to the account;
- Account status;
- Timestamp of the query.

If the Account balance and status query is triggered in U2A mode, the authorised actor can retrieve the following information concerning the last Payment Transaction or Liquidity Transfer settled on the relevant account:

- Transaction Identification;
- Settlement timestamp.

The CMB limit and status query allows the authorised actor to get the detailed information for one or multiple CMBs, specifying as input parameter the TIPS CMB identifiers.

Returned data for each CMB queried are:

- TIPS Participant or Ancillary System identifier;
- TIPS Account or TIPS AS Technical identifier for the account linked to the CMB;
- TIPS CMB identifier;
- CMB limit;
- CMB headroom;
- Currency of the account to which the CMB is linked;
- CMB status;
- Timestamp of the query.

The Payment transaction status query allows the authorised actor to get the detailed information for one payment transaction, specifying as input parameter (i) the Originator Participant or Reachable Party BIC and (ii) the payment transaction reference.

Returned data for each Payment Transaction queried are:

- Originator BIC of the payment transaction;

- Beneficiary BIC of the payment transaction;
- Payment transaction reference;
- Payment transaction status;
- Amount of the payment transaction;
- Settlement timestamp (if available);
- Acceptance timestamp;
- Payment transaction reception timestamp⁴⁵;
- Payment transaction forwarding timestamp⁴⁶ (if available);
- Confirmation reception timestamp⁴⁷ (if available);
- Confirmation to the originator timestamp⁴⁸ (if available).

The Advanced Payment transaction status query allows the authorised actor to get detailed information for the payment transactions, based on the selected combination of the following search criteria:

- Originator BIC of the payment transaction;
- Beneficiary BIC of the payment transaction;
- Settlement business date;
- Lower bound of the search range for the Settlement Timestamp of the payment transaction;
- Upper bound of the search range for the Settlement Timestamp of the payment transaction;
- Lower bound of the search range for the Amount of the payment transaction;
- Upper bound of the search range for the Amount of the payment transaction;
- Cash Account;
- Transaction leg;
- Currency of the payment transaction;
- Lower bound of the search range for the Acceptance Timestamp of the payment transaction;
- Upper bound of the search range for the Acceptance Timestamp of the payment transaction;
- Status of the payment transaction;
- Error Code.

For each payment transaction, the following data shall be displayed on the list screen:

- Payment transaction reference;
- Originator BIC of the payment transaction;
- Beneficiary BIC of the payment transaction;

⁴⁵ The timestamp when the payment transaction is received by TIPS from the originator participant

⁴⁶ The timestamp when the payment transaction is forwarded to the beneficiary participant

⁴⁷ The timestamp when the confirmation for a payment transaction is received by TIPS from the beneficiary participant

⁴⁸ The timestamp when the confirmation for a payment transaction is forwarded by TIPS to the counterpart

- Acceptance Timestamp;
- Amount of the payment transaction;
- Settlement business date (if available);
- Status of the payment transaction;
- Error code (if available);
- Settlement Timestamp (if available);
- Transaction leg;
- Cash Account.

The Liquidity transfer status query allows the authorised actor to look up through a dedicated screen and get the detailed information for one liquidity transfer, specifying as input parameter both (i) the debtor BIC and (ii) the liquidity transfer reference.

The following data shall be displayed on the screen:

- Debtor BIC of the liquidity transfer;
- Creditor BIC of the liquidity transfer;
- Debtor Account;
- Creditor Account;
- Liquidity transfer reference;
- Liquidity transfer status;
- Amount of the liquidity transfer;
- The currency of the liquidity transfer;
- Settlement timestamp (if available).

The Advanced Liquidity transfer status query allows the authorised actor to get a list of liquidity transfers, specifying individually or in combination the following parameters as input:

- Debtor BIC of the liquidity transfer;
- Creditor BIC of the liquidity transfer;
- Cash Account;
- Liquidity transfer reference;
- Liquidity transfer status;
- Lower bound of the search range for the amount of the liquidity transfer;
- Upper bound of the search range for the amount of the liquidity transfer;
- Lower bound of the search range for the Business date;
- Upper bound of the search range for the Business date;
- Direction

For each liquidity transfer, the following data shall be displayed on the list screen:

- Liquidity transfer reference;
- Debtor BIC of the liquidity transfer;
- Creditor BIC of the liquidity transfer;
- Credited Cash Account;
- Debited Cash Account;
- Status of the liquidity transfer;
- Amount of the liquidity transfer;
- Settlement Date of the liquidity transfer.

All the described scenarios are triggered under the assumption that the technical validation, check of mandatory fields and authentication of the user have already been successfully performed by ESMIG.

It is important to keep in mind that when the [GetAccount](#) message contains a BIC8 instead of a BIC11, the message is accepted and the string is completed appending "XXX" at the end of the BIC8 for further processing. All the steps are described considering BIC11 only.

The diagram below describes the process and the involved actors for Account Balance Status query.

Figure 184 – Account Balance Status query flow

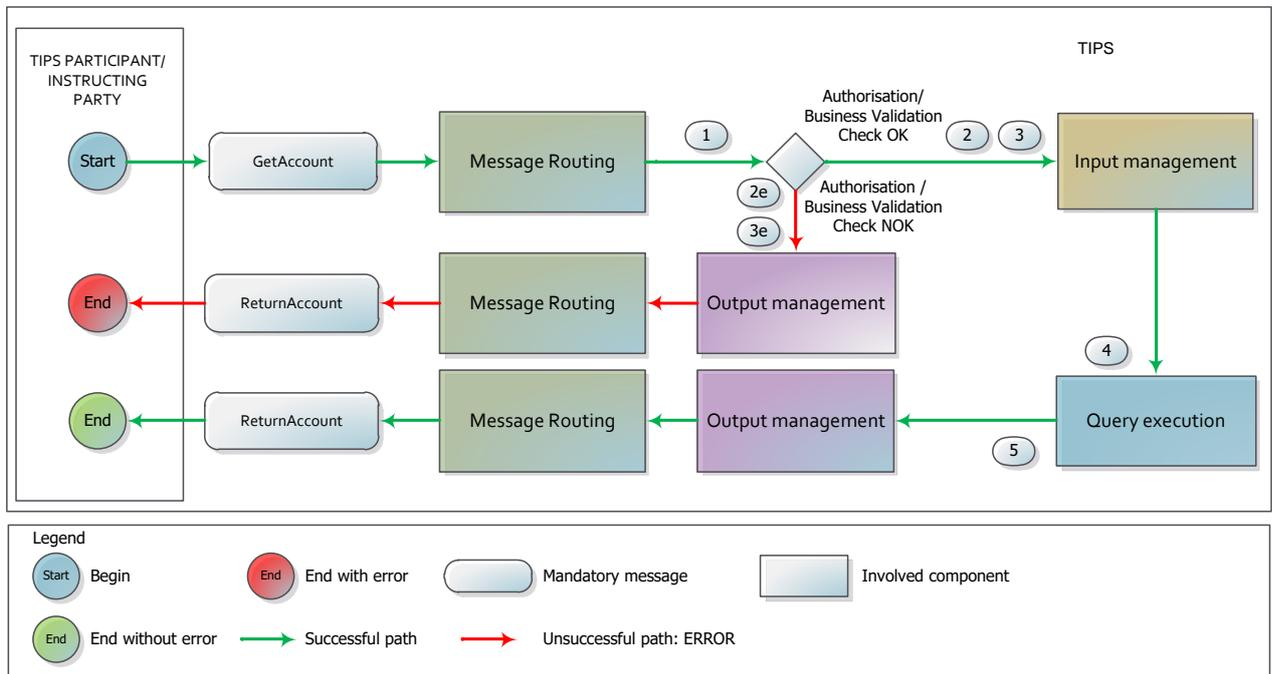

The details of the steps are described in the following table.

Table 68 – Account Balance Status query steps

| Step | Involved messages | Involved actors | Description |
|------|-------------------------------|--|--|
| 1 | GetAccount | Participant or Instructing Party as sender TIPS as receiver | TIPS receives an incoming Query from the Participant or Instructing Party. Technical validation, check of mandatory fields and authentication checks have already been successfully executed. |
| 2 | | TIPS | TIPS successfully executes the checks: - Access Rights check ; - Instructing Party authorised for queries; - Query uniformity check See 4.1- Business Rules for details. |
| 2e | ReturnAccount | TIPS as sender Participant or Instructing Party as receiver | TIPS unsuccessfully executes one of the checks of step 2 . At the first negative check the system stops and sends a message to the Participant or Instructing Party – same DN of the sender – containing the proper error code. |
| 3 | | TIPS | TIPS performs the following checks for each instance of the field “Account or CMB Identifier” of the GetAccount message (Account/CMB existence) : - for Account balance and status query, TIPS verifies that the value corresponds to an account type "TIPS Account" in the table "Cash Accounts" and if the Participant or Instructing Party is authorised to query on it based on the query permission (see Query permissions table). - for CMB limit and status query, TIPS verifies that the value corresponds to a CMB in the table "CMB" and if the Participant or Instructing Party is authorised to query on it based on the query permission (see Query permissions table). The system selects also the TIPS Account linked to the CMB; See 4.1- Business Rules for details. |

| Step | Involved messages | Involved actors | Description |
|------|-------------------------------|--|--|
| 3e | ReturnAccount | TIPS as sender Participant or Instructing Party as receiver | For every Account/CMB contained in the GetAccount message TIPS unsuccessfully executes one of the checks of step 3 . The system sends a message to the Participant or Instructing Party – same DN of the sender – containing the proper error code for each Account/CMB requested. |
| 4 | | TIPS | TIPS retrieves the data corresponding to the submitted query and its input parameters. For any Account/CMB whose check of step 3 has been unsuccessfully executed, the proper error code is reported. |
| 5 | ReturnAccount | TIPS as sender Participant or Instructing Party as receiver | The system sends a message to the Participant or Instructing Party – same DN of the query sender – containing the query results. |

The diagram below describes the process and the involved actors for Payment Transaction status query.

Figure 185 – Payment transaction status query flow

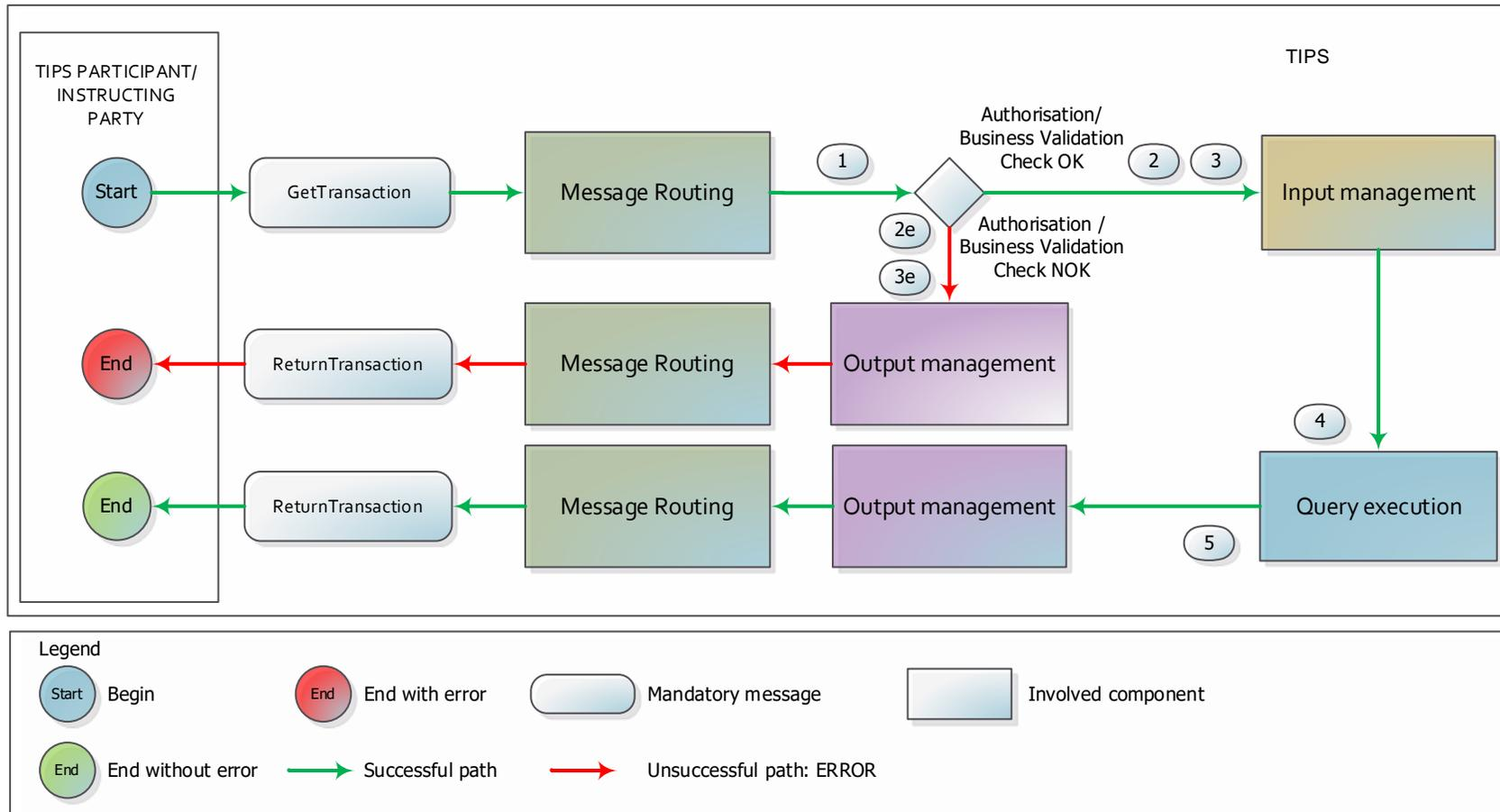

The details of the steps are described in the following table.

| Step | Involved messages | Involved actors | Description |
|------|-----------------------------------|---|--|
| 1 | GetTransaction | TIPS Participant, Ancillary System or Instructing Party as sender TIPS as receiver | TIPS receives an incoming Query from the TIPS Participant, Ancillary System or Instructing Party. Technical validation, check of mandatory fields and authentication checks have already been successfully executed. |
| 2 | | TIPS | TIPS successfully executes the checks: - Access Rights check ; See 4.1- Business Rules for details. |
| 2e | ReturnTransaction | TIPS as sender TIPS Participant, Ancillary System or Instructing Party as receiver | TIPS unsuccessfully executes the check of step 2 . At the first negative check the system stops and sends a message to the TIPS Participant, Ancillary System or Instructing Party – same DN of the sender – containing the proper error code. |
| 3 | | TIPS | TIPS successfully executes the check: - Payment Transaction existence for query See 4.1- Business Rules for details. |
| 3e | ReturnTransaction | TIPS as sender TIPS Participant, Ancillary System or Instructing Party as receiver | TIPS unsuccessfully executes the check of step 3 . In case of error the system stops and sends a message to the TIPS Participant, Ancillary System or Instructing Party – same DN of the sender – containing the proper error code. |
| 4 | | TIPS | TIPS retrieves the data corresponding to the submitted query and its input parameters. |
| 5 | ReturnTransaction | TIPS as sender TIPS Participant, Ancillary System or Instructing Party as receiver | The system sends a message to the TIPS Participant, Ancillary System or Instructing Party – same DN of the query sender – containing the query results. |

2.7.1. Examples

This sub-section presents different examples of the possible different scenarios related to the queries on Account/CMB and on Payment Transaction. Scenarios and examples are not exhaustive.

The first one provides the example of a non-empty answer to an Account balance and status query. The second one describes a non-empty answer to a CMB limit and status query. The third one provides an example of a TIPS rejection for the TIPS Account/CMB not found. The fourth one describes a non-empty answer to a Payment transaction status query. The last one provides an example of a TIPS rejection for a not existing Payment transaction.

For a detailed description of the (i) Payment transaction status query, (ii) Advanced Payment transaction status query, (iii) Liquidity Transfer status query and (iv) Advanced Liquidity Transfer status query_U2A screens, the reader may refer to the User Handbook (see [TARGET Instant Payment Settlement User Handbook](#)).

The figure below summarises, for each reference data object mentioned in the following examples, the related configuration.

Figure 186 – Queries examples: data constellation

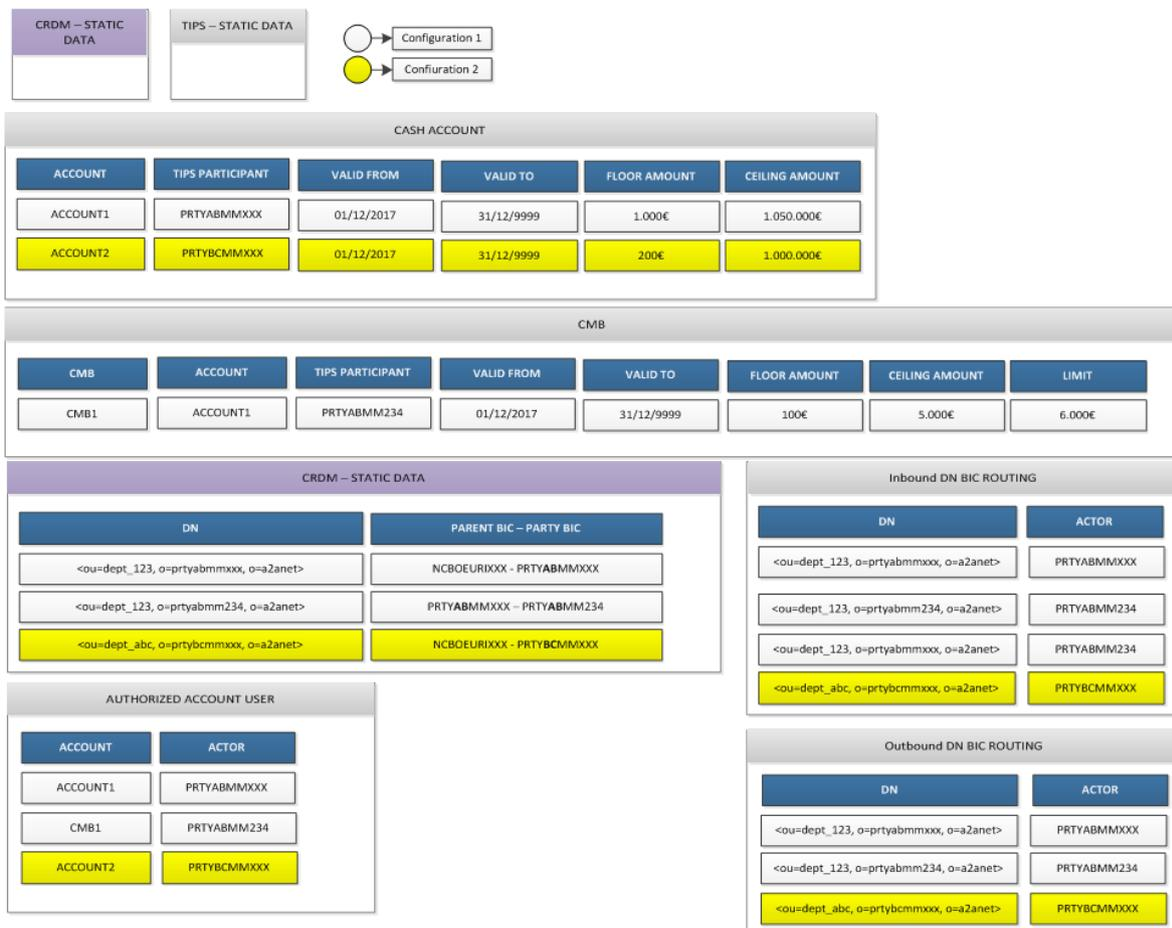

2.7.1.1. Successful scenario – Account balance and status query

In this scenario:

- A TIPS Participant (PRTYABMMXXX) sends a [GetAccount](#) message to TIPS to query the balance and the status an account (ACCOUNT1);
- The TIPS Account balance for ACCOUNT1 is 10,000.00 EUR;
- The TIPS Account is active, open and not blocked.

Figure 187 – Successful GetAccount



- TIPS identifies:
 - o The DN of the sender – i.e. the TIPS Participant or Instructing Party (<ou=dept_123, o=prtyabmmxxx, o=a2anet>);
 - o The Account (ACCOUNT1);
 - o The Account Owner (PRTYABMMXXX).
- TIPS selects the actual balance of the Account;
- A [ReturnAccount](#) message is sent by TIPS to the same DN of the query sender, containing the query results.

Figure 188 – Successful ReturnAccount

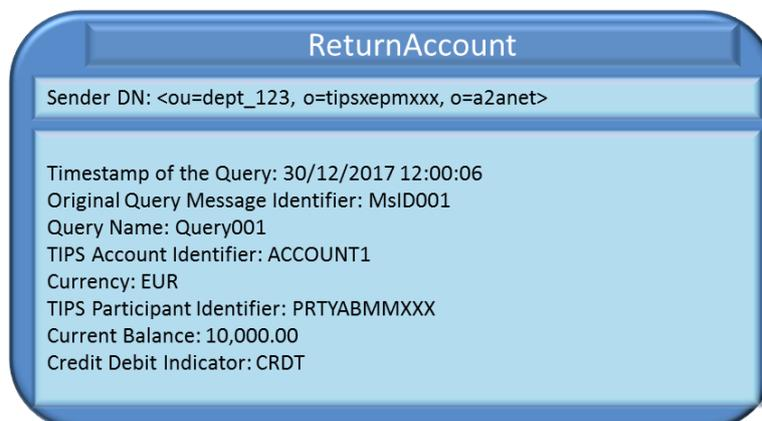

2.7.1.2. Successful scenario – CMB limit and status query

In this scenario:

- A TIPS Participant (PRTYABMMXXX) sends a [GetAccount](#) message to TIPS to query the status of a CMB (CMB01), linked to a TIPS Account (ACCOUNT1), used by the Reachable Party;
- The TIPS CMB limit for CMB1 is 6,000.00 EUR;
- The TIPS CMB utilisation for CMB1 is 5,200.00 EUR;
- The TIPS CMB Headroom for CMB1 is 800.00 EUR;
- The CMB is active, open and not blocked.

Figure 189 – Successful GetAccount



- TIPS identifies:
 - o The DN of the sender – i.e. the TIPS Instructing Party (<ou=dept_123, o=prtyabmmxxx, o=a2anet>);
 - o The CMB (CMB1);
 - o The Account (ACCOUNT1);
 - o The Account Owner (PRTYABMMXXX).
- TIPS identifies the actual balance of the Account
- A [ReturnAccount](#) message is sent by TIPS to the same DN of the query sender, containing the query results.

Figure 190 – Successful ReturnAccount

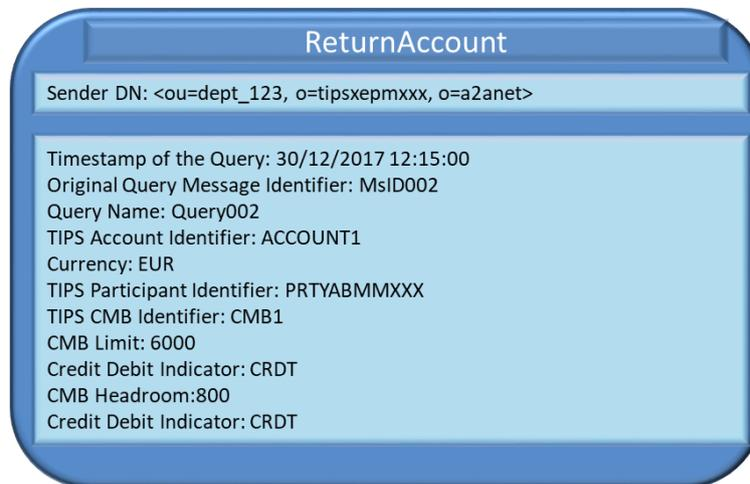

2.7.1.3. Unsuccessful scenario – TIPS Account/CMB not found

In this scenario:

- A TIPS Participant (PRTYABMMXXX) sends a [GetAccount](#) message to TIPS to query the balance and the status of an account (ACCOUNT2);
- ACCOUNT2 is not a TIPS Account.

Figure 191 – Unsuccessful GetAccount

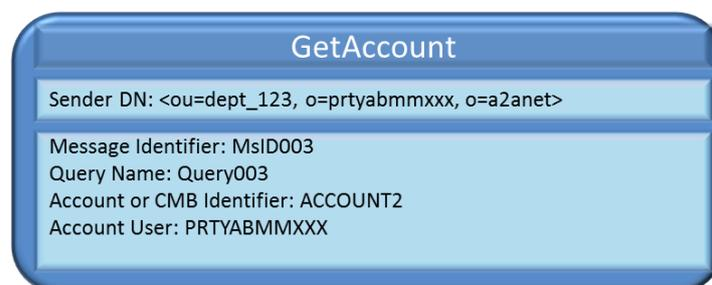

- TIPS does not identify ACCOUNT2 as TIPS Account/CMB.

Figure 192 – Unsuccessful GetAccount: account retrieval failure

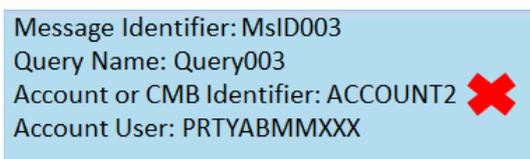

- A [ReturnAccount](#) message is sent by TIPS to the same DN of the query sender, containing the error code.

Figure 193 – Unsuccessful ReturnAccount

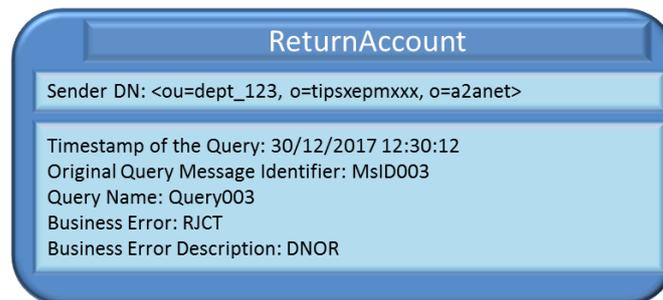

2.7.1.4. Successful scenario – Payment transaction status query

In this scenario:

- A TIPS Participant (PRTYABMMXXX) sends a GetTransaction message to TIPS to query the Payment Transaction with Transaction Identification MSID432388834674 and Debtor BIC PRTYABMMXXX, which has been settled.

Figure 194 – Successful GetTransaction



- TIPS identifies:
 - o The DN of the sender – i.e. the TIPS Instructing Party <ou=dept_123, o=prtyabmmxxx, o=a2anet>);
 - o The Payment Transaction (MSID432388834674 with Debtor BIC PBBKITRRXXX);
- TIPS identifies the status of the Payment transaction and the related timestamps;
- A ReturnTransaction message is sent by TIPS to the same DN of the query sender, containing the query results.

Figure 195 – Successful ReturnTransaction

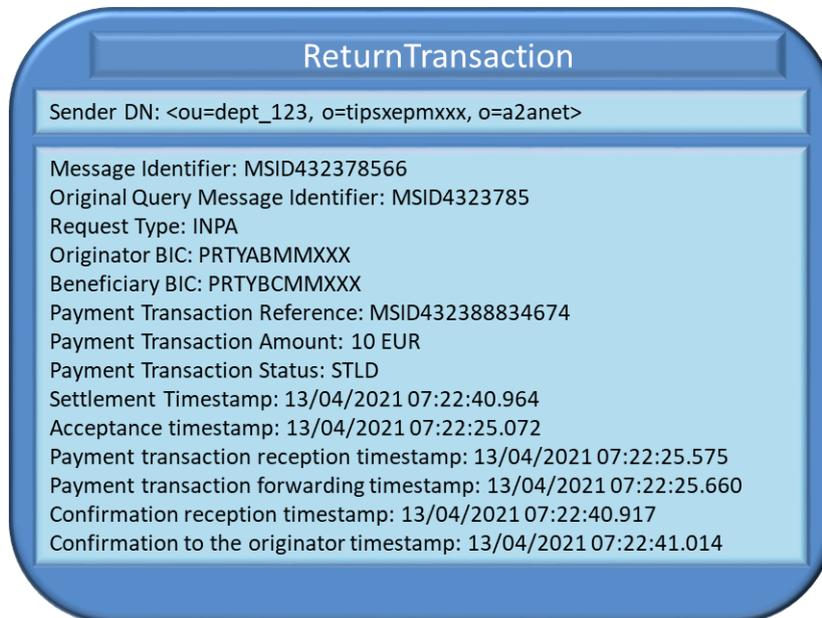

2.7.1.5. Unsuccessful scenario – Payment transaction status query

In this scenario:

- A TIPS Participant (PRTYABMMXXX) sends a GetTransaction message to TIPS to query the Payment Transaction with Transaction Identification MSID432388834675 and Debtor BIC PRTYABMMXXX, which is unknown to TIPS.

Figure 196 – Unsuccessful GetTransaction



TIPS does not identify any Payment Transaction with the couple MSID432388834675 and Debtor BIC PRTYABMMXXX.

Figure 197 – Unsuccessful GetTransaction: Payment Transaction retrieval failure



- A ReturnTransaction message is sent by TIPS to the same DN of the query sender, containing the error code.

Figure 198 – Unsuccessful ReturnTransaction



2.8. Reports

This section describes the processing steps for the creation of reports available in TIPS and their sending out from TIPS to the TIPS Actors who subscribe to them.

TIPS provides the following report types:

- Statement of Account Turnover;
- Statement of Accounts.

The above reports are generated using the data available at the time scheduled in the report subscription or at the end of day of the corresponding RTGS System.

TIPS provides TIPS actors with reports on their accounts based on the permissions listed in the following table.

Table 69 – Report permissions and data scope

| Actor | Statement of Account Turnover | Statement of Accounts |
|--------------|-------------------------------|-----------------------|
| Central Bank | No | No |

| | | |
|--|---|---|
| Participant | Own accounts | Own accounts ⁴⁹ |
| Reachable party | No | No |
| Instructing Party on behalf of a Participant | Accounts of the Participant on behalf of which the Instructing Party is operating | Accounts of the Participant on behalf of which the Instructing Party is operating |
| Instructing Party on behalf of a Reachable Party | No | No |
| Ancillary system | Own TIPS AS Technical account | Own TIPS AS Technical account |

2.8.1. Statement of Account Turnover

The Statement of Account Turnover report provides the following information for all the accounts in the data scope of the Recipient actor:

- RTGS business date for which the information is retrieved;
- TIPS Participant or Ancillary System identifier;
- TIPS Account or TIPS AS Technical Account identifier;
- Currency of the account;
- Opening balance at start of RTGS business day;
- Closing balance at end of RTGS business day;
- Sum of debits for the account;
- Sum of credits for the account.

TIPS provides the Statement of Account Turnover in a complete version only (Full mode) and covers the time between start and end of RTGS business day⁵⁰.

Reserved amounts are included in the calculation of the Opening balance at start of RTGS business day and the Closing balance at end of RTGS business day.

The involved actors and messages are:

- The Recipient: i.e., the subscribing TIPS Participant or Ancillary System who receives the report;
- [BankToCustomerAccountReport](#) message sent from TIPS to the Recipient in order to provide the Statement of Account Turnover report.

The following diagram displays the Statement of Account Turnover generation process which is triggered in TIPS.

⁴⁹ The Statement of Accounts contains settled transactions on CMBs linked to the Participant's accounts as well.

⁵⁰ Due to the fact that the Scheduled Frequency is an irrelevant report subscription parameter for full reports, the trigger could be only an RTGS System business day change.

Figure 199 – Statement of Account Turnover flow

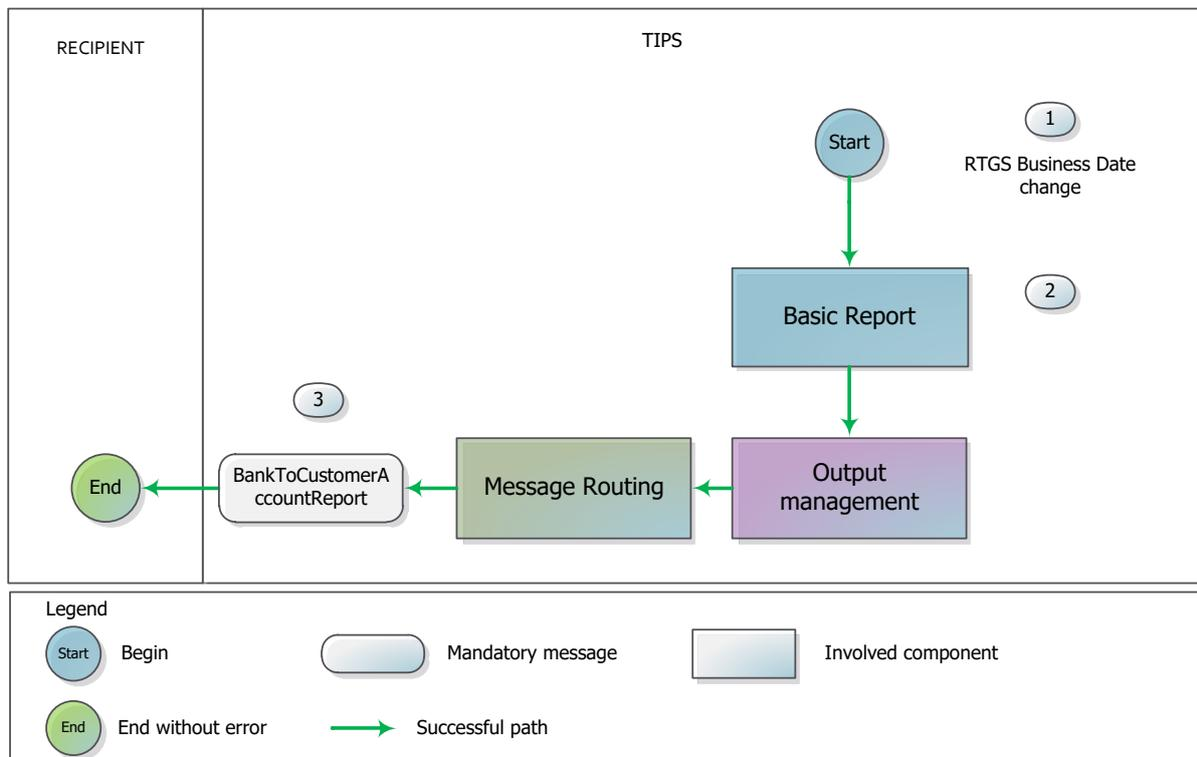

The details of the steps are described in the following table.

Table 70 – Statement of Account Turnover steps

| Step | Involved messages | Involved actors | Description |
|------|---|---|---|
| 1 | | TIPS | Following the change of the business date of the relevant RTGS system, TIPS triggers the Statement of Account Turnover generation process. |
| 2 | | TIPS | The whole set of balances in TIPS is saved by means of a "snapshot" operation, TIPS processes all data from the snapshot necessary for the report generation in accordance with the relevant configuration, adding transactional data and enriching it with reference data. Subsequently, the report data is grouped and formatted. The Statement of Account Turnover is created. |
| 3 | BankToCustomerAccountReport | TIPS as sender Recipient as receiver | TIPS sends the Statement of Account Turnover to the previously defined Recipient. |

2.8.1.1. Examples

The following example shows how the Statement of Account Turnover creation process takes place in accordance to the following report configuration. Scenarios and examples are not exhaustive.

Figure 200 – Statement of Account Turnover example: report subscription

| Report Subscription | |
|--------------------------------|-------------------------------|
| Report Subscription Identifier | SoAT_PRTYABMXXX |
| Report | Statement of Account Turnover |
| Recipients | PRTYABMXXX |
| Mode | Full Mode |
| Scheduled Frequency | |
| Subscription Valid From | 15/12/2017 |
| Subscription Valid To | 31/12/9999 |

This representative case is based on the data constellation provided hereunder.

Figure 201 – Statement of Account Turnover example: data constellation

| CASH ACCOUNT | | | |
|--------------|------------------|------------|------------|
| ACCOUNT | TIPS PARTICIPANT | VALID FROM | VALID TO |
| ACCOUNT1 | PRTYABMMXXX | 01/12/2017 | 31/12/9999 |

| CMBs | | | | |
|------|----------|------------------|------------|------------|
| CMB | ACCOUNT | TIPS PARTICIPANT | VALID FROM | VALID TO |
| CMB1 | ACCOUNT1 | PRTYABMM234 | 01/12/2017 | 31/12/9999 |

| Outbound DN BIC ROUTING | |
|--|-------------|
| DN | ACTOR |
| <ou=dept_123, o=prtyabmmxxx, o=a2anet> | PRTYABMMXXX |
| <ou=dept_123, o=prtyabmm234, o=a2anet> | PRTYABMM234 |

| PARTY TECHNICAL ADDRESS | |
|--|-------------|
| DN | ACTOR |
| <ou=dept_123, o=prtyabmmxxx, o=a2anet> | PRTYABMMXXX |
| <ou=dept_123, o=prtyabmm234, o=a2anet> | PRTYABMM234 |

| Inbound DN BIC ROUTING | |
|--|-------------|
| DN | ACTOR |
| <ou=dept_123, o=prtyabmmxxx, o=a2anet> | PRTYABMMXXX |
| <ou=dept_234, o=prtyabmmxxx, o=a2anet> | PRTYABMMXXX |
| <ou=dept_123, o=prtyabmmxxx, o=a2anet> | PRTYABMM234 |
| <ou=dept_123, o=prtyabmm234, o=a2anet> | PRTYABMM234 |

2.8.1.1 Statement of Account Turnover

For the sake of this example, it is assumed that: i) the opening balance at the start of RTGS business day (15/12/2017) for the ACCOUNT1 is 500.00 EUR; ii) the RTGS system open at 7 a.m. and close at 6 p.m.; no interruption of the service or disruptive event would occur.

- The following payment transactions are received and settled in TIPS during the current RTGS business date (15/12/2017).

Figure 202 – Statement of Account Turnover example: list of transactions

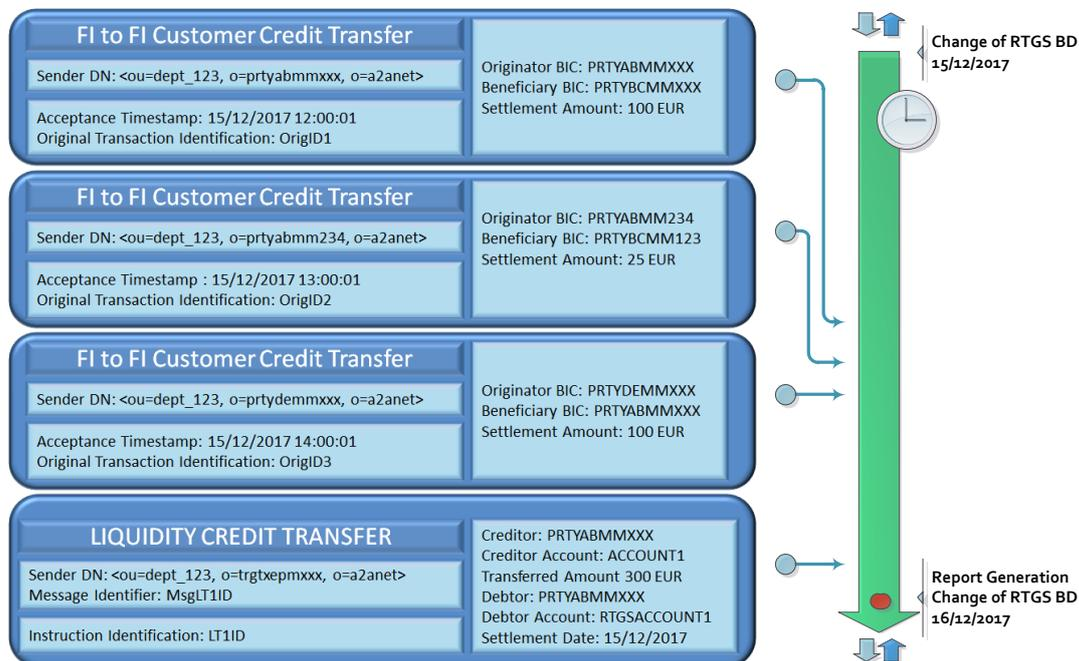

- On receipt of the notification made by the relevant RTGS system, the RTGS business date parameter is updated accordingly in TIPS (16/12/2017);
- The snapshot of in-memory balances is taken as it is needed to produce the report;
- The Basic Report component retrieves the data to be included in the Statement of Account Turnover;
- The system identifies the Recipient DN from the “Routing Configuration” in combination with the “Party Technical Address” (<ou=dept_123, o=prtyabmmxxx, o=a2anet>);
- The Message Router component sends the following [BankToCustomerAccountReport](#) message to the Recipient.

Figure 203 – Statement of Account Turnover example: BankToCustomerAccountReport

Bank To Customer Account Report

Sender DN: <ou=dept_123, o=tipsxepmxxx, o=a2anet>
 Message Identifier: MsgIDRptSoAT151217

Report Identifier: IDRptSoAT151217

Account Identification: ACCOUNT1
 Account Currency: EUR
 Account Owner: PRTYABMMXXX

| | |
|--|--|
| <p>Balance Type: OPBD Amount: 500 EUR Credit/Debit Indicator: CRDT RTGS Business date: 15/12/2017</p> <p>-----</p> <p>Balance Type: CLBD Amount: 775 EUR Credit/Debit Indicator: CRDT RTGS Business date: 15/12/2017</p> | <p>Sum of debits: 125 EUR Sum of credits: 400 EUR</p> |
|--|--|

2.8.2. Statement of Accounts

The Statement of Accounts report provides detailed information on the activities recorded for all the TIPS Accounts and TIPS AS Technical Accounts in the data scope of the Recipient actor.

The report contains:

- RTGS business date for which the information is retrieved;
- TIPS Participant or Ancillary System identifier;
- TIPS Account or TIPS AS Technical Account identifier;
- Currency of the account;
- Account Balance (based on the latest data available);
- Start Timestamp for which the account statement is issued;
- End Timestamp for which the account statement is issued;

For all the transactions settled⁵¹ on the reported accounts, TIPS provides the following details:

- Payment transaction reference;
- BIC of the Originator Participant of the transaction;
- Payment transaction Amount;
- Bank transaction code of the transaction;

⁵¹ These transactions are payment transactions or liquidity transfers.

- Initial balance before the execution of the payment transaction;
- Final balance after the execution of the payment transaction;
- Settlement timestamp.

TIPS provides the Statement of Accounts in Full or Delta mode.

Delta report covers the time between the last report trigger and the trigger time scheduled in the report subscription. When subscribing for a report in Delta mode, the end of day of the relevant RTGS System triggers in any case a last report generation for the business day which contains all the data remaining between the trigger itself and the last report produced for the interested Actor.

As for the calculation of the initial/final balances stemming from the execution of a payment transaction, the values are calculated by neutralizing the effect of any pending concurrent transaction “in-flight”, i.e. any Instant Payment in its conditional phase or any Outbound Liquidity Transfer in status ‘transient’ that are insisting on the same TIPS Account.

Full report covers the time since the start RTGS business day and the end of RTGS business day⁵².

The involved actors and messages are:

- The Recipient: i.e., the subscribing TIPS Participant or Ancillary System who receives the report;
- [BankToCustomerStatement](#) message sent from TIPS to the Recipient in order to provide the Statement of Accounts report.

The following diagram displays the Statement of Accounts generation process which is triggered in TIPS.

⁵² Due to the fact that the Scheduled Frequency is an irrelevant report subscription parameter for full reports, the trigger could be only an RTGS System business day change.

Figure 204 – Statement of Accounts flow

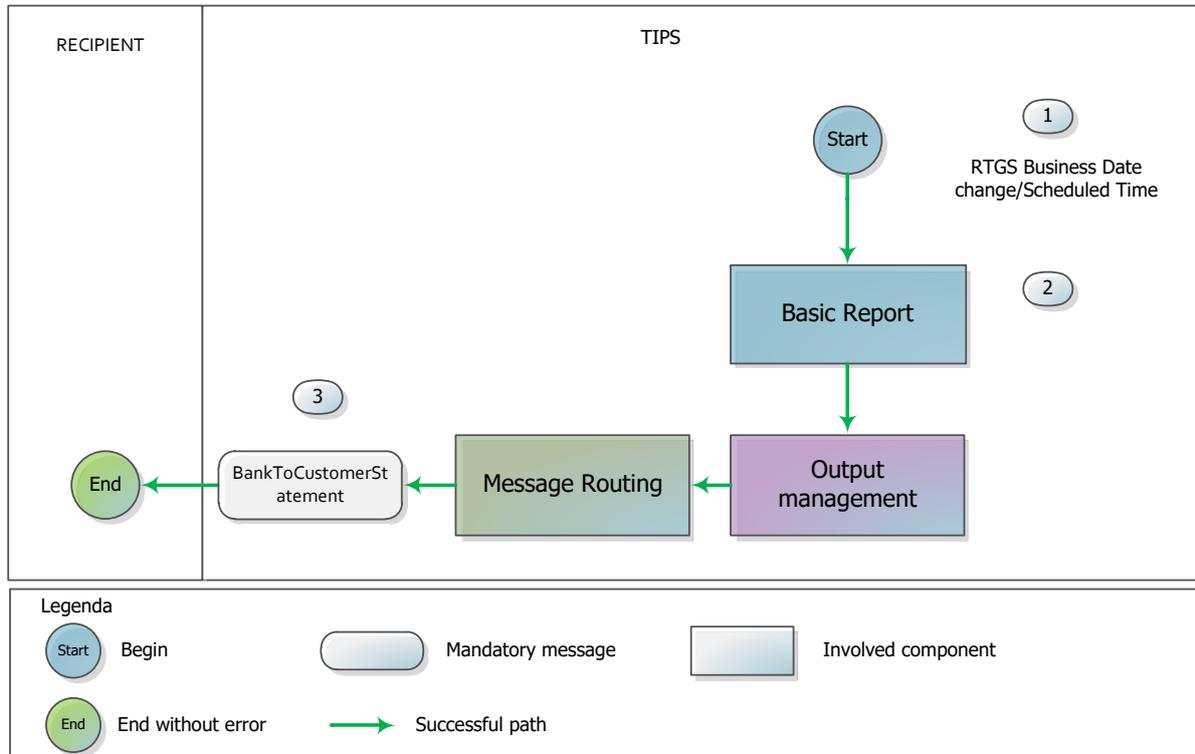

The details of the steps are described in the following table.

Table 71 – Statement of Accounts steps

| Step | Involved messages | Involved actors | Description |
|------|---|---|---|
| 1 | | TIPS | Following the change of the business date of the relevant RTGS system or when the scheduled time is reached, TIPS triggers the Statement of Accounts generation process. |
| 2 | | TIPS | The whole set of balances in TIPS is saved by means of a “snapshot” operation, TIPS processes all data from the snapshot necessary for the report generation in accordance with the relevant configuration, adding transactional data and enriching it with reference data. Subsequently, the report data is grouped and formatted. The Statement of Accounts is created. |
| 3 | BankToCustomerStatement | TIPS as sender Recipient as receiver | TIPS sends the Statement of Accounts to the previously defined Recipient. |

2.8.2.1. Examples

The following examples show how the Statement of Accounts creation process takes place in accordance to the following report configurations. Scenarios and examples are not exhaustive.

[Figure 205](#) and [Figure 206](#) show the report subscription underlying the first and second example respectively.

Figure 205 – Statement of Accounts example: report subscription (full mode)

| Report Subscription | |
|--------------------------------|-----------------------|
| Report Subscription Identifier | SoA_PRTYABMXXX |
| Report | Statement of Accounts |
| Recipients | PRTYABMXXX |
| Mode | Full Mode |
| Scheduled Frequency | |
| Subscription Valid From | 15/12/2017 |
| Subscription Valid To | 31/12/9999 |

Figure 206 – Statement of Accounts example: report subscription (delta mode)

| Report Subscription | |
|--------------------------------|-----------------------|
| Report Subscription Identifier | SoA_PRTYABMXXX |
| Report | Statement of Accounts |
| Recipients | PRTYABMXXX |
| Mode | Delta Mode |
| Scheduled Frequency | 3 hours |
| Subscription Valid From | 15/12/2017 |
| Subscription Valid To | 31/12/9999 |

[Figure 207](#) shows the details of the reference data setup for both the examples.

Figure 207 – Statement of Accounts example: data constellation

| CASH ACCOUNT | | | |
|--------------|------------------|------------|------------|
| ACCOUNT | TIPS PARTICIPANT | VALID FROM | VALID TO |
| ACCOUNT1 | PRTYABMMXXX | 01/12/2017 | 31/12/9999 |

| CMBs | | | | |
|------|----------|------------------|------------|------------|
| CMB | ACCOUNT | TIPS PARTICIPANT | VALID FROM | VALID TO |
| CMB1 | ACCOUNT1 | PRTYABMM234 | 01/12/2017 | 31/12/9999 |

| Outbound DN BIC ROUTING | |
|--|-------------|
| DN | ACTOR |
| <ou=dept_123, o=prtyabmmxxx, o=a2anet> | PRTYABMMXXX |
| <ou=dept_123, o=prtyabmm234, o=a2anet> | PRTYABMM234 |

| PARTY TECHNICAL ADDRESS | |
|--|-------------|
| DN | ACTOR |
| <ou=dept_123, o=prtyabmmxxx, o=a2anet> | PRTYABMMXXX |
| <ou=dept_123, o=prtyabmm234, o=a2anet> | PRTYABMM234 |

| Inbound DN BIC ROUTING | |
|--|-------------|
| DN | ACTOR |
| <ou=dept_123, o=prtyabmmxxx, o=a2anet> | PRTYABMMXXX |
| <ou=dept_234, o=prtyabmmxxx, o=a2anet> | PRTYABMMXXX |
| <ou=dept_123, o=prtyabmmxxx, o=a2anet> | PRTYABMM234 |
| <ou=dept_123, o=prtyabmm234, o=a2anet> | PRTYABMM234 |

2.8.2.1.1 Statement of Accounts – Full mode

The underlying assumptions for this representative case are the following: i) the opening balance at the start of RTGS business day (15/12/2017) for the ACCOUNT1 is 500.00 EUR; ii) the RTGS system open at 7 a.m. and close at 6 p.m.; no interruption of the service or disruptive event would occur.

- The following payment transactions are received and settled in TIPS during the current RTGS business date (15/12/2017).

Figure 208 – Statement of Accounts example: list of transactions (full mode)

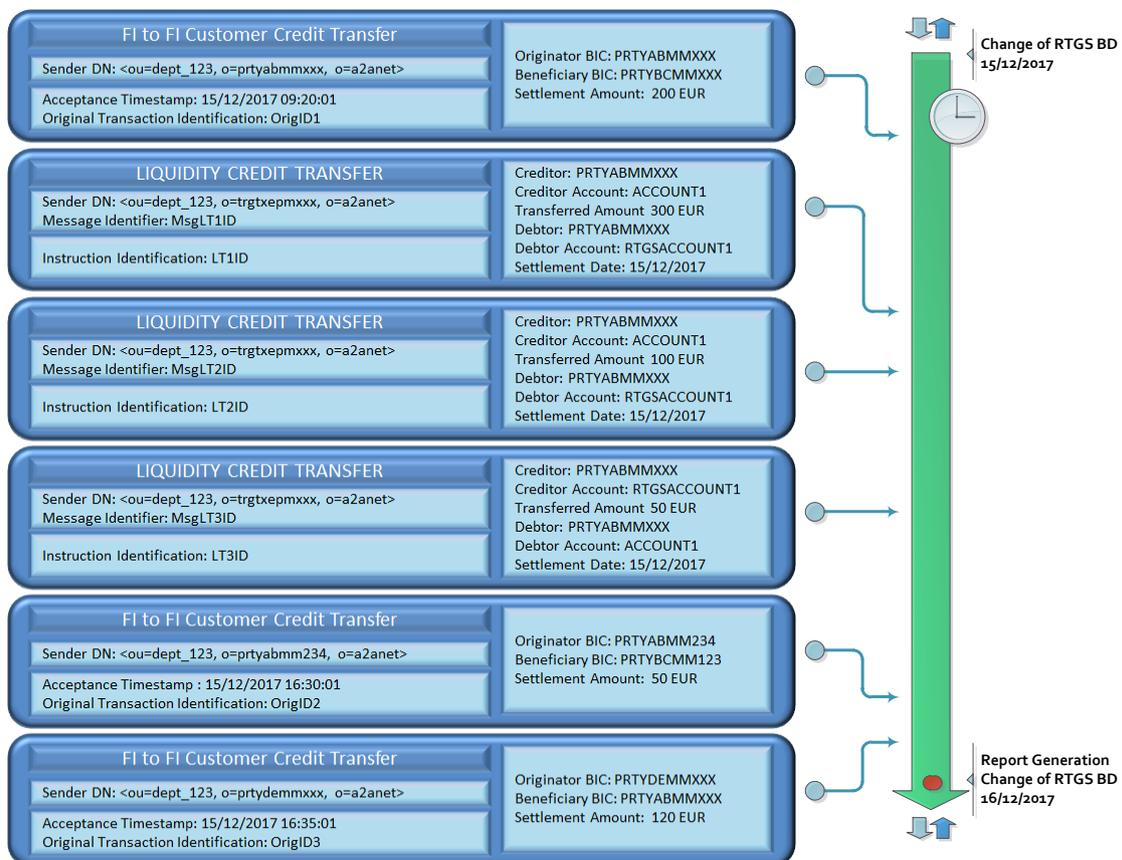

- On receipt of the notification made by the relevant RTGS system, the RTGS business date parameter is updated accordingly in TIPS (16/12/2017);
- The system takes the snapshot of in-memory balances and downloads transaction data from the database;
- The Basic Report component retrieves the data to be included in the Statement of Accounts;
- The system identifies the Recipient DN from the “Routing Configuration” in combination with the “Party Technical Address” (<ou=dept_123, o=prtyabmmxxx, o=a2anet>);
- The Message Router component sends the following [BankToCustomerStatement](#) message to the Recipient.

Figure 209 – Statement of Accounts example: BankToCustomerStatement

| Bank To Customer Statement | | |
|--|--|--|
| Sender DN: <ou=dept_123, o=tipsxepmxxx, o=a2anet> Message Identifier: MsgIDRptSoA151217 Creation Date Time: 2017-12-15T18:01:00:00Z | | |
| Statement Identifier: 1 Account Identification: ACCOUNT1 Account Currency: EUR Account Owner: PRTYABMMXXX Balance Type: CLBD Amount: 720 EUR Credit/Debit Indicator: CRDT RTGS Business date: 15/12/2017 | | |
| Transaction Reference: OrigID1 Transaction Amount: 200 EUR Transaction Credit/Debit Indicator: DBIT Transaction Status: BOOK Settlement timestamp: 15/12/2017 09:20:05 Bank Transaction Code Family: IRCT Bank transaction code: PMNT Bank Transaction Code SubFamily: FICT ----- Transaction Account Balance: 500 EUR Transaction Account Balance Type: BFTS ----- Transaction Account Balance: 300 EUR Transaction Account Balance Type: FTTS ----- Transaction Amount: 200 EUR Transaction Credit/Debit Indicator: DBIT Transaction Originator BIC: PRTYABMMXXX Transaction Beneficiary BIC: PRTYBCMXXX | Transaction Reference: LT1ID Transaction Amount: 300 EUR Transaction Credit/Debit Indicator: CRDT Transaction Status: BOOK Settlement timestamp: 15/12/2017 10:20:00 Bank Transaction Code Family: RCDDT Bank transaction code: PMNT Bank Transaction Code SubFamily: FICT ----- Transaction Account Balance: 300 EUR Transaction Account Balance Type: BFTS ----- Transaction Account Balance: 600 EUR Transaction Account Balance Type: FTTS ----- Transaction Amount: 300 EUR Transaction Credit/Debit Indicator: CRDT Transaction Originator BIC: PRTYABMMXXX Transaction Beneficiary BIC: PRTYABMMXXX | Transaction Reference: LT2ID Transaction Amount: 100 EUR Transaction Credit/Debit Indicator: CRDT Transaction Status: BOOK Settlement timestamp: 15/12/2017 11:00:00 Bank Transaction Code Family: RCDDT Bank transaction code: PMNT Bank Transaction Code SubFamily: FICT ----- Transaction Account Balance: 600 EUR Transaction Account Balance Type: BFTS ----- Transaction Account Balance: 700 EUR Transaction Account Balance Type: FTTS ----- Transaction Amount: 100 EUR Transaction Credit/Debit Indicator: CRDT Transaction Originator BIC: PRTYABMMXXX Transaction Beneficiary BIC: PRTYABMMXXX |
| Transaction Reference: LT3ID Transaction Amount: 50 EUR Transaction Credit/Debit Indicator: DBIT Transaction Status: BOOK Settlement timestamp: 15/12/2017 14:00:00 Bank Transaction Code Family: ICDT Bank transaction code: PMNT Bank Transaction Code SubFamily: FICT ----- Transaction Account Balance: 700 EUR Transaction Account Balance Type: BFTS ----- Transaction Account Balance: 650 EUR Transaction Account Balance Type: FTTS ----- Transaction Amount: 50 EUR Transaction Credit/Debit Indicator: DBIT Transaction Originator BIC: PRTYABMMXXX Transaction Beneficiary BIC: PRTYABMMXXX | Transaction Reference: OrigID2 Transaction Amount: 50 EUR Transaction Credit/Debit Indicator: DBIT Transaction Status: BOOK Settlement timestamp: 15/12/2017 16:30:05 Bank Transaction Code Family: IRCT Bank transaction code: PMNT Bank Transaction Code SubFamily: FICT ----- Transaction Account Balance: 650 EUR Transaction Account Balance Type: BFTS ----- Transaction Account Balance: 600 EUR Transaction Account Balance Type: FTTS ----- Transaction Amount: 50 EUR Transaction Credit/Debit Indicator: DBIT Transaction Originator BIC: PRTYABMM234 Transaction Beneficiary BIC: PRTYBCM123 | Transaction Reference: OrigID3 Transaction Amount: 120 EUR Transaction Credit/Debit Indicator: CRDT Transaction Status: BOOK Settlement timestamp: 15/12/2017 16:35:05 Bank Transaction Code Family: RRCT Bank transaction code: PMNT Bank Transaction Code SubFamily: FICT ----- Transaction Account Balance: 600 EUR Transaction Account Balance Type: BFTS ----- Transaction Account Balance: 720 EUR Transaction Account Balance Type: FTTS ----- Transaction Amount: 120 EUR Transaction Credit/Debit Indicator: CRDT Transaction Originator BIC: PRTYDEMXXX Transaction Beneficiary BIC: PRTYABMMXXX |

2.8.2.1.2 Statement of Accounts – Delta mode

The same assumptions are used in this example as in the above example illustrating the creation of a Statement of Accounts in Full mode.

- The following payment transactions are received and settled in TIPS during the current RTGS business date (15/12/2017).

Figure 210 – Statement of Accounts example: list of transaction (delta mode)

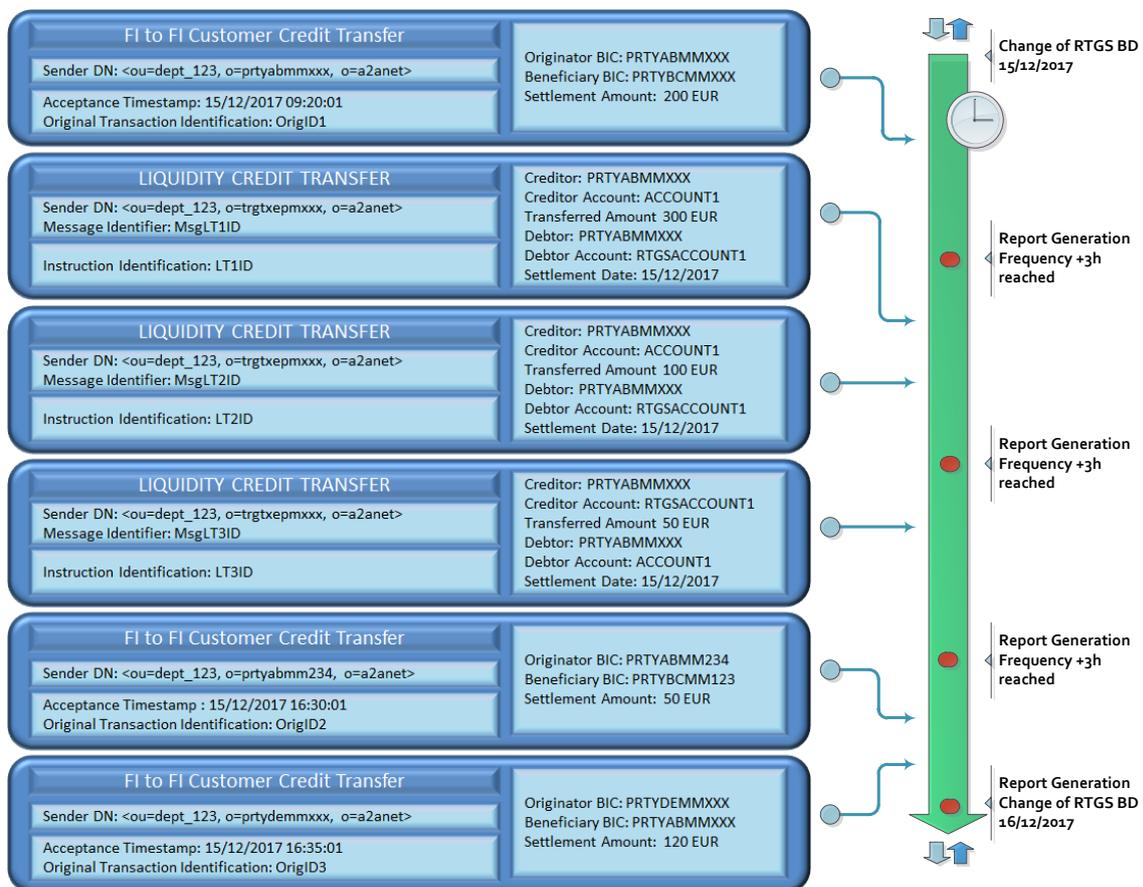

- The period of time configured in the report subscription (scheduled frequency: 3 hours) is elapsed from the last change of RTGS business date (15/12/2017);
- The system takes the snapshot of in-memory balances and downloads transaction data from the database;
- The Basic Report component retrieves the data to be included in the Statement of Accounts.
- The system identifies the Recipient DN from the "Routing Configuration" in combination with the "Party Technical Address" (<ou=dept_123, o=prtyabmmxxx, o=a2anet>);
- The Message Router component sends the following [BankToCustomerStatement](#) message to the Recipient.

Figure 211 – Statement of Accounts example: scheduled frequency n.1

| Bank To Customer Statement | |
|--|--|
| Sender DN: <ou=dept_123, o=tipsxepmxxx, o=a2anet> Message Identifier: MsgIDRptSoA15121710 Creation Date Time: 2017-12-15T10:01:00:000Z | |
| Statement Identifier: 1 ----- Account Identification: ACCOUNT1 Account Currency: EUR Account Owner: PRTYABMMXXX | Transaction Reference: OrigID1 Transaction Amount: 200 EUR Transaction Credit/Debit Indicator: DBIT Transaction Status: BOOK Settlement timestamp: 15/12/2017 09:20:05 Bank Transaction Code Family: IRCT Bank transaction code: PMNT Bank Transaction Code SubFamily: FICT |
| Balance Type: CLBD Amount: 300 EUR Credit/Debit Indicator: CRDT RTGS Business date: 15/12/2017 | Transaction Account Balance: 500 EUR Transaction Account Balance Type: BFTS ----- Transaction Account Balance: 300 EUR Transaction Account Balance Type: FTTS ----- Transaction Amount: 200 EUR Transaction Credit/Debit Indicator: DBIT Transaction Originator BIC: PRTYABMMXXX Transaction Beneficiary BIC: PRTYBCMMXXX |

- As shown in [Figure 210](#), the creation of the report is triggered other three times throughout the current RTGS business day. The last generation is activated by the RTGS business date update in TIPS (16/12/2017). The following messages are sent in chronological order by the Message Router to the Recipient.

Figure 212 – Statement of Accounts example: scheduled frequency n.2

| Bank To Customer Statement | | |
|--|--|--|
| Sender DN: <ou=dept_123, o=tipsxepmxxx, o=a2anet> Message Identifier: MsgIDRptSoA15121713 Creation Date Time: 2017-12-15T13:01:00:000Z | | |
| Statement Identifier: 1 ----- Account Identification: ACCOUNT1 Account Currency: EUR Account Owner: PRTYABMMXXX | Transaction Reference: LT1ID Transaction Amount: 300 EUR Transaction Credit/Debit Indicator: CRDT Transaction Status: BOOK Settlement timestamp: 15/12/2017 10:20:00 Bank Transaction Code Family: RCDT Bank transaction code: PMNT Bank Transaction Code SubFamily: FICT | Transaction Reference: LT2ID Transaction Amount: 100 EUR Transaction Credit/Debit Indicator: CRDT Transaction Status: BOOK Settlement timestamp: 15/12/2017 11:00:00 Bank Transaction Code Family: RCDT Bank transaction code: PMNT Bank Transaction Code SubFamily: FICT |
| Balance Type: CLBD Amount: 700 EUR Credit/Debit Indicator: CRDT RTGS Business date: 15/12/2017 | Transaction Account Balance: 300 EUR Transaction Account Balance Type: BFTS ----- Transaction Account Balance: 600 EUR Transaction Account Balance Type: FTTS ----- Transaction Amount: 300 EUR Transaction Credit/Debit Indicator: CRDT Transaction Originator BIC: PRTYABMMXXX Transaction Beneficiary BIC: PRTYABMMXXX | Transaction Account Balance: 600 EUR Transaction Account Balance Type: BFTS ----- Transaction Account Balance: 700 EUR Transaction Account Balance Type: FTTS ----- Transaction Amount: 100 EUR Transaction Credit/Debit Indicator: CRDT Transaction Originator BIC: PRTYABMMXXX Transaction Beneficiary BIC: PRTYABMMXXX |

Figure 213 – Statement of Accounts example: scheduled frequency n.3

| Bank To Customer Statement | |
|--|---|
| Sender DN: <ou=dept_123, o=tipsxepmxxx, o=a2anet> Message Identifier: MsgIDRptSoA15121716 Creation Date Time: 2017-12-15T16:01:00:000Z | |
| Statement Identifier: 1 ----- Account Identification: ACCOUNT1 Account Currency: EUR Account Owner: PRTYABMMXXX | Transaction Reference: LT3ID Transaction Amount: 50 EUR Transaction Credit/Debit Indicator: DBIT Transaction Status: BOOK Settlement timestamp: 15/12/2017 14:00:00 Bank Transaction Code Family: ICDT Bank transaction code: PMNT Bank Transaction Code SubFamily: FICT ----- Transaction Account Balance: 700 EUR Transaction Account Balance Type: BFTS ----- Transaction Account Balance: 650 EUR Transaction Account Balance Type: FTTS ----- Transaction Amount: 50 EUR Transaction Credit/Debit Indicator: DBIT Transaction Originator BIC: PRTYABMMXXX Transaction Beneficiary BIC: PRTYABMMXXX |
| Balance Type: CLBD Amount: 650 EUR Credit/Debit Indicator: CRDT RTGS Business date: 15/12/2017 | |

Figure 214 – Statement of Accounts example: scheduled frequency n.4

| Bank To Customer Statement | | |
|--|---|---|
| Sender DN: <ou=dept_123, o=tipsxepmxxx, o=a2anet> Message Identifier: MsgIDRptSoA15121719 Creation Date Time: 2017-12-15T19:01:00:000Z | | |
| Statement Identifier: 1 ----- Account Identification: ACCOUNT1 Account Currency: EUR Account Owner: PRTYABMMXXX | Transaction Reference: OrigID2 Transaction Amount: 50 EUR Transaction Credit/Debit Indicator: DBIT Transaction Status: BOOK Settlement timestamp: 15/12/2017 16:30:05 Bank Transaction Code Family: IRCT Bank transaction code: PMNT Bank Transaction Code SubFamily: FICT ----- Transaction Account Balance: 650 EUR Transaction Account Balance Type: BFTS ----- Transaction Account Balance: 600 EUR Transaction Account Balance Type: FTTS ----- Transaction Amount: 50 EUR Transaction Credit/Debit Indicator: DBIT Transaction Originator BIC: PRTYABMM234 Transaction Beneficiary BIC: PRTYBCMM123 | Transaction Reference: OrigID3 Transaction Amount: 120 EUR Transaction Credit/Debit Indicator: CRDT Transaction Status: BOOK Settlement timestamp: 15/12/2017 16:35:05 Bank Transaction Code Family: RRCT Bank transaction code: PMNT Bank Transaction Code SubFamily: FICT ----- Transaction Account Balance: 600 EUR Transaction Account Balance Type: BFTS ----- Transaction Account Balance: 720 EUR Transaction Account Balance Type: FTTS ----- Transaction Amount: 120 EUR Transaction Credit/Debit Indicator: CRDT Transaction Originator BIC: PRTYDEMMXXX Transaction Beneficiary BIC: PRTYABMMXXX |
| Balance Type: CLBD Amount: 720 EUR Credit/Debit Indicator: CRDT RTGS Business date: 15/12/2017 | | |

2.8.3. Report naming convention

TIPS supports production of the following reports whose naming convention is described below.

Table 72 – Report naming convention

| Report | Report Type ID | Format | Granularity |
|-------------------------------|--|-----------------------|--|
| Statement of Account Turnover | - SAT-F | XML (camt.052.001.06) | - Daily (at EOD) |
| Statement of Accounts | - SA-F - SA-D3 - SA-D6 - SA-D12 | XML (camt.053.001.06) | - Daily (at EOD) - Every 3 hours (from 00:00 UTC) and at EOD - Every 6 hours (from 00:00 UTC) and at EOD - Every 12 hours (from 00:00 UTC) and at EOD |

TIPS Directory (Full and Update version) is produced and delivered by CRDM. Therefore, it is no longer sent via the MEPT protocol.

Filenames and Message Business Identifiers⁵³ of reports are built as described below:

- Report File Name: `<reportType>_<partyId>_<dnId>_<sequence>.xml`
e.g. SAT-F_24r_P12_ab4.xml
- Message Business Identifier: `<reportType><partyId>-<dnId>-<sequence>`
e.g. SAT-F24r-P12-ab4

2.9. Reference data management

This section focuses on the management of the pieces of information that the user can amend with the functionalities available in TIPS (see [Table 15 – Reference data management functions available in TIPS](#) for references). Only the A2A aspects of these operations are described. The U2A details are described in the TIPS User Handbook.

The introductory part of the section presents the general flow, including all the steps, for the single possible operations (block/unblock of TIPS Participant, Ancillary System, Account or CMB, update of a CMB Limit).

⁵³ Filenames and Message Business Identifiers are of a merely technical nature, not fully open to user interpretation. For reasons of effectiveness, it is important to provide them as complementary information to the Operator when detecting functional or operational problems.

All the remaining sub-sections contain examples of the possible scenarios for each operation, starting from a successful one and detailing possible failure scenarios. Each example shows the relevant messages and how the main fields are filled.

Block/unblock of TIPS Participant or Ancillary System

The process covers the scenarios in which a Central Bank instructs the system in order to immediately block/unblock either a TIPS Participant or an Ancillary System for debiting and/or crediting operations. The involved actor is:

- The Central Bank starting the scenario and receiving the answer.

The involved messages are:

- The [PartyModificationRequest](#) message in order to request the block/unblock of the TIPS Actor;
- The [PartyStatusAdvice](#) message in order to report the successful or unsuccessful execution of the requested block/unblock operation.

Block/unblock of account/CMB

The process covers the scenarios in which:

- (i) a Central Bank instructs the system in order to immediately block/unblock an account/CMB for debiting and/or crediting operations or
- (ii) a TIPS Participant (optionally through its Instructing Party) or an Ancillary System instructs the system in order to immediately block/unblock a CMB for debiting and/or crediting operations.

In particular:

- Any TIPS Account or TIPS AS Technical Account can be blocked separately for debit only, credit only or both debit and credit;
- Any CMB can be blocked separately for headroom decrease, headroom increase or both.

The involved actors are:

- The Central Bank, the TIPS Participant (or optionally its Instructing Party) or the Ancillary System starting the scenario and receiving the answer.

The involved messages are:

- [AccountExcludedMandateMaintenanceRequest](#) message in order to request the block/unblock of the Account or CMB;
- [AccountRequestAcknowledgement](#) message in order to report the successful block/unblock operation;
- [AccountRequestRejection](#) message in order to report the unsuccessful block/unblock operation.

Update of a CMB Limit

The process covers the scenarios in which a TIPS Participant (optionally through its Instructing Party), an Ancillary System or a Central Bank instructs the system in order to immediately update a CMB Limit, increasing or decreasing it.

The involved actors are:

- The Central Bank, the TIPS Participant or the Ancillary System initiating the request and receiving the answer.

The involved messages are:

- [ModifyLimit](#) message in order to request the amendment of the CMB Limit;
- [Receipt \(camt.025.001.05\)](#) message in order to report the successful or unsuccessful execution of the requested update limit operation.

All the described scenarios are triggered under the assumption that the technical validation, check of mandatory fields and authentication of the user have already been successfully performed by ESMIG.

Below is the diagram describing the process and the involved actors. The details of the steps are described in the following [Table 73 – Block/unblock TIPS Actor](#) steps, [Table 74 – Block/unblock account/CMB steps](#) and [Table 75 – Update of a CMB Limit steps](#).

Figure 215 – Reference Data Messages flow

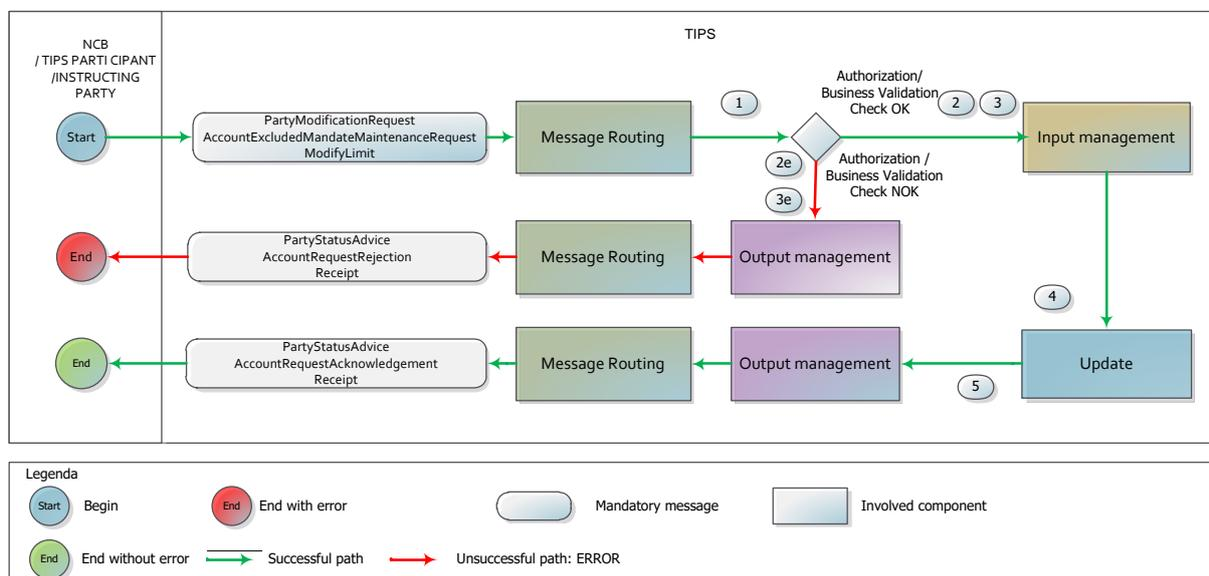

Table 73 – Block/unblock TIPS Actor steps

| Step | Involved messages | Involved actors | Description |
|------|--|--|---|
| 1 | PartyModificationRequest | Central Bank as sender TIPS as receiver | TIPS receives an incoming request for the amendment of a Party (block/unblock TIPS Actor ⁵⁴ for debit/credit or both) from the National Central Bank. Technical validation, check of mandatory fields and authentication checks have already been successfully executed. |
| 2 | | TIPS | TIPS successfully executes the checks: - Access Rights check ; - Duplicate check for local reference data transaction See 4.1- Business Rules for details. |
| 2e | PartyStatusAdvice | TIPS as sender Central Bank as receiver | TIPS unsuccessfully executes the check of step 2 . The system stops and sends a message to the Central Bank – same DN of the sender – containing the proper error code. |
| 3 | | TIPS | TIPS successfully executes the checks: - TIPS Actor block/unblock type allowed ; - Party existence ; - Party type allowed . See 4.1- Business Rules for details. |
| 3e | PartyStatusAdvice | TIPS as sender Central Bank as receiver | TIPS unsuccessfully executes one of the checks of step 3 . At the first negative check the system stops and sends a message to the Central Bank – same DN of the sender – containing the proper error code. See 4.1- Business Rules for details. |

⁵⁴ A TIPS Actor can be in this context either a TIPS Participant or an Ancillary System.

| Step | Involved messages | Involved actors | Description |
|------|-----------------------------------|--|---|
| 4 | | TIPS | <p>TIPS executes the requested operation.</p> <p>If the received message requests to insert a restriction, then:</p> <ul style="list-style-type: none"> - If the specified Restriction Type is “Block for credit”, the system sets the blocking status to “Blocked for credit” on the specified TIPS Actor data; - If the specified Restriction Type is “Block for debit”, the system sets the blocking status to “Blocked for debit” on the specified TIPS Actor data; - If the specified Restriction Type is “Block for both debit and credit”, the system sets the blocking status to “Blocked for both debit and credit” on the specified TIPS Actor data. <p>If the received message requests to remove a restriction:</p> <ul style="list-style-type: none"> - If the removed Restriction Type removed is “Block for credit”, the system sets the blocking status to “Unblocked for credit” on the specified TIPS Actor data; - If the removed Restriction Type is “Block for debit”, the system sets the blocking status to “unblocked for debit” on the specified TIPS Actor data; - If the removed Restriction Type is “Block for both debit and credit”, the system sets the blocking status to “Unblocked for both debit and credit” on the specified TIPS Actor data. |
| 5 | PartyStatusAdvice | TIPS as sender Central Bank as receiver | The system sends a message to the Central Bank – same DN of the sender – containing the proper information of successful execution. |

Table 74 – Block/unblock account/CMB steps

| Step | Involved messages | Involved actors | Description |
|------|---|--|---|
| 1 | AccountExcludedMandateMaintenance Request | Central Bank, TIPS Participant/Instructing Party or Ancillary System as sender TIPS as receiver | <p>TIPS receives an incoming request for the amendment of an Account (block/unblock account for debit/credit or both) from the National Central Bank or amendment of a CMB (block/unblock CMB for debit/credit or both) from either a TIPS Participant, an Ancillary System or a National Central Bank.</p> <p>Technical validation, check of mandatory fields and authentication checks have already been successfully executed.</p> |

| Step | Involved messages | Involved actors | Description |
|------|---|--|---|
| 2 | | TIPS | TIPS successfully executes the following check: - Access Rights check ; - Duplicate check for local reference data transaction . See 4.1- Business Rules for details. |
| 2e | AccountRequestRejection | TIPS as sender Central Bank, TIPS Participant/Instructing Party or Ancillary System as receiver | TIPS unsuccessfully executes the check of step 2 . The system stops and sends a message to the sender containing the proper error code. |
| 3 | | TIPS | TIPS successfully executes the checks: - Account/CMB block/unblock type allowed ; - Currency of the Account/CMB ; - Account/CMB existence ; - User allowed to block/unblock operation . See 4.1- Business Rules for details. |
| 3e | AccountRequestRejection | TIPS as sender Central Bank, TIPS Participant/Instructing Party or Ancillary System as receiver | TIPS unsuccessfully executes one of the checks of step 3 . At the first negative check the system stops and sends a message to the sender containing the proper error code. See 4.1- Business Rules for details. |

| Step | Involved messages | Involved actors | Description |
|------|---|---|---|
| 4 | | TIPS | <p>TIPS executes the requested operation.</p> <p>If the received message requests to insert a restriction:</p> <ul style="list-style-type: none"> - If the specified Restriction Type is “Block for credit”, the system sets the blocking status to “Blocked for credit” on the specified account or CMB data; - If the specified Restriction Type is “Block for debit”, the system sets the blocking status to “Blocked for debit” on the specified account or CMB data; - If the specified Restriction Type is “Block for both debit and credit”, the system sets the blocking status to “Blocked for both debit and credit” on the specified account or CMB data. <p>If the received message requests to remove a restriction:</p> <ul style="list-style-type: none"> - If the removed Restriction Type is “Block for credit”, the system sets the blocking status to “Unblocked for credit” on the specified account or CMB data; - If the removed Restriction Type is “Block for debit”, the system sets the blocking status to “Unblocked for debit” on the specified account or CMB data; - If the removed Restriction Type is “Block for both debit and credit”, the system sets the blocking status to “Unblocked for both debit and credit” on the specified account or CMB data. |
| 5 | AccountRequestAcknowledgement | <p>TIPS as sender</p> <p>Central Bank, TIPS Participant/Instructing Party or Ancillary System as receiver</p> | The system sends a message to the DN of the sender containing the proper information of successful execution. |

Table 75 – Update of a CMB Limit steps

| Step | Involved messages | Involved actors | Description |
|------|-----------------------------|---|--|
| 1 | ModifyLimit | <p>Central Bank, TIPS Participant/Instructing Party or Ancillary System as sender</p> <p>TIPS as receiver</p> | <p>TIPS receives an incoming request for the amendment of a CMB Limit from an authorised TIPS Actor.</p> <p>Technical validation, check of mandatory fields and authentication checks have already been successfully executed.</p> |

| Step | Involved messages | Involved actors | Description |
|------|---|--|---|
| 2 | | TIPS | TIPS successfully executes the checks: - Access Rights check ; - Duplicate check for local reference data transaction See 4.1- Business Rules for details. |
| 2e | Receipt (camt.025.001.05) | TIPS as sender Central Bank, TIPS Participant/Instructing Party or Ancillary System as receiver | TIPS unsuccessfully executes the check of step 2 . The system stops and sends a message to the sender containing the proper error code. |
| 3 | | TIPS | TIPS successfully executes the checks: - CMB existence ; - User allowed to change Limit . See 4.1- Business Rules for details. |
| 3e | Receipt (camt.025.001.05) | TIPS as sender Central Bank, TIPS Participant/Instructing Party or Ancillary System as receiver | TIPS unsuccessfully executes one of the checks of step 3 . At the first negative check the system stops and sends a message to the sender containing the proper error code. See 4.1- Business Rules for details. |
| 4 | | TIPS | TIPS executes the requested operation, setting the limit to the new value and adjusting the headroom accordingly. |
| 5 | Receipt (camt.025.001.05) | TIPS as sender Central Bank, TIPS Participant/Instructing Party or Ancillary System as receiver | The system sends a message to the DN of the sender containing the proper information of successful execution. |

2.9.1. Examples

This sub-section presents a non-exhaustive list of examples of the possible scenarios related to the Reference data management in A2A mode for each kind of operation.

The figure below summarises, for each reference data object mentioned in the following examples, the related configuration.

Figure 216 – Reference Data Management examples: data constellation

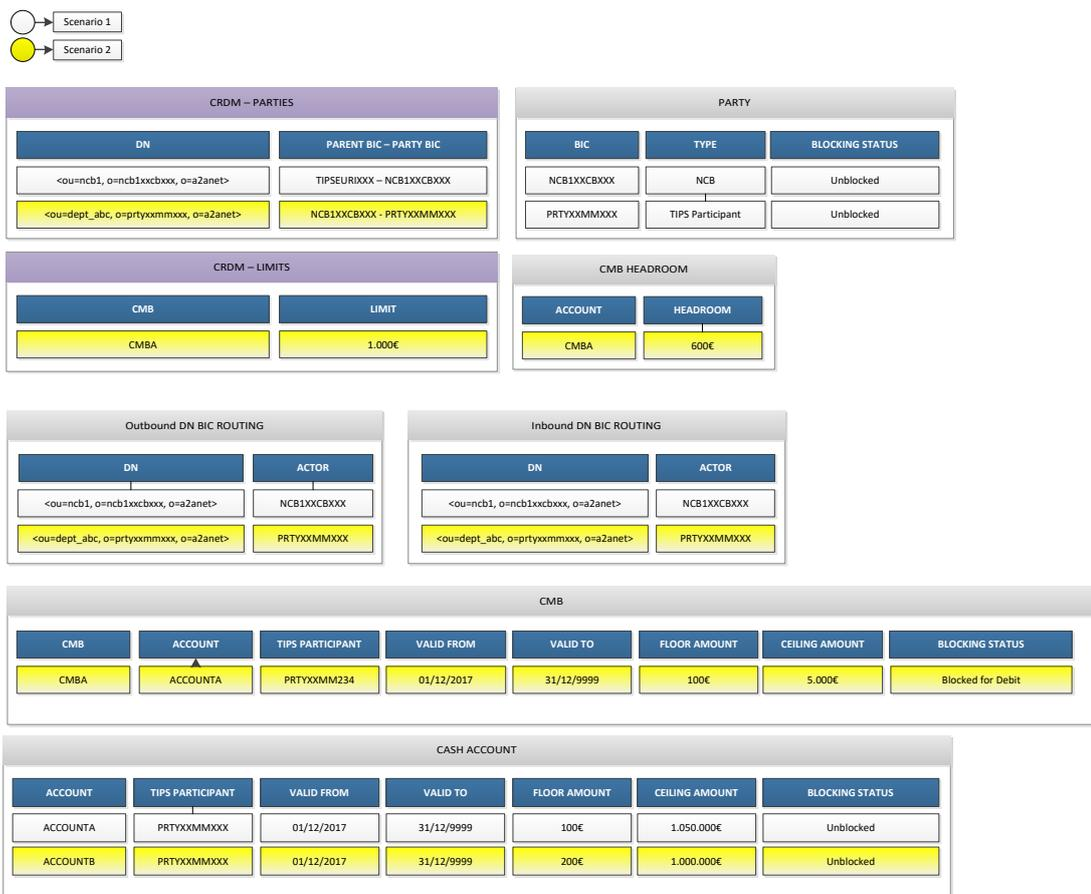

2.9.1.1. Successful scenario – Block of a TIPS Participant

In this positive scenario a Central Bank successfully blocks for debit a TIPS Participant. “Scenario 1” (white in the above table) is considered.

The [PartyModificationRequest](#) message received by TIPS and triggering the scenario looks like the following one.

Figure 217 – Successful block of a TIPS Participant: PartyModificationRequest

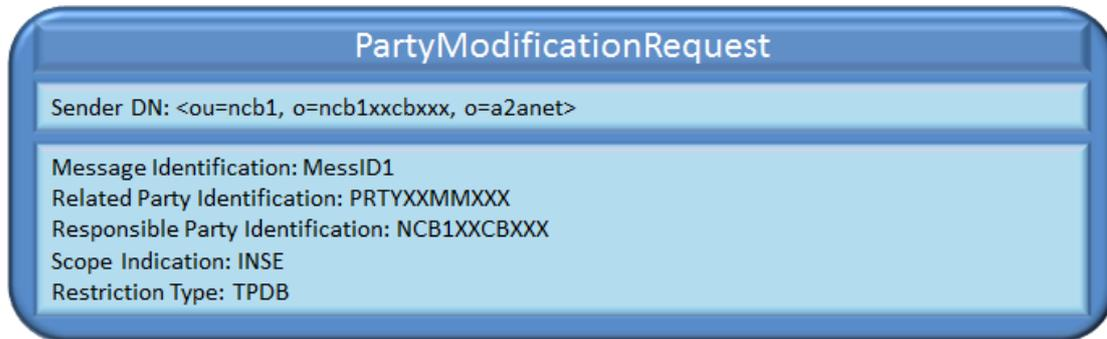

The system, after performing the expected checks successfully, performs the requested amendment:

- It identifies the TIPS Participant from the Related Party Identification (PRTYXXMMXXX);
- It identifies the type of block to be performed from the Restriction Type;
- It amends the TIPS Participant reporting the requested type of block.

Figure 218 – TIPS Participant blocked for debiting

| PARTY | | |
|-------------|------------------|-------------------|
| BIC | TYPE | BLOCKING STATUS |
| NCB1XXCBXXX | NCB | Unblocked |
| PRTYXXMMXXX | TIPS Participant | Blocked for debit |

After the amendment, TIPS sends a confirmation message to the Central Bank sending the request. The [PartyStatusAdvice](#) message sent by TIPS and triggering the scenario looks like the following one.

Figure 219 – Successful block of a TIPS Participant: PartyStatusAdvice

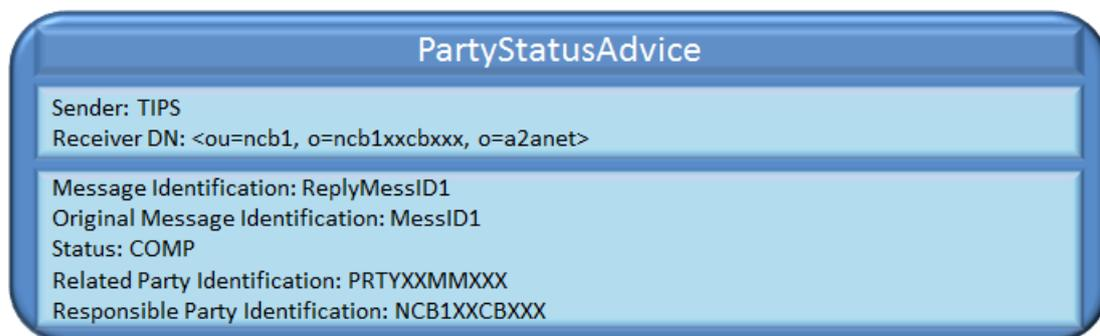

2.9.1.2. Successful scenario – Block of an Ancillary System

In this positive scenario a Central Bank successfully blocks for debit an Ancillary System.

The [PartyModificationRequest](#) message received by TIPS and triggering the scenario looks like the following one.

Figure 220 – Successful block of an Ancillary System: PartyModificationRequest



TIPS, after having performed successfully the expected checks on the message, executes the requested amendment:

- It identifies the Ancillary System from the Related Party Identification (ANSYPRMMXXX);
- It identifies the type of block to be performed from the Restriction Type;
- It updates the Ancillary System entities by applying the requested type of block.

Figure 221 – Ancillary System blocked for debiting

| PARTY | | |
|-------------|------------------|-------------------|
| BIC | TYPE | BLOCKING STATUS |
| NCB1XXCBXXX | NCB | Unblocked |
| ANSYPRMMXXX | Ancillary System | Blocked for debit |

After the amendment, TIPS sends a confirmation message to the Central Bank sending the request. The [PartyStatusAdvice](#) message sent by TIPS is shown in the following figure.

Figure 222 – Successful block of a TIPS Participant: PartyStatusAdvice

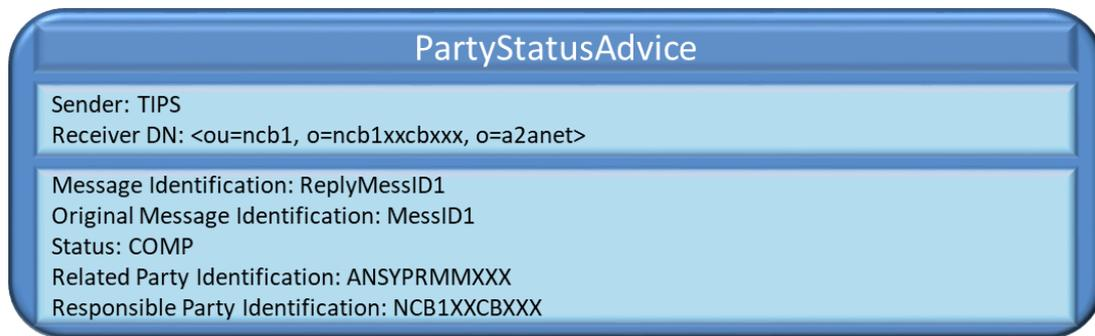

2.9.1.3. Successful scenario – Unblock of a TIPS Participant

In this positive scenario a Central Bank successfully unblocks a TIPS Participant. “Scenario 1” (highlighted in white in [Figure 216 – Reference Data Management examples: data constellation](#)) is considered.

No errors occur. The [PartyModificationRequest](#) message received by TIPS and triggering the scenario looks like the following one.

Figure 223 – Successful unblock of a TIPS Participant: PartyModificationRequest

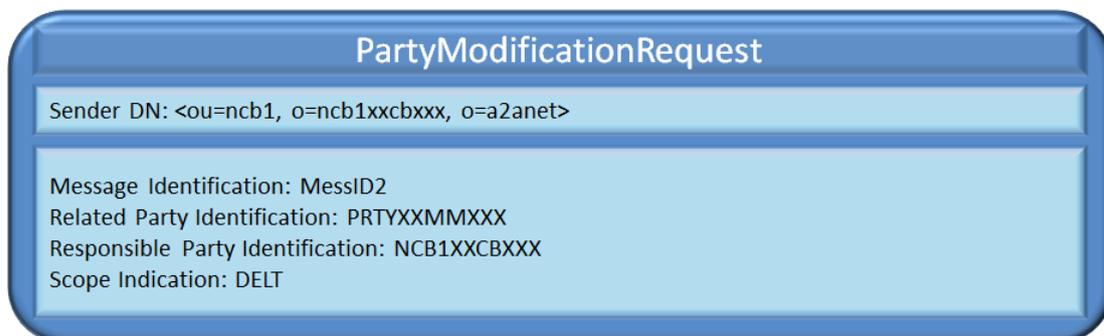

The system, after performing the expected checks successfully, performs the requested amendment:

- It identifies the TIPS Participant from the Related Party Identification (PRTYXXMMXXX);
- It identifies the type of block to be performed from the Restriction Type;
- It amends the TIPS Participant setting the party as unblocked.

Figure 224 – TIPS Participant unblocked

| PARTY | | |
|-------------|------------------|-----------------|
| BIC | TYPE | BLOCKING STATUS |
| NCB1XXCBXXX | NCB | Unblocked |
| PRTYXXMMXXX | TIPS Participant | Unblocked |

After the amendment, TIPS sends a confirmation message to the Central Bank sending the request. The [PartyStatusAdvice](#) message sent by TIPS and triggering the scenario looks like the following one.

Figure 225 – Successful unblock of a TIPS Participant: PartyStatusAdvice

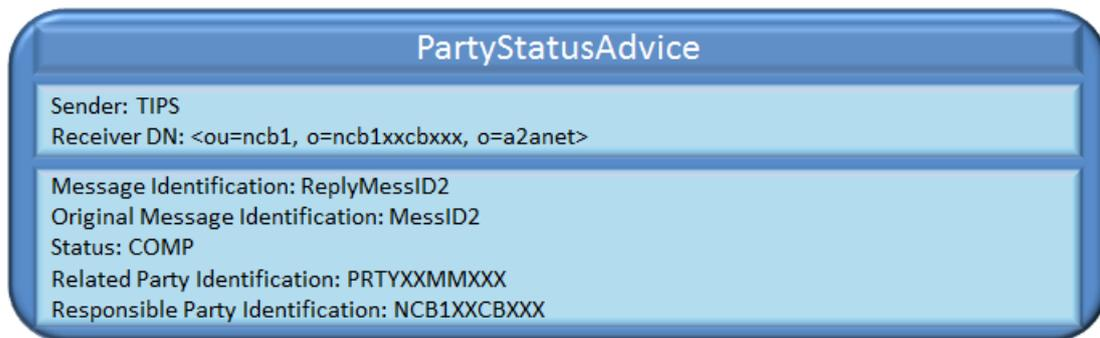

2.9.1.4. Unsuccessful scenario – Party not existing

In this negative scenario a Central Bank sends a message for blocking a TIPS Participant but the specified BIC does not match with a Participant in the TIPS reference data. “Scenario 1” (highlighted in white in [Figure 216 – Reference Data Management examples: data constellation](#)) is considered.

In this case, the system rejects the request since the referenced party does not exist. The [PartyModificationRequest](#) message received by TIPS and triggering the scenario looks like the following one.

Figure 226 – Unsuccessful block of a TIPS Participant: PartyModificationRequest

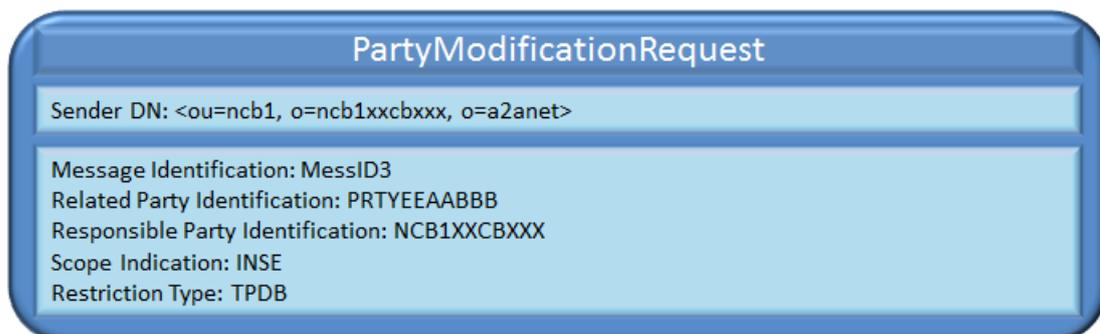

The system, when performing the expected checks, cannot find the referenced TIPS Participant and returns the related message. The [PartyStatusAdvice](#) message sent by TIPS and triggering the scenario looks like the following one:

Figure 227 – Successful block of a TIPS Participant: PartyStatusAdvice

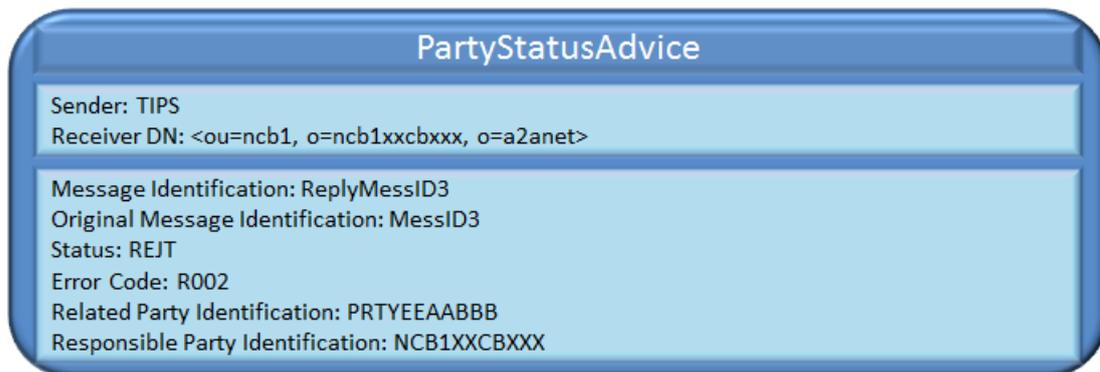

2.9.1.5. Successful scenario – Block of a CMB

In this positive scenario a TIPS Participant successfully blocks for both credit and debit a CMB. “Scenario 2” (highlighted in yellow in [Figure 216 – Reference Data Management examples: data constellation](#)) is considered.

No errors occur. The [AccountExcludedMandateMaintenanceRequest](#) message received by TIPS and triggering the scenario looks like the following one.

Figure 228 – Successful block of a CMB: AccountExcludedMandateMaintenanceRequest

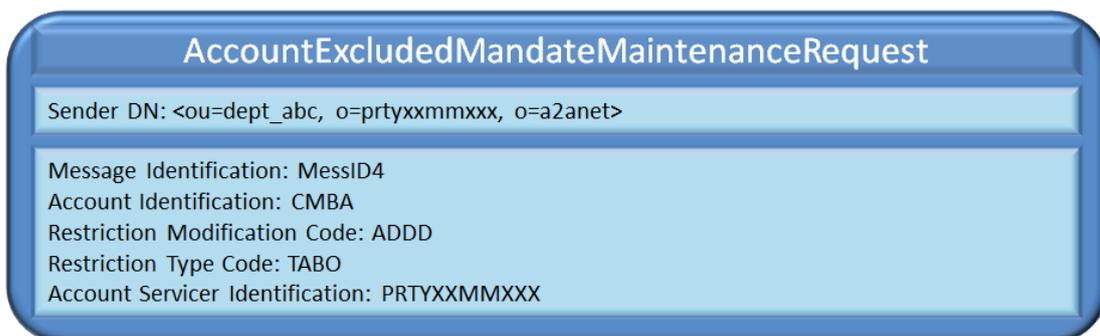

The system, after performing the expected checks successfully, performs the requested amendment:

- It identifies the CMB from the Account Identification;
- It identifies the type of block to be performed from the Restriction Type Code;
- It amends the CMB setting the requested type of block.

Figure 229 – CMB blocked for both credit and debit

| CMB | | | |
|------|----------|------------------|------------------------------|
| CMB | ACCOUNT | TIPS PARTICIPANT | BLOCKING STATUS |
| CMBA | ACCOUNTA | PRTYXXMM234 | Blocked for credit and debit |

After the amendment, TIPS sends a confirmation message to the TIPS Participant or Instructing Party sending the request. The [AccountRequestAcknowledgement](#) message sent by TIPS and triggering the scenario looks like the following one.

Figure 230 – Successful block of a CMB: AccountRequestAcknowledgement

| AccountRequestAcknowledgement |
|--|
| Sender: TIPS Receiver DN: <ou=dept_abc, o=prtyxxmmxxx, o=a2anet> |
| Message Identification: ReplyMessID4 Acknowledged Message Identification: MessID4 Status: COMP Account Identification: CMBA Account Servicer Identification: PRTYXXMMXXX |

2.9.1.6. Successful scenario – Unblock of an Account

In this positive scenario a Central Bank successfully unblocks an Account. “Scenario 1” and “Scenario 2” (highlighted in white and yellow in [Figure 216 – Reference Data Management examples: data constellation](#)) are considered.

No errors occur. The [AccountExcludedMandateMaintenanceRequest](#) message received by TIPS and triggering the scenario looks like the following one.

Figure 231 – Successful unblock of an Account: AccountExcludedMandateMaintenanceRequest

| AccountExcludedMandateMaintenanceRequest |
|--|
| Sender DN: <ou=ncb1, o=ncb1xxcbxxx, o=a2anet> |
| Message Identification: MessID5 Account Identification: AccountB Restriction Modification Code: DELE Account Servicer Identification: PRTYXXMMXXX |

The system, after performing the expected checks successfully, applies the requested amendment:

- It identifies the Account from the Account Identification;
- It amends the Account setting it as unblocked.

Figure 232 – Account unblocked

| CASH ACCOUNT | | |
|--------------|------------------|-----------------|
| ACCOUNT | TIPS PARTICIPANT | BLOCKING STATUS |
| ACCOUNTB | PRTYXXMMXXX | Unblocked |

After the amendment, TIPS sends a confirmation message to the TIPS Participant or Instructing Party sending the request. The [AccountRequestAcknowledgement](#) message sent by TIPS and triggering the scenario looks like the following one.

Figure 233 – Successful unblock of an Account: AccountRequestAcknowledgement

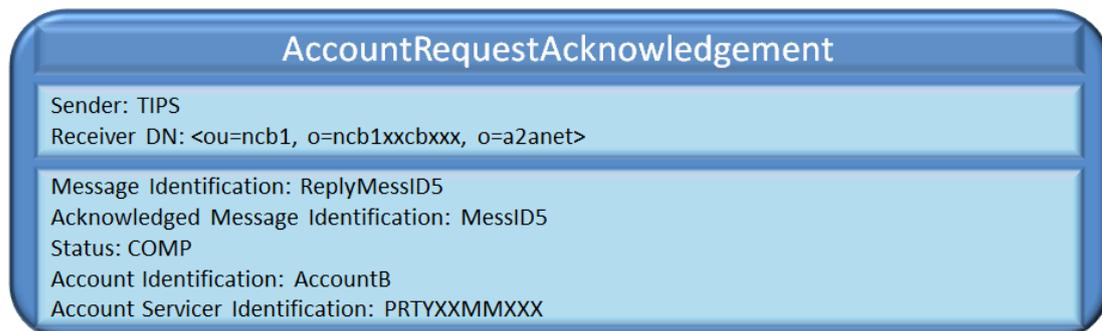

2.9.1.7. Unsuccessful scenario – Restriction type not allowed

In this negative scenario a TIPS Participant sends a message for blocking a CMB. The message contains a wrong reference to the type of blocking operation (e.g. 'TTTT' is an invalid Restriction Type Code) and an error is raised and notified. "Scenario 2" (highlighted in yellow in [Figure 216 – Reference Data Management examples: data constellation](#)) is considered.

The [AccountExcludedMandateMaintenanceRequest](#) message received by TIPS and triggering the scenario looks is described in the following figure.

Figure 234 – Unsuccessful block of a CMB: AccountExcludedMandateMaintenanceRequest

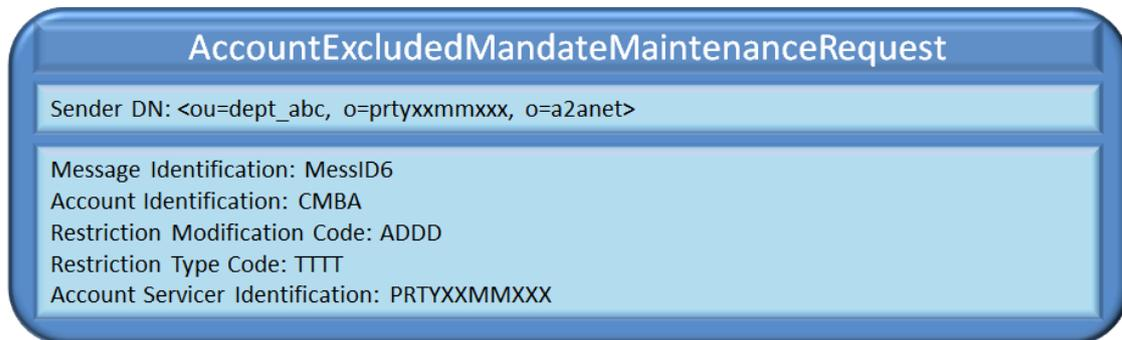

The system, when performing the expected checks, cannot identify the requested block type and consequently it raises the error (i.e. 'R005' - Restriction Type not allowed).

TIPS notifies the error with a rejection message to the TIPS Participant sending the request. The [AccountRequestRejection](#) message sent by TIPS and triggering the scenario looks like the following one.

Figure 235 – Unsuccessful block of a CMB: AccountRequestRejection

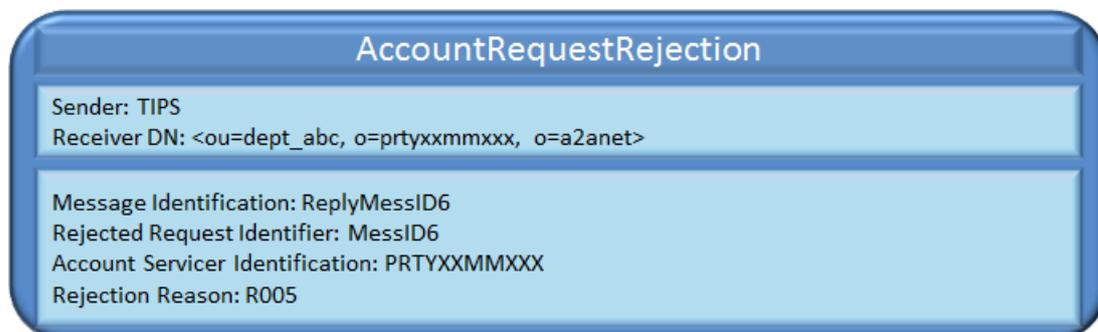

2.9.1.8. Successful scenario – Decrease of a CMB Limit

In this positive scenario a TIPS Participant successfully decreases the CMB Limit of a CMB under its data scope. "Scenario 2" (highlighted in yellow in [Figure 216 – Reference Data Management examples: data constellation](#)) is considered. The CMB Headroom is amended accordingly.

The [ModifyLimit](#) message received by TIPS and triggering the scenario looks like the following one:

Figure 236 – Successful decrease of a CMB Limit: ModifyLimit



The system, after performing the expected checks successfully, completes the requested amendment:

- It sets the new Limit for the CMB to 800.00 EUR;
- It amends the CMB Headroom decreasing it by the difference between the old limit value and the new limit value. In this example, the headroom of the CMB is 600.00 EUR and must be adjusted of 200.00 EUR (old limit 1,000.00 EUR – new limit 800.00 EUR) reaching the final value of 400.00 EUR.

Figure 237 – Successful decrease of a CMB Limit

| CMB change of limit | | | | |
|---------------------|-----------|-----------|--------------|--------------|
| CMB | OLD LIMIT | NEW LIMIT | OLD HEADROOM | NEW HEADROOM |
| CMBA | 1.000€ | 800€ | 600€ | 400€ |

After the amendment, TIPS sends a confirmation message to the TIPS Participant or Instructing Party sending the request. The [Receipt \(camt.025.001.05\)](#) message sent by TIPS and triggering the scenario looks like the following one.

Figure 238 – Successful decrease of a CMB Limit: Receipt



2.9.1.9. Unsuccessful scenario – User not allowed to change the Limit

In this negative scenario a TIPS Participant tries to decrease the CMB Limit of a CMB that does not fall under its data scope. “Scenario 2” (highlighted in yellow in [Figure 216 – Reference Data Management examples: data constellation](#)) is considered.

The system rejects the request and no actions are executed on the CMB.

The [ModifyLimit](#) message received by TIPS and triggering the scenario looks like the following one.

Figure 239 – Unsuccessful decrease of a CMB Limit: ModifyLimit



The system, performing the expected checks, verifies that the Account Owner is not correctly reported and it is not the owner of the CMB to be modified.

In this case, the system returns an error and sends a confirmation message to the TIPS Participant sending the request. The [Receipt \(camt.025.001.05\)](#) message sent by TIPS and triggering the scenario looks like the following one.

Figure 240 – Unsuccessful decrease of a CMB Limit: Receipt

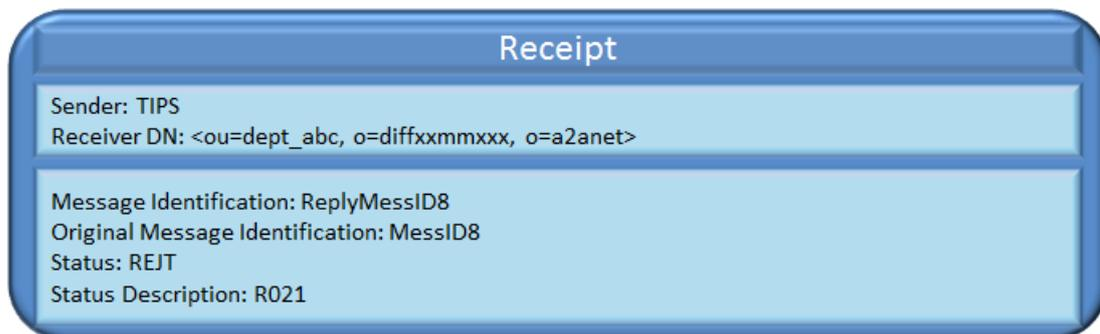

3. Catalogue of messages

This section aims at describing the detailed specifications of the A2A messaging resources used in TIPS. It is the reference guide for business readers checking the adherence to the SCT^{Inst} scheme and completeness of information to cover the business needs. Together with published XSD schemas, it is the reference guide for developing software components interacting with TIPS.

All of the messages are registered in ISO 20022 standards or have been submitted to the Registration Authority for starting the registration process.

3.1. Introduction

Following ISO 20022 business domains classification, messages from four different domains are used to cover the different business scenarios:

- Payments Clearing and Settlement
- Cash Management
- Account Management
- Reference Data

Payments Clearing and Settlement messages are used to adhere with SEPA SCT^{Inst} rulebook and Inter-PSP Guidelines. The description includes the related Data Source reference when available.

Cash Management messages are used to provide complete coverage for SEPA SCT^{Inst} investigation and recall processes as specified by the EPC SCT^{Inst} Scheme and to let users instruct liquidity transfers, query TIPS Accounts and CMBs balances and modify CMB limits.

Account Management messages are used to let users change the blocking status for TIPS Accounts or TIPS AS Technical Accounts.

Reference Data messages are used to let Central Banks change the blocking status for a TIPS Participant or an Ancillary System.

3.2. General information

A2A Interactions with TIPS are based on XML ISO 20022 standards as described in the EPC SCT^{Inst} Scheme.

The processing of the incoming XML messages is performed in different steps described in the following sections, which are not necessarily under TIPS responsibility.

3.2.1. Message signing

The message signature is handled in the ESMIG TIPS plug-in component. After successful validation, the ESMIG TIPS plug-in passes on to TIPS Message Router pieces of information that will be stored within TIPS repository, including sender's information and signature and technical network parameters, that would be required for Non-Repudiation of Origin (NRO) purposes.

No further processing but storing is performed in TIPS with such pieces of information.

3.2.2. Technical validation

Technical validation of incoming TIPS messages is performed in two different steps:

- 1) Schema validation;
- 2) Additional technical validation.

Both steps are performed within the ESMIG component. The schema validation is performed using standard parser components. Every message is validated against the published XSD subset for TIPS. The additional technical validation includes all of the checks which cannot be done in the schema validation with an automated parsing process (e.g. cross fields validation). They are performed only for messages which have passed the schema validation.

The type and quantity of the checks performed vary depending on the message type and on the SCT^{Inst} or ISO message constraints.

Rejection occurring for both schema validation and additional technical validation check is reported in the same way, that is with the same message type.

3.2.3. Supported Character Set

TIPS fully supports UTF-8 Character Set.

Following the SEPA Instant Credit Transfer specifications, the character set is restricted for references and identifiers to support the Latin characters which are commonly used in international communication.

The complete list is as follows:

a b c d e f g h i j k l m n o p q r s t u v w x y z
A B C D E F G H I J K L M N O P Q R S T U V W X Y Z
0 1 2 3 4 5 6 7 8 9
/ - ? : () . , ' + Space

As additional rules, it is required that references, identifications and identifiers must not start or end with '/' or contain '//'.

3.3. Messages usage

3.3.1. List of messages

In the following table, messages are grouped by ISO 20022 business domain.

Table 76 – List of messages for SCT^{Inst} scheme

| ISO Message | Message Name | Scenario |
|--|------------------------------|---|
| <u>Payments Clearing and Settlement</u> | | |
| pacs.002.001.10 | FIToFIPaymentStatusReport | Settlement of Instant Payments Settlement of Recall Investigation |
| pacs.004.001.09 | PaymentReturn | Settlement of Recall |
| pacs.008.001.08 | FIToFICustomerCreditTransfer | Settlement of Instant Payments |
| pacs.028.001.03 | FIToFIPaymentStatusRequest | Investigation and Recall |
| <u>Cash Management</u> | | |
| camt.003.001.06 | GetAccount | Reports and queries |
| camt.004.001.07 | ReturnAccount | Settlement of Instant Payments Settlement of Recall Liquidity Management Reports and queries |
| camt.005.001.07 | GetTransaction | Reports and queries |
| camt.006.001.07 | ReturnTransaction | Reports and queries |
| camt.011.001.07 | ModifyLimit | Reference data maintenance |
| camt.019.001.07 | ReturnBusinessDayInformation | Reports and queries |
| camt.025.001.05 | Receipt | Liquidity Management Reference data maintenance |
| camt.025.001.04 | Receipt | Communication with RTGS system |
| camt.029.001.09 | ResolutionOfInvestigation | Recall |
| camt.050.001.05 | LiquidityCreditTransfer | Liquidity Management |
| camt.052.001.06 | BankToCustomerAccountReport | Reports and queries |
| camt.053.001.06 | BankToCustomerStatement | Reports and queries |

| ISO Message | Message Name | Scenario |
|---|--|----------------------------|
| camt.053.001.08 | BankToCustomerStatement (General Ledger) | Reports and queries |
| camt.054.001.06 | BankToCustomerDebitCreditNotification | Liquidity Management |
| camt.056.001.08 | FIToFIPaymentCancellationRequest | Recall |
| <u>Account Management (acmt)</u> | | |
| acmt.010.001.02 | AccountRequestAcknowledgement | Reference data maintenance |
| acmt.011.001.02 | AccountRequestRejection | Reference data maintenance |
| acmt.015.001.02 | AccountExcludedMandateMaintenanceRequest | Reference data maintenance |
| <u>Reference Data (reda)</u> | | |
| reda.016.001.01 | PartyStatusAdvice | Reference data maintenance |
| reda.022.001.01 | PartyModificationRequest | Reference data maintenance |

Table 77 – List of messages for non-Euro schemes

| ISO Message | Message Name | Scenario |
|--|------------------------------|---|
| <u>Payments Clearing and Settlement</u> | | |
| pacs.002.001.10 | FIToFIPaymentStatusReport | Settlement of Instant Payments Settlement of Recall Investigation |
| pacs.004.001.09 | PaymentReturn | Settlement of Recall |
| pacs.008.001.08 | FIToFICustomerCreditTransfer | Settlement of Instant Payments |
| pacs.028.001.03 | FIToFIPaymentStatusRequest | Investigation and Recall |
| <u>Cash Management</u> | | |
| camt.003.001.06 | GetAccount | Reports and queries |

| ISO Message | Message Name | Scenario |
|----------------------------------|--|---|
| camt.004.001.07 | ReturnAccount | Settlement of Instant Payments Settlement of Recall Liquidity Management Reports and queries |
| camt.005.001.07 | GetTransaction | Reports and queries |
| camt.006.001.07 | ReturnTransaction | Reports and queries |
| camt.011.001.07 | ModifyLimit | Reference data maintenance |
| camt.019.001.07 | ReturnBusinessDayInformation | Reports and queries |
| camt.025.001.05 | Receipt | Liquidity Management Reference data maintenance |
| camt.025.001.04 | Receipt | Communication with RTGS system |
| camt.029.001.09 | ResolutionOfInvestigation | Recall |
| camt.050.001.05 | LiquidityCreditTransfer | Liquidity Management |
| camt.052.001.06 | BankToCustomerAccountReport | Reports and queries |
| camt.053.001.06 | BankToCustomerStatement | Reports and queries |
| camt.053.001.08 | BankToCustomerStatement (General Ledger) | Reports and queries |
| camt.054.001.06 | BankToCustomerDebitCreditNotification | Liquidity Management |
| camt.056.001.08 | FIToFIPaymentCancellationRequest | Recall |
| Account Management (acmt) | | |
| acmt.010.001.02 | AccountRequestAcknowledgement | Reference data maintenance |
| acmt.011.001.02 | AccountRequestRejection | Reference data maintenance |
| acmt.015.001.02 | AccountExcludedMandateMaintenanceRequest | Reference data maintenance |
| Reference Data (reda) | | |
| reda.016.001.01 | PartyStatusAdvice | Reference data maintenance |
| reda.022.001.01 | PartyModificationRequest | Reference data maintenance |

3.3.2. Messages description

3.3.2.1. Payments Clearing and Settlement

3.3.2.1.1 FIToFIPaymentStatusReport (pacs.002.001.10)

The FIToFIPaymentStatusReport message is used in several business cases

1. It is sent by TIPS to the Originator Participant to report a rejection for a pacs.008 transaction;
2. It is sent by the Beneficiary Participant or Instructing Party to TIPS to report the processing result of a pacs.008 sent by TIPS upon request of an Originator Participant;
3. The message as received by the Beneficiary Participant is forwarded to the Originator Participant. This scenario covers also the positive response to a Status Investigation request;
4. It is sent by TIPS to the Beneficiary Participant as a confirmation for processing of the pacs.002 received from the Beneficiary Participant itself;
5. It is sent by TIPS to the Originator Participant after a negative response to a Status Investigation request.
6. It is sent by TIPS to the Originator Participant (e.g., in case of errors during the conditional phase or in case of timeout condition triggered by TIPS during either the conditional phase or settlement phase);
7. It is sent by TIPS to the sender of the Recall in case of errors;
8. It is sent by TIPS to the sender of the positive Recall Response either as a positive settlement confirmation or in case of errors (e.g. not sufficient funds to settle the positive recall or validation error related to the Recall Response);
9. It is sent by TIPS to the sender of the negative Recall Response in case of errors (e.g. missing access rights);
10. It is sent by TIPS to inform the Single Instructing Party about the result of the settlement (i.e. settled, rejected, timed-out) in the SIP settlement model;
11. It is sent by TIPS to the Beneficiary Participant in case of timeout condition triggered by TIPS during the settlement phase due to missing positive confirmation from the Beneficiary Participant;
12. It is sent by TIPS to the Beneficiary Participant in case of timeout condition triggered by TIPS during the settlement phase due to delayed positive confirmation from the Beneficiary Participant.

Message specification is compliant to EPC DS-03 Confirmation Message as described in the SEPA Instant Credit Transfer scheme Rulebook.

References/links

The schema and the related documentation in XSD/EXCEL/PDF format as well as the message examples are provided within the MyStandards repository under the following link:

<https://www.swift.com/mystandards/TIPS/pacs.002.001.10>

Table 78 – Description of the fields for DS-03 Dataset vs pacs.002.001.10

| EPC Ref. | Reference Name | EPC/ISO Description | XML path | Mand. | TIPS Usage |
|----------|---------------------------------|---|--|-------|--|
| n/a | Message Identification | The Identification of the message. | FIToFIPmtStsRpt/GrpHdr/Msgld | Yes | Only schema validation is performed. |
| n/a | Creation Date Time | Date and time at which the message was created. | FIToFIPmtStsRpt/GrpHdr/CreDtTm | Yes | Only schema validation is performed. |
| n/a | Instructing Agent | Agent that instructs the next party in the chain to carry out the instruction. | FIToFIPmtStsRpt/GrpHdr/InstgAgt | No | Only schema validation is performed. |
| n/a | Instructed Agent | Agent that is instructed by the previous party in the chain to carry out the instruction. | FIToFIPmtStsRpt/GrpHdr/InstdAgt | No | Only schema validation is performed. |
| n/a | Original Message Identification | Message Identification of the originating message | FIToFIPmtStsRpt/OrgnlGrpInfAndSts/OrgnlMsgld | Yes | <p>This field matches with the Identification of the original message.</p> <p>Business cases 1,2,3,6,10,11: FIToFICstmrCdtTrf/GrpHdr/Msgld</p> <p>Business case 4,12: FIToFIPmtStsRpt/GrpHdr/Msgld</p> <p>Business case 5: FIToFIPmtStsReq/GrpHdr/Msgld</p> <p>Business case 7: FIToFIPmtCxlReq/Assgnmt/ld</p> <p>Business case 8: PmtRtr/GrpHdr/Msgld</p> <p>Business case 9: RsItntOfInvstgtn/Assgnmt/ld</p> |

| EPC Ref. | Reference Name | EPC/ISO Description | XML path | Mand. | TIPS Usage |
|--------------------|--------------------------------------|---|--|-------|---|
| n/a | Original Message Name Identification | Message identifier of the originating message. SEPA usage rule: Only pacs.008.001.08 is allowed. | FItoFIPmtStsRpt/Orgnl GrpInfAndSts/OrgnlMsg Nmld | Yes | Business cases 1,2,3, 6,10,11 ⁵⁵ : pacs.008.001.08 or pacs.008.001.02 Business cases 4,12: pacs.002.001.10 Business case 5: pacs.028.001.03 Business case 7: camt.056.001.08 Business case 8: pacs.004.001.09 Business case 9: camt.029.001.09 SEPA usage rule applicable only to business cases 2, 3 |
| AT-R001 | Group Status Transaction Status | The type of "R" message | FItoFIPmtStsRpt/Orgnl GrpInfAndSts/GrpSts FItoFIPmtStsRpt/TxInfAndSts/TxSts | No | Either Group Status or Transaction Status must be used. If incoming pacs.002 from beneficiary does not include any status or both are filled in, connected payment transaction will be rejected by TIPS. In outgoing pacs.002 messages produced by TIPS, Group Status will be used for positive confirmation while Transaction Status will be included for negative acknowledgements, |
| AT-R004 | Reason | The reason code for non-acceptance of the SCT ^{Inst} Transaction | FItoFIPmtStsRpt/Orgnl GrpInfAndSts/StsRsnInf/Rsn/Cd | No | This field is used for negative confirmation message only. |
| n/a | Transaction Information And Status | Information concerning the original transactions, to which the status report message refers. | FItoFIPmtStsRpt/TxInfAndSts | No | Only one occurrence is allowed |
| AT-R003 AT-T055 | Status Identification | The specific reference of the party initiating the Reject | FItoFIPmtStsRpt/TxInfAndSts/StsId | Yes | For positive confirmation it is the AT-T055. For negative confirmation it is the AT-R003 |
| n/a | Original Instruction Identification | Unique identification, as assigned by the original Instructing Party for the original instructed party. | FItoFIPmtStsRpt/TxInfAndSts/OrgnlInstrld | No | Only schema validation is performed. |
| AT-T014 | Original End To End Identification | The Originator's reference of the SCT ^{Inst} Transaction | FItoFIPmtStsRpt/TxInfAndSts/OrgnlEndToEndId | Yes | Only schema validation is performed. |

⁵⁵ For all business cases in which the message is generated by TIPS, the Original Message Name Identification in line with the 2019 message version of ISO 20022 is provided. For all the other business cases, the usage of the correct Original Message Name Identification, in relation to the moment in which the original message was sent in reference to the migration date to the 2019 message version of ISO 20022, should be ensured by the actor who sends the message to TIPS: no check on the correspondence of this value with respect to the version of the original message is performed by TIPS.

| EPC Ref. | Reference Name | EPC/ISO Description | XML path | Mand. | TIPS Usage |
|----------|-------------------------------------|--|---|-------|--|
| AT-T054 | Original Transaction Identification | The Originator PSP's reference number of the SCT ^{Inst} Transaction message | FItoFIPmtStsRpt/TxInfAndSts/OrgnlTxId | Yes | Reference of the Payment Transaction to which the PaymentStatusReport refers. |
| AT-R002 | Originator | The Identification of the type of party initiating the "R" message | FItoFIPmtStsRpt/OrgnlGrpInfAndSts/StsRsnInf/Orgtr FItoFIPmtStsRpt/TxInfAndSts/StsRsnInf/Orgtr | No | These fields are mandatory for negative confirmation message, not allowed otherwise. |
| AT-R004 | Reason | The reason code for non-acceptance of the SCT ^{Inst} Transaction | FItoFIPmtStsRpt/TxInfAndSts/StsRsnInf/Rsn/Cd | No | This field is used for negative confirmation message only. |
| AT-T056 | Acceptance Timestamp | Time Stamp of the SCT ^{Inst} Transaction | FItoFIPmtStsRpt/TxInfAndSts/AcceptncDtTm | Yes | Only schema validation is performed. |
| n/a | Original Transaction Reference | Set of key elements used to identify the original transaction that is being referred to. | FItoFIPmtStsRpt/TxInfAndSts/OrgnlTxRef | Yes | Only schema validation is performed. |
| AT-T001 | Scheme Identification Code | The identification code of the SCT ^{Inst} Scheme | FItoFIPmtStsRpt/TxInfAndSts/OrgnlTxRef/PmtTpInf/SvcLvl/Cd FItoFIPmtStsRpt/TxInfAndSts/OrgnlTxRef/PmtTpInf/LclInstrm/Cd | Yes | Possible values are checked within schema validation. |
| AT-T008 | Category Purpose | The category purpose of the SCT ^{Inst} Instruction | FItoFIPmtStsRpt/TxInfAndSts/OrgnlTxRef/PmtTpInf/CtgyPurp | No | Only schema validation is performed. |
| AT-D002 | Originator BIC | The BIC code of the Originator PSP | FItoFIPmtStsRpt/TxInfAndSts/OrgnlTxRef/DbtrAgt/FinInstnld/BICFI | Yes | |

3.3.2.1.2 PaymentReturn (pacs.004.001.09)

The PaymentReturn message is sent by the Assignee Participant as a confirmation for a Recall instructed by the Assigner Participant.

Additionally, the PaymentReturn message can be sent in reply to a Request for Status Update on a Recall.

After processing the request, TIPS forwards the PaymentReturn message to the Assigner Participant who formerly instructed the Recall and sends a PaymentStatusReport message to the Assignee Participant.

Message specification is compliant to EPC DS-06 Response to a Recall of an SCT^{Inst} Dataset as described in the SEPA Instant Credit Transfer scheme Rulebook.

References/links

The schema and the related documentation in XSD/EXCEL/PDF format as well as the message examples are provided within the MyStandards repository under the following link:

<https://www.swift.com/mystandards/TIPS/pacs.004.001.09>

Table 79 – Description of the fields for DS-06 Dataset vs pacs.004.001.09

| EPC Ref. | Reference Name | EPC/ISO Description | XML path | Mand. | TIPS Usage |
|----------|--|---|-------------------------------------|-------|--|
| n/a | Message Identification | The Identification of the message. | PmtRtr/GrpHdr/MsgId | Yes | Only schema validation is performed. |
| n/a | Creation Date Time | Date and time at which the message was created. | PmtRtr/GrpHdr/CreDtTm | Yes | Only schema validation is performed. |
| n/a | Number Of Transactions | Number of individual transactions contained in the message. | PmtRtr/GrpHdr/NbOfTx | Yes | TIPS supports only one transaction per message. If this field is not "1", message will be rejected. |
| n/a | Total Returned Interbank Settlement Amount | Total amount of money moved. | PmtRtr/GrpHdr/TtlRtrdlntrBkSttlmAmt | Yes | Only schema validation is performed. |
| AT-R056 | Interbank Settlement Date | The Settlement Date for the positive response to the Recall | PmtRtr/GrpHdr/IntrBkSttlmDt | Yes | Only schema validation is performed. |
| n/a | Settlement Method | Method used to settle the Instant Payment Transaction. | PmtRtr/GrpHdr/SttlmInf/SttlmMtd | Yes | Possible values are checked within schema validation. |
| n/a | Settlement Account | A specific purpose account used to post debit and credit entries as a result of the transaction. | PmtRtr/GrpHdr/SttlmInf/SttlmAcct | No | Only schema validation is performed. |
| n/a | Clearing System | Specification of a pre-agreed offering between clearing agents or the channel through which the Instant Payment transaction is processed. | PmtRtr/GrpHdr/SttlmInf/ClrSys | No | Only schema validation is performed. |
| n/a | Group Header +Settlement Information ++Clearing System +++Code | Infrastructure through which the payment instruction is processed, as published in an external clearing system identification code list. | PmtRtr/GrpHdr/SttlmInf/ClrSys/Cd | Yes | Only schema validation is performed. |
| n/a | Group Header +Settlement Information ++Clearing System +++Proprietary | Clearing system identification in a proprietary form. | PmtRtr/GrpHdr/SttlmInf/ClrSys/Prtry | Yes | Only schema validation is performed. |
| n/a | Instructing Agent | Agent that instructs the next party in the chain to carry out the instruction. | PmtRtr/GrpHdr/InstgAgt | No | Only schema validation is performed. |
| n/a | Instructed Agent | Agent that is instructed by the previous party in the chain to carry out the instruction. | PmtRtr/GrpHdr/InstdAgt | No | Only schema validation is performed. |
| n/a | Original Group Information | Information concerning the original group of transactions, to which the message refers. | PmtRtr/OrgnlGrpInf | No | Sub-elements of 'Original Group Information' must be present in either 'Original Group Information' or in 'Transaction Information'. If any of these sub-elements is included in both components, the message will be rejected. |

| EPC Ref. | Reference Name | EPC/ISO Description | XML path | Mand. | TIPS Usage |
|----------|---|---|-------------------------------------|-------|--|
| n/a | Original Group Information + Original Message Identification | Point to point reference, as assigned by the original instructing party, to unambiguously identify the original message. | PmtRtr/OrgnlGrpInf/OrgnlMsgld | Yes | This information must be present in either 'Original Group Information' or in 'Transaction Information'. If it is included in both components, message will be rejected. |
| n/a | Original Group Information + Original Message Name Identification | Specifies the original message name identifier to which the message refers. Allowed values ⁵⁶ : pacs.008.001.08 or pacs.008.001.02 . | PmtRtr/OrgnlGrpInf/OrgnlMsgNmld | Yes | This information must be present in either 'Original Group Information' or in 'Transaction Information'. If it is included in both components, message will be rejected. |
| n/a | Transaction Information | Information concerning the original transactions to which the return message refers. | PmtRtr/TxInf | Yes | TIPS supports only one transaction per message. If more than one Transaction Information block is included, message will be rejected. |
| n/a | Return Identification | Unique identification, as assigned by an instructing party for an instructed party, to unambiguously identify the returned transaction. | PmtRtr/TxInf/Rtrld | Yes | TIPS uses this field for the duplicate check. |
| n/a | Transaction Information + Original Group Information | Information concerning the original group of transactions, to which the message refers. | PmtRtr/TxInf/OrgnlGrpInf | No | Sub-elements of 'Original Group Information' must be present in either 'Original Group Information' or in 'Transaction Information'. If any of these sub-elements is included in both components, message will be rejected. |
| n/a | Transaction Information + Original Group Information ++ Original Message Identification | Point to point reference, as assigned by the original instructing party, to unambiguously identify the original message. | PmtRtr/TxInf/OrgnlGrpInf/OrgnlMsgld | Yes | This information must be present in either 'Original Group Information' or in 'Transaction Information'. If it is included in both components, message will be rejected. |

⁵⁶ The usage of the correct Original Message Name Identification, in relation to the moment in which the original message was sent in reference to the migration date to the 2019 message version of ISO 20022, should be ensured by the actor who generates and sends the message to TIPS: no check on the correspondence of this value with respect to the version of the original message is performed by TIPS.

| EPC Ref. | Reference Name | EPC/ISO Description | XML path | Mand. | TIPS Usage |
|----------|--|---|---------------------------------------|-------|---|
| n/a | Transaction Information + Original Group Information ++ Original Message Name Identification | Specifies the original message name identifier to which the message refers. Allowed values ⁵⁷ : pacs.008.001.08 or pacs.008.001.02 . | PmtRtr/TxInf/OrgnlGrplnf/OrgnlMsgNmld | Yes | This information must be present in either 'Original Group Information' or in 'Transaction Information'. If it is included in both components, message will be rejected. |
| n/a | Original Instruction Identification | Unique identification, as assigned by the original instructing party for the original instructed party, to unambiguously identify the original instruction. | PmtRtr/TxInf/OrgnlInstrld | No | It is mandatory if provided in the original transaction. Only schema validation is performed. |
| AT-T014 | Original End To End Identification | The Originator's reference of the SCT ^{Inst} Instruction. | PmtRtr/TxInf/OrgnlEndT oEndld | Yes | Only schema validation is performed. |
| AT-T054 | Original Transaction Identification | The Originator PSP's reference of the SCT ^{Inst} Transaction message. | PmtRtr/TxInf/OrgnlTxld | Yes | Only schema validation is performed. |
| AT-T002 | Original Interbank Settlement Amount | The amount of the SCT ^{Inst} in euro. | PmtRtr/TxInf/OrgnlIntrBk SttlmAmt | Yes | Only schema validation is performed. |
| AT-R054 | Returned Interbank Settlement Amount | The returned amount of the positive response to the Recall in euro | PmtRtr/TxInf/RtrdIntrBk SttlmAmt | Yes | Amount to be settled in TIPS. |
| n/a | Returned Instructed Amount | Amount of money to be moved between the debtor and the creditor, before deduction of charges, in the returned transaction. | PmtRtr/TxInf/RtrdInstdA mt | No | Only schema validation is performed. |
| n/a | Charge Bearer | Specifies which party/parties will bear the charges associated with the processing of the payment transaction. | PmtRtr/TxInf/ChrgBr | No | Only schema validation is performed. |
| AT-R055 | Charges Information + Amount | The fee for the positive response to a Recall in euro (optional) | PmtRtr/TxInf/ChrgsInf/a mt | No | It is mandatory if Charges Information component is included. Only schema validation is performed. |
| AT-C002 | Charges Information + Agent ++ Financial Institution Identification | The BIC code of the Beneficiary PSP. | PmtRtr/TxInf/ChrgsInf/A gt/FinInstnld | No | It is mandatory if Charges Information component is included. Only schema validation is performed. |
| n/a | Transaction Information + Instructing Agent | Agent that instructs the next party in the chain to carry out the instruction. | PmtRtr/TxInf/InstgAgt | No | Only schema validation is performed. |
| n/a | Transaction Information + Instructed Agent | Agent that is instructed by the previous party in the chain to carry out the instruction. | PmtRtr/TxInf/InstdAgt | No | Only schema validation is performed. |
| AT-R001 | | The type of "R" message | | | |
| AT-R002 | Return Reason Information + Originator | The Identification of the type of party initiating the "R" message | PmtRtr/TxInf/RtrRsnInf/ Orgtr | Yes | Only schema validation is performed. |

⁵⁷ The usage of the correct Original Message Name Identification, in relation to the moment in which the original message was sent in reference to the migration date to the 2019 message version of ISO 20022, should be ensured by the actor who generates and sends the message to TIPS: no check on the correspondence of this value with respect to the version of the original message is performed by TIPS.

| EPC Ref. | Reference Name | EPC/ISO Description | XML path | Mand. | TIPS Usage |
|----------|--|---|---|-------|--|
| n/a | Return Reason Information + Reason | The reason code for non-acceptance of the SCT ^{Inst} Transaction. | PmtRtr/TxInf/RtrRsnInf/Rsn/Cd | Yes | Only schema validation is performed. |
| AT-R053 | Return Reason Information + Additional Information | The specific reference of the PSP initiating the Recall | PmtRtr/TxInf/RtrRsnInf/addtlInf | Yes | Only schema validation is performed. |
| AT-T051 | Interbank Settlement Date | The Settlement Date of the SCT ^{Inst} Transaction. | PmtRtr/TxInf/OrgnITxRef/IntrBkSttlmDt | No | Only schema validation is performed. |
| n/a | Settlement Information | Specifies the details on how the settlement of the original transaction between the instructing agent and the instructed agent was completed. | PmtRtr/TxInf/OrgnITxRef/SttlmInf | No | Only schema validation is performed. |
| AT-T001 | Scheme Identification Code | The identification code of the SCT ^{Inst} Scheme | PmtRtr/TxInf/OrgnITxRef/PmtTpInf/SvcLvl/Cd PmtRtr/TxInf/OrgnITxRef/PmtTpInf/LclInstrm/Cd | No | Only schema validation is performed. |
| AT-T008 | Category Purpose | The category purpose of the SCT ^{Inst} Instruction. | PmtRtr/TxInf/OrgnITxRef/PmtTpInf/CtgyPurp | No | Only schema validation is performed. |
| AT-T009 | Remittance Information | The Remittance information. | PmtRtr/TxInf/OrgnITxRef/RmtInf | No | Only schema validation is performed. |
| AT-P006 | Ultimate Debtor + Name | The name of the Originator Reference Party. | PmtRtr/TxInf/OrgnITxRef/UltmtDbtr/Pty/Nm | No | Only schema validation is performed. |
| AT-P007 | Ultimate Debtor + Identification | The identification code of the Originator Reference Party. | PmtRtr/TxInf/OrgnITxRef/UltmtDbtr/Pty/Id | No | Only schema validation is performed. |
| AT-P001 | Debtor + Name | The name of the Originator. | PmtRtr/TxInf/OrgnITxRef/Dbtr/Pty/Nm | No | Only schema validation is performed. |
| AT-P005 | Debtor + Postal Address | The address of the Originator. | PmtRtr/TxInf/OrgnITxRef/Dbtr/Pty/PstlAdr | No | Only schema validation is performed. |
| AT-P004 | Debtor + Identification | The Originator identification code. | PmtRtr/TxInf/OrgnITxRef/Dbtr/Pty/Id | No | Only schema validation is performed. |
| AT-D001 | Debtor Account | The IBAN of the account of the Originator. | PmtRtr/TxInf/OrgnITxRef/DbtrAcct/Id/IBAN | Yes | Only schema validation is performed. |
| AT-P003 | Proxy | Specifies an alternate assumed name for the identification of the account. | PmtRtr/TxInf/OrgnITxRef/DbtrAcct/Prxy | No | Only schema validation is performed. |
| AT-D002 | Debtor Agent | The BIC code of the Originator PSP. | PmtRtr/TxInf/OrgnITxRef/DbtrAgt | No | This field is used in TIPS for recall response processing. |
| AT-C002 | Creditor Agent | The BIC code of the Beneficiary PSP. | PmtRtr/TxInf/OrgnITxRef/CdtrAgt | No | This field is used in TIPS for recall response processing. |
| AT-E001 | Creditor + Name | The name of the Beneficiary. | PmtRtr/TxInf/OrgnITxRef/Cdtr/Pty/Nm | No | Only schema validation is performed. |
| AT-E004 | Creditor + Postal Address | The address of the Beneficiary. | PmtRtr/TxInf/OrgnITxRef/Cdtr/Pty/PstlAdr | No | Only schema validation is performed. |
| AT-E005 | Creditor + Identification | The Beneficiary identification code. | PmtRtr/TxInf/OrgnITxRef/Cdtr/Pty/Id | No | Only schema validation is performed. |
| AT-C001 | Creditor Account | The IBAN of the account of the Beneficiary. | PmtRtr/TxInf/OrgnITxRef/CdtrAcct | Yes | Only schema validation is performed. |
| AT-E003 | Proxy | Specifies an alternate assumed name for the identification of the account. | PmtRtr/TxInf/OrgnITxRef/CdtrAcct/Prxy | No | Only schema validation is performed. |

| EPC Ref. | Reference Name | EPC/ISO Description | XML path | Mand. | TIPS Usage |
|----------|------------------------------------|---|--|-------|--------------------------------------|
| AT-E007 | Ultimate Creditor + Name | Name of the Beneficiary Reference Party. | PmtRtr/TxInf/OrgnTxRef/UltmtCdr/Pty/Nm | No | Only schema validation is performed. |
| AT-E010 | Ultimate Creditor + Identification | Identification code of the Beneficiary Reference Party. | PmtRtr/TxInf/OrgnTxRef/UltmtCdr/Pty/Id | No | Only schema validation is performed. |
| AT-T007 | Purpose | Underlying reason for the payment transaction. | PmtRtr/TxInf/OrgnTxRef/Purp | No | Only schema validation is performed. |

3.3.2.1.3 FIToFICustomerCreditTransfer (pacs.008.001.08)

The FIToFICustomerCreditTransfer message allows instructing TIPS for an Instant Payment transaction of a positive amount of money from the originator participant account to the beneficiary participant account.

Message specification is compliant to EPC DS-02 Inter-PSP Payment Dataset as described in the SEPA Instant Credit Transfer scheme Rulebook.

References/links

The schema and the related documentation in XSD/EXCEL/PDF format as well as the message examples are provided within the MyStandards repository under the following link:

<https://www.swift.com/mystandards/TIPS/pacs.008.001.08>

Table 80 – Description of the fields for DS-02 Dataset vs pacs.008.001.08

| EPC Ref. | Reference Name | EPC/ISO Description | XML path | Mand. | TIPS Usage |
|----------|-----------------------------------|---|--|-------|---|
| n/a | Message Identification | Point to point reference, as assigned by the instructing party. | FIToFICstmrCdtTrf/GrpHdr/MsgId | Yes | Only schema validation is performed. |
| n/a | Creation Date Time | Date and time at which the message was created. | FIToFICstmrCdtTrf/GrpHdr/CreDtTm | Yes | Only schema validation is performed. |
| n/a | Number Of Transactions | Number of individual transactions contained in the message. | FIToFICstmrCdtTrf/GrpHdr/NbOfTx | Yes | Possible values are checked within schema validation. |
| n/a | Total Interbank Settlement Amount | Total amount of money moved between the instructing agent and the instructed agent. | FIToFICstmrCdtTrf/GrpHdr/TtlIntrBkSttlmAmt | Yes | Only schema validation is performed. |
| AT-T051 | Settlement Date | The Settlement Date of the SCT ^{Inst} Transaction | FIToFICstmrCdtTrf/GrpHdr/intrBkSttlmDt | Yes | Only schema validation is performed. |
| n/a | Settlement Information | Specifies the details on how the settlement of the transaction between the instructing agent and the instructed agent is completed. | FIToFICstmrCdtTrf/GrpHdr/SttlmInf | Yes | Only schema validation is performed. |
| n/a | Settlement Method | Method used to settle the Instant Payment Transaction. | FIToFICstmrCdtTrf/GrpHdr/SttlmInf/SttlmMtd | Yes | Possible values are checked within schema validation. |

| EPC Ref. | Reference Name | EPC/ISO Description | XML path | Mand. | TIPS Usage |
|----------|---|---|---|-------|--|
| n/a | Settlement Account | A specific purpose account used to post debit and credit entries as a result of the transaction. | FIToFICstmrCdtTrf/GrpHdr/SttlmInf/SttlmAcct | No | Only schema validation is performed. |
| n/a | Clearing System | Specification of a pre-agreed offering between clearing agents or the channel through which the Instant Payment transaction is processed. | FIToFICstmrCdtTrf/GrpHdr/SttlmInf/ClrSys | No | Only schema validation is performed. |
| n/a | Payment Type Information | Set of elements used to further specify the type of transaction. | FIToFICstmrCdtTrf/GrpHdr/PmtTpInf | Yes | Only schema validation is performed. |
| AT-T001 | Scheme Identification Code | The identification code of the SCT ^{Inst} Scheme | FIToFICstmrCdtTrf/GrpHdr/PmtTpInf/SvcLvl/Cd FIToFICstmrCdtTrf/GrpHdr/PmtTpInf/LclInstrm/Cd | Yes | Possible values are checked within schema validation. |
| AT-T008 | Category Purpose | The category purpose of the SCT ^{Inst} Instruction | FIToFICstmrCdtTrf/GrpHdr/PmtTpInf/CtgyPurp | No | Only schema validation is performed. |
| n/a | Instructing Agent | Agent that instructs the next party in the chain to carry out the instruction. | FIToFICstmrCdtTrf/GrpHdr/instgAgt | No | Only schema validation is performed. |
| n/a | Instructed Agent | Agent that is instructed by the previous party in the chain to carry out the instruction. | FIToFICstmrCdtTrf/GrpHdr/instdAgt | No | Only schema validation is performed. |
| n/a | Credit Transfer Transaction Information | Set of elements providing information specific to the individual credit transfer. | FIToFICstmrCdtTrf/CdtTrfTxInf | Yes | Only schema validation is performed. |
| n/a | Instruction Identification | Unique identification, as assigned by an instructing party for an instructed party. | FIToFICstmrCdtTrf/CdtTrfTxInf/PmtId/InstrId | No | Only schema validation is performed. |
| AT-T014 | End To End Identification | The Originator's reference of the SCT ^{Inst} Transaction | FIToFICstmrCdtTrf/CdtTrfTxInf/PmtId/EndToEndId | Yes | Only schema validation is performed. In the event that no reference was given, NOTPROVIDED must be used. |
| AT-T054 | Transaction Identification | The Originator PSP's reference number of the SCT ^{Inst} Transaction message | FIToFICstmrCdtTrf/CdtTrfTxInf/PmtId/TxId | Yes | The Transaction Reference used to identify the Instant Payment transaction and perform the duplicate check |
| AT-T002 | Settlement Amount | The amount of SCT ^{Inst} in euro | FIToFICstmrCdtTrf/CdtTrfTxInf/IntrBkSttlmAmt | Yes | The currency of the Settlement Amount must be the same of the Creditor and Debtor Accounts |
| AT-T056 | Acceptance Timestamp | Timestamp of the SCT ^{Inst} Transaction | FIToFICstmrCdtTrf/CdtTrfTxInf/AcceptncDtTm | Yes | The Acceptance Timestamp is used as a starting point in time for the Instant Payment transaction processing at Originator PSP level. The Acceptance Timestamp shall be expressed in UTC. The Timestamp must be unambiguous and at least include seconds. |

| EPC Ref. | Reference Name | EPC/ISO Description | XML path | Mand. | TIPS Usage |
|----------|---|--|--|-------|--|
| n/a | Charge Bearer | Specifies which party/parties will bear the charges associated with the processing of the payment transaction. | FIToFICstmrCdtTrf/CdtTrfTxInf/ChrgBr | Yes | Only schema validation is performed. |
| AT-P006 | Originator Reference Party Name | The name of the Originator Reference Party | FIToFICstmrCdtTrf/CdtTrfTxInf/UltmtDbtr/Nm | No | Only schema validation is performed. |
| AT-P007 | Originator Reference Party Identification Code | The identification code of the Originator Reference Party | FIToFICstmrCdtTrf/CdtTrfTxInf/UltmtDbtr/Id | No | Only schema validation is performed. |
| n/a | Ultimate Debtor + Identification ++ Organisation Identification | Unique and unambiguous way to identify an organisation. | FIToFICstmrCdtTrf/CdtTrfTxInf/UltmtDbtr/Id/OrgId | Yes | Either 'AnyBIC', 'LEI' or one occurrence of 'Other' is allowed. |
| n/a | Ultimate Debtor + Identification ++ Private Identification | Unique and unambiguous identification of a person, eg, passport. | FIToFICstmrCdtTrf/CdtTrfTxInf/UltmtDbtr/Id/PrvtId | Yes | Either 'Date and Place of Birth' or one occurrence of 'Other' is allowed. |
| n/a | Debtor | Party that owes an amount of money to the (ultimate) creditor. | FIToFICstmrCdtTrf/CdtTrfTxInf/Dbtr | Yes | Only schema validation is performed. |
| AT-P001 | Originator Name | The name of the Originator | FIToFICstmrCdtTrf/CdtTrfTxInf/Dbtr/Nm | Yes | Only schema validation is performed. |
| AT-P005 | Originator Address | The address of the Originator | FIToFICstmrCdtTrf/CdtTrfTxInf/Dbtr/PstlAdr | No | If 'Address Line' is used, then 'Postal Address' sub-elements other than 'Country' are forbidden. A combination of 'Address Line' and 'Country' is allowed; it is recommended when either the Debtor Agent or Creditor Agent is a non-EEA SEPA PSP. If 'Address Line' is not used, then at least 'Town Name' and 'Country' must be used. |
| n/a | Debtor + Postal Address ++ Department | Identification of a division of a large organisation or building | FIToFICstmrCdtTrf/CdtTrfTxInf/Dbtr/PstlAdr/Dept | No | Only schema validation is performed. |
| n/a | Debtor + Postal Address ++ Sub Department | Identification of a sub-division of a large organisation or building | FIToFICstmrCdtTrf/CdtTrfTxInf/Dbtr/PstlAdr/SubDept | No | Only schema validation is performed. |
| n/a | Debtor + Postal Address ++ Street Name | Name of a street or thoroughfare | FIToFICstmrCdtTrf/CdtTrfTxInf/Dbtr/PstlAdr/StrtNm | No | Only schema validation is performed. |
| n/a | Debtor + Postal Address ++ Building Number | Number that identifies the position of a building on a street | FIToFICstmrCdtTrf/CdtTrfTxInf/Dbtr/PstlAdr/BldgNb | No | Only schema validation is performed. |
| n/a | Debtor + Postal Address ++ Building Name | Name of the building or house | FIToFICstmrCdtTrf/CdtTrfTxInf/Dbtr/PstlAdr/BldgNm | No | Only schema validation is performed. |
| n/a | Debtor + Postal Address ++ Floor | Floor or storey within a building | FIToFICstmrCdtTrf/CdtTrfTxInf/Dbtr/PstlAdr/Flr | No | Only schema validation is performed. |
| n/a | Debtor + Postal Address ++ Post Box | Numbered box in a post office, assigned to a person or organisation, where letters are kept until called for | FIToFICstmrCdtTrf/CdtTrfTxInf/Dbtr/PstlAdr/PstBx | No | Only schema validation is performed. |

| EPC Ref. | Reference Name | EPC/ISO Description | XML path | Mand. | TIPS Usage |
|----------|--|--|--|-------|---|
| n/a | Debtor + Postal Address ++ Room | Building room number | FItoFICstmrCdtTrf/CdtTrf TxInf/Dbtr/PstlAdr/Room | No | Only schema validation is performed. |
| n/a | Debtor + Postal Address ++ Post Code | Identifier consisting of a group of letters and/or numbers that is added to a postal address to assist the sorting of mail | FItoFICstmrCdtTrf/CdtTrf TxInf/Dbtr/PstlAdr/PstCd | No | Only schema validation is performed. |
| n/a | Debtor + Postal Address ++ Town Name | Name of a built-up area, with defined boundaries, and a local government | FItoFICstmrCdtTrf/CdtTrf TxInf/Dbtr/PstlAdr/TwnNm | No | Only schema validation is performed. |
| n/a | Debtor + Postal Address ++ Town Location Name | Specific location name within the town | FItoFICstmrCdtTrf/CdtTrf TxInf/Dbtr/PstlAdr/TwnLctnNm | No | Only schema validation is performed. |
| n/a | Debtor + Postal Address ++ District Name | Identifies a subdivision within a country subdivision | FItoFICstmrCdtTrf/CdtTrf TxInf/Dbtr/PstlAdr/DstrctNm | No | Only schema validation is performed. |
| n/a | Debtor + Postal Address ++ Country Sub Division | Identifies a subdivision of a country such as state, region, county | FItoFICstmrCdtTrf/CdtTrf TxInf/Dbtr/PstlAdr/CtrySubDvsn | No | Only schema validation is performed. |
| n/a | Debtor + Postal Address ++ Country Code | Nation with its own government. | FItoFICstmrCdtTrf/CdtTrf TxInf/Dbtr/PstlAdr/Ctry | No | Only schema validation is performed. |
| n/a | Debtor + Postal Address ++ Address Line | Information that locates and identifies a specific address, as defined by postal services, presented in free format text. | FItoFICstmrCdtTrf/CdtTrf TxInf/Dbtr/PstlAdr/AdrLine | No | If 'Address Line' is used, then 'Postal Address' sub-elements other than 'Country' are forbidden. A combination of 'Address Line' and 'Country' is allowed; it is recommended when either Debtor Agent or Creditor Agent is a non-EEA SEPA PSP. |
| AT-P004 | Originator Identification Code | The Originator identification code | FItoFICstmrCdtTrf/CdtTrf TxInf/Dbtr/Id | No | Only schema validation is performed. |
| n/a | Debtor + Identification ++ Organisation Identification | Unique and unambiguous way to identify an organisation | FItoFICstmrCdtTrf/CdtTrf TxInf/Dbtr/Id/OrgId | Yes | Either 'AnyBIC', 'LEI' or one occurrence of 'Other' is allowed. |
| n/a | Debtor + Identification ++ Private Identification | Unique and unambiguous identification of a person, eg, passport. | FItoFICstmrCdtTrf/CdtTrf TxInf/Dbtr/Id/PrvtId | Yes | Either 'Date and Place of Birth' or one occurrence of 'Other' is allowed. |
| AT-D001 | Originator IBAN | The IBAN of the account of the Originator | FItoFICstmrCdtTrf/CdtTrf TxInf/DbtrAcct/Id/IBAN | Yes | Only schema validation is performed. |
| AT-P003 | Proxy | Specifies an alternate assumed name for the identification of the account | FItoFICstmrCdtTrf/CdtTrf TxInf/DbtrAcct/Prxy | No | Only schema validation is performed. |
| AT-D002 | Originator BIC | The BIC code of the Originator PSP | FItoFICstmrCdtTrf/CdtTrf TxInf/DbtrAgt/FinInstnId/BICFI | Yes | The Distinguished Name of the sender must be authorised to instruct for the Originator BIC. The Originator BIC must be stored as an Account Authorised BIC or CMB user |

| EPC Ref. | Reference Name | EPC/ISO Description | XML path | Mand. | TIPS Usage |
|----------|---|--|--|-------|--|
| AT-C002 | Beneficiary BIC | The BIC code of the Beneficiary PSP | FIToFICstmrCdtTrf/CdtTrfTxInf/CdtrAgt/FinInstnId/BICFI | Yes | The Beneficiary BIC must be linked with at least one Distinguished Name for outbound message routing |
| n/a | Creditor | Party to which an amount of money is due. | FIToFICstmrCdtTrf/CdtTrfTxInf/Cdtr | Yes | Only schema validation is performed. |
| AT-E001 | Creditor Name | The name of the Beneficiary | FIToFICstmrCdtTrf/CdtTrfTxInf/Cdtr/Nm | Yes | Only schema validation is performed. |
| AT-E004 | Creditor Address | The address of the Beneficiary | FIToFICstmrCdtTrf/CdtTrfTxInf/Cdtr/PstlAdr | No | If 'Address Line' is used, then 'Postal Address' sub-elements other than 'Country' are forbidden. A combination of 'Address Line' and 'Country' is allowed. If 'Address Line' is not used, then at least 'Town Name' and 'Country' must be used. |
| n/a | Creditor + Postal Address ++ Department | Identification of a division of a large organisation or building | FIToFICstmrCdtTrf/CdtTrfTxInf/Cdtr/PstlAdr/Dept | No | Only schema validation is performed. |
| n/a | Creditor + Postal Address ++ Sub Department | Identification of a sub-division of a large organisation or building | FIToFICstmrCdtTrf/CdtTrfTxInf/Cdtr/PstlAdr/SubDept | No | Only schema validation is performed. |
| n/a | Creditor + Postal Address ++ Street Name | Name of a street or thoroughfare | FIToFICstmrCdtTrf/CdtTrfTxInf/Cdtr/PstlAdr/StrtNm | No | Only schema validation is performed. |
| n/a | Creditor + Postal Address ++ Building Number | Number that identifies the position of a building on a street | FIToFICstmrCdtTrf/CdtTrfTxInf/Cdtr/PstlAdr/BldgNb | No | Only schema validation is performed. |
| n/a | Creditor + Postal Address ++ Building Name | Name of the building or house | FIToFICstmrCdtTrf/CdtTrfTxInf/Cdtr/PstlAdr/BldgNm | No | Only schema validation is performed. |
| n/a | Creditor + Postal Address ++ Floor | Floor or storey within a building | FIToFICstmrCdtTrf/CdtTrfTxInf/Cdtr/PstlAdr/Flr | No | Only schema validation is performed. |
| n/a | Creditor + Postal Address ++ Post Box | Numbered box in a post office, assigned to a person or organisation, where letters are kept until called for | FIToFICstmrCdtTrf/CdtTrfTxInf/Cdtr/PstlAdr/PstBx | No | Only schema validation is performed. |
| n/a | Creditor + Postal Address ++ Room | Building room number | FIToFICstmrCdtTrf/CdtTrfTxInf/Cdtr/PstlAdr/Room | No | Only schema validation is performed. |
| n/a | Creditor + Postal Address ++ Post Code | Identifier consisting of a group of letters and/or numbers that is added to a postal address to assist the sorting of mail | FIToFICstmrCdtTrf/CdtTrfTxInf/Cdtr/PstlAdr/PstCd | No | Only schema validation is performed. |
| n/a | Creditor + Postal Address ++ Town Name | Name of a built-up area, with defined boundaries, and a local government | FIToFICstmrCdtTrf/CdtTrfTxInf/Cdtr/PstlAdr/TwnNm | No | Only schema validation is performed. |
| n/a | Creditor + Postal Address ++ Town Location Name | Specific location name within the town | FIToFICstmrCdtTrf/CdtTrfTxInf/Cdtr/PstlAdr/TwnLctnNm | No | Only schema validation is performed. |
| n/a | Creditor + Postal Address ++ District Name | Identifies a subdivision within a country sub-division | FIToFICstmrCdtTrf/CdtTrfTxInf/Cdtr/PstlAdr/DstrctNm | No | Only schema validation is performed. |

| EPC Ref. | Reference Name | EPC/ISO Description | XML path | Mand. | TIPS Usage |
|----------|--|---|--|-------|---|
| n/a | Creditor + Postal Address ++ Country Sub Division | Identifies a subdivision of a country such as state, region, county | FItoFICstmrCdtTrf/CdtTrfTxInf/Cdtr/PstlAdr/CtrySubDvsn | No | Only schema validation is performed. |
| n/a | Creditor + Postal Address ++ Country Code | Nation with its own government. | FItoFICstmrCdtTrf/CdtTrfTxInf/Cdtr/PstlAdr/Ctry | No | Only schema validation is performed. |
| n/a | Creditor + Postal Address ++ Address Line | Information that locates and identifies a specific address, as defined by postal services, presented in free format text. | FItoFICstmrCdtTrf/CdtTrfTxInf/Cdtr/PstlAdr/AdrLine | No | If 'Address Line' is used, then 'Postal Address' sub-elements other than 'Country' are forbidden. A combination of 'Address Line' and 'Country' is allowed. |
| AT-E005 | Creditor Identification | The Beneficiary identification code | FItoFICstmrCdtTrf/CdtTrfTxInf/Cdtr/Id | No | Only schema validation is performed. |
| n/a | Creditor + Identification ++ Organisation Identification | Unique and unambiguous way to identify an organisation | FItoFICstmrCdtTrf/CdtTrfTxInf/Cdtr/Id/OrgId | Yes | Either 'AnyBIC', 'LEI' or one occurrence of 'Other' is allowed. |
| n/a | Creditor + Identification ++ Private Identification | Unique and unambiguous identification of a person, eg, passport. | FItoFICstmrCdtTrf/CdtTrfTxInf/Cdtr/Id/PrvtId | Yes | Either 'Date and Place of Birth' or one occurrence of 'Other' is allowed. |
| AT-C001 | Creditor Account | The IBAN of the account of the beneficiary | FItoFICstmrCdtTrf/CdtTrfTxInf/CdtrAcct/Id/IBAN | Yes | Only schema validation is performed. |
| AT-E003 | Proxy | Specifies an alternate assumed name for the identification of the account | FItoFICstmrCdtTrf/CdtTrfTxInf/CdtrAcct/Prxy | No | Only schema validation is performed. |
| n/a | Ultimate Creditor | Ultimate party to which an amount of money is due. | FItoFICstmrCdtTrf/CdtTrfTxInf/UltmtCdtr | No | Only schema validation is performed. |
| AT-E007 | Ultimate Creditor Name | The name of the Beneficiary Reference Party | FItoFICstmrCdtTrf/CdtTrfTxInf/UltmtCdtr/Nm | No | Only schema validation is performed. |
| AT-E010 | Ultimate Creditor Identification | The identification code of the Beneficiary Reference Party | FItoFICstmrCdtTrf/CdtTrfTxInf/UltmtCdtr/Id | No | Only schema validation is performed. |
| n/a | Ultimate Creditor + Identification ++ Organisation Identification | Information that locates and identifies a specific address, as defined by postal services, presented in free format text. | FItoFICstmrCdtTrf/CdtTrfTxInf/UltmtCdtr/Id/OrgId | Yes | Either 'AnyBIC', 'LEI' or one occurrence of 'Other' is allowed. |
| n/a | Ultimate Creditor + Identification ++ Private Identification | Unique and unambiguous identification of a person, eg, passport. | FItoFICstmrCdtTrf/CdtTrfTxInf/UltmtCdtr/Id/PrvtId | Yes | Either 'Date and Place of Birth' or one occurrence of 'Other' is allowed. |
| AT-T007 | Purpose | The purpose of the SCT ^{Inst} Instruction | FItoFICstmrCdtTrf/CdtTrfTxInf/Purp | No | Only schema validation is performed. |
| AT-T009 | Remittance Information | The Remittance Information | FItoFICstmrCdtTrf/CdtTrfTxInf/RmtInf | No | Only schema validation is performed. |

| EPC Ref. | Reference Name | EPC/ISO Description | XML path | Mand. | TIPS Usage |
|----------|---|---|--|-------|--|
| n/a | Remittance Information + Unstructured | Information supplied to enable the matching/reconciliation of an entry with the items that the payment is intended to settle, such as commercial invoices in an account receivable system, in an unstructured form. | FIToFICstmrCdtTrf/CdtTrfTxInf/RmtInf/Ustrd | No | Either Unstructured or Structured may be present. If both components are included, the message will be rejected during the schema validation process. |
| n/a | Remittance Information + Structured | Information supplied to enable the matching/reconciliation of an entry with the items that the payment is intended to settle, such as commercial invoices in an account receivable system, in a structured form. | FIToFICstmrCdtTrf/CdtTrfTxInf/RmtInf/Strd | No | Either Unstructured or Structured may be present. If both components are included, the message will be rejected during the schema validation process. |
| n/a | Remittance Information + Structured ++ Creditor Reference Information | Information supplied to enable the matching/reconciliation of an entry with the items that the payment is intended to settle, such as commercial invoices in an account receivable system, in a structured form. | FIToFICstmrCdtTrf/CdtTrfTxInf/RmtInf/Strd/CdtrRefInf | No | As the Creditor PSP is not obliged to validate the reference information, TIPS will apply schema validation to this component and included sub-components. |

3.3.2.1.4 FIToFIPaymentStatusRequest (pacs.028.001.03)

The FI to FI Payment Status Request message allows instructing TIPS for retrieving the status of a single or group of Instant Payment transactions.

This message covers the scenario of (i) Status investigation message and (ii) Request for Status Update on a Recall:

- The Originator PSP, Ancillary System or Instructing Party can start the investigation process on a single or group of previously instructed Instant Payment Transactions;
- The Originator PSP, Ancillary System or Instructing Party can start the Request for Status Update on a single or group of Recalls previously instructed.

Message specification is compliant to EPC DS-07 Inter-PSP Payment Dataset as described in the SEPA Instant Credit Transfer scheme Rulebook.

Additional optional and mandatory fields not included in the DS-07 definition or in the following table, but foreseen by the EPC SCT Inst Inter-PSP Implementation Guidelines, are not used in TIPS.

References/links

The schema and the related documentation in XSD/EXCEL/PDF format as well as the message examples are provided within the MyStandards repository under the following link:

<https://www.swift.com/mystandards/TIPS/pacs.028.001.03>

Table 81 – Status investigation Message EPC DS-07 vs pacs.028.001.03

| EPC Ref. | Reference Name | EPC/ISO Description | XML path | Mand. | TIPS Usage |
|----------|--------------------------------------|--|---|-------|---|
| n/a | Message Identification | Point to point reference, as assigned by the instructing party. | FIToFIPmtStsReq/GrpHdr/MsgId | Yes | Only schema validation is performed. |
| n/a | Creation Date Time | Date and time at which the message was created. | FIToFIPmtStsReq/GrpHdr/CreDtTm | Yes | Only schema validation is performed. |
| n/a | Instructing Agent | Agent that instructs the next party in the chain to carry out the instruction. | FIToFIPmtStsReq/GrpHdr/InstgAgt | No | Only schema validation is performed. |
| n/a | Instructed Agent | Agent that is instructed by the previous party in the chain to carry out the instruction. | FIToFIPmtStsReq/GrpHdr/InstdAgt | No | Only schema validation is performed. |
| n/a | Original Message Identification | Message Identification of the originating message | FIToFIPmtStsReq/OrgnlGrpInf/OrgnlMsgId | Yes | Only schema validation is performed. |
| n/a | Original Message Name Identification | Message identifier of the originating message | FIToFIPmtStsReq/OrgnlGrpInf/OrgnlMsgNmId | Yes | Possible allowed values ⁵⁸ : "pacs.008.001.08" or "pacs.008.001.02" |
| n/a | Status Request Identification | Unique identification, as assigned by an instructing party for an instructed party. | FIToFIPmtStsReq/TxInf/stsReqId | Yes | Only schema validation is performed. |
| n/a | Original Instruction Identification | Unique identification, as assigned by the original instructing party for the original instructed party | FIToFIPmtStsReq/TxInf/OrgnlInstrId | No | Only schema validation is performed. |
| AT-T014 | Original End To End Identification | The Originator's reference of the SCT ^{Inst} Transaction | FIToFIPmtStsReq/TxInf/OrgnlEndToEndId | Yes | Only schema validation is performed. |
| AT-T054 | Transaction Identification | The Originator PSP's reference number of the SCT ^{Inst} Transaction message | FIToFIPmtStsReq/TxInf/OrgnlTxId | Yes | Identification of the Payment Transaction to be investigated. |
| AT-T056 | Acceptance Timestamp | Timestamp of the SCT ^{Inst} Transaction | FIToFIPmtStsReq/TxInf/acptncDtTm | No | Acceptance timestamp of the Payment Transaction to be investigated. In case it is not filled, the investigation on the related transaction will be rejected by TIPS. |
| AT-T008 | Category Purpose | The category purpose of the SCT ^{Inst} Instruction | FIToFIPmtStsReq/TxInf/OrgnlTxRef/PmtTplnf/CtgyPurp | No | Only schema validation is performed. |
| AT-001 | Scheme Identification Code | The identification code of the SCT ^{Inst} Scheme | FIToFIPmtStsReq/TxInf/OrgnlTxRef/PmtTplnf/SvcLvl/Cd FIToFIPmtStsReq/TxInf/OrgnlTxRef/PmtTplnf/LclInstrm/Cd | Yes | Possible values are checked within schema validation. |
| AT-D002 | Originator BIC | The BIC code of the Originator PSP | FIToFIPmtStsReq/TxInf/OrgnlTxRef/DbtrAgt/FinlnstnId/BICFI | Yes | This field is used in combination with the requestor Distinguished Name |

⁵⁸ The usage of the correct Original Message Name Identification, in relation to the moment in which the original message was sent in reference to the migration date to the 2019 message version of ISO 20022, should be ensured by the actor who generates and sends the message to TIPS: no check on the correspondence of this value with respect to the version of the original message is performed by TIPS.

| EPC Ref. | Reference Name | EPC/ISO Description | XML path | Mand. | TIPS Usage |
|----------|----------------|---------------------|----------|-------|------------------------------|
| | | | | | to check user access rights. |

Table 82 – Request for Status Update on a Recall

| EPC Ref. | Reference Name | EPC/ISO Description | XML path | Mand. | TIPS Usage |
|----------|--------------------------------------|---|---|-------|--|
| n/a | Message Identification | Point to point reference, as assigned by the instructing party. | FIToFIPmtStsReq/GrpHdr/MsgId | Yes | Only schema validation is performed. |
| n/a | Creation Date Time | Date and time at which the message was created. | FIToFIPmtStsReq/GrpHdr/CreDtTm | Yes | Only schema validation is performed. |
| n/a | Instructing Agent | Agent that instructs the next party in the chain to carry out the instruction. | FIToFIPmtStsReq/GrpHdr/InstgAgt | No | Only schema validation is performed. |
| n/a | Instructed Agent | Agent that is instructed by the previous party in the chain to carry out the instruction. | FIToFIPmtStsReq/GrpHdr/InstdAgt | No | Only schema validation is performed. |
| n/a | Original Message Identification | Message Identification of the originating message | FIToFIPmtStsReq/OrgnlGrpInf/OrgnlMsgId | Yes | Only schema validation is performed. |
| n/a | Original Message Name Identification | Message identifier of the originating message | FIToFIPmtStsReq/OrgnlGrpInf/OrgnlMsgNmId | Yes | Possible allowed values ⁵⁹ : “camt.056.001.08” or “camt.056.001.01” |
| n/a | Status Request Identification | Unique identification, as assigned by an instructing party for an instructed party. | FIToFIPmtStsReq/TxInf/stsReqId | Yes | Only schema validation is performed. |
| n/a | Original Instruction Identification | Cancellation ID of the relevant camt.056 Transaction Information. | FIToFIPmtStsReq/TxInf/OrgnlInstrId | No | If not present, the message will be rejected during the schema validation process. |
| AT-T14 | Original End To End Identification | The Originator's reference of the SCT ^{Inst} Transaction | FIToFIPmtStsReq/TxInf/OrgnlEndToEndId | Yes | Only schema validation is performed. |
| AT-T054 | Transaction Identification | The Originator PSP's reference number of the SCT ^{Inst} Transaction message | FIToFIPmtStsReq/TxInf/OrgnlTxId | Yes | Identification of the Payment Transaction to be investigated. |
| AT-T056 | Acceptance Timestamp | Timestamp of the SCT ^{Inst} Transaction | FIToFIPmtStsReq/TxInf/accptncDtTm | No | Acceptance timestamp of the Payment Transaction to be investigated. |
| n/a | Original Transaction Reference | Same values as the message elements of the original instruction. | FIToFIPmtStsReq/TxInf/OrgnlTxRef | Yes | Only schema validation is performed. |
| AT-T002 | Settlement Amount | Amount of the SCT ^{Inst} in euro. | FIToFIPmtStsReq/TxInf/OrgnlTxRef/IntrBkSttlmAmt | No | Only schema validation is performed. |
| AT-T051 | Settlement Date | The Settlement Date of the SCT ^{Inst} Transaction. | FIToFIPmtStsReq/TxInf/OrgnlTxRef/IntrBkSttlmDt | No | Only schema validation is performed. |
| n/a | Settlement Information | Specifies the details on the settlement. | FIToFIPmtStsReq/TxInf/OrgnlTxRef/SttlmInf | No | Only schema validation is performed. |

⁵⁹ The usage of the correct Original Message Name Identification, in relation to the moment in which the original message was sent in reference to the migration date to the 2019 message version of ISO 20022, should be ensured by the actor who generates and sends the message to TIPS: no check on the correspondence of this value with respect to the version of the original message is performed by TIPS.

| EPC Ref. | Reference Name | EPC/ISO Description | XML path | Mand. | TIPS Usage |
|----------|--|---|---|-------|--|
| AT-001 | Scheme Identification Code | The identification code of the SCT ^{inst} scheme | FItoFIPmtStsReq/TxInf/OrgnlTxRef/PmtTpInf/SvcLvl/Cd FItoFIPmtStsReq/TxInf/OrgnlTxRef/PmtTpInf/Lcllnstrm/Cd | Yes | Possible values are checked within schema validation. |
| AT-T008 | Category Purpose | The category purpose of the SCT ^{inst} Instruction | FItoFIPmtStsReq/TxInf/OrgnlTxRef/PmtTpInf/CtgyPurp | No | Only schema validation is performed. |
| AT-T009 | Remittance Information | The Remittance information. | FItoFIPmtStsReq/TxInf/OrgnlTxRef/Rmtlnf | No | Only schema validation is performed. |
| AT-P006 | Originator Reference Party Name | The name of the Originator Reference Party | FItoFIPmtStsReq/TxInf/OrgnlTxRef/UltmtDbtr/Pty/Nm | No | Only schema validation is performed. |
| AT-P007 | Originator Reference Party Identification Code | The identification code of the Originator Reference Party | FItoFIPmtStsReq/TxInf/OrgnlTxRef/UltmtDbtr/Pty/Id | No | Only schema validation is performed. |
| AT-P001 | Debtor + Name | The name of the Originator. | FItoFIPmtStsReq/TxInf/OrgnlTxRef/Dbtr/Pty/Nm | No | Only schema validation is performed. |
| AT-P005 | Debtor + Postal Address | The address of the Originator. | FItoFIPmtStsReq/TxInf/OrgnlTxRef/Dbtr/Pty/PstlAdr | No | Only schema validation is performed. |
| AT-P004 | Debtor + Identification | The Originator identification code. | FItoFIPmtStsReq/TxInf/OrgnlTxRef/Dbtr/Pty/Id | No | Only schema validation is performed. |
| AT-D001 | Debtor Account | The IBAN of the account of the Originator. | FItoFIPmtStsReq/TxInf/OrgnlTxRef/DbtrAcct/Id | No | Only schema validation is performed. |
| AT-P003 | Proxy | The Proxy/Alias of the account of the Originator | FItoFIPmtStsReq/TxInf/OrgnlTxRef/DbtrAcct/Proxy | No | Only schema validation is performed. |
| AT-D002 | Debtor Agent | The BIC code of the Originator PSP | FItoFIPmtStsReq/TxInf/OrgnlTxRef/DbtrAgt/FinInstnId/BICFI | Yes | This field is used in combination with the requestor Distinguished Name to check user access rights. |
| AT-C002 | Creditor Agent | The BIC code of the Beneficiary PSP. | FItoFIPmtStsReq/TxInf/OrgnlTxRef/CdtrAgt/FinInstnId/BICFI | No | This field is used to forward the request. If not present, the message will be rejected. Multiple instances of Transaction Information must report the same Creditor Agent BIC. Otherwise the message will be rejected by TIPS |
| AT-E001 | Creditor + Name | The name of the Beneficiary. | FItoFIPmtStsReq/TxInf/OrgnlTxRef/Cdtr/Pty/Nm | No | Only schema validation is performed. |
| AT-E004 | Creditor + Postal Address | The address of the Beneficiary. | FItoFIPmtStsReq/TxInf/OrgnlTxRef/Cdtr/PstlAdr | No | Only schema validation is performed. |
| AT-E005 | Creditor + Identification | The Beneficiary identification code. | FItoFIPmtStsReq/TxInf/OrgnlTxRef/Cdtr/Id | No | Only schema validation is performed. |
| AT-C001 | Creditor Account | The IBAN of the account of the Beneficiary. | FItoFIPmtStsReq/TxInf/OrgnlTxRef/CdtrAcct | No | Only schema validation is performed. |

| EPC Ref. | Reference Name | EPC/ISO Description | XML path | Mand. | TIPS Usage |
|----------|------------------------------------|---|---|-------|--------------------------------------|
| AT-E003 | Proxy | The Proxy/Alias of the account of the Beneficiary | FItoFIPmtStsReq/TxInf/OrgnlTxRef/CdtrAcct/Proxy | No | Only schema validation is performed. |
| AT-E007 | Ultimate Creditor + Name | Name of the Beneficiary Reference Party. | FItoFIPmtStsReq/TxInf/OrgnlTxRef/UltmtCdtr/Nm | No | Only schema validation is performed. |
| AT-E010 | Ultimate Creditor + Identification | Identification code of the Beneficiary Reference Party. | FItoFIPmtStsReq/TxInf/OrgnlTxRef/UltmtCdtr/Id | No | Only schema validation is performed. |
| AT-T007 | Purpose | Underlying reason for the payment transaction. | FItoFIPmtStsReq/TxInf/OrgnlTxRef/Purp | No | Only schema validation is performed. |

3.3.2.1.5 FItoFIPaymentStatusReport (pacs.002.001.10)

The FItoFIPaymentStatusReport message is used in several business cases for non-Euro settlement models:

1. It is sent by TIPS to the Originator Participant to report a rejection for a pacs.008 transaction;
2. It is sent by the Beneficiary Participant or Instructing Party to TIPS to report the processing result of a pacs.008 sent by TIPS upon request of an Originator Participant;
3. The message as received by the Beneficiary Participant is forwarded to the Originator Participant. This scenario covers also the positive response to a Status Investigation request;
4. It is sent by TIPS to the Beneficiary Participant as a confirmation for processing of the pacs.002 received from the Beneficiary Participant itself;
5. It is sent by TIPS to the Originator Participant after a negative response to a Status Investigation request;
6. It is sent by TIPS to the Originator Participant (e.g., in case of errors during the conditional phase or in case of timeout condition triggered by TIPS) during either the conditional phase or settlement phase);
7. It is sent by TIPS to the sender of the Recall in case of errors;
8. It is sent by TIPS to the sender of the positive Recall Answer either as a positive settlement confirmation or in case of errors (e.g. not sufficient funds to settle the positive recall or validation error related to the Recall Answer);
9. It is sent by TIPS to the sender of the negative Recall Answer in case of errors (e.g. missing access rights);
10. It is sent by TIPS to inform the Single Instructing Party about the result of the settlement (i.e. settled, rejected, timed-out) in the SIP settlement model;
11. It is sent by TIPS to the Beneficiary Participant in case of timeout condition triggered by TIPS during the settlement phase due to missing positive confirmation from the Beneficiary Participant;

12. It is sent by TIPS to the Beneficiary Participant in case of timeout condition triggered by TIPS during the settlement phase due to delayed positive confirmation from the Beneficiary Participant.

References/links

The schema and the related documentation in XSD/EXCEL/PDF format as well as the message examples are provided within the MyStandards repository under the following link:

<https://www.swift.com/mystandards/TIPS/pacs.002.001.10>

Table 83 – pacs.002.001.10

| Field Name | Description | XML path | Mand. | TIPS Usage |
|---------------------------------|---|--|-------|---|
| Message Identification | The Identification of the message. | FIToFIPmtStsRpt/GrpHdr/Msgld | Yes | Only schema validation is performed. |
| Creation Date Time | Date and time at which the message was created. | FIToFIPmtStsRpt/GrpHdr/CreDtTm | Yes | Only schema validation is performed. |
| Instructing Agent | Agent that instructs the next party in the chain to carry out the instruction. | FIToFIPmtStsRpt/GrpHdr/InstgAgt | No | Only schema validation is performed. |
| Instructed Agent | Agent that is instructed by the previous party in the chain to carry out the instruction. | FIToFIPmtStsRpt/GrpHdr/InstdAgt | No | Only schema validation is performed. |
| Original Message Identification | Message Identification of the originating message | FIToFIPmtStsRpt/OrgnlGrpInfAndSts/OrgnlMsgld | Yes | This field matches with the Identification of the original message. Business cases 1,2,3,6,10,11: FIToFICstmrCdtTrf/GrpHdr/Msgld Business case 4,12: FIToFIPmtStsRpt/GrpHdr/Msgld Business case 5: FIToFIPmtStsReq/GrpHdr/Msgld Business case 7: FIToFIPmtCxlReq/Assgnmt/ld Business case 8: PmtRtr/GrpHdr/Msgld Business case 9: RsltOfInvstgtn/Assgnmt/ld |

| Field Name | Description | XML path | Mand. | TIPS Usage |
|--------------------------------------|---|---|-------|---|
| Original Message Name Identification | Message identifier of the originating message | FIToFIPmtStsRpt/OrgnlGrpInfAndSts/OrgnlMsgNmld | Yes | Business cases 1,2,3,6,10,11: pacs.008.001.08 Business cases 4,12: pacs.002.001.10 Business case 5: pacs.028.001.03 Business case 7: camt.056.001.08 Business case 8: pacs.004.001.09 Business case 9: camt.029.001.09 |
| Group Status Transaction Status | The type of "R" message | FIToFIPmtStsRpt/OrgnlGrpInfAndSts/GrpSts FIToFIPmtStsRpt/TxInfAndSts/TxSts | No | Either Group Status or Transaction Status must be used. If incoming pacs.002 from beneficiary does not include any status or both are filled in, connected payment transaction will be rejected by TIPS. In outgoing pacs.002 messages produced by TIPS, Group Status will be used for positive confirmation while Transaction Status will be included for negative acknowledgements, |
| Reason | The reason code for non-acceptance of the Transaction | FIToFIPmtStsRpt/OrgnlGrpInfAndSts/StsRsnInf/Rsn/Cd | No | This field is used for negative confirmation message only. |
| Transaction Information And Status | Information concerning the original transactions, to which the status report message refers. | FIToFIPmtStsRpt/TxInfAndSts | No | Only one occurrence is allowed |
| Status Identification | The specific reference of the party initiating the Reject | FIToFIPmtStsRpt/TxInfAndSts/StsId | No | For positive confirmation it is the Beneficiary Bank's reference of the SCT ^{Inst} Transaction. For negative confirmation it is the specific reference of the party initiating the Reject. |
| Original Instruction Identification | Unique identification, as assigned by the original Instructing Party for the original instructed party. | FIToFIPmtStsRpt/TxInfAndSts/OrgnlInstrId | No | Only schema validation is performed. |

| Field Name | Description | XML path | Mand. | TIPS Usage |
|-------------------------------------|--|---|-------|--|
| Original End To End Identification | The Originator's reference of the Transaction | FIToFIPmtStsRpt/TxInfAndSts/OrgnlEndToEndId | No | Only schema validation is performed. |
| Original Transaction Identification | The Originator Bank's reference number of the Transaction message | FIToFIPmtStsRpt/TxInfAndSts/OrgnlTxId | Yes | Reference of the Payment Transaction to which the PaymentStatusReport refers. |
| Original UETR | UETR number of the Transaction message | FIToFIPmtStsRpt/TxInfAndSts/OrgnlUETR | No | Only schema validation is performed. |
| Originator | The Identification of the type of party initiating the "R" message | FIToFIPmtStsRpt/OrgnlGrpInfAndSts/StsRsnInf/Orgtr FIToFIPmtStsRpt/TxInfAndSts/StsRsnInf/Orgtr | No | These fields are mandatory for negative confirmation message, not allowed otherwise. |
| Reason | The reason code for non-acceptance of the Transaction | FIToFIPmtStsRpt/TxInfAndSts/StsRsnInf/Rsn/Cd | No | This field is used for negative confirmation message only. |
| Acceptance Timestamp | Timestamp of the Transaction | FIToFIPmtStsRpt/TxInfAndSts/AcceptncDtTm | No | Only schema validation is performed. |
| Original Transaction Reference | Set of key elements used to identify the original transaction that is being referred to. | FIToFIPmtStsRpt/TxInfAndSts/OrgnlTxRef | Yes | Only schema validation is performed. |
| Scheme Identification Code | The identification code of the Scheme | FIToFIPmtStsRpt/TxInfAndSts/OrgnlTxRef/PmtTpInf/SvcLvl/Cd FIToFIPmtStsRpt/TxInfAndSts/OrgnlTxRef/PmtTpInf/LclInstrm/Cd | No | Only schema validation is performed. |
| Category Purpose | The category purpose of the Instruction | FIToFIPmtStsRpt/TxInfAndSts/OrgnlTxRef/PmtTpInf/CtgyPurp | No | Only schema validation is performed. |
| Originator BIC | The BIC code of the Originator Bank | FIToFIPmtStsRpt/TxInfAndSts/OrgnlTxRef/DbtrAgt/FinInstnId/BICFI | Yes | |

3.3.2.1.6 FIToFICustomerCreditTransfer (pacs.008.001.08)

The FIToFICustomerCreditTransfer message allows instructing TIPS for an Instant Payment transaction of a positive amount of money from the originator participant account to the beneficiary participant account for non-Euro settlement models.

References/links

The schema and the related documentation in XSD/EXCEL/PDF format as well as the message examples are provided within the MyStandards repository under the following link:

<https://www.swift.com/mystandards/TIPS/pacs.008.001.08>

Table 84 – pacs.008.001.08

| Field Name | Description | XML path | Mand. | TIPS Usage |
|---|---|---|-------|---|
| Message Identification | Point to point reference, as assigned by the instructing party. | FIToFICstmrCdtTrf/GrpHdr/MsgId | Yes | Only schema validation is performed. |
| Creation Date Time | Date and time at which the message was created. | FIToFICstmrCdtTrf/GrpHdr/CreDtTm | Yes | Only schema validation is performed. |
| Number Of Transactions | Number of individual transactions contained in the message. | FIToFICstmrCdtTrf/GrpHdr/NbOfTxs | Yes | Possible values are checked within schema validation. |
| Total Interbank Settlement Amount | Total amount of money moved between the instructing agent and the instructed agent. | FIToFICstmrCdtTrf/GrpHdr/TtlIntrBkSttlmAmt | No | Only schema validation is performed. |
| Settlement Date | The Settlement Date of the Transaction | FIToFICstmrCdtTrf/GrpHdr/intrBkSttlmDt | No | Only schema validation is performed. |
| Settlement Information | Specifies the details on how the settlement of the transaction between the instructing agent and the instructed agent is completed. | FIToFICstmrCdtTrf/GrpHdr/SttlmInf | Yes | Only schema validation is performed. |
| Settlement Method | Method used to settle the Instant Payment Transaction. | FIToFICstmrCdtTrf/GrpHdr/SttlmInf/SttlmMtd | Yes | Possible values are checked within schema validation. |
| Settlement Account | A specific purpose account used to post debit and credit entries as a result of the transaction. | FIToFICstmrCdtTrf/GrpHdr/SttlmInf/SttlmAcct | No | Only schema validation is performed. |
| Clearing System | Specification of a pre-agreed offering between clearing agents or the channel through which the Instant Payment transaction is processed. | FIToFICstmrCdtTrf/GrpHdr/SttlmInf/ClrSys | No | Only schema validation is performed. |
| Payment Type Information | Set of elements used to further specify the type of transaction. | FIToFICstmrCdtTrf/GrpHdr/PmtTplnf | No | Only schema validation is performed. |
| Scheme Identification Code | The identification code of the Scheme | FIToFICstmrCdtTrf/GrpHdr/PmtTplnf/SvcLvl FIToFICstmrCdtTrf/GrpHdr/PmtTplnf/LclInstrm | No | Possible values are checked within schema validation. |
| Category Purpose | The category purpose of the Instruction | FIToFICstmrCdtTrf/GrpHdr/PmtTplnf/CtgyPurp | No | Only schema validation is performed. |
| Instructing Agent | Agent that instructs the next party in the chain to carry out the instruction. | FIToFICstmrCdtTrf/GrpHdr/instgAgt | No | Only schema validation is performed. |
| Instructed Agent | Agent that is instructed by the previous party in the chain to carry out the instruction. | FIToFICstmrCdtTrf/GrpHdr/instdAgt | No | Only schema validation is performed. |
| Credit Transfer Transaction Information | Set of elements providing information specific to the individual credit transfer. | FIToFICstmrCdtTrf/CdtTrfTxInf | Yes | Only schema validation is performed. |

| Field Name | Description | XML path | Mand. | TIPS Usage |
|--|--|--|-------|---|
| Instruction Identification | Unique identification, as assigned by an instructing party for an instructed party. | FIToFICstmrCdtTrf/CdtTrfTxInf/PmtId/InstrId | No | Only schema validation is performed. |
| End To End Identification | The Originator's reference of the Transaction | FIToFICstmrCdtTrf/CdtTrfTxInf/PmtId/EndToEndId | No | Only schema validation is performed. |
| Transaction Identification | The Originator Bank's reference number of the Transaction message | FIToFICstmrCdtTrf/CdtTrfTxInf/PmtId/TxId | Yes | The Transaction Reference used to identify the Instant Payment transaction and perform the duplicate check |
| UETR | UETR number of the Transaction message | FIToFICstmrCdtTrf/CdtTrfTxInf/PmtId/UETR | No | Only schema validation is performed. |
| Service Level | GPI Service Type Identifiers of the Transaction message | FIToFICstmrCdtTrf/CdtTrfTxInf/PmtTpInf/SvcLvl | No | No |
| Settlement Amount | The amount of the Transaction | FIToFICstmrCdtTrf/CdtTrfTxInf/IntrBkSttlmAmt | Yes | The currency of the Settlement Amount must be the same of the Creditor and Debtor Accounts |
| Acceptance Timestamp | Timestamp of the Transaction | FIToFICstmrCdtTrf/CdtTrfTxInf/AcceptncDtTm | Yes | The Acceptance Timestamp is used as a starting point in time for the Instant Payment transaction processing at Originator Bank level. The Acceptance Timestamp shall be expressed in UTC. |
| Charge Bearer | Specifies which party/parties will bear the charges associated with the processing of the payment transaction. | FIToFICstmrCdtTrf/CdtTrfTxInf/ChrgBr | Yes | Only schema validation is performed. |
| Originator Reference Party Name | The name of the Originator Reference Party | FIToFICstmrCdtTrf/CdtTrfTxInf/UltmtDbtr/Nm | No | Only schema validation is performed. |
| Ultimate Debtor + Postal Address | Ultimate Debtor Postal Address | FIToFICstmrCdtTrf/CdtTrfTxInf/UltmtDbtr/PstlAdr | No | If a Postal Address sub-element other than 'Address Line' and 'Country' is used, then 'Address Line' is forbidden. A combination of Address Line and Country is allowed. If 'Address Line' is not used, then at least Town Name and Country must be used. |
| Originator Reference Party Identification Code | The identification code of the Originator Reference Party | FIToFICstmrCdtTrf/CdtTrfTxInf/UltmtDbtr/Id | No | Only schema validation is performed. |
| Ultimate Debtor ++ Organisation Identification | Unique and unambiguous way to identify an organisation. | FIToFICstmrCdtTrf/CdtTrfTxInf/UltmtDbtr/Id/OrgId | Yes | Only schema validation is performed. |

| Field Name | Description | XML path | Mand. | TIPS Usage |
|---|--|--|-------|---|
| Ultimate Debtor + Identification ++ Private Identification | Unique and unambiguous identification of a person, eg, passport. | FIToFICstmrCdtTrf/CdtTrfTxInf/UltmtDbtr/Id/PrvtId | Yes | Only schema validation is performed. |
| Ultimate Debtor + Country Of Residence | Country Of Residence | FIToFICstmrCdtTrf/CdtTrfTxInf/UltmtDbtr/CtryOfRes | No | Only schema validation is performed. |
| Debtor | Party that owes an amount of money to the (ultimate) creditor. | FIToFICstmrCdtTrf/CdtTrfTxInf/Dbtr | Yes | Only schema validation is performed. |
| Originator Name | The name of the Originator | FIToFICstmrCdtTrf/CdtTrfTxInf/Dbtr/Nm | Yes | Only schema validation is performed. |
| Originator Address | The address of the Originator | FIToFICstmrCdtTrf/CdtTrfTxInf/Dbtr/PstlAdr | No | If a Postal Address sub-element other than 'Address Line' and 'Country' is used, then 'Address Line' is forbidden. A combination of Address Line and Country is allowed. If 'Address Line' is not used, then at least Town Name and Country must be used. |
| Debtor + Postal Address ++ Address Type | Identifies the nature of the postal address | FIToFICstmrCdtTrf/CdtTrfTxInf/Dbtr/PstlAdr/AdrTp | No | Only schema validation is performed. |
| Debtor + Postal Address ++ Department | Identification of a division of a large organisation or building | FIToFICstmrCdtTrf/CdtTrfTxInf/Dbtr/PstlAdr/Dept | No | Only schema validation is performed. |
| Debtor + Postal Address ++ Sub Department | Identification of a sub-division of a large organisation or building | FIToFICstmrCdtTrf/CdtTrfTxInf/Dbtr/PstlAdr/SubDept | No | Only schema validation is performed. |
| Debtor +Postal Address ++Street Name | Name of a street or thoroughfare | FIToFICstmrCdtTrf/CdtTrfTxInf/Dbtr/PstlAdr/StrtNm | No | Only schema validation is performed. |
| Debtor + Postal Address ++ Building Number | Number that identifies the position of a building on a street | FIToFICstmrCdtTrf/CdtTrfTxInf/Dbtr/PstlAdr/BldgNb | No | Only schema validation is performed. |
| Debtor + Postal Address ++ Building Name | Name of the building or house | FIToFICstmrCdtTrf/CdtTrfTxInf/Dbtr/PstlAdr/BldgNm | No | Only schema validation is performed. |
| Debtor + Postal Address ++ Floor | Floor or storey within a building | FIToFICstmrCdtTrf/CdtTrfTxInf/Dbtr/PstlAdr/Flr | No | Only schema validation is performed. |
| Debtor + Postal Address ++ Post Box | Numbered box in a post office, assigned to a person or organisation, where letters are kept until called for | FIToFICstmrCdtTrf/CdtTrfTxInf/Dbtr/PstlAdr/PstBx | No | Only schema validation is performed. |
| Debtor + Postal Address ++ Room | Building room number | FIToFICstmrCdtTrf/CdtTrfTxInf/Dbtr/PstlAdr/Room | No | Only schema validation is performed. |
| Debtor + Postal Address ++ Post Code | Identifier consisting of a group of letters and/or numbers that is added to a postal address to assist the sorting of mail | FIToFICstmrCdtTrf/CdtTrfTxInf/Dbtr/PstlAdr/PstCd | No | Only schema validation is performed. |

| Field Name | Description | XML path | Mand. | TIPS Usage |
|---|---|--|-------|--|
| Debtor + Postal Address ++ Town Name | Name of a built-up area, with defined boundaries, and a local government | FIToFICstmrCdtTrf/CdtTrfTxInf/Dbtr/PstlAdr/TwnNm | No | Only schema validation is performed. |
| Debtor + Postal Address ++ Town Location Name | Specific location name within the town | FIToFICstmrCdtTrf/CdtTrfTxInf/Dbtr/PstlAdr/TwnLctnNm | No | Only schema validation is performed. |
| Debtor + Postal Address ++ District Name | Identifies a subdivision within a country subdivision | FIToFICstmrCdtTrf/CdtTrfTxInf/Dbtr/PstlAdr/DstrctNm | No | Only schema validation is performed. |
| Debtor + Postal Address ++ Country Sub Division | Identifies a subdivision of a country such as state, region, county | FIToFICstmrCdtTrf/CdtTrfTxInf/Dbtr/PstlAdr/CtrySubDvsn | No | Only schema validation is performed. |
| Debtor + Postal Address ++ Country Code | Nation with its own government. | FIToFICstmrCdtTrf/CdtTrfTxInf/Dbtr/PstlAdr/Ctry | No | Only schema validation is performed. |
| Debtor + Postal Address ++ Address Line | Information that locates and identifies a specific address, as defined by postal services, presented in free format text. | FIToFICstmrCdtTrf/CdtTrfTxInf/Dbtr/PstlAdr/AdrLine | No | If 'Address Line' is used, then 'Postal Address' sub-elements other than 'Country' are forbidden. A combination of 'Address Line' and 'Country' is allowed. |
| Originator Identification Code | The Originator identification code | FIToFICstmrCdtTrf/CdtTrfTxInf/Dbtr/Id | No | Only schema validation is performed. |
| Debtor + Identification ++ Organisation Identification | Unique and unambiguous way to identify an organisation | FIToFICstmrCdtTrf/CdtTrfTxInf/Dbtr/Id/Orgld | Yes | Only schema validation is performed. |
| Debtor + Identification ++ Private Identification | Unique and unambiguous identification of a person, eg, passport. | FIToFICstmrCdtTrf/CdtTrfTxInf/Dbtr/Id/Prvtld | Yes | Only schema validation is performed. |
| Debtor + Country Of Residence | Country Of Residence | FIToFICstmrCdtTrf/CdtTrfTxInf/Dbtr/CtryOfRes | No | Only schema validation is performed. |
| Originator Account | The account of the Originator | FIToFICstmrCdtTrf/CdtTrfTxInf/DbtrAcct | No | Only schema validation is performed. |
| Originator Account Identification | Identification of the Originator Account | FIToFICstmrCdtTrf/CdtTrfTxInf/DbtrAcct/Id | Yes | Only schema validation is performed. |
| Originator Account + Type | Originator Account type used for Alias/Proxy | FIToFICstmrCdtTrf/CdtTrfTxInf/DbtrAcct/Tp | No | Only schema validation is performed. |
| Originator Account + Currency | Identification of the currency in which the account is held. | FIToFICstmrCdtTrf/CdtTrfTxInf/DbtrAcct/Ccy | No | Only schema validation is performed. |
| Originator Account + Name | The Alias or Proxy of the account of the Originator. | FIToFICstmrCdtTrf/CdtTrfTxInf/DbtrAcct/Nm | No | Only schema validation is performed. |
| Originator | The Originator Bank | FIToFICstmrCdtTrf/CdtTrfTxInf/DbtrAgt/FinInstnlId | Yes | The Distinguished Name of the sender must be authorised to instruct for the Originator BIC The Originator BIC must be stored as an Account Authorised BIC or CMB user |

| Field Name | Description | XML path | Mand. | TIPS Usage |
|--|--|--|-------|---|
| Beneficiary | The Beneficiary Bank | FIToFICstmrCdtTrf/CdtTrfTxInf/CdtrAgt/FinInstnl d | Yes | The Beneficiary BIC must be linked with at least one Distinguish Name for outbound message routing |
| Creditor | Party to which an amount of money is due. | FIToFICstmrCdtTrf/CdtTrfTxInf/Cdtr | Yes | Only schema validation is performed. |
| Creditor Name | The name of the Beneficiary | FIToFICstmrCdtTrf/CdtTrfTxInf/Cdtr/Nm | No | Only schema validation is performed. |
| Creditor Address | The address of the Beneficiary | FIToFICstmrCdtTrf/CdtTrfTxInf/Cdtr/PstlAdr | No | If a Postal Address sub-element other than 'Address Line' and 'Country' is used, then 'Address Line' is forbidden. A combination of Address Line and Country is allowed. If 'Address Line' is not used, then at least Town Name and Country must be used. |
| Creditor + Postal Address ++ Address Type | Identifies the nature of the postal address | FIToFICstmrCdtTrf/CdtTrfTxInf/Cdtr/PstlAdr/Adr Tp | No | Only schema validation is performed. |
| Creditor + Postal Address ++ Department | Identification of a division of a large organisation or building | FIToFICstmrCdtTrf/CdtTrfTxInf/Cdtr/PstlAdr/Dep t | No | Only schema validation is performed. |
| Creditor + Postal Address ++ Sub Department | Identification of a sub-division of a large organisation or building | FIToFICstmrCdtTrf/CdtTrfTxInf/Cdtr/PstlAdr/Sub Dept | No | Only schema validation is performed. |
| Creditor + Postal Address ++ Street Name | Name of a street or thoroughfare | FIToFICstmrCdtTrf/CdtTrfTxInf/Cdtr/PstlAdr/Strt Nm | No | Only schema validation is performed. |
| Creditor + Postal Address ++ Building Number | Number that identifies the position of a building on a street | FIToFICstmrCdtTrf/CdtTrfTxInf/Cdtr/PstlAdr/Bldg Nb | No | Only schema validation is performed. |
| Creditor + Postal Address ++ Building Name | Name of the building or house | FIToFICstmrCdtTrf/CdtTrfTxInf/Cdtr/PstlAdr/Bldg Nm | No | Only schema validation is performed. |
| Creditor + Postal Address ++ Floor | Floor or storey within a building | FIToFICstmrCdtTrf/CdtTrfTxInf/Cdtr/PstlAdr/Flr | No | Only schema validation is performed. |
| Creditor + Postal Address ++ Post Box | Numbered box in a post office, assigned to a person or organisation, where letters are kept until called for | FIToFICstmrCdtTrf/CdtTrfTxInf/Cdtr/PstlAdr/Pst Bx | No | Only schema validation is performed. |
| Creditor + Postal Address ++ Room | Building room number | FIToFICstmrCdtTrf/CdtTrfTxInf/Cdtr/PstlAdr/Roo m | No | Only schema validation is performed. |
| Creditor + Postal Address ++ Post Code | Identifier consisting of a group of letters and/or numbers that is added to a postal address to assist the sorting of mail | FIToFICstmrCdtTrf/CdtTrfTxInf/Cdtr/PstlAdr/Pst Cd | No | Only schema validation is performed. |

| Field Name | Description | XML path | Mand. | TIPS Usage |
|---|---|--|-------|---|
| Creditor + Postal Address ++ Town Name | Name of a built-up area, with defined boundaries, and a local government | FIToFICstmrCdtTrf/CdtTrfTxInf/Cdtr/PstlAdr/TwnNm | No | Only schema validation is performed. |
| Creditor + Postal Address ++ Town Location Name | Specific location name within the town | FIToFICstmrCdtTrf/CdtTrfTxInf/Cdtr/PstlAdr/TwnLctnNm | No | Only schema validation is performed. |
| Creditor + Postal Address ++ District Name | Identifies a subdivision within a country subdivision | FIToFICstmrCdtTrf/CdtTrfTxInf/Cdtr/PstlAdr/DstrctNm | No | Only schema validation is performed. |
| Creditor + Postal Address ++ Country Sub Division | Identifies a subdivision of a country such as state, region, county | FIToFICstmrCdtTrf/CdtTrfTxInf/Cdtr/PstlAdr/CtrySubDvsn | No | Only schema validation is performed. |
| Creditor + Postal Address ++ Country Code | Nation with its own government. | FIToFICstmrCdtTrf/CdtTrfTxInf/Cdtr/PstlAdr/Ctry | No | Only schema validation is performed. |
| Creditor + Postal Address ++ Address Line | Information that locates and identifies a specific address, as defined by postal services, presented in free format text. | FIToFICstmrCdtTrf/CdtTrfTxInf/Cdtr/PstlAdr/AdrLine | No | If 'Address Line' is used, then 'Postal Address' sub-elements other than 'Country' are forbidden. A combination of 'Address Line' and 'Country' is allowed. |
| Creditor Identification | The Beneficiary identification code | FIToFICstmrCdtTrf/CdtTrfTxInf/Cdtr/Id | No | Only schema validation is performed. |
| Creditor + Identification ++ Organisation Identification | Unique and unambiguous way to identify an organisation | FIToFICstmrCdtTrf/CdtTrfTxInf/Cdtr/Id/Orgld | Yes | Only schema validation is performed. |
| Creditor + Identification ++ Private Identification | Unique and unambiguous identification of a person, e.g. passport. | FIToFICstmrCdtTrf/CdtTrfTxInf/Cdtr/Id/Prvtld | Yes | Only schema validation is performed. |
| Creditor Account | The account of the beneficiary | FIToFICstmrCdtTrf/CdtTrfTxInf/CdtrAcct | No | Only schema validation is performed. |
| Creditor Account Identification | Identification of the Creditor Account | FIToFICstmrCdtTrf/CdtTrfTxInf/CdtrAcct/Id/ | Yes | Only schema validation is performed. |
| Creditor Account + Type | Creditor Account type used for Alias/Proxy | FIToFICstmrCdtTrf/CdtTrfTxInf/CdtrAcct/Tp | No | Only schema validation is performed. |
| Creditor Account + Currency | Identification of the currency in which the account is held. | FIToFICstmrCdtTrf/CdtTrfTxInf/CdtrAcct/Ccy | No | Only schema validation is performed. |
| Creditor Account + Name | The Alias or Proxy of the account of the Creditor. | FIToFICstmrCdtTrf/CdtTrfTxInf/CdtrAcct/Nm | No | Only schema validation is performed. |
| Ultimate Creditor | Ultimate party to which an amount of money is due. | FIToFICstmrCdtTrf/CdtTrfTxInf/UlmtCdtr | No | Only schema validation is performed. |
| Ultimate Creditor Name | The name of the Beneficiary Reference Party | FIToFICstmrCdtTrf/CdtTrfTxInf/UlmtCdtr/Nm | No | Only schema validation is performed. |

| Field Name | Description | XML path | Mand. | TIPS Usage |
|---|---|--|-------|---|
| Ultimate Creditor + Postal Address | Ultimate Creditor Postal Address | FIToFICstmrCdtTrf/CdtTrfTxInf/UltmtCdtR/PstlAdr | No | If a Postal Address sub-element other than 'Address Line' and 'Country' is used, then 'Address Line' is forbidden. A combination of Address Line and Country is allowed. If 'Address Line' is not used, then at least Town Name and Country must be used. |
| Ultimate Creditor Identification | The identification code of the Beneficiary Reference Party | FIToFICstmrCdtTrf/CdtTrfTxInf/UltmtCdtR/Id | No | Only schema validation is performed. |
| Ultimate Creditor + Identification ++ Organisation Identification | Information that locates and identifies a specific address, as defined by postal services, presented in free format text. | FIToFICstmrCdtTrf/CdtTrfTxInf/UltmtCdtR/Id/OrgId | Yes | Only schema validation is performed. |
| Ultimate Creditor + Identification ++ Private Identification | Unique and unambiguous identification of a person, eg, passport. | FIToFICstmrCdtTrf/CdtTrfTxInf/UltmtCdtR/Id/PrvtId | Yes | Only schema validation is performed. |
| Purpose | The purpose of the Instruction | FIToFICstmrCdtTrf/CdtTrfTxInf/Purp | No | Only schema validation is performed. |
| Regulatory Reporting | Information needed due to regulatory and statutory requirements. | FIToFICstmrCdtTrf/CdtTrfTxInf/RgltryRptg | No | Only schema validation is performed. |
| Regulatory Reporting + Debit Credit Reporting Indicator | Information needed due to regulatory and statutory requirements. | FIToFICstmrCdtTrf/CdtTrfTxInf/RgltryRptg/DbtCdtRptgInd | No | Only schema validation is performed. |
| Regulatory Reporting + Authority | Information needed due to regulatory and statutory requirements. | FIToFICstmrCdtTrf/CdtTrfTxInf/RgltryRptg/Authrty | No | Only schema validation is performed. |
| Regulatory Reporting + Details | Information needed due to regulatory and statutory requirements. | FIToFICstmrCdtTrf/CdtTrfTxInf/RgltryRptg/Dtls | No | Only schema validation is performed. |
| Remittance Information | The Remittance Information | FIToFICstmrCdtTrf/CdtTrfTxInf/RmtInf | No | Only schema validation is performed. |
| Remittance Information + Unstructured | Information supplied to enable the matching/reconciliation of an entry with the items that the payment is intended to settle, such as commercial invoices in an account receivable system, in an unstructured form. | FIToFICstmrCdtTrf/CdtTrfTxInf/RmtInf/Ustrd | No | Either Unstructured or Structured may be present. If both components are included, the message will be rejected during the schema validation process. |

| Field Name | Description | XML path | Mand. | TIPS Usage |
|---|--|---|-------|---|
| Remittance Information + Structured | Information supplied to enable the matching/reconciliation of an entry with the items that the payment is intended to settle, such as commercial invoices in an account receivable system, in a structured form. | FIToFICstmrCdtTrf/CdtTrfTxInf/RmtInf/Strd | No | Either Unstructured or Structured may be present. If both components are included, the message will be rejected during the schema validation process. |
| Remittance Information + Structured ++ Referred Document Information | Set of elements used to identify the documents referred to in the remittance information. | FIToFICstmrCdtTrf/CdtTrfTxInf/RmtInf/Strd/Rfrd DocInf | No | Only schema validation is performed. |
| Remittance Information + Structured ++ Referred Document Amount | Set of elements used to provide details on the amounts of the referred document. | FIToFICstmrCdtTrf/CdtTrfTxInf/RmtInf/Strd/Rfrd DocAmt | No | Only schema validation is performed. |
| Remittance Information + Structured ++ Creditor Reference Information | Information supplied to enable the matching/reconciliation of an entry with the items that the payment is intended to settle, such as commercial invoices in an account receivable system, in a structured form. | FIToFICstmrCdtTrf/CdtTrfTxInf/RmtInf/Strd/Cdtr RefInf | No | As the Creditor Bank is not obliged to validate the reference information, TIPS will apply schema validation to this component and included sub-components. |

3.3.2.1.7 PaymentReturn (pacs.004.001.09)

The PaymentReturn message is used for non-Euro settlement models and it is sent by the Assignee Participant as a confirmation for a Recall instructed by the Assigner Participant

Additionally, the PaymentReturn message can be sent in reply to a Request for Status Update on a Recall.

After processing the request, TIPS forwards the PaymentReturn message to the Assigner Participant who formerly instructed the Recall and sends a PaymentStatusReport message to the Assignee Participant.

References/links

The schema and the related documentation in XSD/EXCEL/PDF format as well as the message examples are provided within the MyStandards repository under the following link:

<https://www.swift.com/mystandards/TIPS/pacs.004.001.09>

Table 85 – pacs.004.001.09

| Field Name | Description | XML path | Mand. | TIPS Usage |
|--|---|-------------------------------------|-------|--|
| Message Identification | The Identification of the message. | PmtRtr/GrpHdr/MsgId | Yes | Only schema validation is performed. |
| Creation Date Time | Date and time at which the message was created. | PmtRtr/GrpHdr/CreDtTm | Yes | Only schema validation is performed. |
| Number Of Transactions | Number of individual transactions contained in the message. | PmtRtr/GrpHdr/NbOfTxs | Yes | TIPS supports only one transaction per message. If this field is not 1, the message will be rejected. |
| Total Returned Interbank Settlement Amount | Total amount of money moved. | PmtRtr/GrpHdr/TtlRtrdIntrBkSttlmAmt | Yes | Only schema validation is performed. |
| Interbank Settlement Date | The Settlement Date for the positive answer to the Recall | PmtRtr/GrpHdr/IntrBkSttlmDt | No | Only schema validation is performed. |
| Settlement Method | Method used to settle the Instant Payment Transaction. | PmtRtr/GrpHdr/SttlmInf/SttlmMtd | Yes | Possible values are checked within schema validation. |
| Settlement Account | A specific purpose account used to post debit and credit entries as a result of the transaction. | PmtRtr/GrpHdr/SttlmInf/SttlmAcct | No | Only schema validation is performed. |
| Clearing System | Specification of a pre-agreed offering between clearing agents or the channel through which the Instant Payment transaction is processed. | PmtRtr/GrpHdr/SttlmInf/ClrSys | No | Only schema validation is performed. |
| Instructing Agent | Agent that instructs the next party in the chain to carry out the instruction. | PmtRtr/GrpHdr/InstgAgt | No | Only schema validation is performed. |
| Instructed Agent | Agent that is instructed by the previous party in the chain to carry out the instruction. | PmtRtr/GrpHdr/InstdAgt | No | Only schema validation is performed. |
| Original Group Information | Information concerning the original group of transactions, to which the message refers. | PmtRtr/OrgnlGrpInf | No | Sub-elements of 'Original Group Information' must be present in either 'Original Group Information' or in 'Transaction Information'. If any of these sub-elements is included in both components, message will be rejected. |

| Field Name | Description | XML path | Mand. | TIPS Usage |
|---|---|-------------------------------------|-------|--|
| Original Group Information + Original Message Identification | Point to point reference, as assigned by the original instructing party, to unambiguously identify the original message. | PmtRtr/OrgnlGrpInf/OrgnlMsgld | Yes | This information must be present in either 'Original Group Information' or in 'Transaction Information'. If it is included in both components, message will be rejected. |
| Original Group Information + Original Message Name Identification | Specifies the original message name identifier to which the message refers. Only pacs.008.001.08 is allowed. | PmtRtr/OrgnlGrpInf/OrgnlMsgNmld | Yes | This information must be present in either 'Original Group Information' or in 'Transaction Information'. If it is included in both components, message will be rejected. |
| Transaction Information | Information concerning the original transactions, to which the return message refers. | PmtRtr/TxInf | Yes | TIPS supports only one transaction per message. If more than one Transaction Information block is included, message will be rejected. |
| Return Identification | Unique identification, as assigned by an instructing party for an instructed party, to unambiguously identify the returned transaction. | PmtRtr/TxInf/Rtrld | Yes | TIPS uses this field for the duplicate check |
| Transaction Information + Original Group Information | Information concerning the original group of transactions, to which the message refers. | PmtRtr/TxInf/OrgnlGrpInf | No | Sub-elements of 'Original Group Information' must be present in either 'Original Group Information' or in 'Transaction Information'. If any of these sub-elements is included in both components, message will be rejected. |
| Transaction Information + Original Group Information ++ Original Message Identification | Point to point reference, as assigned by the original instructing party, to unambiguously identify the original message. | PmtRtr/TxInf/OrgnlGrpInf/OrgnlMsgld | Yes | This information must be present in either 'Original Group Information' or in 'Transaction Information'. If it is included in both components, message will be rejected. |

| Field Name | Description | XML path | Mand. | TIPS Usage |
|--|---|---------------------------------------|-------|---|
| Transaction Information + Original Group Information ++ Original Message Name Identification | Specifies the original message name identifier to which the message refers. Only pacs.008.001.08 is allowed. | PmtRtr/TxInf/OrgnlGrpInf/OrgnlMsgNmId | Yes | This information must be present in either 'Original Group Information' or in 'Transaction Information'. If it is included in both components, message will be rejected. |
| Original Instruction Identification | Unique identification, as assigned by the original instructing party for the original instructed party, to unambiguously identify the original instruction. | PmtRtr/TxInf/OrgnlInstrId | No | It is mandatory if provided in the original transaction. Only schema validation is performed. |
| Original End To End Identification | The Originator's reference of the Instruction. | PmtRtr/TxInf/OrgnlEndToEndId | No | Only schema validation is performed. |
| Original Transaction Identification | The Originator Bank's reference of the Transaction message. | PmtRtr/TxInf/OrgnlTxId | No | Only schema validation is performed. |
| Original UETR | UETR number of the Transaction message | PmtRtr/TxInf/OrgnlUETR | No | Only schema validation is performed. |
| Original Interbank Settlement Amount | The amount . | PmtRtr/TxInf/OrgnlIntrBkSttlmAmt | No | Only schema validation is performed. |
| Returned Interbank Settlement Amount | The returned amount of the positive answer to the Recall. | PmtRtr/TxInf/RtrdIntrBkSttlmAmt | Yes | Amount to be settled in TIPS. |
| Returned Instructed Amount | Amount of money to be moved between the debtor and the creditor, before deduction of charges, in the returned transaction. | PmtRtr/TxInf/RtrdInstdAmt | No | Only schema validation is performed. |
| Charge Bearer | Specifies which party/parties will bear the charges associated with the processing of the payment transaction. | PmtRtr/TxInf/ChrgBr | No | Only schema validation is performed. |
| Charges Information + Amount | The fee for the positive answer to a Recall (optional) | PmtRtr/TxInf/ChrgsInf/Amt | No | It is mandatory if Charges Information component is included. Only schema validation is performed. |
| Charges Information + Agent ++ Financial Institution Identification | The BIC code of the Beneficiary Bank. | PmtRtr/TxInf/ChrgsInf/Agf/FinInstnId | No | Only schema validation is performed. |
| Transaction Information + Instructing Agent | Agent that instructs the next party in the chain to carry out the instruction. | PmtRtr/TxInf/InstgAgf | No | Only schema validation is performed. |

| Field Name | Description | XML path | Mand. | TIPS Usage |
|--|---|---|-------|--------------------------------------|
| Transaction Information + Instructed Agent | Agent that is instructed by the previous party in the chain to carry out the instruction. | PmtRtr/TxInf/InstdAgt | No | Only schema validation is performed. |
| Return Reason Information + Originator | The Identification of the type of party initiating the "R" message | PmtRtr/TxInf/RtrRsnInf/Orgtr | Yes | Only schema validation is performed. |
| Return Reason Information + Reason | The reason code for non-acceptance of the Transaction. | PmtRtr/TxInf/RtrRsnInf/Rsn/Cd | Yes | Only schema validation is performed. |
| Return Reason Information + Additional Information | The specific reference of the bank initiating the Recall | PmtRtr/TxInf/RtrRsnInf/AddtlInf | Yes | Only schema validation is performed. |
| Interbank Settlement Date | The Settlement Date of the Transaction. | PmtRtr/TxInf/OrgnITxRef/IntrBkSttlmDt | No | Only schema validation is performed. |
| Settlement Information | Specifies the details on how the settlement of the original transaction between the instructing agent and the instructed agent was completed. | PmtRtr/TxInf/OrgnITxRef/SttlmInf | No | Only schema validation is performed. |
| Scheme Identification Code | The identification code of the Scheme | PmtRtr/TxInf/OrgnITxRef/PmtTpInf/SvcLvl/Cd PmtRtr/TxInf/OrgnITxRef/PmtTpInf/LclInstrm/Cd | No | Only schema validation is performed. |
| Category Purpose | The category purpose of the Instruction. | PmtRtr/TxInf/OrgnITxRef/PmtTpInf/CtgyPurp | No | Only schema validation is performed. |
| Remittance Information | The Remittance information. | PmtRtr/TxInf/OrgnITxRef/RmtInf | No | Only schema validation is performed. |
| Ultimate Debtor + Name | The name of the Originator Reference Party. | PmtRtr/TxInf/OrgnITxRef/UlmtDbtr/Pty/Nm | No | Only schema validation is performed. |
| Ultimate Debtor + Identification | The identification code of the Originator Reference Party. | PmtRtr/TxInf/OrgnITxRef/UlmtDbtr/Pty/Id | No | Only schema validation is performed. |
| Debtor + Name | The name of the Originator. | PmtRtr/TxInf/OrgnITxRef/Dbtr/Pty/Nm | No | Only schema validation is performed. |
| Debtor + Postal Address | The address of the Originator. | PmtRtr/TxInf/OrgnITxRef/Dbtr/Pty/PstlAdr | No | Only schema validation is performed. |
| Debtor + Identification | The Originator identification code. | PmtRtr/TxInf/OrgnITxRef/Dbtr/Pty/Id | No | Only schema validation is performed. |
| Debtor Account | The account of the Originator. | PmtRtr/TxInf/OrgnITxRef/DbtrAcct | No | Only schema validation is performed. |
| Debtor Account Identification | Identification of the Debtor Account | PmtRtr/TxInf/OrgnITxRef/DbtrAcct/Id | Yes | Only schema validation is performed. |
| Debtor Account + Type | Debtor Account type used for Alias/Proxy | PmtRtr/TxInf/OrgnITxRef/DbtrAcct/Tp | No | Only schema validation is performed. |
| Debtor Account + Currency | Identification of the currency in which the account is held. | PmtRtr/TxInf/OrgnITxRef/DbtrAcct/Ccy | No | Only schema validation is performed. |
| Debtor Account + Name | The Alias or Proxy of the account of the Debtor. | PmtRtr/TxInf/OrgnITxRef/DbtrAcct/Nm | No | Only schema validation is performed. |

| Field Name | Description | XML path | Mand. | TIPS Usage |
|------------------------------------|--|--|-------|---|
| Debtor Agent | The BIC code of the Originator Bank. | PmtRtr/TxInf/OrgnITxRef/DbrAgt | No | Only schema validation is performed. This field is used in TIPS for recall answer processing. |
| Creditor Agent | The BIC code of the Beneficiary Bank. | PmtRtr/TxInf/OrgnITxRef/CdtrAgt | No | Only schema validation is performed. This field is used in TIPS for recall answer processing. |
| Creditor + Name | The name of the Beneficiary. | PmtRtr/TxInf/OrgnITxRef/Cdtr/Pty/Nm | No | Only schema validation is performed. |
| Creditor + Postal Address | The address of the Beneficiary. | PmtRtr/TxInf/OrgnITxRef/Cdtr/Pty/PstlAdr | No | Only schema validation is performed. |
| Creditor + Identification | The Beneficiary identification code. | PmtRtr/TxInf/OrgnITxRef/Cdtr/Pty/Id | No | Only schema validation is performed. |
| Creditor Account | The account of the Beneficiary. | PmtRtr/TxInf/OrgnITxRef/CdtrAcct | No | Only schema validation is performed. |
| Creditor Account Identification | Identification of the Creditor Account | PmtRtr/TxInf/OrgnITxRef/CdtrAcct/Id | Yes | Only schema validation is performed. |
| Creditor Account + Type | Creditor Account type used for Alias/Proxy | PmtRtr/TxInf/OrgnITxRef/CdtrAcct/Tp | No | Only schema validation is performed. |
| Creditor Account + Currency | Identification of the currency in which the account is held. | PmtRtr/TxInf/OrgnITxRef/CdtrAcct/Ccy | No | Only schema validation is performed. |
| Creditor Account + Name | The Alias or Proxy of the account of the Creditor. | PmtRtr/TxInf/OrgnITxRef/CdtrAcct/Nm | No | Only schema validation is performed. |
| Ultimate Creditor + Name | Name of the Beneficiary Reference Party. | PmtRtr/TxInf/OrgnITxRef/UltmtCdtr/Pty/Nm | No | Only schema validation is performed. |
| Ultimate Creditor + Identification | Identification code of the Beneficiary Reference Party. | PmtRtr/TxInf/OrgnITxRef/UltmtCdtr/Pty/Id | No | Only schema validation is performed. |
| Purpose | Underlying reason for the payment transaction. | PmtRtr/TxInf/OrgnITxRef/Purp | No | Only schema validation is performed. |

3.3.2.1.8 FIToFIPaymentStatusRequest (pacs.028.001.03)

The FI to FI Payment Status Request message is used for non-Euro settlement models and it allows instructing TIPS for retrieving the status of an Instant Payment transaction.

This message covers the scenario of (i) Status investigation message and (ii) Request for Status Update on a Recall:

- The Originator PSP or Instructing Party can start the investigation process on a previously instructed Instant Payment Transaction;
- The Originator PSP or Instructing Party can start the Request for Status Update on a Recall previously instructed.

References/links

The schema and the related documentation in XSD/EXCEL/PDF format as well as the message examples are provided within the MyStandards repository under the following link:

<https://www.swift.com/mystandards/TIPS/pacs.028.001.03>

Table 86 – Status investigation Message pacs.028.001.03

| Field Name | Description | XML path | Mand. | TIPS Usage |
|--------------------------------------|--|---|-------|---|
| Message Identification | Point to point reference, as assigned by the instructing party. | FIToFIPmtStsReq/GrpHdr/MsgId | Yes | Only schema validation is performed. |
| Creation Date Time | Date and time at which the message was created. | FIToFIPmtStsReq/GrpHdr/CreDtTm | Yes | Only schema validation is performed. |
| Instructing Agent | Agent that instructs the next party in the chain to carry out the instruction. | FIToFIPmtStsReq/GrpHdr/InstgAgt | No | Only schema validation is performed. |
| Instructed Agent | Agent that is instructed by the previous party in the chain to carry out the instruction. | FIToFIPmtStsReq/GrpHdr/InstdAgt | No | Only schema validation is performed. |
| Original Message Identification | Message Identification of the originating message | FIToFIPmtStsReq/OrgnlGrpInf/OrgnlMsgId | No | Only schema validation is performed. |
| Original Message Name Identification | Message identifier of the originating message | FIToFIPmtStsReq/OrgnlGrpInf/OrgnlMsgNmId | No | Possible allowed value: - pacs.008.001.08 |
| Status Request Identification | Unique identification, as assigned by an instructing party for an instructed party. | FIToFIPmtStsReq/TxInf/stsReqId | No | Only schema validation is performed. |
| Original Instruction Identification | Unique identification, as assigned by the original instructing party for the original instructed party | FIToFIPmtStsReq/TxInf/OrgnlInstrId | No | Only schema validation is performed. |
| Original End To End Identification | The Originator's reference of the Transaction | FIToFIPmtStsReq/TxInf/OrgnlEndToEndId | No | Only schema validation is performed. |
| Transaction Identification | The Originator Bank's reference number of the Transaction message | FIToFIPmtStsReq/TxInf/OrgnlTxId | Yes | Identification of the Payment Transaction to be investigated. |
| Original UETR | UETR number of the Transaction message | FIToFIPmtStsReq/TxInf/OrgnlUETR | No | Only schema validation is performed. |
| Acceptance Timestamp | Timestamp of the Transaction | FIToFIPmtStsReq/TxInf/AcceptncDtTm | No | Acceptance timestamp of the Payment Transaction to be investigated. |
| Category Purpose | The category purpose of the Instruction | FIToFIPmtStsReq/TxInf/OrgnlTxRef/PmtTpInf/CtgyPurp | No | Only schema validation is performed. |
| Scheme Identification Code | The identification code of the Scheme | FIToFIPmtStsReq/TxInf/OrgnlTxRef/PmtTpInf/SvcLvl/Cd FIToFIPmtStsReq/TxInf/OrgnlTxRef/PmtTpInf/Lcllnstrm/Cd | Yes | Only schema validation is performed. |

| Field Name | Description | XML path | Mand. | TIPS Usage |
|----------------|-------------------------------------|---|-------|--|
| Originator BIC | The BIC code of the Originator Bank | FIToFIPmtStsReq/TxInf/OrgnITxRef/DbtrAgt/FinInstnId/BICFI | Yes | This field is used in combination with the requestor Distinguish Name to check user access rights. |

Table 87 – Request for Status Update on a Recall pacs.028.001.03

| Field Name | Description | XML path | Mand. | TIPS Usage |
|--------------------------------------|---|---|-------|--|
| Message Identification | Point to point reference, as assigned by the instructing party. | FIToFIPmtStsReq/GrpHdr/MsgId | Yes | Only schema validation is performed. |
| Creation Date Time | Date and time at which the message was created. | FIToFIPmtStsReq/GrpHdr/CreDtTm | Yes | Only schema validation is performed. |
| Instructing Agent | Agent that instructs the next party in the chain to carry out the instruction. | FIToFIPmtStsReq/GrpHdr/InstgAgt | No | Only schema validation is performed. |
| Instructed Agent | Agent that is instructed by the previous party in the chain to carry out the instruction. | FIToFIPmtStsReq/GrpHdr/InstdAgt | No | Only schema validation is performed. |
| Original Message Identification | Message Identification of the originating message | FIToFIPmtStsReq/OrgnGrpInf/OrgnMsgId | No | Only schema validation is performed. |
| Original Message Name Identification | Message identifier of the originating message | FIToFIPmtStsReq/OrgnGrpInf/OrgnMsgNmId | No | Possible allowed value is: - camt.056.001.08 |
| Status Request Identification | Unique identification, as assigned by an instructing party for an instructed party. | FIToFIPmtStsReq/TxInf/stsReqId | No | Only schema validation is performed. |
| Original Instruction Identification | Cancellation ID of the relevant camt.056 Transaction Information. | FIToFIPmtStsReq/TxInf/OrgnInstrId | No | If not present, the message will be rejected during the schema validation process. |
| Original End To End Identification | The Originator's reference of the Transaction | FIToFIPmtStsReq/TxInf/OrgnEndToEndId | No | Only schema validation is performed. |
| Transaction Identification | The Originator Bank's reference number of the Transaction message | FIToFIPmtStsReq/TxInf/OrgnTxId | Yes | Identification of the Payment Transaction to be investigated. |
| Original UETR | UETR number of the Transaction message | FIToFIPmtStsReq/TxInf/OrgnUETR | No | Only schema validation is performed. |
| Acceptance Timestamp | Timestamp of the Transaction | FIToFIPmtStsReq/TxInf/AcceptncDtTm | No | Acceptance timestamp of the Payment Transaction to be investigated. |
| Original Transaction Reference | Same values as the message elements of the original instruction. | FIToFIPmtStsReq/TxInf/OrgnITxRef | Yes | Only schema validation is performed. |
| Settlement Amount | Amount. | FIToFIPmtStsReq/TxInf/OrgnITxRef/IntrBkSttlmAmt | No | Only schema validation is performed. |

| Field Name | Description | XML path | Mand. | TIPS Usage |
|--|---|--|-------|--|
| Settlement Date | The Settlement Date of the Transaction. | FIToFIPmtStsReq/TxInf/OrgnTxRef/IntrBkSttlmDt | No | Only schema validation is performed. |
| Settlement Information | Specifies the details on the settlement. | FIToFIPmtStsReq/TxInf/OrgnTxRef/SttlmInf | No | Only schema validation is performed. |
| Scheme Identification Code | The identification code of the Scheme | FIToFIPmtStsReq/TxInf/OrgnTxRef/PmtTplnf/SvcLv/Cd FIToFIPmtStsReq/TxInf/OrgnTxRef/PmtTplnf/Lcllnstrm/Cd | Yes | Only schema validation is performed. |
| Category Purpose | The category purpose of the Instruction | FIToFIPmtStsReq/TxInf/OrgnTxRef/PmtTplnf/CtgyPurp | No | Only schema validation is performed. |
| Remittance Information | The Remittance information. | FIToFIPmtStsReq/TxInf/OrgnTxRef/RmtInf | No | Only schema validation is performed. |
| Originator Reference Party Name | The name of the Originator Reference Party | FIToFIPmtStsReq/TxInf/OrgnTxRef/UltmtDbtr/Pty/Nm | No | Only schema validation is performed. |
| Originator Reference Party Identification Code | The identification code of the Originator Reference Party | FIToFIPmtStsReq/TxInf/OrgnTxRef/UltmtDbtr/Pty/Id | No | Only schema validation is performed. |
| Debtor + Name | The name of the Originator. | FIToFIPmtStsReq/TxInf/OrgnTxRef/Dbtr/Pty/Nm | No | Only schema validation is performed. |
| Debtor + Postal Address | The address of the Originator. | FIToFIPmtStsReq/TxInf/OrgnTxRef/Dbtr/Pty/PstlAdr | No | Only schema validation is performed. |
| Debtor + Identification | The Originator identification code. | FIToFIPmtStsReq/TxInf/OrgnTxRef/Dbtr/Pty/Id | No | Only schema validation is performed. |
| Debtor Account | The account of the Originator. | FIToFIPmtStsReq/TxInf/OrgnTxRef/DbtrAcct | No | Only schema validation is performed. |
| Debtor Account Identification | Identification of the Originator Account | FIToFIPmtStsReq/TxInf/OrgnTxRef/DbtrAcct/Id | Yes | Only schema validation is performed. |
| Debtor Account + Type | Debtor Account type used for Alias/Proxy | FIToFIPmtStsReq/TxInf/OrgnTxRef/DbtrAcct/Tp | No | Only schema validation is performed. |
| Debtor Account + Name | The Alias or Proxy of the account of the Debtor. | FIToFIPmtStsReq/TxInf/OrgnTxRef/DbtrAcct/Nm | No | Only schema validation is performed. |
| Debtor Agent | The BIC code of the Originator Bank | FIToFIPmtStsReq/TxInf/OrgnTxRef/DbtrAgt/FinInstnId/BICFI | Yes | This field is used in combination with the requestor Distinguish Name to check user access rights. |
| Creditor Agent | The BIC code of the Beneficiary Bank. | FIToFIPmtStsReq/TxInf/OrgnTxRef/CdtrAgt/FinInstnId/BICFI | No | This field is used to forward the request. If not present, the message will be rejected during the schema validation process. Multiple instances of Transaction Information must report the same Creditor Agent BIC. Otherwise the message will be rejected by TIPS. |

| Field Name | Description | XML path | Mand. | TIPS Usage |
|------------------------------------|---|--|-------|--------------------------------------|
| Creditor + Name | The name of the Beneficiary. | FIToFIPmtStsReq/TxInf/OrgnTxRef/Cdtr/Pty/Nm | No | Only schema validation is performed. |
| Creditor + Postal Address | The address of the Beneficiary. | FIToFIPmtStsReq/TxInf/OrgnTxRef/Cdtr/Pty/PstlAdr | No | Only schema validation is performed. |
| Creditor + Identification | The Beneficiary identification code. | FIToFIPmtStsReq/TxInf/OrgnTxRef/Cdtr/Pty/Id | No | Only schema validation is performed. |
| Creditor Account | The account of the Beneficiary. | FIToFIPmtStsReq/TxInf/OrgnTxRef/CdtrAcct | No | Only schema validation is performed. |
| Creditor Account Identification | Identification of the Beneficiary Account | FIToFIPmtStsReq/TxInf/OrgnTxRef/CdtrAcct/Id | Yes | Only schema validation is performed. |
| Creditor Account + Type | Creditor Account type used for Alias/Proxy | FIToFIPmtStsReq/TxInf/OrgnTxRef/CdtrAcct/Tp | No | Only schema validation is performed. |
| Creditor Account + Name | The Alias or Proxy of the account of the Creditor. | FIToFIPmtStsReq/TxInf/OrgnTxRef/CdtrAcct/Nm | No | Only schema validation is performed. |
| Ultimate Creditor + Name | Name of the Beneficiary Reference Party. | FIToFIPmtStsReq/TxInf/OrgnTxRef/UltmtCdtr/Pty/Nm | No | Only schema validation is performed. |
| Ultimate Creditor + Identification | Identification code of the Beneficiary Reference Party. | FIToFIPmtStsReq/TxInf/OrgnTxRef/UltmtCdtr/Pty/Id | No | Only schema validation is performed. |

3.3.2.2. Cash Management (camt)

3.3.2.2.1 GetAccount (camt.003.001.06)

This message is sent by a TIPS Participant, Ancillary System or Instructing Party to TIPS to instruct the following queries:

- Account Balance and Status Query;
- CMB Limit and Status Query.

The table describes the message elements to be filled.

References/links

The schema and the related documentation in XSD/EXCEL/PDF format as well as the message examples are provided within the MyStandards repository under the following link:

<https://www.swift.com/mystandards/TIPS/camt.003.001.06>

Table 88 – GetAccount (camt.003.001.06)

| Field Name | Description | XML path | Mand. | TIPS Usage |
|--------------------|-------------------------------|----------------------|-------|---|
| Message Identifier | Identification of the message | GetAcct/MsgHdr/MsgId | Yes | This information will be included in the resulting camt.004 |

| Field Name | Description | XML path | Mand. | TIPS Usage |
|---------------------------|--|--|-------|--|
| Account or CMB Identifier | Identification of the Account or CMB to query | GetAcct/AcctQryDef/AcctCrit/NewCrit/SchCrit/AcctId/EQ/Othr/Id | Yes | |
| Account User | Identification of either the BIC of the Authorised Account User of the Account/CMB, or the BIC of the owner of the Account/CMB to query, depending on the access right profile of the requestor. | GetAcct/AcctQryDef/AcctCrit/NewCrit/SchCrit/AcctOwnr/Id/OrgId/AnyBIC | Yes | TIPS uses this BIC in combination with the Distinguished Name to derive access rights granted to the requestor |

3.3.2.2.2 ReturnAccount (camt.004.001.07)

This message is sent by TIPS to the interested TIPS Participant, Ancillary System or Instructing Party in the following business cases:

- Account Balance and Status Query response;
- CMB Limit and Status Query response;
- Query response error;
- Account Floor and Ceiling notifications;
- CMB Floor and Ceiling notifications.

The message content differs depending on the business case. All the optional fields which are out of the related table will not be included in the message.

References/links

The schema and the related documentation in XSD/EXCEL/PDF format as well as the message examples are provided within the MyStandards repository under the following link:

<https://www.swift.com/mystandards/TIPS/camt.004.001.07>

Table 89 – Account Balance and Status Query response

| Field Name | Description | XML path | Mand. | TIPS Usage |
|--|---|----------------------------------|-------|--|
| Message Identifier | Identification of the message assigned by TIPS | RtrAcct/MsgHdr/MsgId | Yes | |
| Timestamp of the Query | Timestamp assigned when retrieval of records has been performed | RtrAcct/MsgHdr/CreDtTm | Yes | |
| Original Query Message Identifier | Identification of the originating query message | RtrAcct/MsgHdr/OrgnlBizQry/MsgId | Yes | Field is filled with originating Message Identifier when the camt.004 is a query response. |
| Fields reported for account for which no errors are triggered | | | | |

| Field Name | Description | XML path | Mand. | TIPS Usage |
|--|---|--|-------|---|
| TIPS Account Identifier | Account identifier retrieved from reference data repository | RtrAcct/RptOrErr/AcctRpt/AcctId/Othr/Id | Yes | |
| Currency | Currency for which the returned account is issued | RtrAcct/RptOrErr/AcctRpt/AcctOrErr/Acct/Ccy | Yes | |
| TIPS Participant Identifier | BIC code of the account owner | RtrAcct/RptOrErr/AcctRpt/AcctOrErr/Acct/Ownr/Id/OrgId/AnyBIC | Yes | Field is always filled when the camt.004 is a response for Account Balance and Status query |
| Current Balance | Current balance of the account | RtrAcct/RptOrErr/AcctRpt/AcctOrErr/Acct/MulBal/Amt | Yes | The balance is the sum of unreserved and reserved balances |
| Credit Debit Indicator | Specifies if balance is below or above zero | RtrAcct/RptOrErr/AcctRpt/AcctOrErr/Acct/MulBal/CdtDbtInd | Yes | As negative balances are not foreseen for accounts, only the value CRDT is expected for them. The value DBIT could be used in queries coming from RTGS Systems for transit accounts, in case of a negative balance. |
| Account Status | Status details for the retrieved account | RtrAcct/RptOrErr/AcctRpt/AcctOrErr/Acct/MulBal/RstrctnTp | No | This message component is included only if the account is blocked |
| Restriction Type Identification | Restriction Type identifier applied to the account | RtrAcct/RptOrErr/AcctRpt/AcctOrErr/Acct/MulBal/RstrctnTp/Id | Yes | Restriction Type code. If not provided, this field must be filled with BLCK |
| Processing Type | Specifies the processing type for the restriction type applied to the account | RtrAcct/RptOrErr/AcctRpt/AcctOrErr/Acct/MulBal/RstrctnTp/PrcgTp/Cd | Yes | Filled with BLCK |
| Fields reported for account for which at least one error is triggered | | | | |
| Business Error | Specifies the error occurred when processing the originating query message | RtrAcct/RptOrErr/AcctRpt/AcctOrErr/BizErr/Err/Prtry | Yes | |
| Business Error Description | Provides with additional error description | RtrAcct/RptOrErr/AcctRpt/AcctOrErr/BizErr/Desc | No | |

Table 90 – CMB Limit and Status Query response

| Field Name | Description | XML path | Mand. | TIPS Usage |
|------------------------|---|------------------------|-------|------------|
| Message Identifier | Identification of the message assigned by TIPS | RtrAcct/MsgHdr/MsgId | Yes | |
| Timestamp of the Query | Timestamp assigned when retrieval of records has been performed | RtrAcct/MsgHdr/CreDtTm | Yes | |

| Field Name | Description | XML path | Mand. | TIPS Usage |
|--|---|---|-------|---|
| Original Query Message Identifier | Identification of the originating query message | RtrAcct/MsgHdr/OrgnlBizQry/MsgId | Yes | Field is filled with originating Message Identifier when the camt.004 is a query response. |
| Fields reported for CMB for which no errors are triggered | | | | |
| TIPS Account Identifier | Account identifier retrieved from reference data repository | RtrAcct/RptOrErr/AcctRpt/AcctId/Othr/Id | Yes | |
| Currency | Currency of the account linked to the returned CMB | RtrAcct/RptOrErr/AcctRpt/AcctOrErr/Acct/Ccy | Yes | |
| TIPS Participant Identifier | BIC code of the CMB user | RtrAcct/RptOrErr/AcctRpt/AcctOrErr/Acct/CurBilLmt/CtrPtyId/FinInstnId/BICFI | Yes | |
| TIPS CMB Identifier | Identification of the CMB | RtrAcct/RptOrErr/AcctRpt/AcctOrErr/Acct/Nm | Yes | Field is always filled |
| CMB Limit | Limit amount of the CMB for the counterparty | RtrAcct/RptOrErr/AcctRpt/AcctOrErr/Acct/CurBilLmt/LmtAmt | Yes | |
| Credit Debit Indicator | Specifies if limit which has been set up for the CMB is below or above zero | RtrAcct/RptOrErr/AcctRpt/AcctOrErr/Acct/CurBilLmt/CdtDbtInd | Yes | |
| CMB Headroom | Dynamic headroom of the CMB limit | RtrAcct/RptOrErr/AcctRpt/AcctOrErr/Acct/CurBilLmt/BilBal/Amt | Yes | |
| Credit Debit Indicator | Specifies if the current headroom for the CMB is below or above zero | RtrAcct/RptOrErr/AcctRpt/AcctOrErr/Acct/CurBilLmt/BilBal/CdtDbtInd | Yes | As negative limits are not foreseen, only the value CRDT is expected |
| CMB Status | Specifies the status of the CMB | RtrAcct/RptOrErr/AcctRpt/AcctOrErr/Acct/CurBilLmt/BilBal/Tp/Cd | No | This field is filled only if the CMB is blocked. It must be filled with one of the following values: - BLCK : Blocked for credit and debit - CRDT : Blocked for credit - DBIT : Blocked for debit |
| Fields reported for CMB for which at least one error is triggered | | | | |
| Business Error | Specifies the error occurred when processing the originating query message | RtrAcct/RptOrErr/AcctRpt/AcctOrErr/BizErr/Err/Prt | Yes | |
| Business Error Description | Provides with additional error description | RtrAcct/RptOrErr/AcctRpt/AcctOrErr/BizErr/Desc | No | |

Table 91 – Query response error

| Field Name | Description | XML path | Mand. | TIPS Usage |
|------------------------|---|------------------------|-------|------------|
| Message Identifier | Identification of the message assigned by TIPS | RtrAcct/MsgHdr/MsgId | Yes | |
| Timestamp of the Query | Timestamp assigned when retrieval of records has been performed | RtrAcct/MsgHdr/CreDtTm | Yes | |

| Field Name | Description | XML path | Mand. | TIPS Usage |
|-----------------------------------|--|---|-------|---|
| Original Query Message Identifier | Identification of the originating query message | RtrAcct/MsgHdr/OrgnlBizQry/Msgld | Yes | Field is always filled when the camt.004 is a query response. |
| TIPS Account Identifier | Account identifier retrieved from reference data repository | RtrAcct/RptOrErr/AcctRpt/AcctId/Othr/Id | Yes | |
| Business Error | Specifies the error occurred when processing the originating query message | RtrAcct/RptOrErr/AcctRpt/AcctOrErr/BizErr/Err/Prtry | Yes | |
| Business Error Description | Provides with additional error description | RtrAcct/RptOrErr/AcctRpt/AcctOrErr/BizErr/Desc | No | |

Table 92 – CMB Floor and Ceiling notification

| Field Name | Description | XML path | Mand. | TIPS Usage |
|-----------------------------------|--|---|-------|---|
| Message Identifier | Identification of the message assigned by TIPS | RtrAcct/MsgHdr/Msgld | Yes | |
| Timestamp of the Notification | Timestamp assigned when notification has been triggered | RtrAcct/MsgHdr/CreDtTm | Yes | |
| Original Query Message Identifier | Identification of the originating query message | RtrAcct/MsgHdr/OrgnlBizQry/Msgld | Yes | Field is not required by the business case and will be filled with "NOTPROVIDED" |
| TIPS Account Identifier | Account identifier retrieved from reference data repository | RtrAcct/RptOrErr/AcctRpt/AcctId/Othr/Id | Yes | |
| Currency | Currency of the account linked to the related CMB | RtrAcct/RptOrErr/AcctRpt/AcctOrErr/Acct/Ccy | Yes | |
| TIPS Participant Identifier | BIC code of the CMB user | RtrAcct/RptOrErr/AcctRpt/AcctOrErr/Acct/CurBilLmt/CtrPtyId/FinInstnId/BICFI | Yes | |
| TIPS CMB Identifier | Identification of the CMB | RtrAcct/RptOrErr/AcctRpt/AcctOrErr/Acct/Nm | Yes | Field is always filled |
| CMB Limit | Limit amount of the CMB for the counterparty | RtrAcct/RptOrErr/AcctRpt/AcctOrErr/Acct/CurBilLmt/LmtAmt | Yes | The field is filled by TIPS as it is mandatory, but the value will always be 0, independently of the real value, as not relevant for the business case. |
| CMB Headroom | Dynamic headroom of the CMB limit | RtrAcct/RptOrErr/AcctRpt/AcctOrErr/Acct/CurBilLmt/BilBal/Amt | Yes | |
| Credit Debit Indicator | Specifies if the current headroom for the CMB is below or above zero | RtrAcct/RptOrErr/AcctRpt/AcctOrErr/acct/CurBilLmt/BilBal/CdtDbtInd | Yes | As negative limits are not foreseen, only the value CRDT is expected |

Table 93 – Account Floor and Ceiling notification

| Field Name | Description | XML path | Mand. | TIPS Usage |
|-----------------------------------|---|---|-------|---|
| Message Identifier | Identification of the message assigned by TIPS | RtrAcct/MsgHdr/MsgId | Yes | |
| Timestamp of the Notification | Timestamp assigned when notification has been triggered | RtrAcct/MsgHdr/CreDtTm | Yes | |
| Original Query Message Identifier | Identification of the originating query message | RtrAcct/MsgHdr/OrgnlBizQry/MsgId | Yes | Field is not required by the business case. A "NOTPROVIDED" will be included in the field. |
| TIPS Account Identifier | Account identifier retrieved from reference data repository | RtrAcct/RptOrErr/AcctRpt/AcctId/Othr/Id | Yes | |
| Currency | Currency for which the returned account is issued | RtrAcct/RptOrErr/AcctRpt/AcctOrErr/Acct/Ccy | Yes | |
| TIPS Participant Identifier | BIC code of the account owner | RtrAcct/RptOrErr/AcctRpt/AcctOrErr/Acct/Ownr/Id /OrgId/AnyBIC | Yes | Field is always filled when the camt.004 is a response for Account Balance and Status query |
| Current Balance | Current balance of the account | RtrAcct/RptOrErr/AcctRpt/AcctOrErr/Acct/MulBal/Amt | Yes | The balance is the sum of unreserved and reserved balances |
| Credit Debit Indicator | Specifies if balance is below or above zero | RtrAcct/RptOrErr/AcctRpt/AcctOrErr/Acct/MulBal/CdtDbtInd | Yes | As negative balances are not foreseen, only the value CRDT is expected |

3.3.2.2.3 GetTransaction (camt.005.001.07)

This message is sent by the TIPS actor to TIPS to instruct a Payment transaction status query.

The following table describes the message elements to be filled.

References/links

The schema and the related documentation in XSD/EXCEL/PDF format as well as the message examples are provided within the MyStandards repository under the following link:

<https://www.swift.com/mystandards/TIPS/camt.005.001.07>

Table 94 – GetTransaction (camt.005.001.07)

| Field Name | Description | XML path | Mand. | TIPS Usage |
|--------------------|-------------------------------|-----------------------------|-------|---|
| Message Identifier | Identification of the message | GetTx/MsgHdr/MsgId | Yes | This information will be included in the resulting camt.006 |
| Request Type | Type of the request | GetTx/MsgHdr/ReqTp/Prtry/Id | Yes | Allowed value: - INPA : for Payment |

| Field Name | Description | XML path | Mand. | TIPS Usage |
|----------------------------|--|--|-------|---|
| | | | | transaction status query |
| Debtor | BIC of the debtor of the searched IP Transaction | GetTx/TxQryDef/TxCrit/NewCrit/SchCrit/PmtFr/Mmbld/FinInstnId/BICFI | Yes | |
| Transaction Identification | Identification of the Instant Payment Transaction to be found. | GetTx/TxQryDef/TxCrit/NewCrit/SchCrit/PmtSch/TxId | Yes | pacs.008 Transaction Identification or pacs.004 Return Identification |

3.3.2.2.4 ReturnTransaction (camt.006.001.07)

This message is sent by TIPS to the interested TIPS Actor as an answer to a previously received Payment transaction status query.

References/links

The XSD schema and the related message example can be downloaded from the ECB Website.

Table 95 – ReturnTransaction (camt.006.001.07)

| Field Name | Description | XML path | Mand. | TIPS Usage |
|-----------------------------------|--|---|-------|---|
| Message Identifier | Identification of the message assigned by TIPS | RtrTx/MsgHdr/MsgId | Yes | |
| Original Query Message Identifier | Identification of the originating query message | RtrTx/MsgHdr/OrgnlBizQry/MsgId | Yes | Field is filled with originating Message Identifier. |
| Request Type | Type of the request | RtrTx/MsgHdr/ReqTp/Prtry/Id | Yes | Possible value: - INPA : for Payment transaction status query |
| Originator BIC | Originator of the Instant Payment Transaction | RtrTx/RptOrErr/BizRpt/TxRpt/TxOrErr/Tx/PmtFr/Mmbld/FinInstnId/BICFI | No | |
| Beneficiary BIC | Beneficiary of the Instant Payment Transaction | RtrTx/RptOrErr/BizRpt/TxRpt/TxOrErr/Tx/PmtTo/Mmbld/FinInstnId/BICFI | No | |
| Payment Transaction reference | Identification of the Instant Payment Transaction. | RtrTx/RptOrErr/BizRpt/TxRpt/TxOrErr/Tx/Pmt/TxId | Yes | pacs.008 Transaction Identification or pacs.004 Return Identification |
| Transaction Type | Type of the reported payment | RtrTx/RptOrErr/BizRpt/TxRpt/TxOrErr/Tx/Pmt/Tp/Cd | Yes | Possible value: - EXP : for Instant Payment Transaction |
| Payment transaction amount | Amount of the reported Instant Payment Transaction | RtrTx/RptOrErr/BizRpt/TxRpt/TxOrErr/Tx/Pmt/IntrBkStlImAmt/AmtWthCcy | Yes | |

| Field Name | Description | XML path | Mand. | TIPS Usage |
|-----------------------------------|--|--|-------|--|
| Payment status code | Status of the Instant Payment Transaction and codes of related timestamps. | RtrTx/RptOrErr/BizRpt/TxRpt/TxOrErr/Tx/Pmt/Sts /Cd | Yes | |
| Payment status code + Final | Status of the Instant Payment Transaction | RtrTx/RptOrErr/BizRpt/TxRpt/TxOrErr/Tx/Pmt/Sts /Cd/Fnl | Yes | Used to report the following statuses: - STLD : for Settled; - CAND : for Cancelled; - FNLD : for Expired. |
| Payment status code + RTGS | Status of the Instant Payment Transaction | RtrTx/RptOrErr/BizRpt/TxRpt/TxOrErr/Tx/Pmt/Sts /Cd/RTGS | Yes | Used to report the status: - FAIL : for Failed. |
| Payment status code + Pending | Status of the Instant Payment Transaction | RtrTx/RptOrErr/BizRpt/TxRpt/TxOrErr/Tx/Pmt/Sts /Cd/Pdg | | Used to report the status: - PSTL : for Reserved. |
| Payment status code + Proprietary | Proprietary code of the reported timestamp. | RtrTx/RptOrErr/BizRpt/TxRpt/TxOrErr/Tx/Pmt/Sts /Cd/Prtry | Yes | In combination with the Timestamp field, it identifies the reported timestamps related to the Instant Payment Transaction. Possible values: - ACCP : for acceptance timestamp; - ORCV : for payment transaction reception timestamp (from the originator); - BFWD : for payment transaction forwarding timestamp (to the beneficiary); - BRCV : for confirmation reception timestamp (from the beneficiary); - OFWD : for confirmation to the originator timestamp. |

| Field Name | Description | XML path | Mand. | TIPS Usage |
|------------|--------------------------------------|---|-------|---|
| Timestamp | Timestamp related to the status code | RtrTx/RptOrErr/BizRpt/TxRpt/TxOrErr/Tx/Pmt/Sts/DtTm/DtTm | No | <p>In case the status is STLD, it reports the time at which Instant Payment Transaction was settled.</p> <p>For the Proprietary codes in Sts/Cd/Prtry, it reports the following timestamps:</p> <ul style="list-style-type: none"> - for ACCP: the acceptance timestamp; - for ORCV: the payment transaction reception timestamp (from the originator); - for BFWD: the payment transaction forwarding timestamp (to the beneficiary); - for BRCV: the confirmation reception timestamp (from the beneficiary); - for OFWD: the confirmation to the originator timestamp. <p>It is not reported otherwise</p> |
| Reason | Reason of the unsettled status | RtrTx/RptOrErr/BizRpt/TxRpt/TxOrErr/Tx/Pmt/Sts/Rsn/PrtryRjctn | | Not filled in case the Transaction status is settled |

Table 96 – ReturnTransaction (camt.006.001.07) – error scenario

| Field Name | Description | XML path | Mand. | TIPS Usage |
|-----------------------------------|---|--------------------------------|-------|--|
| Message Identifier | Identification of the message assigned by TIPS | RtrTx/MsgHdr/MsgId | Yes | |
| Original Query Message Identifier | Identification of the originating query message | RtrTx/MsgHdr/OrgnlBizQry/MsgId | Yes | Field is filled with originating Message Identifier. |
| Request Type | Type of the request | RtrTx/MsgHdr/ReqTp/Prtry/Id | Yes | <p>Possible value:</p> <ul style="list-style-type: none"> - INPA: for Payment transaction status query |

| Field Name | Description | XML path | Mand. | TIPS Usage |
|-------------------|--|-------------------------------|-------|------------|
| Operational Error | Specifies the error occurred when processing the originating query message | RtrTx/RptOrErr/OprlErr/Err/Cd | Yes | |

3.3.2.2.5 ModifyLimit (camt.011.001.07)

The ModifyLimit message is used in TIPS to manage the limit definition for CMBs.

It is sent by a TIPS Participant, Ancillary System or authorised Instructing Party to request an immediate change to the allowed Limit on a specific account for a CMB user.

References/links

The schema and the related documentation in XSD/EXCEL/PDF format as well as the message examples are provided within the MyStandards repository under the following link:

<https://www.swift.com/mystandards/TIPS/camt.011.001.07>

Table 97 – ModifyLimit (camt.011.001.07)

| Field Name | Description | XML path | Mand. | TIPS Usage |
|------------------------|--|---|-------|---|
| Message Identifier | Identification of the message | ModifyLmt/MsgHdr/MsgId | Yes | Field is referenced in the resulting camt.025 message |
| Creation Date Time | Timestamp assigned when message has been generated | ModifyLmt/MsgHdr/CreDtTm | Yes | Only schema validation is performed. |
| CMB User BIC | BIC of the CMB user | ModifyLmt/LmtDtls/LmtId/Cur/BilLmtCtrPtyId/FinInstnId/BICFI | Yes | Field is used to retrieve the unique CMB defined for the BIC |
| Limit Type | Type of the limit to be modified | ModifyLmt/LmtDtls/LmtId/Cur/Tp/Cd | Yes | Only allowed value is INBI . Possible values are checked within schema validation. |
| Account Owner | BIC of the requestor party | ModifyLmt/LmtDtls/LmtId/Cur/AcctOwnr/FinInstnId/BICFI | Yes | Field is used in combination with the requestor DN to perform the access rights check |
| Account Identification | Identification of the account linked to the referenced CMB | ModifyLmt/LmtDtls/LmtId/Cur/AcctId/Othr/Id | Yes | Field is used to identify the limit |
| New Limit Value | New limit to be applied to the CMB | ModifyLmt/LmtDtls/NewLmtValSet/Amt/AmtWthCc y | Yes | Possible values are checked within schema validation. |

3.3.2.2.6 ReturnBusinessDayInformation (camt.019.001.07)

The ReturnBusinessDayInformation message is sent by the RTGS system to TIPS to:

- Notify the change of RTGS Business Date;
- Notify the partial closure for inter-service liquidity transfers;
- Trigger the generation of the snapshot containing all the TIPS accounts balances in a given currency;
- Enable or disable the acceptance of outbound liquidity transfers instructed to TIPS.

References/links

The schema and the related documentation in XSD/EXCEL/PDF format as well as the message examples are provided within the MyStandards repository under the following link:

- <https://www.swift.com/mystandards/TIPS/camt.019.001.07>

Table 98 – ReturnBusinessDayInformation (camt.019.001.07)

| Field Name | Description | XML path | Mand. | TIPS Usage |
|--------------------------------------|---|--|-------|--|
| Message Identifier | Identification of the message. | RtrBizDayInf/MsgHdr/MsgId | Yes | Identifier which will be referenced in the Receipt. |
| Creation Date Time | Timestamp assigned when message has been generated. | RtrBizDayInf/MsgHdr/CreDtTm | Yes | Only schema validation is performed. |
| Market Infrastructure Identification | Identification code of the Market Infrastructure. | RtrBizDayInf/RptOrErr/BizRpt/SysId/MktInfrstrctrl d/Cd | Yes | Only schema validation is performed. |
| System Date | Business date of the RTGS System. | RtrBizDayInf/RptOrErr/BizRpt/BizDayOrErr/BizDayInf/SysDt | Yes | In case the message is sent for the change of business date, this field contains the next RTGS business date. |
| System Status | Status of the RTGS System | RtrBizDayInf/RptOrErr/BizRpt/BizDayOrErr/BizDayInf/SysSts/Sts/Prtry/Id | Yes | Status change of the RTGS System. Possible values: - CHBD : for Change Business Date; - STRT : for Start Inbound/Outbound Liquidity Transfers; - STOP : for Stop Inbound/Outbound Liquidity Transfers; - SNAP : for taking the snapshot of the accounts denominated in the field RTGS interested currency; - STCB : for preventing any Outbound Liquidity |

| Field Name | Description | XML path | Mand. | TIPS Usage |
|-----------------|--------------------------|--|-------|--|
| | | | | Transfer denominated in the field RTGS interested currency from a non-Central Bank user. |
| System Currency | RTGS interested currency | RtrBizDayInf/RptOrErr/BizRpt/BizDayOrErr/BizDayInf/SysInfPerCcy/SysCcy | Yes | Currency for which the RTGS status is changed. |

3.3.2.2.7 Receipt (camt.025.001.05)

The Receipt (camt.025.001.05) message is used in TIPS in different business cases related to Liquidity Credit Transfer area (for the interaction with the customer) and CMB limit modification.

The Receipt message is then sent to the Originator of the Liquidity Transfer.

In the intra-service Liquidity Transfer scenario, it is sent by TIPS to the sender to report about the execution of the liquidity transfer.

In the CMB Limit modification context, it is sent by TIPS to the interested TIPS Participant, Ancillary System or Instructing Party originating the Modify Limit message.

References/links

The schema and the related documentation in XSD/EXCEL/PDF format as well as the message examples are provided within the MyStandards repository under the following link:

<https://www.swift.com/mystandards/TIPS/camt.025.001.05>

Table 99 – Receipt (camt.025.001.05)

| Field Name | Description | XML path | Mand. | TIPS Usage |
|---------------------------------|--|------------------------------|-------|--|
| Message Identifier | Identification of the message | Rct/MsgHdr/Msgld | Yes | Only schema validation is performed. |
| Creation Date Time | Timestamp of the creation of the message | Rct/MsgHdr/CreDtTm | No | Timestamp when the request has been processed. |
| Original Message Identification | Identification of the originating liquidity credit transfer or limit modification request | Rct/RctDtls/OrgnlMsgld/Msgld | Yes | |
| Status Code | Specifies the status of the originating liquidity credit transfer or limit modification request | Rct/RctDtls/ReqHdlg/StsCd | Yes | |
| Status Description | Additional information on the reported status of the originating liquidity credit transfer or limit modification request | Rct/RctDtls/ReqHdlg/Desc | No | It must be filled whenever an error occurs |

3.3.2.2.8 Receipt (camt.025.001.04)

The Receipt message (camt.025.001.04) is used in TIPS in the interaction with the RTGS Systems for the Liquidity Credit Transfer scenarios and for the change of business date of the RTGS System scenario.

In the Inbound Liquidity Transfer scenario, it is sent by TIPS to the RTGS System to report about the execution of the liquidity transfer.

In the Outbound liquidity transfer, it is sent by the RTGS System to TIPS to report about the execution of the liquidity transfer.

In the Outbound liquidity transfer - pull request scenario, it is sent by the RTGS System to TIPS to report about the execution of the liquidity transfer and then it is forwarded by TIPS to the RTGS System.

In the RTGS System change of business date and Snapshot⁶⁰ message scenarios, it is used by TIPS to inform the RTGS System that TIPS received the confirmation of settlement or the rejection for all the transient Liquidity Transfers.

References/links

The schema and the related documentation in XSD/EXCEL/PDF format as well as the message examples are provided within the MyStandards repository under the following link:

<https://www.swift.com/mystandards/TIPS/camt.025.001.04>

Table 100 – Receipt (camt.025.001.04)

| Field Name | Description | XML path | Mand. | TIPS Usage |
|----------------------------|--|--------------------------------------|-------|--|
| Message Identifier | Identification of the message | Rct/MsgHdr/MsgId | Yes | Only schema validation is performed. |
| Transaction Identification | Identification of the originating Liquidity Transfer | Rct/RctDtls/OrgnPmtId/ShrtBizId/TxId | No | For camt.025 sent by RTGS to TIPS, it must be filled with the Instruction Identification of the originating Liquidity Transfer. It is not filled in camt.025 generated by TIPS. |

⁶⁰ The snapshot message is optional and configured on the basis of the business requirements. For the time being, only snapshot for DKK accounts is envisaged.

| Field Name | Description | XML path | Mand. | TIPS Usage |
|---------------------------------|--|---|-------|--|
| Interbank Settlement Date | Settlement Date of the originating Liquidity Transfer | Rct/RctDtls/OrgnPmtId/ShrtBizId/IntrBkStlmDt | No | For camt.025 sent by an RTGS System to TIPS, it must be filled with the Settlement Date of the originating Liquidity Transfer. It is not filled in camt.025 generated by TIPS. |
| Instructing Agent | Debtor of the originating Liquidity Transfer | Rct/RctDtls/OrgnPmtId/ShrtBizId/InstgAgt/FinInstnId/BICFI | No | For camt.025 sent by an RTGS System to TIPS, it must be filled with the Debtor BIC of the originating Liquidity Transfer. It is not filled in camt.025 generated by TIPS. |
| Creation Date Time | Timestamp of the creation of the message | Rct/MsgHdr/CreDtTm | No | Timestamp when the request has been processed. |
| Original Message Identification | Identification of the originating liquidity credit transfer | Rct/RctDtls/OrgnMsgld/Msgld | Yes | |
| Status Code | Specifies the status of the originating liquidity credit transfer | Rct/RctDtls/ReqHdlg/StsCd | Yes | Possible status codes: - RREJ : for rejection; - RCON : for confirmation; - CMPT : for completed. The latter status is sent by TIPS to the RTGS System to inform that all transient LT have been processed. |
| Status Description | Additional information on the reported status of the originating liquidity credit transfer | Rct/RctDtls/ReqHdlg/Desc | No | It must be filled whenever an error occurs |

3.3.2.2.9 ResolutionOfInvestigation (camt.029.001.09)

The Resolution of Investigation message is sent by the Assignee party of a [FIToFIPaymentCancellationRequest](#) (Recall), triggered by an Assigner party for a formerly settled Instant Payment transaction, as a negative response. The Recall's Assignee party becomes the Assigner party of the negative response.

Additionally, the ResolutionOfInvestigation message can be sent in reply to a Request for Status Update on a Recall.

Message specification is compliant to EPC DS-06 Inter-PSP Payment Dataset as described in the SEPA Instant Credit Transfer scheme Rulebook.

TIPS receives this message by the Assignee party, checks the related access rights and the reachability of the Assigner party.

No further processing but message schema validation is performed as the message is directly forwarded to the party which formerly triggered the Recall process.

References/links

The schema and the related documentation in XSD/EXCEL/PDF format as well as the message examples are provided within the MyStandards repository under the following link:

<https://www.swift.com/mystandards/TIPS/camt.029.001.09>

Table 101 – ResolutionOfInvestigation (camt.029.001.09)

| EPC Ref. | Reference Name | EPC Description | XML path | Mand. | TIPS Usage |
|----------|--------------------------------------|--|--|-------|---|
| n/a | Assignment + Identification | Uniquely identifies the case assignment. | RsltnOfInvstgtn/Assgnmt/Id | Yes | Only schema validation is performed. |
| n/a | Assigner | Party who sends the Resolution of Investigation message. | RsltnOfInvstgtn/Assgnmt/Assgnr/Agt/FinInstnl d/BICFI | Yes | This field must be filled with the BIC of the party sending the Resolution of Investigation message and is used in combination with the requestor Distinguished Name to check user access rights. |
| n/a | Assignee | Party to which the case is assigned | RsltnOfInvstgtn/Assgnmt/Assgne/Agt/FinInstnl d/BICFI | Yes | This field must be filled with the BIC of the party to which the Resolution of Investigation message is forwarded. |
| n/a | Assignment + Creation Date Time | Date and time at which the assignment was created. | RsltnOfInvstgtn/Assgnmt/CreDtTm | Yes | Only schema validation is performed. |
| n/a | Status + Confirmation | Specifies the status of the investigation, in a coded form. | RsltnOfInvstgtn/Sts/Conf | Yes | Possible values are checked within schema validation. |
| n/a | Cancellation Status Identification | Unique and unambiguous identifier of a cancellation request status, as assigned by the assigner. | RsltnOfInvstgtn/CxlDtIs/TxInfAndSts/CxlStsId | Yes | Only schema validation is performed. |
| n/a | Original Message Identification | Message Identification of the originating message | RsltnOfInvstgtn/CxlDtIs/TxInfAndSts/OrgnlGrplnf/OrgnlMsgld | Yes | Only schema validation is performed. |
| n/a | Original Message Name Identification | Message identifier of the originating message | RsltnOfInvstgtn/CxlDtIs/TxInfAndSts/OrgnlGrplnf/OrgnlMsgNmld | Yes | Possible allowed values ⁶¹ : "pacs.008.001.08" or "pacs.008.001.02" |
| n/a | Original Instruction Identification | Unique identification, as assigned by the original instructing party for the original instructed party | RsltnOfInvstgtn/CxlDtIs/TxInfAndSts/OrgnlInstrld | No | Only schema validation is performed. |

⁶¹ The usage of the correct Original Message Name Identification, in relation to the moment in which the original message was sent in reference to the migration date to the 2019 message version of ISO 20022, should be ensured by the actor who generates and sends the message to TIPS: no check on the correspondence of this value with respect to the version of the original message is performed by TIPS.

| EPC Ref. | Reference Name | EPC Description | XML path | Mand. | TIPS Usage |
|---|---|--|---|-------|---|
| AT-T014 | Original End To End Identification | The Originator's reference of the SCT ^{Inst} Transaction | RsltnOfInvstgtn/CxlDtIs/TxInfAndSts/OrgnlEndT oEndId | Yes | Only schema validation is performed. |
| AT-T054 | Original Transaction Identification | The Originator PSP's reference number of the SCT ^{Inst} Transaction message | RsltnOfInvstgtn/CxlDtIs/TxInfAndSts/OrgnlTxId | Yes | Only schema validation is performed. |
| n/a | Transaction Cancellation Status | Specifies the status of the transaction cancellation request. | RsltnOfInvstgtn/CxlDtIs/TxInfAndSts/TxCxlSts | Yes | Possible values are checked within schema validation. |
| n/a | Cancellation Status Reason Information | Set of elements used to provide detailed information on the cancellation status reason. | RsltnOfInvstgtn/CxlDtIs/TxInfAndSts/CxlStsRsn Inf | Yes | Only schema validation is performed. |
| AT-E001/ AT-C002 | Cancellation Status Reason Information + Originator | The Name of the Beneficiary or the BIC code of the Beneficiary PSP | RsltnOfInvstgtn/CxlDtIs/TxInfAndSts/CxlStsRsn Inf/Orgtr | Yes | Only schema validation is performed. |
| AT-R057 | Cancellation Status Reason Information + Reason | The Reason Code for non-acceptance of the Recall. | RsltnOfInvstgtn/CxlDtIs/TxInfAndSts/CxlStsRsn Inf/Rsn | Yes | Only schema validation is performed. |
| n/a | Cancellation Status Reason Information + Reason ++ Code | Reason for the cancellation status, in a coded form. | RsltnOfInvstgtn/CxlDtIs/TxInfAndSts/CxlStsRsn Inf/Rsn/Cd | Yes | Only schema validation is performed. |
| n/a | Cancellation Status Reason Information + Reason ++ Proprietary | Reason for the status, in a proprietary form. | RsltnOfInvstgtn/CxlDtIs/TxInfAndSts/CxlStsRsn Inf/Rsn/Prtry | Yes | Only schema validation is performed. |
| AT-R053 AT-R057 / AT-R072 AT-R078 | Cancellation Status Reason Information + Additional Information | Further details on the cancellation status reason. | RsltnOfInvstgtn/CxlDtIs/TxInfAndSts/CxlStsRsn Inf/AddtlInf | Yes | Only schema validation is performed. |
| n/a | Original Transaction Reference | Set of key elements used to identify the original transaction that is being referred to. | RsltnOfInvstgtn/CxlDtIs/TxInfAndSts/OrgnlTxRef | Yes | Only schema validation is performed. |
| AT-T002 | Interbank Settlement Amount | The amount of the SCT ^{Inst} in euro. | RsltnOfInvstgtn/CxlDtIs/TxInfAndSts/OrgnlTxRef/IntrBkSttlmAmt | No | Only schema validation is performed. |
| AT-T051 | Interbank Settlement Date | The Settlement Date of the SCT ^{Inst} Transaction. | RsltnOfInvstgtn/CxlDtIs/TxInfAndSts/OrgnlTxRef/IntrBkSttlmDt | No | Only schema validation is performed. |
| AT-T001 | Scheme Identification Code | The identification code of the SCT ^{Inst} Scheme | RsltnOfInvstgtn/CxlDtIs/TxInfAndSts/OrgnlTxRef/PmtTPlnf/SvcLvl/Cd RsltnOfInvstgtn/CxlDtIs/TxInfAndSts/OrgnlTxRef/PmtTPlnf/LclInstrm/Cd | No | Possible values are checked within schema validation. |
| AT-T008 | Category Purpose | The category purpose of the SCT ^{Inst} Instruction | RsltnOfInvstgtn/CxlDtIs/TxInfAndSts/OrgnlTxRef/PmtTPlnf/CtgyPurp | No | Only schema validation is performed. |
| AT-T009 | Remittance Information | Information supplied to enable the matching of an entry with the items that the transfer is intended to settle | RsltnOfInvstgtn/CxlDtIs/TxInfAndSts/OrgnlTxRef/RmtInf | No | Only schema validation is performed. |
| AT-P006 | Ultimate Debtor + Name | The name of the Originator Reference Party. | RsltnOfInvstgtn/CxlDtIs/TxInfAndSts/OrgnlTxRef/UltmtDbtr/Pty/Nm | No | Only schema validation is performed. |
| AT-P007 | Ultimate Debtor + Identification | The identification code of the Originator Reference Party. | RsltnOfInvstgtn/CxlDtIs/TxInfAndSts/OrgnlTxRef/UltmtDbtr/Pty/Id | No | Only schema validation is performed. |
| AT-P001 | Debtor + Name | The name of the Originator. | RsltnOfInvstgtn/CxlDtIs/TxInfAndSts/OrgnlTxRef/Dbtr/Pty/Nm | No | Only schema validation is performed. |

| EPC Ref. | Reference Name | EPC Description | XML path | Mand. | TIPS Usage |
|----------|------------------------------------|--|---|-------|--------------------------------------|
| AT-P005 | Debtor + Postal Address | The address of the Originator. | RsltnOfInvstgtn/CxlDtIs/TxInfAndSts/OrgnlTxRef/Dbtr/Pty/PstlAdr | No | Only schema validation is performed. |
| AT-P004 | Debtor + Identification | The Originator identification code. | RsltnOfInvstgtn/CxlDtIs/TxInfAndSts/OrgnlTxRef/Dbtr/Pty/Id | No | Only schema validation is performed. |
| AT-D001 | Debtor Account | The IBAN of the account of the Originator. | RsltnOfInvstgtn/CxlDtIs/TxInfAndSts/OrgnlTxRef/DbtrAcct/Id/IBAN | Yes | Only schema validation is performed. |
| AT-P003 | Proxy | Specifies an alternate assumed name for the identification of the account. | RsltnOfInvstgtn/CxlDtIs/TxInfAndSts/OrgnlTxRef/DbtrAcct/Prxy | No | Only schema validation is performed. |
| AT-D002 | Debtor Agent | The BIC code of the Originator PSP. | RsltnOfInvstgtn/CxlDtIs/TxInfAndSts/OrgnlTxRef/DbtrAgt | No | Only schema validation is performed. |
| AT-C002 | Creditor Agent | The BIC code of the Beneficiary PSP. | RsltnOfInvstgtn/CxlDtIs/TxInfAndSts/OrgnlTxRef/CdtrAgt | No | Only schema validation is performed. |
| AT-E001 | Creditor + Name | The name of the Beneficiary. | RsltnOfInvstgtn/CxlDtIs/TxInfAndSts/OrgnlTxRef/Cdtr/Pty/Nm | No | Only schema validation is performed. |
| AT-E004 | Creditor + Postal Address | The address of the Beneficiary. | RsltnOfInvstgtn/CxlDtIs/TxInfAndSts/OrgnlTxRef/Cdtr/Pty/PstlAdr | No | Only schema validation is performed. |
| AT-E005 | Creditor + Identification | The Beneficiary identification code. | RsltnOfInvstgtn/CxlDtIs/TxInfAndSts/OrgnlTxRef/Cdtr/Pty/Id | No | Only schema validation is performed. |
| AT-C001 | Creditor Account | The IBAN of the account of the Beneficiary. | RsltnOfInvstgtn/CxlDtIs/TxInfAndSts/OrgnlTxRef/CdtrAcct/Id/IBAN | Yes | Only schema validation is performed. |
| AT-E003 | Proxy | Specifies an alternate assumed name for the identification of the account. | RsltnOfInvstgtn/CxlDtIs/TxInfAndSts/OrgnlTxRef/CdtrAcct/Prxy | No | Only schema validation is performed. |
| AT-E007 | Ultimate Creditor + Name | Name of the Beneficiary Reference Party. | RsltnOfInvstgtn/CxlDtIs/TxInfAndSts/OrgnlTxRef/UltmtCdtr/Pty/Nm | No | Only schema validation is performed. |
| AT-E010 | Ultimate Creditor + Identification | Identification code of the Beneficiary Reference Party. | RsltnOfInvstgtn/CxlDtIs/TxInfAndSts/OrgnlTxRef/UltmtCdtr/Pty/Id | No | Only schema validation is performed. |
| AT-T007 | Purpose | Underlying reason for the payment transaction. | RsltnOfInvstgtn/CxlDtIs/TxInfAndSts/OrgnlTxRef/Purp | No | Only schema validation is performed. |

3.3.2.2.10 LiquidityCreditTransfer (camt.050.001.05)

The Liquidity Credit Transfer message is used in TIPS in order to instruct inbound and outbound liquidity transfers to/from RTGS Systems to fund accounts of TIPS Participants or repatriate money in the related RTGS System.

Authorised technical user (RTGS System) can send inbound liquidity transfers from the corresponding RTGS to TIPS. In case the validation is successful TIPS transfers the requested amount from the (technical) transit account to the TIPS Account.

TIPS Participants or Instructing Parties can trigger outbound liquidity transfers in TIPS using a liquidity transfer order message.

Additionally, the message is used to instruct intra-service Liquidity Transfers to fund/defund TIPS AS Technical Account.

TIPS Participants or Instructing Parties can trigger intra-service liquidity transfers to fund a TIPS AS Technical Account. If the Ancillary System owning the TIPS AS Technical Account to be funded has been set up as Instructing Party of the TIPS Participant, it can trigger the liquidity transfer on behalf of the TIPS Participant, provided it has been granted the necessary privileges.

Ancillary systems can trigger intra-service liquidity transfers to defund their TIPS AS Technical Account.

References/links

The schema and the related documentation in XSD/EXCEL/PDF format as well as the message examples are provided within the MyStandards repository under the following link:

<https://www.swift.com/mystandards/TIPS/camt.050.001.05>

Table 102 – Outbound and intra-service LiquidityCreditTransfer (camt.050.001.05)

| Field Name | Description | XML path | Mand. | TIPS Usage |
|----------------------------|---|---|-------|---|
| Message Identifier | Identification of the message | LqdyCdtTrf/MsgHdr/MsgId | Yes | |
| Instruction Identification | Identification of the requested credit transfer | LqdyCdtTrf/LqdyCdtTrf/LqdyTrfId/InstrId | Yes | |
| End to End Identification | End to end identifier for the requested credit transfer | LqdyCdtTrf/LqdyCdtTrf/LqdyTrfId/EndToEndId | Yes | If not used, it must be filled with NOTPROVIDED |
| Creditor | BIC of Financial Institution owning the account to be credited or the BIC of the Financial Institution on whose behalf the Liquidity Transfer is performed (only in case of intra-service liquidity transfers funding a TIPS AS technical account). | LqdyCdtTrf/LqdyCdtTrf/Cdtr/FinInstnId/BICFI | No | This field must be included in outbound liquidity transfers. The field is optional in intra-service liquidity transfers. |
| Creditor Account | Account to be credited | LqdyCdtTrf/LqdyCdtTrf/CdtrAcct/Id/Othr/Id | Yes | |
| Creditor Account Type | Type of the account to be credited | LqdyCdtTrf/LqdyCdtTrf/CdtrAcct/Tp | No | This field must not be included in the request. The message will be rejected in that case. |
| Transferred Amount | Amount to be transferred from the debited account to the credited account | LqdyCdtTrf/LqdyCdtTrf/TrfdAmt/AmtWthCcy | Yes | |
| Debtor | BIC of Financial Institution owning the account to be debited | LqdyCdtTrf/LqdyCdtTrf/Dbtr/FinInstnId/BICFI | Yes | |
| Debtor Account | Account to be debited | LqdyCdtTrf/LqdyCdtTrf/DbtrAcct/Id/Othr/Id | Yes | |
| Debtor Account Type | Type of the account to be debited | LqdyCdtTrf/LqdyCdtTrf/DbtrAcct/Tp | No | This field must not be included in the request. |

| Field Name | Description | XML path | Mand. | TIPS Usage |
|-----------------|--|-------------------------------|-------|--|
| | | | | The message will be rejected in that case. |
| Settlement Date | Settlement date of the Credit Transfer | LqdyCdtTrf/LqdyCdtTrf/SttlmDt | No | This must be included in outgoing Credit Transfer. It must be filled with the stored RTGS business date. |

Table 103 – Inbound and Outbound Pull LiquidityCreditTransfer (camt.050.001.05) – RTGS interaction scenarios

| Field Name | Description | XML path | Mand. | TIPS Usage |
|----------------------------|---|---|-------|--|
| Message Identifier | Identification of the message | LqdyCdtTrf/MsgHdr/MsgId | Yes | |
| Instruction Identification | Identification of the requested credit transfer | LqdyCdtTrf/LqdyCdtTrf/LqdyTrfId/InstrId | Yes | |
| End to End Identification | End to end identifier for the requested credit transfer | LqdyCdtTrf/LqdyCdtTrf/LqdyTrfId/EndToEndId | Yes | If not used, it must be filled with NOTPROVIDED |
| Creditor | BIC of Financial Institution owning the account to be credited | LqdyCdtTrf/LqdyCdtTrf/Cdtr/FinInstnId/BICFI | No | This field must be included in outbound liquidity transfers pull. |
| Creditor Account | Account to be credited | LqdyCdtTrf/LqdyCdtTrf/CdtrAcct/Id/Othr/Id | Yes | |
| Creditor Account Type | Type of the account to be credited | LqdyCdtTrf/LqdyCdtTrf/CdtrAcct/Tp | No | This field must be filled with the following values: - SACC : for Outbound Liquidity Transfer Pull Request; - CASH : for Inbound Liquidity Transfer |
| Transferred Amount | Amount to be transferred from the debited account to the credited account | LqdyCdtTrf/LqdyCdtTrf/TrfdAmt/AmtWthCcy | Yes | |
| Debtor | BIC of Financial Institution owning the account to be debited | LqdyCdtTrf/LqdyCdtTrf/Dbtr/FinInstnId/BICFI | Yes | |
| Debtor Account | Account to be debited | LqdyCdtTrf/LqdyCdtTrf/DbtrAcct/Id/Othr/Id | Yes | |
| Debtor Account Type | Type of the account to be debited | LqdyCdtTrf/LqdyCdtTrf/DbtrAcct/Tp | No | This field must be filled with the following values: - CASH : for Outbound Liquidity Transfer Pull Request; - SACC : for Inbound Liquidity Transfer. |
| Settlement Date | Settlement date of the Credit Transfer | LqdyCdtTrf/LqdyCdtTrf/SttlmDt | No | This must be included in Outbound Liquidity |

| Field Name | Description | XML path | Mand. | TIPS Usage |
|------------|-------------|----------|-------|---|
| | | | | Transfer Pull Request. It must be filled with the RTGS business date. |

3.3.2.2.11 BankToCustomerAccountReport (camt.052.001.06)

The Bank To Customer Account Report is used in TIPS to provide information regarding all the accounts in the data scope of the TIPS actor.

References/links

The schema and the related documentation in XSD/EXCEL/PDF format as well as the message examples are provided within the MyStandards repository under the following link:

<https://www.swift.com/mystandards/TIPS/camt.052.001.06>

Table 104 – BankToCustomerAccountReport (camt.052.001.06)

| Field Name | Description | XML path | Mand. | TIPS Usage |
|------------------------|---|--|-------|--|
| Message Identifier | Identification of the message | BkToCstmrAcctRpt/GrpHdr/MsgId | Yes | |
| Creation Date Time | Timestamp of the creation of the message | BkToCstmrAcctRpt/GrpHdr/CreDtTm | Yes | |
| Report Identifier | Unique identification, as assigned by TIPS , to unambiguously identify each report: contains Sequential Number of the report. | BkToCstmrAcctRpt/Rpt/Id | Yes | |
| Creation Date Time | Timestamp of the creation of the report | BkToCstmrAcctRpt/Rpt/CreDtTm | Yes | Must be equal to the Creation Date Time of the message |
| Account Identification | Account reported | BkToCstmrAcctRpt/Rpt/Acct/Id/Othr/Id | Yes | |
| Account Currency | Currency of the Account | BkToCstmrAcctRpt/Rpt/Acct/Ccy | Yes | |
| Account Owner | BIC of Financial Institution owning the account reported | BkToCstmrAcctRpt/Rpt/Acct/Ownr/Id/OrgId/AnyBIC | Yes | |
| Balance | Set of elements to define the balance. | BkToCstmrAcctRpt/Rpt/Bal | Yes | For every Report of the statement, two Balance blocks are included. These blocks provide with the Opening and Closing Balance for the reported Account. |

| Field Name | Description | XML path | Mand. | TIPS Usage |
|------------------------|---|---|-------|---|
| Balance Type | Type of the balance reported | BkToCstmrAcctRpt/Rpt/Bal/Tp/CdOrPrtry/Prtry | Yes | Allowed values: - OPBD : Opening balance at start of RTGS business day; - CLBD : Closing balance at end of RTGS business day. |
| Amount | Balance Amount with currency | BkToCstmrAcctRpt/Rpt/Bal/Amt | Yes | |
| Credit/debit Indicator | Specifies if the Amount is credited or debited | BkToCstmrAcctRpt/Rpt/Bal/CdtDbtInd | Yes | |
| RTGS business date | RTGS business date for which the information is retrieved; | BkToCstmrAcctRpt/Rpt/Bal/Dt | Yes | It must be filled with the stored RTGS business date. |
| Sum of credits | Sum of the credits occurred on the Account for the pre-agreed account reporting period. | BkToCstmrAcctRpt/Rpt/TxsSummry/TtlCdtNtries/Sum | Yes | |
| Sum of debits | Sum of the debits occurred on the Account for the pre-agreed account reporting period. | BkToCstmrAcctRpt/Rpt/TxsSummry/TtlDbtNtries/Sum | Yes | |

3.3.2.2.12 BankToCustomerStatement (camt.053.001.06)

The Bank To Customer Statement (camt.053.001.06) provides detailed information on the activities recorded for all the accounts in the data scope of the recipient actor.

References/links

The schema and the related documentation in XSD/EXCEL/PDF format as well as the message examples are provided within the MyStandards repository under the following link:

<https://www.swift.com/mystandards/TIPS/camt.053.001.06>

Table 105 – BankToCustomerStatement (camt.053.001.06)

| Field Name | Description | XML path | Mand. | TIPS Usage |
|----------------------|---|------------------------------|-------|------------|
| Message Identifier | Identification of the message | BkToCstmrStmt/GrpHdr/MsgId | Yes | |
| Creation Date Time | Timestamp of the creation of the message | BkToCstmrStmt/GrpHdr/CreDtTm | Yes | |
| Statement Identifier | Sequential number, as assigned by TIPS, to unambiguously identify each reported Account in the statement. | BkToCstmrStmt/Stmt/Id | Yes | |

| Field Name | Description | XML path | Mand. | TIPS Usage |
|------------------------------------|---|--|-------|---|
| Creation Date Time | Timestamp of the creation of the statement | BkToCstmrStmt/Stmt/CreDtTm | Yes | Must be equal to the Creation Date Time of the message |
| Start Timestamp | Start Timestamp for which the account statement is issued | BkToCstmrStmt/Stmt/FrToDt/FrDtTm | No | Filled only for delta statement |
| End Timestamp | End Timestamp for which the account statement is issued | BkToCstmrStmt/Stmt/FrToDt/ToDtTm | No | Filled only for delta statement |
| Account Identification | Account reported | BkToCstmrStmt/Stmt/Acct/Id | Yes | |
| Account Currency | Currency of the Account | BkToCstmrStmt/Stmt/Acct/Ccy | Yes | |
| Account Owner | BIC of Financial Institution owning the account reported | BkToCstmrStmt/Stmt/Acct/Ownr/Id/OrgId/AnyBIC | Yes | |
| Balance Type | Type of the balance reported | BkToCstmrStmt/Stmt/Bal/Tp/CdOrPrtry/Cd | Yes | Allowed value: - CLBD : Balance of the account at the end of the pre-agreed account reporting period. |
| Amount | Balance Amount with currency | BkToCstmrStmt/Stmt/Bal/Amt | Yes | |
| Credit/debit Indicator | Specifies if the Account balance is positive or negative | BkToCstmrStmt/Stmt/Bal/CdtDbtInd | Yes | |
| RTGS business date | RTGS business date for which the information is retrieved | BkToCstmrStmt/Stmt/Bal/Dt | Yes | It must be filled with the stored RTGS business date. |
| Entry | Entries of the statement | BkToCstmrStmt/Stmt/Ntry | No | Every Entry block contains the details of an Instant Payment Transaction or Liquidity Transfer which resulted in a movement for the reported account. If no activity occurred for the reported account during the pre-agreed account reporting period, no Entry blocks will be returned. |
| Transaction Reference | Payment transaction or Liquidity transfer reference | BkToCstmrStmt/Stmt/Ntry/NtryRef | Yes | This the Transaction Identification of the reported Instant Payment Transaction or Liquidity Transfer. |
| Transaction Amount | Transaction Amount with currency | BkToCstmrStmt/Stmt/Ntry/Amt | Yes | |
| Transaction Credit/debit Indicator | Specifies if the transaction Amount is credited or debited on the account | BkToCstmrStmt/Stmt/Ntry/CdtDbtInd | Yes | |
| Transaction Status | Specifies the status of the transaction | BkToCstmrStmt/Stmt/Ntry/Sts | Yes | Only BOOK is allowed as only settled transactions are reported. |
| Settlement timestamp | Settlement timestamp of the transaction | BkToCstmrStmt/Stmt/Ntry/BookgDt/DtTm | Yes | |

| Field Name | Description | XML path | Mand. | TIPS Usage |
|------------------------------------|---|--|-------|---|
| Bank transaction code | Bank transaction code of the transaction, which allows to distinguish between Payment Transactions and Liquidity transfer Orders. | BkToCstmrStmnt/Stmnt/Ntry/BkTxCd/Domn/Cd | Yes | Used codes are based on the ExternalBankTransactionDomain ISO documentation. The Domain code allowed value is: - PMNT (Payments). |
| Bank Transaction Code Family | Family of the Bank Transaction Code. | BkToCstmrStmnt/Stmnt/Ntry/BkTxCd/Domn/Fmly/Cd | Yes | Allowed values depend on the type of reported payment: - ICDT : Debited Liquidity Transfers (for Outbound and intra-service LTs ⁶²) - RCDT : Credited Liquidity Transfers (for Inbound and intra-service LTs ⁶³) - IRCT : Debited Instant Payment Transaction - RRCT : Credited Instant Payment Transaction |
| Bank Transaction Code SubFamily | SubFamily of the Bank Transaction Code. | BkToCstmrStmnt/Stmnt/Ntry/BkTxCd/Domn/Fmly/SubFmlyCd | Yes | In terms of reporting, both Instant Payment Transactions and Liquidity Transfers, are defined as Financial Institution Credit Transfer. The allowed value for this field is FICT . |
| Amount Details + ProprietaryAmount | Additional information for Account balance | BkToCstmrStmnt/Stmnt/Ntry/AmtDtls/PrtryAmt | Yes | For every Entry of the statement, two Proprietary Amount blocks are included. These blocks define the Account Balance before and after the settlement of the Instant Payment Transaction or Liquidity Transfers occurred. |
| Transaction Account Balance | Balance of the Account before/after the execution of the transaction | BkToCstmrStmnt/Stmnt/Ntry/AmtDtls/PrtryAmt/Amt | Yes | Amount of the Account Balance for the related Entry. |

⁶² Intra-service LT where the debited account is a TIPS DCA and the credited account is a TIPS AS Technical Account.

⁶³ Intra-service LT where the credited account is a TIPS DCA and the debited account is a TIPS AS Technical Account.

| Field Name | Description | XML path | Mand. | TIPS Usage |
|------------------------------------|---|---|-------|---|
| Transaction Account balance type | Type of the balance | BkToCstmrStmt/Stmt/Ntry/AmtDtls/PrtryAmt/Tp | Yes | Definition of the type of returned Proprietary Amount. Allowed values: - BFTS : Before the settlement of the Transaction; - FTTS : After the settlement of the Transaction. |
| Transaction Amount | Transaction Amount with currency | BkToCstmrStmt/Stmt/Ntry/NtryDtls/TxDtls/Amt | Yes | Same value of the field BkToCstmrStmt/Stmt/Ntry/Amt |
| Transaction Credit/debit Indicator | Specifies if the transaction Amount is credited or debited on the account | BkToCstmrStmt/Stmt/Ntry/NtryDtls/TxDtls/CdtDbtInd | Yes | Same value of the field BkToCstmrStmt/Stmt/Ntry/CdtDbtInd |
| Transaction Originator BIC | BIC of the Originator Participant of the transaction | BkToCstmrStmt/Stmt/Ntry/NtryDtls/TxDtls/RltdAgts/DbtrAgt/FinInstnId/BICFI | Yes | It contains: - The Originator BIC in case of an Instant Payment Transaction; - The Debtor BIC in case of a Liquidity Transfer Order |
| Transaction Beneficiary BIC | BIC of the Beneficiary Participant of the transaction | BkToCstmrStmt/Stmt/Ntry/NtryDtls/TxDtls/RltdAgts/CdtrAgt/FinInstnId/BICFI | Yes | It contains: - The Beneficiary BIC in case of an Instant Payment Transaction; - The Creditor BIC in case of a Liquidity Transfer Order |

3.3.2.2.13 BankToCustomerStatement (camt.053.001.08)

The Bank To Customer Statement (camt.053.001.08) is used as General Ledger message sent by TIPS to the RTGS Systems.

Furthermore, the same message type is also used as Snapshot message to convey to the relevant RTGS System the account balance status.

References/links

The schema and the related documentation in XSD/EXCEL/PDF format as well as the message examples are provided within the MyStandards repository under the following link:

<https://www.swift.com/mystandards/TIPS/camt.053.001.08>

Table 106 – BankToCustomerStatement (camt.053.001.08) – General Ledger

| Field Name | Description | XML path | Mand. | TIPS Usage |
|------------------------------------|---|---|-------|---|
| Message Identifier | Identification of the message | BkToCstmrStmnt/GrpHdr/MsgId | Yes | |
| Creation Date Time | Timestamp of the creation of the message | BkToCstmrStmnt/GrpHdr/CreDtTm | Yes | |
| Page Number | Page number for message pagination | BkToCstmrStmnt/GrpHdr/MsgPgntn/PgNb | Yes | Message pagination not used. Fixed value 1. |
| Last Page Indicator | Last Page Indicator for message pagination | BkToCstmrStmnt/GrpHdr/MsgPgntn/LastPgInd | Yes | Message pagination not used. Fixed value true. |
| Statement Identifier | Identifies the Settlement Service generating the General Ledger | BkToCstmrStmnt/Stmnt/Id | Yes | Fixed Value TIPS |
| Account Identification | Account reported | BkToCstmrStmnt/Stmnt/Acct/Id/Othr/Id | Yes | |
| Account Owner BIC | BIC of Financial Institution owning the account reported | BkToCstmrStmnt/Stmnt/Acct/Ownr/Id/OrgId/AnyBIC | Yes | |
| Account Owner country of residence | Country of residence of the Financial Institution owning the account reported | BkToCstmrStmnt/Stmnt/Acct/Ownr/CtryOfRes | Yes | |
| Balance Type | Type of the balance reported | BkToCstmrStmnt/Stmnt/Bal/Tp/CdOrPrtry/Cd | Yes | Possible values: - OPBD : for Balance at Start of Day; - CLBD : for Balance at End of Day; - ITBD : for snapshot balance. |
| Amount | Balance Amount with currency | BkToCstmrStmnt/Stmnt/Bal/Amt | Yes | |
| Credit/debit Indicator | Specifies if the Account balance is positive or negative | BkToCstmrStmnt/Stmnt/Bal/CdtDbtInd | Yes | |
| RTGS business date | RTGS business date for which the information is retrieved | BkToCstmrStmnt/Stmnt/Bal/Dt | Yes | It is filled with the stored RTGS business date. |
| Total Credit entries | Sum of Credit entries of the reported account | BkToCstmrStmnt/Stmnt/TxsSummry/TtlCdtNtries/Sum | Yes | |
| Total Debit entries | Sum of Debit entries of the reported account | BkToCstmrStmnt/Stmnt/TxsSummry/TtlDbtNtries/Sum | Yes | |

3.3.2.2.14 BankToCustomerDebitCreditNotification (camt.054.001.06)

The Bank To Customer Debit Credit Notification message is used in TIPS in order to report to the account owner the settlement of a liquidity transfer credited or debited.

References/links

The schema and the related documentation in XSD/EXCEL/PDF format as well as the message examples are provided within the MyStandards repository under the following link:

<https://www.swift.com/mystandards/TIPS/camt.054.001.06>

Table 107 – BankToCustomerDebitCreditNotification (camt.054.001.06)

| Field Name | Description | XML path | Mand. | TIPS Usage |
|---------------------------------|---|--|-------|--|
| Message Identifier | Identification of the message | BkToCstmrDbtCdtNtfctn/GrpHdr/MsgId | Yes | |
| Creation Date Time | Timestamp of the creation of the message | BkToCstmrDbtCdtNtfctn/GrpHdr/CreDtTm | Yes | |
| Notification Identifier | Identifier of the notification | BkToCstmrDbtCdtNtfctn/Ntfctn/Id | Yes | This field will be equal to the Message Identifier |
| Notification Creation Date Time | Timestamp of the creation of the notification | BkToCstmrDbtCdtNtfctn/Ntfctn/CreDtTm | Yes | This field will be equal to the Creation Date Time |
| Account Identifier | Account for which the notification has been generated | BkToCstmrDbtCdtNtfctn/Ntfctn/Acct/Id/Othr/Id | Yes | |
| Notification Amount | Amount that has been transferred to the Account | BkToCstmrDbtCdtNtfctn/Ntfctn/Ntry/Amt | Yes | |
| Credit Debit Indicator | Specifies if the Amount has been credited or debited | BkToCstmrDbtCdtNtfctn/Ntfctn/Ntry/CdtDbtInd | Yes | For credit movements, this field will be CRDT . For debit movements this field will be DBIT . |
| Status | Status of the underlying payment | BkToCstmrDbtCdtNtfctn/Ntfctn/Ntry/Sts | Yes | As notification is generated for settled movements only, this field will be BOOK . |
| Booking Date | Date and time of Booking | BkToCstmrDbtCdtNtfctn/Ntfctn/Ntry/BookgDt/DtTm | Yes | Timestamp of when the settlement occurred in TIPS |
| Bank Transaction Code Domain | Bank Transaction Code of the underlying transaction | BkToCstmrDbtCdtNtfctn/Ntfctn/Ntry/BkTxCd/Domn/Cd | Yes | Only Liquidity Transfers are reported. They belong to Payment Domain so this field will be PMNT . |

| Field Name | Description | XML path | Mand. | TIPS Usage |
|---------------------------------|---|---|-------|---|
| Bank Transaction Family Code | Bank Transaction Family Code of the underlying transaction | BkToCstmrDbtCdtNtfctn/Ntfctn/Ntry/BkTxCd/Domn/Fmly/Cd | Yes | If a credited Liquidity Transfer is reported, this field will be RCDT . If a debited Liquidity Transfer is reported, this field will be ICDT . |
| Bank Transaction SubFamily Code | Bank Transaction SubFamily Code of the underlying transaction | BkToCstmrDbtCdtNtfctn/Ntfctn/Ntry/BkTxCd/Domn/Fmly/SubFmlyCd | Yes | Only Financial Institution Credit Transfers are reported. This field will be FICT . |
| Instruction Identification | Instruction identifier for the credit transfer | /BkToCstmrDbtCdtNtfctn/Ntfctn/Ntry/NtryDtIs/TxDtIs/Refs/InstId | Yes | This field will contain the Liquidity Transfer reference |
| End to End Identification | End to end identifier for the requested credit transfer | BkToCstmrDbtCdtNtfctn/Ntfctn/Ntry/NtryDtIs/TxDtIs/Refs/EndToEndId | Yes | If not used, it must be filled with NOTPROVIDED |
| Transaction Amount | Amount that has been transferred to the Account | BkToCstmrDbtCdtNtfctn/Ntfctn/Ntry/NtryDtIs/TxDtIs/Amt | Yes | This field will be equal to the Notification Amount |
| Credit Debit Indicator | Specifies if the Amount has been credited or debited | BkToCstmrDbtCdtNtfctn/Ntfctn/Ntry/NtryDtIs/TxDtIs/CdtDbtInd | Yes | For credit movements only, this field will be CRDT . For debit movements this field will be DBIT . |
| Debtor | Debtor BIC of the Liquidity transfer order | BkToCstmrDbtCdtNtfctn/Ntfctn/Ntry/NtryDtIs/TxDtIs/RltdPtIs/Dbtr/Id/OrgId/AnyBIC | Yes | |
| Debtor Account | Account to be debited | BkToCstmrDbtCdtNtfctn/Ntfctn/Ntry/NtryDtIs/TxDtIs/RltdPtIs/dbtrAcct/Id/Othr/Id | Yes | |
| Creditor | Creditor BIC of the Liquidity transfer order | BkToCstmrDbtCdtNtfctn/Ntfctn/Ntry/NtryDtIs/TxDtIs/RltdPtIs/Cdtr/Id/OrgId/AnyBIC | Yes | |
| Creditor Account | Account to be credited | BkToCstmrDbtCdtNtfctn/Ntfctn/Ntry/NtryDtIs/TxDtIs/RltdPtIs/cdtrAcct/Id/Othr/Id | Yes | |

3.3.2.2.15 FIToFIPaymentCancellationRequest (camt.056.001.08)

The FIToFIPaymentCancellationRequest message allows instructing TIPS to trigger a recall process for a formerly settled Instant Payment transaction.

Message specification is compliant to EPC DS-05 Inter-PSP Payment Dataset as described in the SEPA Instant Credit Transfer scheme Rulebook.

TIPS receives this message by the Assigner party, checks the related access rights and the reachability of the Assignee party.

No further processing but message schema validation is performed as the message is directly forwarded to the party to which the case is assigned.

References/links

The schema and the related documentation in XSD/EXCEL/PDF format as well as the message examples are provided within the MyStandards repository under the following link:

<https://www.swift.com/mystandards/TIPS/camt.056.001.08>

Table 108 – FIToFIPaymentCancellationRequest (camt.056.001.08)

| EPC Ref. | Reference Name | EPC Description | XML path | Mand. | TIPS Usage |
|----------|--------------------------------------|--|--|-------|---|
| n/a | Assignment Identification | Uniquely identifies the case assignment. | FIToFIPmtCxlReq/Assgmt/Id | Yes | Only schema validation is performed. |
| n/a | Assigner | Party who assigns the case. | FIToFIPmtCxlReq/Assgmt/Assgnr/Agt/FinInstnId/BICFI | Yes | This field must be filled with the BIC of the originating party and is used in combination with the requestor Distinguished Name to check user access rights. |
| n/a | Assignee | Party to which the case is assigned | FIToFIPmtCxlReq/Assgmt/Assgnee/Agt/FinInstnId/BICFI | Yes | This field must be filled with the BIC of the party to which the Cancellation Request is forwarded. |
| n/a | Creation Date Time | Date and time at which the assignment was created. | FIToFIPmtCxlReq/Assgmt/CreDtTm | Yes | Only schema validation is performed. |
| n/a | Number Of Transactions | Number of individual transactions contained in the message. | FIToFIPmtCxlReq/CtrlData/NbOfTxS | No | Only a single transaction can be included. Fixed value for the Message Element is 1. |
| n/a | Underlying | Identifies the payment instruction to be cancelled. | FIToFIPmtCxlReq/Undrlyg | Yes | Only a single underlying element is allowed in TIPS. |
| n/a | Transaction Information | Set of elements used to provide information on the original transactions to which the cancellation request message refers. | FIToFIPmtCxlReq/Undrlyg/TxInf | Yes | Only a single Transaction Information element is allowed in TIPS. |
| AT-R053 | Cancellation Identification | The specific reference of the PSP initiating the Recall. | FIToFIPmtCxlReq/Undrlyg/TxInf/CxlId | Yes | |
| n/a | Original Message Identification | Point to point reference assigned by the original instructing party to unambiguously identify the original transaction. | FIToFIPmtCxlReq/Undrlyg/TxInf/OrgnlGrpInf/OrgnlMsgId | Yes | Only schema validation is performed. |
| n/a | Original Message Name Identification | Specifies the original message name identifier to which the message refers. | FIToFIPmtCxlReq/Undrlyg/TxInf/OrgnlGrpInf/OrgnlMsgNmId | Yes | Allowed values ⁶⁴ : "pacs.008.001.08" or "pacs.008.001.02" |

⁶⁴ The usage of the correct Original Message Name Identification, in relation to the moment in which the original message was sent in reference to the migration date to the 2019 message version of ISO 20022, should be ensured by the actor who generates and sends the message to TIPS: no check on the correspondence of this value with respect to the version of the original message is performed by TIPS.

| EPC Ref. | Reference Name | EPC Description | XML path | Mand. | TIPS Usage |
|----------|--|---|---|-------|---|
| n/a | Original Instruction Identification | Unique identification, as assigned by the original instructing party for the original instructed party, to unambiguously identify the original instruction. | FIToFIPmtCxlReq/Undrlyg/TxInf/OrgnlInstrld | No | Only schema validation is performed. |
| AT-T014 | Original End To End Identification | The Originator's reference of the SCT ^{Inst} Transaction. | FIToFIPmtCxlReq/Undrlyg/TxInf/OrgnlEndToEndld | Yes | Only schema validation is performed. |
| AT-T054 | Original Transaction Identification | The Originator PSP's reference of the SCT ^{Inst} Transaction message. | FIToFIPmtCxlReq/Undrlyg/TxInf/OrgnlTxld | Yes | Reference of the Instant Payment Transaction for which the Recall is requested. |
| AT-T002 | Original Interbank Settlement Amount | The amount of the SCT ^{Inst} in euro. | FIToFIPmtCxlReq/Undrlyg/TxInf/OrgnlIntrBkSttlmAmt | Yes | Amount of the Instant Payment Transaction for which the Recall is requested. |
| AT-T051 | Original Interbank Settlement Date | The Settlement Date of the SCT ^{Inst} Transaction. | FIToFIPmtCxlReq/Undrlyg/TxInf/OrgnlIntrBkSttlmDt | Yes | Settlement Date of the Instant Payment Transaction for which the Recall is requested. |
| n/a | Cancellation Reason Information | Set of elements used to provide detailed information on the cancellation reason. | FIToFIPmtCxlReq/Undrlyg/TxInf/CxlRsnInf | Yes | Only one occurrence is allowed. |
| AT-R002 | Cancellation Reason Information + Originator | Identification of the type of party initiating the R-message. | FIToFIPmtCxlReq/Undrlyg/TxInf/CxlRsnInf/Orgtr | Yes | Only schema validation is performed. |
| AT-R051 | Cancellation Reason Information + Reason | The Recall reason code. | FIToFIPmtCxlReq/Undrlyg/TxInf/CxlRsnInf/Rsn | Yes | Only schema validation is performed. |
| AT-R052 | Cancellation Reason Information + Additional Information | Additional information to AT-R051 The Recall reason code. | FIToFIPmtCxlReq/Undrlyg/TxInf/CxlRsnInf/AddtlInf | No | Only schema validation is performed. |
| n/a | Original Transaction Reference | An exact copy of all attributes of the initially sent DS-02 which is to be cancelled. | FIToFIPmtCxlReq/Undrlyg/TxInf/OrgnlTxRef | Yes | Only schema validation is performed. |
| n/a | Settlement Information | Specifies the details on the settlement. | FIToFIPmtCxlReq/Undrlyg/TxInf/OrgnlTxRef/SttlmInf | No | Only schema validation is performed. |
| AT-T001 | Scheme Identification Code | The identification code of the SCT ^{Inst} Scheme | FIToFIPmtCxlReq/Undrlyg/TxInf/OrgnlTxRef/PmtTPlnf/SvcLvl/Cd FIToFIPmtCxlReq/Undrlyg/TxInf/OrgnlTxRef/PmtTPlnf/LclInstrm/Cd | No | Only schema validation is performed. |
| AT-T008 | Category Purpose | The category purpose of the SCT ^{Inst} Instruction | FIToFIPmtCxlReq/Undrlyg/TxInf/OrgnlTxRef/PmtTPlnf/CtgyPurp | No | Only schema validation is performed. |
| AT-T009 | Remittance Information | The Remittance information. | FIToFIPmtCxlReq/Undrlyg/TxInf/OrgnlTxRef/RmtlInf | No | Only schema validation is performed. |
| AT-P006 | Originator Reference Party Name | The name of the Originator Reference Party | FIToFIPmtCxlReq/Undrlyg/TxInf/OrgnlTxRef/UltmtDbtr/Pty/Nm | No | Only schema validation is performed. |
| AT-P007 | Originator Reference Party Identification Code | The identification code of the Originator Reference Party | FIToFIPmtCxlReq/Undrlyg/TxInf/OrgnlTxRef/UltmtDbtr/Pty/ld | No | Only schema validation is performed. |
| AT-P001 | Debtor + Name | The name of the Originator. | FIToFIPmtCxlReq/Undrlyg/TxInf/OrgnlTxRef/Dbtr/Pty/Nm | No | Only schema validation is performed. |

| EPC Ref. | Reference Name | EPC Description | XML path | Mand. | TIPS Usage |
|----------|------------------------------------|--|---|-------|--------------------------------------|
| AT-P005 | Debtor + Postal Address | The address of the Originator. | FItoFIPmtCxlReq/Undrlyg/TxInf/OrgnlTxRef/Dbtr/Pty/pstlAdr | No | Only schema validation is performed. |
| AT-P004 | Debtor + Identification | The Originator identification code. | FItoFIPmtCxlReq/Undrlyg/TxInf/OrgnlTxRef/Dbtr/Pty/ld | No | Only schema validation is performed. |
| AT-D001 | Debtor Account | The IBAN of the account of the Originator. | FItoFIPmtCxlReq/Undrlyg/TxInf/OrgnlTxRef/DbtrAcct/ld/IBAN | Yes | Only schema validation is performed. |
| AT-P003 | Proxy | Specifies an alternate assumed name for the identification of the account. | FItoFIPmtCxlReq/Undrlyg/TxInf/OrgnlTxRef/DbtrAcct/Prxy | No | Only schema validation is performed. |
| AT-D002 | Debtor Agent | The BIC code of the Originator PSP. | FItoFIPmtCxlReq/Undrlyg/TxInf/OrgnlTxRef/DbtrAgent | No | Only schema validation is performed. |
| AT-C002 | Creditor Agent | The BIC code of the Beneficiary PSP. | FItoFIPmtCxlReq/Undrlyg/TxInf/OrgnlTxRef/CdtrAgent | No | Only schema validation is performed. |
| AT-E001 | Creditor + Name | The name of the Beneficiary. | FItoFIPmtCxlReq/Undrlyg/TxInf/OrgnlTxRef/Cdtr/Pty/Nm | No | Only schema validation is performed. |
| AT-E004 | Creditor + Postal Address | The address of the Beneficiary. | FItoFIPmtCxlReq/Undrlyg/TxInf/OrgnlTxRef/Cdtr/Pty/pstlAdr | No | Only schema validation is performed. |
| AT-E005 | Creditor + Identification | The Beneficiary identification code. | FItoFIPmtCxlReq/Undrlyg/TxInf/OrgnlTxRef/Cdtr/Pty/ld | No | Only schema validation is performed. |
| AT-C001 | Creditor Account | The IBAN of the account of the Beneficiary. | FItoFIPmtCxlReq/Undrlyg/TxInf/OrgnlTxRef/CdtrAcct/ld/IBAN | Yes | Only schema validation is performed. |
| AT-E003 | Proxy | Specifies an alternate assumed name for the identification of the account. | FItoFIPmtCxlReq/Undrlyg/TxInf/OrgnlTxRef/CdtrAcct/Prxy | No | Only schema validation is performed. |
| AT-E007 | Ultimate Creditor + Name | Name of the Beneficiary Reference Party. | FItoFIPmtCxlReq/Undrlyg/TxInf/OrgnlTxRef/UltmtCdtr/Pty/Nm | No | Only schema validation is performed. |
| AT-E010 | Ultimate Creditor + Identification | Identification code of the Beneficiary Reference Party. | FItoFIPmtCxlReq/Undrlyg/TxInf/OrgnlTxRef/UltmtCdtr/Pty/ld | No | Only schema validation is performed. |
| AT-T007 | Purpose | Underlying reason for the payment transaction. | FItoFIPmtCxlReq/Undrlyg/TxInf/OrgnlTxRef/Purp | No | Only schema validation is performed. |

3.3.2.2.16 FIToFIPaymentCancellationRequest (camt.056.001.08)

The FI To FI Payment Cancellation Request message is used for non-Euro settlement models and it allows instructing TIPS to trigger a recall process for a formerly settled Instant Payment transaction.

TIPS receives this message by the Assigner party, checks the related access rights and the reachability of the Assignee party.

No further processing but message schema validation is performed as the message is directly forwarded to the party to which the case is assigned.

References/links

The schema and the related documentation in XSD/EXCEL/PDF format as well as the message examples are provided within the MyStandards repository under the following link:

<https://www.swift.com/mystandards/TIPS/camt.056.001.08>

Table 109 – camt.056.001.08

| Field Name | Description | XML path | Mand. | TIPS Usage |
|--------------------------------------|---|--|-------|---|
| Assignment Identification | Uniquely identifies the case assignment. | FIToFIPmtCxlReq/Assgnmt/Id | Yes | Only schema validation is performed. |
| Assigner | Party who assigns the case. | FIToFIPmtCxlReq/Assgnmt/Assgnr/Agt/FinInstnId/BICFI | Yes | This field must be filled with the BIC of the originating party and is used in combination with the requestor Distinguish Name to check user access rights. |
| Assignee | Party to which the case is assigned | FIToFIPmtCxlReq/Assgnmt/Assgne/Agt/FinInstnId/BICFI | Yes | This field must be filled with the BIC of the party to which the Cancellation Request is forwarded. |
| Creation Date Time | Date and time at which the assignment was created. | FIToFIPmtCxlReq/Assgnmt/CreDtTm | Yes | Only schema validation is performed. |
| Number Of Transactions | Number of individual transactions contained in the message. | FIToFIPmtCxlReq/CtrlData/NbOfTxs | No | Only a single transaction can be included. Fixed value for the Message Element is 1 . |
| Underlying | Identifies the payment instruction to be cancelled. | FIToFIPmtCxlReq/Undrlyg | Yes | Only a single Underlying element is allowed in TIPS. |
| Transaction Information | Set of elements used to provide information on the original transactions to which the cancellation request message refers. | FIToFIPmtCxlReq/Undrlyg/TxInf | Yes | Only a single Transaction Information element is allowed in TIPS. |
| Cancellation Identification | The specific reference of the bank initiating the Recall. | FIToFIPmtCxlReq/Undrlyg/TxInf/Cxld | Yes | |
| Original Message Identification | Point to point reference assigned by the original instructing party to unambiguously identify the original transaction. | FIToFIPmtCxlReq/Undrlyg/TxInf/OrgnlGrpInf/OrgnlMsgId | Yes | Only schema validation is performed. |
| Original Message Name Identification | Specifies the original message name identifier to which the message refers. | FIToFIPmtCxlReq/Undrlyg/TxInf/OrgnlGrpInf/OrgnlMsgNmId | Yes | Only value pacs.008.001.08 is allowed. |
| Original Instruction Identification | Unique identification, as assigned by the original instructing party for the original instructed party, to unambiguously identify the original instruction. | FIToFIPmtCxlReq/Undrlyg/TxInf/OrgnlInstrId | No | Only schema validation is performed. |

| Field Name | Description | XML path | Mand. | TIPS Usage |
|--|--|--|-------|---|
| Original End To End Identification | The Originator's reference of the Transaction. | FIToFIPmtCxlReq/Undrlyg/TxInf/OrgnlEndToEndId | No | Only schema validation is performed. |
| Original Transaction Identification | The Originator Bank's reference of the Transaction message. | FIToFIPmtCxlReq/Undrlyg/TxInf/OrgnlTxId | Yes | Reference of the Instant Payment Transaction for which the Recall is requested. |
| Original UETR | UETR number of the Transaction message | FIToFIPmtCxlReq/Undrlyg/TxInf/OrgnlUETR | No | Only schema validation is performed. |
| Original Interbank Settlement Amount | The amount of Transaction. | FIToFIPmtCxlReq/Undrlyg/TxInf/OrgnlIntrBkSttlmAmt | Yes | Amount of the Instant Payment Transaction for which the Recall is requested. |
| Original Interbank Settlement Date | The Settlement Date of the Instant Payment Transaction. | FIToFIPmtCxlReq/Undrlyg/TxInf/OrgnlIntrBkSttlmDt | No | Settlement Date of the Instant Payment Transaction for which the Recall is requested. |
| Cancellation Reason Information | Set of elements used to provide detailed information on the cancellation reason. | FIToFIPmtCxlReq/Undrlyg/TxInf/CxlRsnInf | No | Only one occurrence is allowed. |
| Cancellation Reason Information + Originator | Identification of the type of party initiating the R-message. | FIToFIPmtCxlReq/Undrlyg/TxInf/CxlRsnInf/Orgtr | No | Only schema validation is performed. |
| Cancellation Reason Information + Reason | The Recall reason code. | FIToFIPmtCxlReq/Undrlyg/TxInf/CxlRsnInf/Rsn | Yes | Only schema validation is performed. |
| Cancellation Reason Information + Additional Information | Additional information to the Recall reason code. | FIToFIPmtCxlReq/Undrlyg/TxInf/CxlRsnInf/AddtlInf | No | Only schema validation is performed. |
| Original Transaction Reference | Attributes of the initially transaction which is to be cancelled. | FIToFIPmtCxlReq/Undrlyg/TxInf/OrgnlTxRef | Yes | Only schema validation is performed. |
| Settlement Information | Specifies the details on the settlement. | FIToFIPmtCxlReq/Undrlyg/TxInf/OrgnlTxRef/SttlmInf | No | Only schema validation is performed. |
| Scheme Identification Code | The identification code of the Scheme | FIToFIPmtCxlReq/Undrlyg/TxInf/OrgnlTxRef/PmtTpInf/SvcLvl/Cd FIToFIPmtCxlReq/Undrlyg/TxInf/OrgnlTxRef/PmtTpInf/LclInstm/Cd | No | Only schema validation is performed. |
| Category Purpose | The category purpose of the Instruction | FIToFIPmtCxlReq/Undrlyg/TxInf/OrgnlTxRef/PmtTpInf/CtgyPurp | No | Only schema validation is performed. |
| Remittance Information | The Remittance information. | FIToFIPmtCxlReq/Undrlyg/TxInf/OrgnlTxRef/RmtlInf | No | Only schema validation is performed. |
| Originator Reference Party Name | The name of the Originator Reference Party | FIToFIPmtCxlReq/Undrlyg/TxInf/OrgnlTxRef/UlmtDbtr/Pty/Nm | No | Only schema validation is performed. |
| Originator Reference Party Identification Code | The identification code of the Originator Reference Party | FIToFIPmtCxlReq/Undrlyg/TxInf/OrgnlTxRef/UlmtDbtr/Pty/Id | No | Only schema validation is performed. |
| Debtor + Name | The name of the Originator. | FIToFIPmtCxlReq/Undrlyg/TxInf/OrgnlTxRef/Dbtr/Pty/Nm | No | Only schema validation is performed. |

| Field Name | Description | XML path | Mand. | TIPS Usage |
|------------------------------------|---|---|-------|--------------------------------------|
| Debtor + Postal Address | The address of the Originator. | FIToFIPmtCxlReq/Undrlyg/TxInf/OrgnlTxRef/Dbtr/Pty/PstlAdr | No | Only schema validation is performed. |
| Debtor + Identification | The Originator identification code. | FIToFIPmtCxlReq/Undrlyg/TxInf/OrgnlTxRef/Dbtr/Pty/Id | No | Only schema validation is performed. |
| Debtor Account | The account of the Originator. | FIToFIPmtCxlReq/Undrlyg/TxInf/OrgnlTxRef/Dbtr/ Acct | No | Only schema validation is performed. |
| Debtor Account Identification | Identification of the Debtor Account | FIToFIPmtCxlReq/Undrlyg/TxInf/OrgnlTxRef/Dbtr/ Acct/Id | Yes | Only schema validation is performed. |
| Debtor Account + Type | Debtor Account type used for Alias/Proxy | FIToFIPmtCxlReq/Undrlyg/TxInf/OrgnlTxRef/Dbtr/ Acct/Tp | No | Only schema validation is performed. |
| Debtor Account + Name | The Alias or Proxy of the account of the Debtor. | FIToFIPmtCxlReq/Undrlyg/TxInf/OrgnlTxRef/Dbtr/ Acct/Nm | No | Only schema validation is performed. |
| Debtor Agent | The identification of the Originator Bank. | FIToFIPmtCxlReq/Undrlyg/TxInf/OrgnlTxRef/Dbtr/ Agt | No | Only schema validation is performed. |
| Creditor Agent | The identification of the Beneficiary Bank. | FIToFIPmtCxlReq/Undrlyg/TxInf/OrgnlTxRef/Cdtr/ Agt | No | Only schema validation is performed. |
| Creditor + Name | The name of the Beneficiary. | FIToFIPmtCxlReq/Undrlyg/TxInf/OrgnlTxRef/Cdtr/ Pty/Nm | No | Only schema validation is performed. |
| Creditor + Postal Address | The address of the Beneficiary. | FIToFIPmtCxlReq/Undrlyg/TxInf/OrgnlTxRef/Cdtr/ Pty/PstlAdr | No | Only schema validation is performed. |
| Creditor + Identification | The Beneficiary identification code. | FIToFIPmtCxlReq/Undrlyg/TxInf/OrgnlTxRef/Cdtr/ Pty/Id | No | Only schema validation is performed. |
| Creditor Account | The account of the Beneficiary. | FIToFIPmtCxlReq/Undrlyg/TxInf/OrgnlTxRef/Cdtr/ Acct | No | Only schema validation is performed. |
| Creditor Account Identification | Identification of the Creditor Account | FIToFIPmtCxlReq/Undrlyg/TxInf/OrgnlTxRef/Cdtr/ Acct/Id | Yes | Only schema validation is performed. |
| Creditor Account + Type | Creditor Account type used for Alias/Proxy | FIToFIPmtCxlReq/Undrlyg/TxInf/OrgnlTxRef/Cdtr/ Acct/Tp | No | Only schema validation is performed. |
| Creditor Account + Name | The Alias or Proxy of the account of the Creditor. | FIToFIPmtCxlReq/Undrlyg/TxInf/OrgnlTxRef/Cdtr/ Acct/Nm | No | Only schema validation is performed. |
| Ultimate Creditor + Name | Name of the Beneficiary Reference Party. | FIToFIPmtCxlReq/Undrlyg/TxInf/OrgnlTxRef/Ultn/ tCdtr/Pty/Nm | No | Only schema validation is performed. |
| Ultimate Creditor + Identification | Identification code of the Beneficiary Reference Party. | FIToFIPmtCxlReq/Undrlyg/TxInf/OrgnlTxRef/Ultn/ tCdtr/Pty/Id | No | Only schema validation is performed. |
| Purpose | Underlying reason for the payment transaction. | FIToFIPmtCxlReq/Undrlyg/TxInf/OrgnlTxRef/Purp | No | Only schema validation is performed. |

3.3.2.2.17 ResolutionOfInvestigation (camt.029.001.09)

The Resolution of Investigation message is used for non-Euro settlement models and it is sent by the Assignee party of a FIToFIPaymentCancellationRequest (Recall), triggered by an Assigner party for a formerly settled Instant Payment transaction, as a negative response. The Recall's Assignee party becomes the Assigner party of the negative answer.

Additionally, the [ResolutionOfInvestigation](#) message can be sent in reply to a Request for Status Update on a Recall.

TIPS receives this message by the Assignee party, checks the related access rights and the reachability of the Assigner party.

No further processing but message schema validation is performed as the message is directly forwarded to the party which formerly triggered the Recall process.

References/links

The schema and the related documentation in XSD/EXCEL/PDF format as well as the message examples are provided within the MyStandards repository under the following link:

<https://www.swift.com/mystandards/TIPS/camt.029.001.09>

Table 110 – camt.029.001.09

| Field Name | Description | XML path | Mand. | TIPS Usage |
|--------------------------------------|--|--|-------|---|
| Assignment + Identification | Uniquely identifies the case assignment. | RsltnOfInvstgtn/Assgnmt/Id | Yes | Only schema validation is performed. |
| Assigner | Party who sends the Resolution of Investigation message. | RsltnOfInvstgtn/Assgnmt/Assgnr/Agt/FinInstnId/BICFI | Yes | This field must be filled with the BIC of the party sending the Resolution of Investigation message and is used in combination with the requestor Distinguish Name to check user access rights. |
| Assignee | Party to which the case is assigned | RsltnOfInvstgtn/Assgnmt/Assgne/Agt/FinInstnId/BICFI | Yes | This field must be filled with the BIC of the party to which the Resolution of Investigation message is forwarded. |
| Assignment + Creation Date Time | Date and time at which the assignment was created. | RsltnOfInvstgtn/Assgnmt/CreDtTm | Yes | Only schema validation is performed. |
| Status + Confirmation | Specifies the status of the investigation, in a coded form. | RsltnOfInvstgtn/Sts/Conf | Yes | Possible values are checked within schema validation. |
| Cancellation Status Identification | Unique and unambiguous identifier of a cancellation request status, as assigned by the assigner. | RsltnOfInvstgtn/CxlDtls/TxInfAndSts/CxlStsId | Yes | Only schema validation is performed. |
| Original Message Identification | Message Identification of the originating message | RsltnOfInvstgtn/CxlDtls/TxInfAndSts/OrgnlGrpInf/OrgnlMsgId | Yes | Only schema validation is performed. |
| Original Message Name Identification | Message identifier of the originating message | RsltnOfInvstgtn/CxlDtls/TxInfAndSts/OrgnlGrpInf/OrgnlMsgNmId | Yes | Possible allowed value is: - pacs.008.001.08 |

| Field Name | Description | XML path | Mand. | TIPS Usage |
|---|--|--|-------|---|
| Original Instruction Identification | Unique identification, as assigned by the original instructing party for the original instructed party | RsltnOfInvstgtn/CxlDtIs/TxInfAndSts/OrgnIInstrId | No | Only schema validation is performed. |
| Original End To End Identification | The Originator's reference of the Transaction | RsltnOfInvstgtn/CxlDtIs/TxInfAndSts/OrgnIEndToEndId | No | Only schema validation is performed. |
| Original Transaction Identification | The Originator Bank's reference number of the Transaction message | RsltnOfInvstgtn/CxlDtIs/TxInfAndSts/OrgnITxId | Yes | Only schema validation is performed. |
| Original UETR | UETR number of the Transaction message | RsltnOfInvstgtn/CxlDtIs/TxInfAndSts/OrgnIUETR | No | Only schema validation is performed. |
| Transaction Cancellation Status | Specifies the status of the transaction cancellation request. | RsltnOfInvstgtn/CxlDtIs/TxInfAndSts/TxCxlSts | Yes | Possible values are checked within schema validation. |
| Cancellation Status Reason Information | Set of elements used to provide detailed information on the cancellation status reason. | RsltnOfInvstgtn/CxlDtIs/TxInfAndSts/CxlStsRsnInf | Yes | Only schema validation is performed. |
| Cancellation Status Reason Information + Originator | The Name of the Beneficiary or The BIC code of the Beneficiary Bank | RsltnOfInvstgtn/CxlDtIs/TxInfAndSts/CxlStsRsnInf/Orgtr | No | Only schema validation is performed. |
| Cancellation Status Reason Information + Reason | The Reason Code for non-acceptance of the Recall. | RsltnOfInvstgtn/CxlDtIs/TxInfAndSts/CxlStsRsnInf/Rsn | Yes | Only schema validation is performed. |
| Cancellation Status Reason Information + Reason ++ Code | Reason for the cancellation status, in a coded form. | RsltnOfInvstgtn/CxlDtIs/TxInfAndSts/CxlStsRsnInf/Rsn/Cd | Yes | Only schema validation is performed. |
| Cancellation Status Reason Information + Reason ++ Proprietary | Reason for the status, in a proprietary form. | RsltnOfInvstgtn/CxlDtIs/TxInfAndSts/CxlStsRsnInf/Rsn/Prtry | Yes | Only schema validation is performed. |
| Cancellation Status Reason Information + Additional Information | Further details on the cancellation status reason. | RsltnOfInvstgtn/CxlDtIs/TxInfAndSts/CxlStsRsnInf/AddtlInf | No | Only schema validation is performed. |
| Original Transaction Reference | Set of key elements used to identify the original transaction that is being referred to. | RsltnOfInvstgtn/CxlDtIs/TxInfAndSts/OrgnITxRef | Yes | Only schema validation is performed. |
| Interbank Settlement Amount | The amount of the transaction. | RsltnOfInvstgtn/CxlDtIs/TxInfAndSts/OrgnITxRef/IntrBkSttlmAmt | No | Only schema validation is performed. |
| Interbank Settlement Date | The Settlement Date of the Transaction. | RsltnOfInvstgtn/CxlDtIs/TxInfAndSts/OrgnITxRef/IntrBkSttlmDt | No | Only schema validation is performed. |
| Scheme Identification Code | The identification code of the Scheme | RsltnOfInvstgtn/CxlDtIs/TxInfAndSts/OrgnITxRef/PmtTplnf/SvcLv/Cd RsltnOfInvstgtn/CxlDtIs/TxInfAndSts/OrgnITxRef/PmtTplnf/LclInstrm/Cd | No | Possible values are checked within schema validation. |
| Category Purpose | The category purpose of the Instruction | RsltnOfInvstgtn/CxlDtIs/TxInfAndSts/OrgnITxRef/PmtTplnf/CtgyPurp | No | Only schema validation is performed. |

| Field Name | Description | XML path | Mand. | TIPS Usage |
|------------------------------------|--|---|-------|--------------------------------------|
| Remittance Information | Information supplied to enable the matching of an entry with the items that the transfer is intended to settle | RsltnOfInvstgtn/CxlDtIs/TxInfAndSts/OrgnITxRef/RmtInf | No | Only schema validation is performed. |
| Ultimate Debtor + Name | The name of the Originator Reference Party. | RsltnOfInvstgtn/CxlDtIs/TxInfAndSts/OrgnITxRef/UlmtDbtr/Pty/Nm | No | Only schema validation is performed. |
| Ultimate Debtor + Identification | The identification code of the Originator Reference Party. | RsltnOfInvstgtn/CxlDtIs/TxInfAndSts/OrgnITxRef/UlmtDbtr/Pty/Id | No | Only schema validation is performed. |
| Debtor + Name | The name of the Originator. | RsltnOfInvstgtn/CxlDtIs/TxInfAndSts/OrgnITxRef/Dbtr/Pty/Nm | No | Only schema validation is performed. |
| Debtor + Postal Address | The address of the Originator. | RsltnOfInvstgtn/CxlDtIs/TxInfAndSts/OrgnITxRef/Dbtr/Pty/PstlAdr | No | Only schema validation is performed. |
| Debtor + Identification | The Originator identification code. | RsltnOfInvstgtn/CxlDtIs/TxInfAndSts/OrgnITxRef/Dbtr/Pty/Id | No | Only schema validation is performed. |
| Debtor Account | The account of the Originator. | RsltnOfInvstgtn/CxlDtIs/TxInfAndSts/OrgnITxRef/DbtrAcct | No | Only schema validation is performed. |
| Debtor Account Identification | Identification of the Debtor Account | RsltnOfInvstgtn/CxlDtIs/TxInfAndSts/OrgnITxRef/DbtrAcct/Id | Yes | Only schema validation is performed. |
| Debtor Account + Type | Debtor Account type used for Alias/Proxy | RsltnOfInvstgtn/CxlDtIs/TxInfAndSts/OrgnITxRef/DbtrAcct/Tp | No | Only schema validation is performed. |
| Debtor Account + Name | The Alias or Proxy of the account of the Debtor. | RsltnOfInvstgtn/CxlDtIs/TxInfAndSts/OrgnITxRef/DbtrAcct/Nm | No | Only schema validation is performed. |
| Debtor Agent | The Identification of the Originator Bank. | RsltnOfInvstgtn/CxlDtIs/TxInfAndSts/OrgnITxRef/DbtrAgt | No | Only schema validation is performed. |
| Creditor Agent | The identification of the Beneficiary Bank. | RsltnOfInvstgtn/CxlDtIs/TxInfAndSts/OrgnITxRef/CdtrAgt | No | Only schema validation is performed. |
| Creditor + Name | The name of the Beneficiary. | RsltnOfInvstgtn/CxlDtIs/TxInfAndSts/OrgnITxRef/Cdtr/Pty/Nm | No | Only schema validation is performed. |
| Creditor + Postal Address | The address of the Beneficiary. | RsltnOfInvstgtn/CxlDtIs/TxInfAndSts/OrgnITxRef/Cdtr/Pty/PstlAdr | No | Only schema validation is performed. |
| Creditor + Identification | The Beneficiary identification code. | RsltnOfInvstgtn/CxlDtIs/TxInfAndSts/OrgnITxRef/Cdtr/Pty/Id | No | Only schema validation is performed. |
| Creditor Account | The account of the Beneficiary. | RsltnOfInvstgtn/CxlDtIs/TxInfAndSts/OrgnITxRef/CdtrAcct | No | Only schema validation is performed. |
| Creditor Account Identification | Identification of the Creditor Account | RsltnOfInvstgtn/CxlDtIs/TxInfAndSts/OrgnITxRef/CdtrAcct/Id | Yes | Only schema validation is performed. |
| Creditor Account + Type | Creditor Account type used for Alias/Proxy | RsltnOfInvstgtn/CxlDtIs/TxInfAndSts/OrgnITxRef/CdtrAcct/Tp | No | Only schema validation is performed. |
| Creditor Account + Name | The Alias or Proxy of the account of the Creditor. | RsltnOfInvstgtn/CxlDtIs/TxInfAndSts/OrgnITxRef/CdtrAcct/Nm | No | Only schema validation is performed. |
| Ultimate Creditor + Name | Name of the Beneficiary Reference Party. | RsltnOfInvstgtn/CxlDtIs/TxInfAndSts/OrgnITxRef/UlmtCdtr/Pty/Nm | No | Only schema validation is performed. |
| Ultimate Creditor + Identification | Identification code of the Beneficiary Reference Party. | RsltnOfInvstgtn/CxlDtIs/TxInfAndSts/OrgnITxRef/UlmtCdtr/Pty/Id | No | Only schema validation is performed. |

| Field Name | Description | XML path | Mand. | TIPS Usage |
|------------|--|---|-------|--------------------------------------|
| Purpose | Underlying reason for the payment transaction. | RsltnOfInvstgtn/CxlDtls/TxInfAndSts/OrgnITxRef/Purp | No | Only schema validation is performed. |

3.3.2.3. Account Management (acmt)

3.3.2.3.1 AccountRequestAcknowledgement (acmt.010.001.02)

The Account Request Acknowledgement message is sent by TIPS upon successful processing of a formerly instructed Account Excluded Mandate Maintenance Request message to the sender.

This message notifies the sender that the blocking status of an account or CMB has been changed.

References/links

The schema and the related documentation in XSD/EXCEL/PDF format as well as the message examples are provided within the MyStandards repository under the following link:

<https://www.swift.com/mystandards/TIPS/acmt.010.001.02>

Table 111 – AccountRequestAcknowledgement (acmt.010.001.02)

| Field Name | Description | XML path | Mand. | TIPS Usage |
|-------------------------------------|---|--------------------------------|-------|--|
| Request Type | Type of acknowledged request. | AcctReqAck/Refs/ReqTp | Yes | Only possible value is: - MNTN: Maintenance |
| Message Identification | Identification of the message. | AcctReqAck/Refs/MsgId/Id | Yes | |
| Creation Date Time | Date of creation of the message. | AcctReqAck/Refs/MsgId/CreDtTm | Yes | |
| Process Identification | Identification of the process. | AcctReqAck/Refs/PrclId/Id | Yes | Not used in TIPS but required by ISO Standards. This field is filled with the same content of the Message Identifier. |
| Process Date Time | Date of creation of the message. | AcctReqAck/Refs/PrclId/CreDtTm | Yes | Not used in TIPS but required by ISO Standards. This field is filled with the same content of the Creation Date Time. |
| Acknowledged Message Identification | Identification of the originating Account Excluded Maintenance Request message. | AcctReqAck/Refs/AckdMsgId/Id | Yes | |

| Field Name | Description | XML path | Mand. | TIPS Usage |
|---------------------------------|---|--|-------|--|
| Acknowledged Date Time | Date of the acknowledgement of the message. | AcctReqAck/Refs/AckdMsgId/CreDtTm | Yes | Not used in TIPS but required by ISO Standards. This field is filled with the same content of the Creation Date Time. |
| Status | Specifies the status of the Account Excluded Maintenance Request message. | AcctReqAck/Refs/Sts | Yes | Only possible status is: - COMP : Completed |
| Account Identification | Identification of the account or CMB related to the originating Account Excluded Maintenance Request message. | AcctReqAck/AcctId/Id/Othr/Id | Yes | |
| Currency | Currency of the account or CMB related to the originating Account Excluded Maintenance Request message. | AcctReqAck/AcctId/Ccy | Yes | |
| Organisation Identification | BIC of the TIPS Actor owning the account or CMB User. | AcctReqAck/OrgId/AnyBIC | Yes | This field must be filled either with the BIC of the account owner or the BIC of the CMB user. |
| Account Servicer Identification | BIC of the TIPS actor owning the account, | AcctReqAck/AcctSvcrId/FinInstnId/BICFI | Yes | This field must be filled with the BIC of the account owner. |

3.3.2.3.2 AccountRequestRejection (acmt.011.001.02)

The Account Request Rejection message is sent by TIPS upon rejection of a formerly instructed Account Excluded Maintenance Request message to the sender.

This message notifies the sender that the request to modify the blocking status of the account or CMB has been rejected.

References/links

The schema and the related documentation in XSD/EXCEL/PDF format as well as the message examples are provided within the MyStandards repository under the following link:

<https://www.swift.com/mystandards/TIPS/acmt.011.001.02>

Table 112 – AccountRequestRejection (acmt.011.001.02)

| Field Name | Description | XML path | Mand. | TIPS Usage |
|---------------------------------|---|--|-------|--|
| Request Type | Type of rejected request. | AcctReqRjctn/Refs/RjctdReqTp | Yes | Only possible value is: - MNTN: Maintenance |
| Rejection Reason | Reason of the message rejection | AcctReqRjctn/Refs/RjctnRsn | Yes | Reports the detailed error information |
| Rejected Request Identifier | Identification of the rejected request message. | AcctReqRjctn/Refs/RjctdReqId/Id | Yes | |
| Rejected Request Date Time | Date of creation of the message. | AcctReqRjctn/Refs/RjctdReqId/CreDtTm | Yes | Not used in TIPS but required by ISO Standards. This field is filled with the same content of the Creation Date Time. |
| Message Identification | Identification of the message. | AcctReqRjctn/Refs/MsgId/Id | Yes | |
| Creation Date Time | Date of creation of the message. | AcctReqRjctn/Refs/MsgId/CreDtTm | Yes | |
| Process Identification | Identification of the process. | AcctReqRjctn/Refs/PrclId/Id | Yes | Not used in TIPS but required by ISO Standards. This field is filled with the same content of the Message Identifier. |
| Process Date Time | Date of creation of the message. | AcctReqRjctn/Refs/PrclId/CreDtTm | Yes | Not used in TIPS but required by ISO Standards. This field is filled with the same content of the Creation Date Time. |
| Account Servicer Identification | BIC of the TIPS Actor owning the account, | AcctReqRjctn/AcctSvcrId/FinInstnId/BICFI | Yes | This field must be filled with the BIC of the account owner. |
| Organisation Identification | BIC of the TIPS Actor owning the account or CMB User. | AcctReqRjctn/OrgId/AnyBIC | Yes | This field must be filled either with the BIC of the account owner or the BIC of the CMB user. |

3.3.2.3.3 AccountExcludedMandateMaintenanceRequest (acmt.015.001.02)

The Account Excluded Mandate Maintenance Request message is sent by an authorised TIPS Actor to request a change on the blocking status for an account or CMB.

If the request is successfully executed, TIPS notifies the sender with an acmt.010.001.02 message.

If the request is rejected, TIPS notifies the sender with an acmt.011.001.02 message.

References/links

The schema and the related documentation in XSD/EXCEL/PDF format as well as the message examples are provided within the MyStandards repository under the following link:

<https://www.swift.com/mystandards/TIPS/acmt.015.001.02>

Table 113 – AccountExcludedMandateMaintenanceRequest (acmt.015.001.02)

| Field Name | Description | XML path | Mand. | TIPS Usage |
|-------------------------------|--|--|-------|--|
| Message Identification | Identification of the message. | AcctExclMndtMntncReq/Refs/MsgId/Id | Yes | |
| Creation Date Time | Date of creation of the message. | AcctExclMndtMntncReq/Refs/MsgId/CreDtTm | Yes | |
| Process Identification | Identification of the message. | AcctExclMndtMntncReq/Refs/PrclId/Id | Yes | Not used in TIPS but required by ISO Standards. |
| Process Date Time | Date of creation of the message. | AcctExclMndtMntncReq/Refs/PrclId/CreDtTm | Yes | Not used in TIPS but required by ISO Standards. |
| Account Identification | Identification of the account or CMB. | AcctExclMndtMntncReq/Acct/Id/Othr/Id | Yes | |
| Currency | Currency of the account or CMB. | AcctExclMndtMntncReq/Acct/Ccy | Yes | |
| Floor Notification Amount | Specifies the value of the balance under which a notification will be sent to the account owner. | AcctExclMndtMntncReq/Acct/FlrNtfctnAmt | No | Not used in TIPS. Usage is described in CRDM documentation. |
| Ceiling Notification Amount | Specifies the value of the balance above which a notification will be sent to the account owner. | AcctExclMndtMntncReq/Acct/ClngNtfctnAmt | No | Not used in TIPS. Usage is described in CRDM documentation. |
| Closing Date | Date when the account will be or was closed. | AcctExclMndtMntncReq/Acct/ClsgDt | No | Not used in TIPS. Usage is described in CRDM documentation. |
| Restriction Modification Code | Specifies the type of change. | AcctExclMndtMntncReq/Acct/Rstrctn/ModCd | Yes | Possible values: - ADDD : Block - DELE : Unblock |
| Restriction Type Code | Type of the Restriction. | AcctExclMndtMntncReq/Acct/Rstrctn/Rstrctn/RstrctnTp/Cd | Yes | Possible values are: - TACR : Block for credit; - TADE : Block for debit; - TABO : Block for both debit and credit |
| Restriction Valid From | Date from which the Restriction is valid. | AcctExclMndtMntncReq/Acct/Rstrctn/Rstrctn/VldFr | Yes | Not used in TIPS. |

| Field Name | Description | XML path | Mand. | TIPS Usage |
|---------------------------------|--|--|-------|---|
| Account Servicer Identification | BIC of the TIPS Actor owning the account. | AcctExclMndtMntncReq/AcctSvcrld/FinInstnld/BICFI | Yes | This field must be filled with the BIC of the account owner. It is used in combination with the requestor DN to check user access rights. The Account Servicer Identification is enforced by TIPS only when the DN who sent the message is authorised at participant level. |
| Organisation | Organised structure that is set up for a particular purpose. | AcctExclMndtMntncReq/Org | Yes | Any element included in this message component which are mandatory in ISO 20022 Standard, are not used in TIPS. |

3.3.2.4. Reference Data (reda)

3.3.2.4.1 PartyStatusAdvice (reda.016.001.01)

The Party Status Advice message is sent by TIPS to report the results of the execution of the related Party Modification Request to the requesting Central Bank.

The XSD schema is shared with Common Reference Data Management to enable users to use a single implementation for the two services.

References/links

The schema and the related documentation in XSD/EXCEL/PDF format as well as the message examples are provided within the MyStandards repository under the following link:

<https://www.swift.com/mystandards/TIPS/reda.016.001.01>

Table 114 – PartyStatusAdvice (reda.016.001.01)

| Field Name | Description | XML path | Mand. | TIPS Usage |
|---------------------------------|--|--------------------------------------|-------|---|
| Message Identification | Identification of the message. | PtyStsAdv/MsgHdr/Msgld | Yes | |
| Original Message Identification | Identification of the originating Party Modification Request message. | PtyStsAdv/MsgHdr/OrgnlBizInstr/Msgld | Yes | |
| Status | Status of the execution of the originating Party Modification Request message. | PtyStsAdv/PtySts/Sts | Yes | Possible values: - COMP : Completed - REJT : Rejected |

| Field Name | Description | XML path | Mand. | TIPS Usage |
|----------------------------------|--|---|-------|---|
| Status Reason | Additional information on rejected requests. | PtyStsAdvc/PtySts/StsRsn | No | This component will be included only in case of a rejected Party Modification Request message. |
| Error Code | Error code raised during the processing of the originating Party Modification Request message. | PtyStsAdvc/PtySts/StsRsn/Rsn/Prtry | Yes | This component will be included only in case of a rejected Party Modification Request message. |
| Additional Information | Possible additional text information to the requestor. | PtyStsAdvc/PtySts/StsRsn/Addtllnf | No | Not currently used in TIPS. |
| Related Party Identification | Unique identification to unambiguously identify the party within the system. | PtyStsAdvc/PtySts/SysPtyId/Id/Id/AnyBIC | Yes | This field will be included only in case of completed Party Modification Request messages. BIC of the TIPS Participant or Ancillary System for which the change of blocking status is requested. |
| Responsible Party Identification | Unique identification to unambiguously identify the party within the system. | PtyStsAdvc/PtySts/SysPtyId/RspnsblPtyId/Id/AnyBIC | Yes | This field will be included only in case of completed Party Modification Request messages. BIC of the Central Bank requesting the change of blocking status for a TIPS Participant or Ancillary System they are responsible for. |

3.3.2.4.2 PartyModificationRequest (reda.022.001.01)

The Party Modification Request message is sent by a Central Bank to request a change on the blocking status for a TIPS Participant or an Ancillary System.

The sender is notified by TIPS with a reda.016.001.01 message with the result of the execution.

The XSD schema is shared with Common Reference Data Management to enable users to use a single implementation for the two services.

References/links

The schema and the related documentation in XSD/EXCEL/PDF format as well as the message examples are provided within the MyStandards repository under the following link:

<https://www.swift.com/mystandards/TIPS/reda.022.001.01>

Table 115 – PartyModificationRequest (reda.022.001.01)

| Field Name | Description | XML path | Mand. | TIPS Usage |
|----------------------------------|--|---|-------|--|
| Message Identification | Identification of the message. | PtyModReq/MsgHdr/MsgId | Yes | |
| Related Party Identification | Unique identification to unambiguously identify the party within the system. | PtyModReq/SysPtyId/Id/Id/AnyBIC | Yes | BIC of the TIPS Participant or Ancillary Systems for which the change of blocking status is requested. |
| Responsible Party Identification | Unique identification to unambiguously identify the party within the system. | PtyModReq/SysPtyId/RspnsblPtyId/Id/AnyBIC | Yes | Not used in TIPS. The authorisation is checked at DN level which must belong to a Central Bank user. |
| Scope Indication | Specifies the type of requested modification. | PtyModReq/Mod/Scplndctn | Yes | Possible values: - INSE : Block; - DELT : Unblock. |
| System Party | Specifies the party reference data, as assigned by the system. | PtyModReq/Mod/ReqdMod/SysPtyDt | Yes | Not used in TIPS but required for CRDM functionality implementation. |
| Party Identification | Unique identification to unambiguously identify the party within the system. | PtyModReq/Mod/ReqdMod/PtyId | Yes | Not used in TIPS but required for CRDM functionality implementation. |
| Party Name | Specifies the name by which a party is known and which is usually used to identify that party. | PtyModReq/Mod/ReqdMod/PtyNm | Yes | Not used in TIPS but required for CRDM functionality implementation. |
| Technical Address | Unique technical address to unambiguously identify a party for receiving messages from the executing system. | PtyModReq/Mod/ReqdMod/TechAdr | Yes | Not used in TIPS but required for CRDM functionality implementation. |
| Party Address | Information that locates and identifies a specific address, as defined by postal services. | PtyModReq/Mod/ReqdMod/PtyAdr | Yes | Not used in TIPS but required for CRDM functionality implementation. |
| System Restriction | Specifies the date from which the restriction is valid. | PtyModReq/Mod/ReqdMod/SysRstrctn/VldFr | Yes | Not used in TIPS but required for CRDM functionality implementation. |
| Valid To | Specifies the date until which the restriction is valid. | PtyModReq/Mod/ReqdMod/SysRstrctn/VldTo | No | Not used in TIPS. |

| Field Name | Description | XML path | Mand. | TIPS Usage |
|---------------------------|---|-------------------------------------|-------|---|
| Restriction Type | Specifies the identification of a restriction. | PtyModReq/Mod/ReqdMod/SysRstrctn/Tp | Yes | Possible values are: - TPCR : Block for credit; - TPDB : Block for debit; - TPBO : Block for both debit and credit. |
| Market Specific Attribute | Additional attributes defined by a system entity for a party. | PtyModReq/Mod/ReqdMod/MktSpfcAttr | Yes | Not used in TIPS but required for CRDM functionality implementation. |

4. Appendices

4.1. Business Rules

| Business process | BR Name | Check ID | Input Fields and parameters | Business check | Error codes | Error Description |
|--|----------------------------------|----------|---|--|---|--|
| All | Access Rights check | 000001 | Sender User Role Entity | The DN of the Message sender as User of the Party is assigned to privilege XXX through its own role in the User Role Entity. List of couples service - privilege: - XXX - YYY | If no row is present: - error code DS14 | The user is unknown on the server |
| Instant Payment transaction business process | Duplicate check | 000002 | Original Transaction Identification Debtor Agent System parameter: data retention period | The couple (Original Transaction Identification, Debtor Agent) must not exist in the list of transactions of the last X days, where X is equal to the system parameter " Retention Period " ⁶⁵ | If a couple (Original Transaction Identification, Debtor Agent) already exists: - error code AM05 | |
| Instant Payment transaction business process | Timeout Check - Originator Side | 010001 | Acceptance Date Time Parameter "SCT ^{Inst} Timestamp Timeout" Parameter "Originator Side Offset" Parameter "Acceptable Future Time Window" Current timestamp | The "Acceptance Date Time" of the message sent by the Originator Participant, Ancillary System or Instructing Party must respect this check: Acceptance Date Time < (current timestamp + Acceptable Future Time Window) current timestamp < (Acceptance Date Time + SCT^{Inst} Timestamp Timeout + Originator Side Offset) | If the check is not respected: - error code AB06 | Timeout debtor side exceeded or "Acceptance datetime" too far in the future – acceptable future offset exceeded. |
| Instant Payment transaction business process | Timeout Check - Beneficiary Side | 010002 | Acceptance Date Time Parameter "SCT ^{Inst} Timestamp Timeout" Parameter "Beneficiary Side Offset" Current timestamp | The "Acceptance Date Time" of the message sent for initiating the transaction must respect this check: current timestamp < (Acceptance Date Time + SCT^{Inst} Timestamp Timeout + Beneficiary Side Offset) | If the check is not respected: - error code AB05 to the Originator Side - error code TM01 to the Beneficiary side | Timeout creditor side exceeded |

⁶⁵ TIPS maintains a list of received messages for its own internal consistency. For this reason, based on this buffer, TIPS could still detect the duplicate even after the retention period.

| Business process | BR Name | Check ID | Input Fields and parameters | Business check | Error codes | Error Description |
|---|--------------------------------------|----------|--|--|---|---|
| Instant Payment transaction business process | Timeout Check - Missing answer | 010003 | Transaction acceptance time Parameter "SCT ^{Inst} Timestamp Timeout" Parameter "Beneficiary Side Offset" Current timestamp | The "Acceptance Date Time" of the transaction must respect this check: current timestamp < (Acceptance Date Time + SCT^{Inst} Timestamp Timeout + Beneficiary Side Offset) | If the check is not respected: - error code AB08 to the Originator Side - error code TM01 to the Beneficiary side | Timeout creditor side - missing answer in the proper time |
| Instant Payment transaction business process Recall business process | Originator Account or CMB existence | 000003 | Debtor Agent Settlement amount Business Date | The system verifies that in table "Authorised Account User" the Debtor Agent exists and it is linked to one and only one Account, having type either "TIPS Account" or "TIPS AS Technical Account", that in table "Cash Accounts" has the currency equal to the one defined in the Settlement amount and is open for the current Business Date. If no account exists, the system verifies that in table "Authorised Account User" the Debtor Agent exists and it is linked to one and only one CMB linked to an Account that has the currency equal to the one defined in the Settlement amount and open for the current Business Date. | If the check is not respected: - error code DNOR | Originator Account or CMB not found – not existing or not yet open or already closed |
| All | Instructing Party authorised | 000004 | Sender Debtor Agent | For instant payment and recall operations, the system checks the existence of the couple (Sender, Debtor Agent) in the entity "Inbound DN-BIC Routing". For queries and liquidity transfers the system checks that the Sender is defined as an Instructing Party for the relevant Account Owner. | If no row is present: - DNOR error code is returned | |
| Instant Payment transaction business process Recall business process | Beneficiary Account or CMB existence | 000005 | Creditor Agent Settlement amount Business Date | The system verifies that in table "Authorised Account User" the Creditor Agent exists and it is linked to one and only one Account, having type either "TIPS Account" or "TIPS AS Technical Account", that in table "Cash Accounts" has the currency equal to the one defined in the Settlement amount and is open for the current Business Date. If no Account exists, the system verifies that in table "Authorised Account User" the Creditor Agent exists and it is linked to one and only one CMB linked to an Account that has the currency equal to the one defined in the Settlement amount and open for the current Business Date. | If the check is not respected: - error code CNOR | Beneficiary Account or CMB not found – not existing or not yet open or already closed |
| Instant Payment transaction business process | Maximum Amount not Exceeded | 010005 | Settlement amount Parameter "Maximum Amount" | The " Maximum Amount " parameter for the currency of the transaction is selected. The "Settlement amount" of the message must be lower than or equal to the "Maximum Amount". | If the check is not respected: - return error code AM02 | Amount exceeds the maximum authorised amount |

| Business process | BR Name | Check ID | Input Fields and parameters | Business check | Error codes | Error Description |
|--|-------------------------------------|----------|---|---|---|--|
| <p>Instant Payment transaction business process</p> <p>Recall business process</p> | Originator Account/CMB not blocked | 000006 | Debtor Agent Settlement amount Business Date | <p>The system selects the Originator account/CMB from the Debtor Agent as follows:</p> <ul style="list-style-type: none"> - in the table "Authorised Account User" the system looks up the row related to the Debtor Agent linked to only one account whose type is either "TIPS Account" or "TIPS AS Technical Account" that in table "Cash Accounts" has the currency equal to the one defined in the Settlement amount and is open for the current Business Date - If no Account is returned, queries that in table "Cash Accounts" the row related to the Debtor Agent linked in table "Authorised Account User" to one and only one "TIPS CMB", for the currency equal to the one defined in the Settlement amount and open for the current Business Date. <p>If an Originator account is involved, the system checks that the Blocking Status of the account is not "Blocked for credit and debit" or "Blocked for debit". If an Originator CMB is involved, the system checks that the Blocking Status of the CMB and the related account are not "Blocked for credit and debit" or "Blocked for debit".</p> <p>If the previous checks are passed, the system checks that the TIPS Participant or Ancillary System related to the Debtor Agent and to the account (directly involved or involved through a CMB) has Blocking Status different from "Blocked for credit and debit" or "Blocked for debit".</p> | <p>If the check is not respected: - return error code TBL1</p> | The owner of the debtor account or the debtor account/CMB is blocked |
| <p>Instant Payment transaction business process</p> <p>Recall business process</p> | Beneficiary Account/CMB not blocked | 000007 | Creditor Agent Settlement amount Business Date | <p>The system selects the Beneficiary account/CMB from the Creditor Agent as follows:</p> <ul style="list-style-type: none"> - in the table "Authorised Account User" the system looks up the row related to the Creditor Agent linked to only one account whose, type is either "TIPS Account" or "TIPS AS Technical Account" that in table "Cash Accounts" has the currency equal to the one defined in the Settlement amount and it is open for the current Business Date - if the previous step fails, the system selects the row related to the Creditor Agent linked in table "Authorised Account User" to one and only one "TIPS CMB"; this CMB must have the currency equal to the one defined in the Settlement amount and must be open for the current Business Date. <p>If a Beneficiary account is involved, the system checks that the Blocking Status of the account is not "Blocked for credit and debit" or "Blocked for credit". If a Beneficiary CMB is involved, the system checks that the Blocking Status of the CMB and the related account are not "Blocked for credit and debit" or "Blocked for credit".</p> <p>If the previous checks are passed, the system checks that the TIPS Participant or Ancillary System related to the Creditor Agent and to the Beneficiary account (directly involved or involved through a CMB) has Blocking Status different from "Blocked for credit and debit" or "Blocked for credit".</p> | <p>If the check is not respected: - return error code TBL2</p> | The owner of the creditor account or the creditor account/CMB is blocked |

| Business process | BR Name | Check ID | Input Fields and parameters | Business check | Error codes | Error Description |
|---|--|----------|---|---|--|--|
| Instant Payment transaction business process Recall business process | Available amount not exceeded | 000008 | Debtor Agent Settlement amount Business Date | The system selects the Originator account/CMB from the Debtor Agent as follows: - in the table "Authorised Account User" the system looks up the row related to the Debtor Agent linked to only one account whose type is either "TIPS Account" or "TIPS AS Technical Account" hat; in table "Cash Accounts" has the currency equal to the one defined in the Settlement amount and it is open for the current Business Date - if the previous step fails, the system selects the row related to the Debtor Agent linked in table "Authorised Account User" to one and only one "TIPS CMB"; this CMB must have the currency equal to the one defined in the Settlement amount and must be open for the current Business Date. Then the system retrieves the available balance of the Originator account (directly involved or linked to the Debiting CMB) and/or the Debiting CMB Headroom. The system checks that the Settlement amount is lower than or equal to the Originator account available balance. If a Debiting CMB is involved, the system checks that (i) the Settlement amount is lower than or equal to its limit headroom is lower and that (ii) the Settlement amount is lower than or equal to the Originator account available balance. | If the check is not respected: - return error code AM23 | |
| Instant Payment transaction business process Recall business process | Beneficiary correctly configured | 010006 | Creditor Agent | The system checks that a unique item related to the Creditor Agent exists in the entity "Outbound DN-BIC". | If no row is or multiple rows are returned: - return error code MS01 | Beneficiary DN not found |
| Instant Payment transaction business process | Pending transaction existing | 010007 | Original Transaction Identification Debtor Agent | The system checks that a unique item related to the Original Transaction Identification and to the Debtor Agent with status "Reserved" exists in the transactional entity "Instant Payment". | If no row is or multiple rows are returned: - return error code AG09 | Transaction not found |
| Instant Payment transaction business process Recall business process | Instructing Party authorised – creditor side | 000009 | Sender Creditor Agent | The system checks the existence of the couple (Sender, Creditor Agent) in the entity "Inbound DN-BIC Routing". | If no row is present: - CNOR error code is returned | |
| Queries business process Investigation business process | Instructing Party authorised for queries | 000010 | Sender Account User/ Originator BIC | The system checks the existence of the couple (Sender, Account User/ Originator BIC) in the entity "Inbound DN-BIC Routing", or, alternatively, that the Sender is defined as an Instructing Party for the Account Owner Party. | If no row is present: Business error RJCT is returned, error code DNOR | Instructing party not authorised to send query |

| Business process | BR Name | Check ID | Input Fields and parameters | Business check | Error codes | Error Description |
|--------------------------------|---|----------|--|--|--|---|
| Queries business process | Account or CMB existence | 070001 | Account or CMB Identifier Account User | <p>For Account balance and status query, TIPS verifies that the Account or CMB Identifier corresponds to an account whose type is either "TIPS Account" or "TIPS AS Technical Account" in the table "Cash Accounts" and if the TIPS Participant, Ancillary System or Instructing Party is authorised to query on it based on the query permission.</p> <p>For CMB limit and status query, TIPS verifies that the account or CMB Identifier corresponds to a CMB in the table "CMB" and if the TIPS Participant, Ancillary System or Instructing Party is authorised to query on it based on the query permission. The system selects also the account linked to the CMB.</p> | If the check is not respected: Business error RJCT, error code DNOR | Account or CMB not found – not existing or not yet open or already closed |
| Queries business process | Query uniformity check | 070002 | Account or CMB Identifier Account User | <p>In case of multiple instances are present in the camt.003 message as search criteria, TIPS verifies that:</p> <ul style="list-style-type: none"> - all instances of 'Account or CMB Identifier' correspond to an account whose type is either "TIPS Account" or "TIPS AS Technical Account" in the table "Cash Accounts"; OR - all instances of 'Account or CMB Identifier' correspond to a CMB in the table "CMB". | In case of an uneven set of requests: business error RJCT, error code MS01 | Account balance and CMB limit are not allowed in the same message. |
| Queries business process | Payment Transaction existence for query | 070003 | Transaction Identification Originator BIC Sender | <p>The system checks that:</p> <ul style="list-style-type: none"> - an item related to the Transaction Identification and to the Originator BIC exists in the transactional entity "Instant Payment" (Data retention period not expired) - the TIPS actor is the Originator of the interested Payment transaction or the Instructing Party acting on behalf of the Participant or Reachable Party on the originator side, or Beneficiary Participant and the Instructing Party acting on behalf of the Beneficiary Participant or Reachable Party on the beneficiary side. | If no row is present: - Business error RJCT, error code AG09 | |
| Investigation business process | Payment Transaction existence | 030001 | Transaction Identification Originator BIC | <p>The system checks that:</p> <ul style="list-style-type: none"> - an item related to the Transaction Identification and to the Originator BIC exists in the transactional entity "Instant Payment" (Data retention period not expired) - the TIPS actor is the Originator of the interested Payment transaction or the Instructing Party acting on behalf of the Participant or Reachable Party on the originator side. | If no row is present: - Business error RJCT, error code AG09 | |
| Investigation business process | Investigation allowed | 030002 | Transaction Identification Originator BIC Acceptance date time SCT ^{Inst} Timestamp Timeout Investigation Offset Current timestamp | <p>Current Timestamp => (Transaction_ Acceptance Date Time + SCT^{Inst} Timestamp Timeout + Investigation Offset)</p> | If the check is not respected: - Business error RJCT, error code AG09 | Investigation not allowed for the Payment Transaction |

| Business process | BR Name | Check ID | Input Fields and parameters | Business check | Error codes | Error Description |
|-------------------------------------|---|----------|---|---|---|--|
| Investigation business process | Payment Transaction existence in final status | 030003 | Transaction Identification Originator BIC | The system checks that: - an item related to the Transaction Identification and to the Originator BIC exists in the transactional entity "Instant Payment" (Data retention period not expired) with final status - the TIPS actor is the Originator of the interested Payment transaction or the Instructing Party acting on behalf of the Participant or Reachable Party on the originator side. | The underlying instant payment is present but did not reach a final status yet - Business error RJCT, error code MS01 | |
| Liquidity Transfer business process | Creditor Account existence | 040001 | Creditor Account | The TIPS Account to be credited of an Inbound Liquidity Transfer exists with opening date equal or less than the current RTGS Business day and closing date equal or greater than the current RTGS Business day. | If the check is not respected: - error code L001 | Unknown Creditor or Creditor Account |
| Liquidity Transfer business process | Debtor Account existence | 040002 | Debtor Account Sender DN | The Debtor Account of an outbound Liquidity Transfer should be an existing TIPS Account with opening date equal or less than the current RTGS Business day and closing date equal or later than the current business day of the relevant RTGS system. The responsible Central Bank is able to initiate an Outbound Liquidity Transfer even if the closing date of the TIPS Account is exceeded (e.g. if the balance of a closed account is still greater than zero). | If the check is not respected: - error code L002 | Unknown Debtor or Debtor Account |
| Liquidity Transfer business process | Currency Check | 040003 | Transferred Amount | The currency of the incoming flow should be the same as the currency of the account to be credited/debited, otherwise the incoming Outbound, Inbound or intra-service Liquidity Transfer will be rejected. | If the check is not respected: - error code L003 | Currency of incoming flow differs from Account currency or RTGS System not configured. |
| Liquidity Transfer business process | Creditor and Creditor Account not blocked | 040004 | Creditor Creditor Account | The system checks that: - The Creditor has a Blocking Status different from "Blocked for credit and debit" or "Blocked for credit". - The Blocking Status of the account to be credited is not "Blocked for credit and debit" or "Blocked for credit". | If the check is not respected: - return error code L004 | The Creditor or the Creditor Account is blocked. |

| Business process | BR Name | Check ID | Input Fields and parameters | Business check | Error codes | Error Description |
|-------------------------------------|--|----------|---------------------------------------|--|---|---|
| Liquidity Transfer business process | Debtor and Debtor Account not blocked | 040005 | Debtor Debtor Account Sender DN | The system checks that: - The Debtor has a Blocking Status different from "Blocked for credit and debit" or "Blocked for debit". - The Blocking Status of the account to be debited is not "Blocked for credit and debit" or "Blocked for debit". The responsible Central Bank is able to initiate an Outbound Liquidity Transfer regardless of the TIPS Account's blocking status. | If the check is not respected: Business error RJCT, error code L005 | The Debtor or the Debtor Account is blocked. |
| Liquidity Transfer business process | LT Duplicate Check | 040006 | Instruction Identification Debtor | The couple (Instruction Identification, Debtor) must not exist in the list of transactions of the last X days, where X is equal to the system parameter " Retention Period " ⁶⁶ | If the check is not respected: - return error code L006 | Outbound or Inbound LT is a duplicate submission |
| Liquidity Transfer business process | Funds Check | 040007 | Transferred Amount | The Transferred Amount must be lower or equal to the Available Balance (Cash Balance) on the account to be debited. | If the check is not respected: - return error code L007 | Failure of the settlement attempt of the instruction due to insufficient cash balance |
| Liquidity Transfer business process | RTGS opening hours Check | 040008 | RTGS system data - RTGS Status | The value of the attribute "RTGS Status" is "Open" for the RTGS system. | If the check is not respected: - error code L008 | RTGS system is closed |
| Liquidity Transfer business process | Invalid status code in RTGS Answer Check | 040009 | Status code | TIPS expects that an RTGS Answer returns only one RTGS status, either 'RREJ' ⁶⁷ or 'RCON' ⁶⁸ . If the status value is neither 'RREJ' nor 'RCON' the RTGS answer will be rejected. | If the check is not respected: - error code L009 | Invalid content of the field RTGS Status |
| Liquidity Transfer business process | RTGS Access Rights Check | 040010 | Sender DN Transferred Amount | The sender DN is an existing and active RTGS DN in TIPS. The RTGS currency corresponds to the currency of the Liquidity Transfer | If the check is not respected: - error code L010 | Unknown RTGS System DN |
| Liquidity Transfer business process | Pending (Transient) order existing | 040011 | Original Message Identification | The system checks that a unique item related to the Original Message Identification with status " <i>Transient</i> " exists in TIPS. | If the check is not respected: - error code L011 | Order not found |

⁶⁶ TIPS maintains a list of received messages for its own internal consistency. For this reason, based on this buffer, TIPS could still detect the duplicate even after the retention period.

⁶⁷ RREJ (RTGS "Rejected") status code informs the sender of the Outbound Liquidity Transfer about a rejection at RTGS System level.

⁶⁸ RCON (RCON "Confirmation") status code informs the sender of the Outbound Liquidity Transfer about successful settlement at the RTGS System level.

| Business process | BR Name | Check ID | Input Fields and parameters | Business check | Error codes | Error Description |
|-------------------------------------|---|----------|--|---|---|--|
| Liquidity Transfer business process | LT Amount Check | 040012 | Transferred Amount | The Transferred Amount must be greater than zero. | If the check is not respected: - error code L012 | The amount is lower or equal to zero. |
| Liquidity Transfer business process | Intra-service LT check | 040014 | Debtor Account Creditor Account | The account to be debited for an Intra-service Liquidity Transfer shall exist, it shall have type either "TIPS Account" or "TIPS AS Technical Account", having an opening date equal or less than the current RTGS Business day and closing date equal or greater than the current RTGS Business day. The account to be credited for an Intra-service Liquidity Transfer shall exist, it shall have type either "TIPS Account" or "TIPS AS Technical Account", having an opening date equal or less than the current RTGS Business day and closing date equal or greater than the current RTGS Business day. If both accounts are of the same type, the Liquidity Transfer is rejected. | If the check is not respected: - error code L014 | Intra-service LT not allowed |
| Liquidity Transfer business process | RTGS partial closure Check | 040015 | RTGS system data - RTGS Status Sender DN | The value of the attribute "RTGS Status" is "Partially Closed" and the Sender DN corresponds to a CB user. | If the check is not respected: - error code L015 | User not authorised when the RTGS System is partially closed |
| Liquidity Transfer business process | Timeout Check - Originator Side | 040099 | Debtor Account Creditor Account | In the internal communication between TIPS and any connected RTGS system, in case of Liquidity Transfer, the Creditor Account type shall be 'CASH' while the Debtor Account type shall be 'SACC'. | If the check is not respected: - error code L099 | Cannot determine the direction of the LT order |
| Recall business process | Maximum Amount not exceeded for Returned Amount | 020001 | Returned Amount (AT-R054 DS-06) Parameter "Maximum Amount" | The " Maximum Amount " parameter for the currency of the transaction is selected. The "Returned Amount" of the message must be lower than or equal to the "Maximum Amount". | If the check is not respected: - return error code AM02 | Amount exceeds the maximum authorised amount |
| Recall business process | Duplicate check for positive Recall Response | 020002 | Return Identification Beneficiary BIC (ATC002 – DS-02 subset of DS-06) System parameter: Retention Period | The couple Return Identification and Beneficiary BIC (to be interpreted as new Originator BIC) must not exist as a couple Transaction ID/Organator BIC in the list of transactions of the last X days with status "Settled", where X is equal to the system parameter " Retention Period " ⁶⁹ . | If the check is not respected: - error code AM05 | |

⁶⁹ TIPS maintains a list of received messages for its own internal consistency. For this reason, based on this buffer, TIPS could still detect the duplicate even after the retention period.

| Business process | BR Name | Check ID | Input Fields and parameters | Business check | Error codes | Error Description |
|---------------------------|---|----------|--|---|--|---|
| Reference data management | TIPS Actor block/unblock type allowed | 050001 | Restriction Type Code | The Restriction Type Code must be TPCR (Block for credit), TPDB (Block for debit) or TPBO (Block for both debit and credit). | If the check is not respected: - error code R001 | Restriction Type for TIPS Actor not allowed |
| Reference data management | Party existence | 050002 | Related Party Identification | The party identified by the Related Party Identification must exist. | If the check is not respected: - error code R002 | Party not existing |
| Reference data management | Party type allowed | 050003 | Related Party Identification | The party identified by the Related Party Identification must be either a TIPS Participant or Ancillary System. | If the check is not respected: - error code R003 | Party Type not allowed for blocking/unblocking operations |
| Reference data management | Account/CMB block/unblock type allowed | 050005 | Restriction Type Code | The Restriction Type Code must be TACR (Block for credit), TADE (Block for debit) or TABO (Block for both debit and credit). | If the check is not respected: - error code R005 | Restriction Type for Account/CMB not allowed |
| Reference data management | Account/CMB existence | 050006 | Account Identification | The Account or CMB identified by the Account Identification must exist. | If the check is not respected: - error code R006 | Account/CMB not existing |
| Reference data management | Currency of the Account/CMB | 050007 | Currency Account Identification | The Currency must be the same of the Account/CMB specified by the Account or CMB identified by the Account Identification. | If the check is not respected: - error code R007 | Currency not correct |
| Reference data management | User allowed to block/unblock operation | 050008 | Sender DN Account Identification | <p>If the Account Identification identifies an account, the system checks that the user of a Central Bank and that the owner of the Account is under the Central Bank responsibility.</p> <p>If the Account Identification identifies a CMB, the system checks that user of the party Account owner is:</p> <ul style="list-style-type: none"> - Either a Central Bank and that the owner of the Account linked to the CMB is under the Central Bank responsibility; - Or the TIPS Participant/Ancillary System owner of the account linked to the CMB. | If the check is not respected: - error code R008 | User not allowed to block/unblock the account/CMB |
| Reference data management | CMB existence | 050020 | Account Identification CMB User BIC | The CMB identified by the Account Identification must exist and its user must be CMB User BIC. | If the check is not respected: - error code R020 | CMB not existing |

| Business process | BR Name | Check ID | Input Fields and parameters | Business check | Error codes | Error Description |
|---------------------------|--|----------|--|--|--|--|
| Reference data management | User allowed to change Limit | 050021 | Account Owner | The system checks that the party identified by the account owner is: <ul style="list-style-type: none"> - Either a Central Bank and that the owner of the account linked to the CMB is under the Central Bank responsibility; - Or the TIPS Participant/Ancillary System owner of the account linked to the CMB. | If the check is not respected: - error code R021 | User not allowed to change the Limit |
| Reference data management | Duplicate check for local reference data transaction | 050022 | Message Identification Account servicer | The combination of Message Identification and Sender BIC should not exist in the list of reference data transactions of the last X days, where X is equal to the system parameter " Retention Period " | If the check is not respected: - error code R099 | |
| EPC Report | Unique Requestor Check | 080001 | Valid From Valid To | The system checks that no more than one user at the same time is requesting the generation of the report. | S001 | Impossible to generate more than one report in parallel. |
| EPC Report | Data existence check | 080002 | Valid From Valid To | The system checks that the data for the selected period are available for the generation of the report. | S002 | Data not available for the selected period |

4.2. List of Error codes

4.2.1. List of ISO Error codes

The table below contains the exhaustive list of ISO error codes generated by TIPS in case of error detected during the validation processes.

| ISO Code | ISO Name | SEPA Core Reason as specified in the Rulebook | Comments |
|----------|---------------------------------|--|--|
| AB05 | TimeoutCreditorAgent | Transaction stopped due to timeout at the Creditor Agent. | |
| AB06 | TimeoutInstructedAgent | Transaction stopped due to timeout at the Instructed Agent. | |
| AB08 | OfflineCreditorAgent | Creditor Agent is not online. | Used in TIPS for the orphan payments |
| AG09 | PaymentNotReceived | Original payment never received. | Pending item to be confirmed not existing or already expired |
| AM02 | NotAllowedAmount | Amount exceeds the maximum authorised amount for SCT ^{Inst} | |
| AM03 | NotAllowedCurrency | Specified message amount is a non processable currency outside of existing agreement | Not present in SEPA document – introduced for checking the validity of the currency since TIPS is multi-currency |
| AM05 | Duplication | Duplicate payment | |
| AM23 | AmountExceedsSettlementLimit | Transaction amount exceeds settlement limit. | |
| CNOR | Creditor bank is not registered | Beneficiary PSP is not registered under this BIC in the CSM | |
| DNOR | Debtor bank is not registered | Originator PSP is not registered under this BIC in the CSM | |
| DS14 | UserDoesNotExist | The user is unknown on the server | Not present in SEPA document. |
| MS01 | NotSpecifiedReason | Reason not specified | Currently used for generic error when no related error code has been defined in the ISO documentation. Not present in SEPA document. |
| TM01 | InvalidCutOffTime | Time-out – maximum execution time has been exceeded | |

4.2.2. List of non-ISO Error codes

The table below contains the exhaustive list of non-ISO error codes generated by TIPS in case of error detected during the validation processes.

| Error Code | Error description |
|------------|---|
| L001 | Unknown Creditor or Creditor Account |
| L002 | Unknown Debtor or Debtor Account |
| L003 | Currency of incoming flow differs from Account currency or RTGS System not configured |
| L004 | The Creditor or the Creditor Account is blocked |
| L005 | The Debtor or the Debtor Account is blocked |
| L006 | Outbound or Inbound LT is a duplicate submission |
| L007 | Failure of the settlement attempt of the instruction due to insufficient cash balance |
| L008 | RTGS system is closed |
| L009 | Invalid content of the field RTGS Status |
| L010 | Unknown RTGS System DN |
| L011 | Order not found |
| L012 | The amount is lower or equal to zero |
| L014 | Intra-service LT not allowed |
| L015 | User not authorised when the RTGS System is partially closed |
| L099 | Cannot determine the direction of the LT order |
| R001 | Restriction Type for Actor not allowed |
| R002 | Party not existing |
| R003 | Party Type not allowed for blocking/unblocking operations |
| R005 | Restriction Type for account/CMB not allowed |
| R006 | Account/CMB not existing |
| R007 | Currency not correct |
| R008 | User not allowed to block/unblock the account/CMB |
| R020 | CMB not existing |
| R021 | User not allowed to change the Limit |
| R099 | Duplicate instruction |
| S001 | Request not allowed |
| S002 | Data not available |
| TBL1 | The owner of the debtor account or the debtor account/CMB is blocked |
| TBL2 | The owner of the creditor account or the creditor account/CMB is blocked |

4.3. List of Indicators

4.3.1. List of general SCT Inst Indicators

The table below contains the exhaustive list of general SCT Inst Indicators present in TIPS. The detailed information about these measures is defined in paragraph [1.5.7.1 “General SCT Inst”](#).

| Label | Indicator’s reference |
|------------------------------|-----------------------------|
| Period (month or quarter): | |
| SCT INST TRANSACTIONS | |
| Amount | |
| < 1.000 | TIPS.stat.1.a |
| 1.000 - 5.000 | TIPS.stat.1.b |
| 5.000 - 10.000 | TIPS.stat.1.c |
| 10000 – 15000 | TIPS.stat.1.d |
| ≥ 15.000 | TIPS.stat.1.e |
| Hour | |
| 00h00 - 06h00 CET | TIPS.stat.2.a |
| 06h00 - 12h00 CET | TIPS.stat.2.b |
| 12h00 - 18h00 CET | TIPS.stat.2.c |
| 18h00 - 00h00 CET | TIPS.stat.2.d |
| Duration of processing | |
| Within 5 seconds | TIPS.stat.3.a/TIPS.stat.4.a |
| Within 10 seconds | TIPS.stat.3.b/TIPS.stat.4.b |
| Within 15 seconds | TIPS.stat.3.c/TIPS.stat.4.c |
| Within 20 seconds | TIPS.stat.3.d/TIPS.stat.4.d |
| Within 25 seconds | TIPS.stat.3.e/TIPS.stat.4.e |
| > 25 seconds | TIPS.stat.3.f/TIPS.stat.4.f |
| no confirmation after 25 sec | TIPS.stat.4.g |
| Investigations | |
| [Number of Investigations] | TIPS.stat.5.a |

4.3.2. List of National Transactions indicators for euro currency

The table below contains the exhaustive list of general National Transactions Indicators present in TIPS. The detailed information about these measures is defined in paragraph [1.5.7.2 “National Transactions”](#).

| Label | Indicator’s reference |
|----------------------------|-----------------------|
| Period (month or quarter): | |
| NATIONAL TRANSACTIONS | |
| Transactions Per country | |

| Label | Indicator's reference |
|--|---|
| [Country code] ₁ | TIPS.stat.6.[Country code] ₁ OR [empty] |
| [...] | [...] |
| [Country code] _n | TIPS.stat.6.[Country code] _n OR [empty] |
| Unsettled Transactions Per country | |
| [Country code] ₁ | TIPS.stat.7.[Country code] ₁ OR [empty] |
| [...] | [...] |
| [Country code] _n | TIPS.stat.7.[Country code] _n OR [empty] |
| Recall Request per Country | |
| [Country code] ₁ | TIPS.stat.8.[Country code] ₁ OR [empty] |
| [...] | [...] |
| [Country code] _n | TIPS.stat.8.[Country code] _n OR [empty] |
| Unsettled Transactions Per Reason Code | |
| [Country code] ₁ [Reason code] ₁[Country code] ₁ [Reason code] _m | TIPS.stat.9.[Country code] ₁ [Reason code] ₁ |
| [...]......[...] | [...]......[...] |
| [Country code] _n [Reason code] ₁[Country code] _n [Reason code] _m | TIPS.stat.9.[Country code] _n [Reason code] _m |
| Recall Request per Reason code | |
| [Country code] ₁ [Reason code] ₁[Country code] ₁ [Reason code] _m | TIPS.stat.10.[Country code] ₁ [Reason code] ₁ |
| [...]......[...] | [...]......[...] |
| [Country code] _n [Reason code] ₁[Country code] _n [Reason code] _m | TIPS.stat.10.[Country code] _n [Reason code] _m |
| Request for Recall per Country | |
| [Country code] ₁ | TIPS.stat.11.[Country code] ₁ OR [empty] |
| [...] | [...] |
| [Country code] _n | TIPS.stat.11.[Country code] _n OR [empty] |

4.3.3. List of cross-border Transactions indicators for euro currency

The table below contains the exhaustive list of general SCT Inst Indicators present in TIPS. The detailed information about these measures is defined in paragraph [1.5.7.3 "Cross-border Transactions"](#).

| Label | Indicator's reference |
|--|---|
| Period (month or quarter): | |
| CROSS_BORDER TRANSACTIONS | |
| Transactions sent Per Originator Country | |
| [Country code] ₁ | TIPS.stat.12.[Country code] ₁ OR [empty] |
| [...] | [...] |

| Label | Indicator's reference |
|--|---|
| [Country code] _n | TIPS.stat.12.[Country code] _n OR [empty] |
| Transactions received Per Beneficiary Country | |
| [Country code] ₁ | TIPS.stat.13.[Country code] ₁ OR [empty] |
| [...] | [...] |
| [Country code] _n | TIPS.stat.13.[Country code] _n OR [empty] |
| Unsettled sent Transactions Per Originator Country | |
| [Country code] ₁ | TIPS.stat.14.[Country code] ₁ OR [empty] |
| [...] | [...] |
| [Country code] _n | TIPS.stat.14.[Country code] _n OR [empty] |
| Unsettled received Transactions Per Beneficiary Country | |
| [Country code] ₁ | TIPS.stat.15.[Country code] ₁ OR [empty] |
| [...] | [...] |
| [Country code] _n | TIPS.stat.15.[Country code] _n OR [empty] |
| Recall Request sent per Originator Country | |
| [Country code] ₁ | TIPS.stat.16.[Country code] ₁ OR [empty] |
| [...] | [...] |
| [Country code] _n | TIPS.stat.16.[Country code] _n OR [empty] |
| Recall Request received per Beneficiary Country | |
| [Country code] ₁ | TIPS.stat.17.[Country code] ₁ OR [empty] |
| [...] | [...] |
| [Country code] _n | TIPS.stat.17.[Country code] _n OR [empty] |
| Unsettled Transactions sent Per Reason Code and Originator Country | |
| [Country code] ₁ [Reason code] ₁[Country code] ₁ [Reason code] _m | TIPS.stat.18.[Country code] ₁ . [Reason code] ₁ |
| [...].[...] | [...].[...] |
| [Country code] _n [Reason code] ₁[Country code] _n [Reason code] _m | TIPS.stat.18.[Country code] _n . [Reason code] _m |
| Unsettled Transactions received Per Reason Code and Originator Country | |
| [Country code] ₁ [Reason code] ₁[Country code] ₁ [Reason code] _m | TIPS.stat.19.[Country code] ₁ . [Reason code] ₁ |
| [...].[...] | [...].[...] |
| [Country code] _n [Reason code] ₁[Country code] _n [Reason code] _m | TIPS.stat.19.[Country code] _n . [Reason code] _m |
| Recall Request sent per Reason code and Originator Country | |
| [Country code] ₁ [Reason code] ₁[Country code] ₁ [Reason code] _m | TIPS.stat.20.[Country code] ₁ . [Reason code] ₁ |

| Label | Indicator's reference |
|--|---|
| [...].[...].[...] | [...].[...].[...] |
| [Country code] _n [Reason code] ₁[Country code] _n [Reason code] _m | TIPS.stat.20.[Country code] _n [Reason code] _m |
| Recall Request received per Reason code and Beneficiary Country | |
| [Country code] ₁ [Reason code] ₁[Country code] ₁ [Reason code] _m | TIPS.stat.21.[Country code] ₁ [Reason code] ₁ |
| [...].[...].[...] | [...].[...].[...] |
| [Country code] _n [Reason code] ₁[Country code] _n [Reason code] _m | TIPS.stat.21.[Country code] _n [Reason code] _m |
| Request for Recall sent per Originator Country | |
| [Country code] ₁ | TIPS.stat.22.[Country code] ₁ OR [empty] |
| [...] | [...] |
| [Country code] _n | TIPS.stat.22.[Country code] _n OR [empty] |
| Request for Recall received per Beneficiary Country | |
| [Country code] ₁ | TIPS.stat.23.[Country code] ₁ OR [empty] |
| [...] | [...] |
| [Country code] _n | TIPS.stat.23.[Country code] _n OR [empty] |

4.3.4. List of general indicators for non-Euro currencies

The table below contains the exhaustive list of general Indicators present in TIPS for non-Euro currencies. The detailed information about these measures is defined in paragraph [1.5.8.1 "General figures"](#).

| Label | Indicator's reference |
|---------------------------------------|-----------------------|
| Period (month or quarter) | |
| Instant payments | |
| Amount | |
| < 100 SEK | TIPS.stat.M1.a |
| >= 100 SEK and < 500 SEK | TIPS.stat.M1.b |
| >= 500 SEK and < 1,000 SEK | TIPS.stat.M1.c |
| >= 1,000 SEK and < 5,000 SEK | TIPS.stat.M1.d |
| >= 5,000 SEK and < 10,000 SEK | TIPS.stat.M1.e |
| >= 10,000 SEK and < 50,000 SEK | TIPS.stat.M1.f |
| >= 50,000 SEK and < 100,000 SEK | TIPS.stat.M1.g |
| >= 100,000 SEK and <= 500,000 SEK | TIPS.stat.M1.h |
| >= 500,000 SEK and <= 1,000,000 SEK | TIPS.stat.M1.i |
| >= 1,000,000 SEK and <= 5,000,000 SEK | TIPS.stat.M1.j |

| Label | Indicator's reference |
|--|-----------------------|
| $\geq 5,000,000$ SEK and $\leq 10,000,000$ SEK | TIPS.stat.M1.k |
| $> 10,000,000$ SEK | TIPS.stat.M1.l |
| Hour | |
| 00h00 - 01h00 CET | TIPS.stat.M2.a |
| 01h00 - 02h00 CET | TIPS.stat.M2.b |
| 02h00 - 03h00 CET | TIPS.stat.M2.c |
| 03h00 - 04h00 CET | TIPS.stat.M2.d |
| 04h00 - 05h00 CET | TIPS.stat.M2.e |
| 05h00 - 06h00 CET | TIPS.stat.M2.f |
| 06h00 - 07h00 CET | TIPS.stat.M2.g |
| 07h00 - 08h00 CET | TIPS.stat.M2.h |
| 08h00 - 09h00 CET | TIPS.stat.M2.i |
| 09h00 - 10h00 CET | TIPS.stat.M2.j |
| 10h00 - 11h00 CET | TIPS.stat.M2.k |
| 11h00 - 12h00 CET | TIPS.stat.M2.l |
| 12h00 - 13h00 CET | TIPS.stat.M2.m |
| 13h00 - 14h00 CET | TIPS.stat.M2.n |
| 14h00 - 15h00 CET | TIPS.stat.M2.o |
| 15h00 - 16h00 CET | TIPS.stat.M2.p |
| 16h00 - 17h00 CET | TIPS.stat.M2.q |
| 17h00 - 18h00 CET | TIPS.stat.M2.r |
| 18h00 - 19h00 CET | TIPS.stat.M2.s |
| 19h00 - 20h00 CET | TIPS.stat.M2.t |
| 20h00 - 21h00 CET | TIPS.stat.M2.u |
| 21h00 - 22h00 CET | TIPS.stat.M2.v |
| 22h00 - 23h00 CET | TIPS.stat.M2.w |
| 23h00 - 24h00 CET | TIPS.stat.M2.x |
| Duration of processing (IP settled) | |
| $\leq 0,5$ second | TIPS.stat.M3.a |
| $> 0,5$ second and ≤ 1 second | TIPS.stat.M3.b |
| > 1 second and ≤ 2 seconds | TIPS.stat.M3.c |
| > 2 seconds and ≤ 3 seconds | TIPS.stat.M3.d |
| > 3 seconds and ≤ 4 seconds | TIPS.stat.M3.e |
| > 4 seconds and ≤ 5 seconds | TIPS.stat.M3.f |
| > 5 seconds and ≤ 10 seconds | TIPS.stat.M3.g |
| > 10 seconds and ≤ 15 seconds | TIPS.stat.M3.h |
| > 15 seconds and ≤ 20 seconds | TIPS.stat.M3.i |
| > 20 seconds and ≤ 25 seconds | TIPS.stat.M3.j |

| Label | Indicator's reference |
|---------------------------------------|-----------------------|
| > 25 seconds | TIPS.stat.M3.k |
| Duration of processing (IP unsettled) | |
| ≤ 5 seconds | TIPS.stat.M4.a |
| > 5 seconds and ≤ 10 seconds | TIPS.stat.M4.b |
| > 10 seconds and ≤ 15 seconds | TIPS.stat.M4.c |
| > 15 seconds and ≤ 20 seconds | TIPS.stat.M4.d |
| > 20 seconds and ≤ 25 seconds | TIPS.stat.M4.e |
| > 25 seconds | TIPS.stat.M4.f |
| no confirmation after 25 sec | TIPS.stat.M4.g |
| Investigations | |
| [Number of Investigations] | TIPS.stat.M5.a |

4.3.5. List of National Transactions indicators for non-Euro currencies

The table below contains the exhaustive list of general National Transactions Indicators present in TIPS for non-Euro currencies (e.g. SEK). The detailed information about these measures is defined in paragraph [1.5.8.2 "National Transactions"](#).

| Label | Indicator's reference |
|---|--|
| Period (month or quarter) | |
| National transactions | |
| Transactions per country | |
| [Country code] | TIPS.stat.M6.[Country code] OR [empty] |
| Unsettled Transactions per country | |
| [Country code] | TIPS.stat.M7.[Country code] OR [empty] |
| Recall Request per country | |
| [Country code] | TIPS.stat.M8.[Country code] OR [empty] |
| Unsettled Transactions per reason code | |
| [Country code].[Reason code] ₁ ...[Country code].[Reason code] _m | TIPS.stat.M9.[Country code].[Reason code] ₁ ... TIPS.stat.M9.[Country code].[Reason code] _m |
| Recall Request per reason code | |
| [Country code].[Reason code] ₁ ...[Country code].[Reason code] _m | TIPS.stat.M10.[Country code].[Reason code] ₁ ... TIPS.stat.M10.[Country code].[Reason code] _m |
| Request for Recall per Country | |
| [Country code] | TIPS.stat.M11.[Country code] OR [empty] TIPS.stat.M11.[Country code] OR [empty] |
| Volume of national payment transactions | |
| [Country code].[Currency code] | TIPS.stat.M12.[Country code] |
| Value of national payment transactions | |
| [Country code].[Currency code] | TIPS.stat.M13.[Country code] |

4.4. Index of figures

| | |
|---|-----|
| Figure 1 – Scope of UDFS..... | 11 |
| Figure 2 – TIPS Connectivity..... | 15 |
| Figure 3 – Party reference data model..... | 25 |
| Figure 4 – Account structure and organisation..... | 27 |
| Figure 5 – Dynamic data model..... | 32 |
| Figure 6 – Instant Payment Transaction status transition diagram..... | 44 |
| Figure 7 – Single Instructing Party settlement model for Instant Payments..... | 46 |
| Figure 8 – SIP Instant Payment Transaction status transition diagram..... | 47 |
| Figure 9 – Positive Recall Response status diagram..... | 49 |
| Figure 10 – Inbound Liquidity Transfer status diagram..... | 51 |
| Figure 11 – Outbound Liquidity Transfer status diagram..... | 52 |
| Figure 12 – Intra-service Liquidity Transfer status diagram..... | 54 |
| Figure 13 – Interaction with RTGS System for Liquidity Transfers..... | 86 |
| Figure 14 – Closure and opening of the RTGS System..... | 87 |
| Figure 15 – RTGS System change of business date..... | 88 |
| Figure 16 - Snapshot generation and partial closure status..... | 90 |
| Figure 17 – Interaction between CRDM and TIPS..... | 94 |
| Figure 18 – Timeout parameters for SCT Inst..... | 97 |
| Figure 19 – Instant Payment transaction flow..... | 106 |
| Figure 20 – Instant Payment transaction missing/delayed Beneficiary-side answer flow..... | 115 |
| Figure 21 – Instant Payment transaction examples data constellation..... | 118 |
| Figure 22 – Successful Instant Payment transaction: FItoFICustomerCreditTransfer..... | 119 |
| Figure 23 – Successful Instant Payment transaction: reservation of funds..... | 120 |
| Figure 24 – Successful Instant Payment transaction: FItoFIPaymentStatusReport..... | 120 |
| Figure 25 – Successful Instant Payment transaction: settlement phase..... | 121 |
| Figure 26 – Successful Instant Payment transaction: FItoFICustomerCreditTransfer..... | 121 |
| Figure 27 – Successful Instant Payment transaction: reservation of funds..... | 122 |
| Figure 28 – Successful Instant Payment transaction: FItoFIPaymentStatusReport..... | 123 |
| Figure 29 – Successful Instant Payment transaction: settlement phase..... | 124 |
| Figure 30 – Successful Instant Payment transaction: FItoFICustomerCreditTransfer..... | 124 |
| Figure 31 – Successful Instant Payment transaction reservation of funds..... | 125 |
| Figure 32 – Successful Instant Payment transaction: FItoFIPaymentStatusReport..... | 126 |
| Figure 33 – Successful Instant Payment transaction: settlement phase..... | 127 |
| Figure 34 – Rejected Instant Payment transaction: FItoFICustomerCreditTransfer..... | 127 |
| Figure 35 – Rejected Instant Payment transaction: reservation of funds..... | 128 |
| Figure 36 – Rejected Instant Payment transaction: FItoFIStatusReport..... | 129 |
| Figure 37 – Rejected Instant Payment transaction: release of funds..... | 130 |
| Figure 38 – Successful Instant Payment transaction: FItoFICustomerCreditTransfer..... | 131 |
| Figure 39 – Successful Instant Payment transaction: reservation of funds..... | 131 |
| Figure 40 – Successful Instant Payment transaction: FItoFIPaymentStatusReport..... | 132 |
| Figure 41 – Successful Instant Payment transaction successful: settlement phase..... | 133 |
| Figure 42 – Headroom error: FItoFICustomerCreditTransfer..... | 134 |
| Figure 43 – Headroom error: transaction failed..... | 134 |
| Figure 44 – Headroom error: FItoFIPaymentStatusReport..... | 135 |
| Figure 45 – Blocked account error: FItoFICustomerCreditTransfer..... | 135 |
| Figure 46 – Blocked account error: transaction failed..... | 136 |
| Figure 47 – Blocked account error: FItoFIPaymentStatusReport..... | 136 |

| | |
|---|-----|
| Figure 48 – Beneficiary side timeout error: FItoFICustomerCreditTransfer..... | 137 |
| Figure 49 – Beneficiary side timeout error: reservation of funds..... | 137 |
| Figure 50 – Beneficiary side timeout error: FItoFIPaymentStatusReport | 138 |
| Figure 51 – Beneficiary side timeout error: release of funds..... | 138 |
| Figure 52 – Beneficiary side timeout error: FItoFIStatusReport..... | 139 |
| Figure 53 – Delayed Beneficiary-side answer: FItoFICustomerCreditTransfer..... | 140 |
| Figure 54 – Delayed Beneficiary-side answer: reservation of funds..... | 140 |
| Figure 55 – Delayed Beneficiary-side answer: release of funds..... | 141 |
| Figure 56 – Timeout answer: FItoFIPaymentStatusReport (Originator side)..... | 141 |
| Figure 57 – Timeout answer: FItoFIPaymentStatusReport (Beneficiary side) | 142 |
| Figure 58 – Delayed Beneficiary-side response: FItoFIPaymentStatusReport | 142 |
| Figure 59 – Delayed Beneficiary-side response: FItoFIPaymentStatusReport | 142 |
| Figure 60 – Instant Payment transaction flow for non-Euro currencies..... | 144 |
| Figure 61 – Instant Payment transaction missing/delayed Beneficiary-side answer flow (non-Euro currencies)..... | 153 |
| Figure 62 – Instant Payment transaction examples data constellation for non-Euro currencies..... | 156 |
| Figure 63 – Successful Instant Payment transaction: FItoFICustomerCreditTransfer | 157 |
| Figure 64 – Successful Instant Payment transaction: reservation of funds..... | 158 |
| Figure 65 – Successful Instant Payment transaction: FItoFIPaymentStatusReport | 158 |
| Figure 66 – Successful Instant Payment transaction: settlement phase..... | 159 |
| Figure 67 – Successful Instant Payment transaction: FItoFICustomerCreditTransfer | 160 |
| Figure 68 – Successful Instant Payment transaction: reservation of funds..... | 161 |
| Figure 69 – Successful Instant Payment transaction: FItoFIPaymentStatusReport | 161 |
| Figure 70 – Successful Instant Payment transaction: settlement phase..... | 162 |
| Figure 71 – Successful Instant Payment transaction: FItoFICustomerCreditTransfer | 163 |
| Figure 72 – Successful Instant Payment transaction: reservation of funds..... | 164 |
| Figure 73 – Successful Instant Payment transaction: FItoFIPaymentStatusReport | 164 |
| Figure 74 – Successful Instant Payment transaction: settlement phase..... | 165 |
| Figure 75 – Rejected Instant Payment transaction: FItoFICustomerCreditTransfer | 166 |
| Figure 76 – Rejected Instant Payment transaction: reservation of funds..... | 167 |
| Figure 77 – Rejected Instant Payment transaction: FItoFIStatusReport | 167 |
| Figure 78 – Rejected Instant Payment transaction: release of funds..... | 168 |
| Figure 79 – Headroom error: FItoFICustomerCreditTransfer..... | 169 |
| Figure 80 – Headroom error: transaction failed..... | 170 |
| Figure 81 – Headroom error: FItoFIPaymentStatusReport | 170 |
| Figure 82 – Blocked account error: FItoFICustomerCreditTransfer | 171 |
| Figure 83 – Blocked account error: transaction failed | 171 |
| Figure 84 – Blocked account error: FItoFIPaymentStatusReport..... | 172 |
| Figure 85 – Beneficiary side timeout error: FItoFICustomerCreditTransfer..... | 172 |
| Figure 86 – Beneficiary side timeout error: reservation of funds..... | 173 |
| Figure 87 – Beneficiary side timeout error: FItoFIPaymentStatusReport | 173 |
| Figure 88 – Beneficiary side timeout error: release of funds..... | 174 |
| Figure 89 – Beneficiary side timeout error: FItoFIStatusReport..... | 175 |
| Figure 90 – Delayed Beneficiary-side answer: FItoFICustomerCreditTransfer..... | 175 |
| Figure 91 – Delayed Beneficiary-side answer: reservation of funds..... | 176 |
| Figure 92 – Delayed Beneficiary-side answer: release of funds..... | 177 |
| Figure 93 – Timeout answer: FItoFIPaymentStatusReport (Originator side)..... | 177 |
| Figure 94 – Timeout answer: FItoFIPaymentStatusReport (Beneficiary side) | 178 |

| | |
|---|-----|
| Figure 95 – Delayed Beneficiary-side response: FItoFIPaymentStatusReport | 178 |
| Figure 96 – Delayed Beneficiary-side response: FItoFIPaymentStatusReport | 178 |
| Figure 97 – Instant Payment transaction flow for SIP settlement model | 180 |
| Figure 98 – Instant Payment transaction in Euro - SIP model - examples data constellation | 186 |
| Figure 99 – Instant Payment transaction in a non-Euro currency - SIP settlement model - examples data constellation | 187 |
| Figure 100 – Successful Instant Payment in Euro with SIP model: FItoFICustomerCreditTransfer | 188 |
| Figure 101 – Successful Instant Payment in Euro with SIP model: settlement phase..... | 189 |
| Figure 102 – Successful Instant Payment in Euro with SIP model: FItoFIPaymentStatusReport | 189 |
| Figure 103 – Successful Instant Payment in non-Euro currency with SIP: FItoFICustomerCreditTransfer | 190 |
| Figure 104 – Successful Instant Payment in non-Euro currency with SIP: settlement phase | 191 |
| Figure 105 – Successful Instant Payment in non-Euro currency with SIP: FItoFIPaymentStatusReport | 191 |
| Figure 106 – Successful Instant Payment in non-Euro currency with SIP: FItoFICustomerCreditTransfer | 192 |
| Figure 107 – Successful Instant Payment in non-Euro currency with SIP: settlement phase | 193 |
| Figure 108 – Successful Instant Payment in non-Euro currency with SIP: FItoFIPaymentStatusReport | 193 |
| Figure 109 – Successful Instant Payment in non-Euro currency with SIP: FItoFICustomerCreditTransfer | 194 |
| Figure 110 – Successful Instant Payment in non-Euro currency with SIP: settlement phase | 195 |
| Figure 111 – Successful Instant Payment in non-Euro currency with SIP: FItoFIPaymentStatusReport | 195 |
| Figure 112 – Headroom error: FItoFICustomerCreditTransfer | 196 |
| Figure 113 – Headroom error: transaction failed..... | 197 |
| Figure 114 – Headroom error: FItoFIPaymentStatusReport | 197 |
| Figure 115 – Blocked account error: FItoFICustomerCreditTransfer | 198 |
| Figure 116 – Blocked account error: transaction failed | 198 |
| Figure 117 – Blocked account error: FItoFIPaymentStatusReport..... | 199 |
| Figure 118 – Recall flow..... | 201 |
| Figure 119 – Recall examples: data constellation..... | 209 |
| Figure 120 – Recall successful scenario: positive response – FItoFIPaymentCancellationRequest..... | 210 |
| Figure 121 – Recall successful scenario: positive response – PaymentReturn..... | 211 |
| Figure 122 – Recall successful scenario: positive response – Recall Dataset..... | 211 |
| Figure 123 – Recall successful scenario: positive response – Settlement Process | 212 |
| Figure 124 – Recall successful scenario: negative response – FItoFIPaymentCancellationRequest..... | 213 |
| Figure 125 – Recall successful scenario: negative response – ResolutionOfInvestigation.... | 213 |
| Figure 126 – Recall unsuccessful scenario: Duplicate check failed – FItoFIPaymentCancellationRequest..... | 214 |
| Figure 127 – Recall unsuccessful scenario: Duplicate check failed – PaymentReturn | 215 |

| | |
|---|-----|
| Figure 128 – Recall unsuccessful scenario: Duplicate check failed – Duplicate submission . | 215 |
| Figure 129 – Recall unsuccessful scenario: Duplicate check failed – FIToFIPaymentStatusReport | 216 |
| Figure 130 – Successful request for Status Update on a Recall | 217 |
| Figure 131 – Recall successful scenario: positive response – FIToFIPaymentCancellationRequest..... | 218 |
| Figure 132 – Recall successful scenario: positive response – PaymentReturn..... | 219 |
| Figure 133 – Recall successful scenario: positive response – Recall Dataset..... | 220 |
| Figure 134 – Recall successful scenario: positive response – Settlement Process | 220 |
| Figure 135 – Investigation Flow | 222 |
| Figure 136 – Transaction status investigation examples: data constellation | 225 |
| Figure 137 – Successful FIToFIPaymentStatusRequest | 226 |
| Figure 138 – Successful FIToFIPaymentStatusReport | 227 |
| Figure 139 – Unsuccessful FIToFIPaymentStatusRequest..... | 227 |
| Figure 140 – Unsuccessful FIToFIPaymentStatusReport | 228 |
| Figure 141 – Successful FIToFIPaymentStatusRequest originated by an AS | 229 |
| Figure 142 – Successful FIToFIPaymentStatusReport forwarded to an AS | 229 |
| Figure 143 – Inbound Liquidity Transfer Order flow | 232 |
| Figure 144 – Inbound Liquidity Transfer Order examples: data constellation | 235 |
| Figure 145 – Successful Inbound Liquidity Transfer order: liquidity credit transfer | 236 |
| Figure 146 – Successful Inbound Liquidity Transfer order settlement | 236 |
| Figure 147 – Successful Inbound Liquidity Transfer order Receipt..... | 237 |
| Figure 148 – Successful Inbound Liquidity Transfer order credit notification | 237 |
| Figure 149 – Unsuccessful Inbound Liquidity Transfer order: Liquidity credit transfer | 238 |
| Figure 150 – Unsuccessful Inbound Liquidity Transfer order: duplicate submission | 238 |
| Figure 151 – Unsuccessful Inbound Liquidity Transfer order Receipt | 239 |
| Figure 152 – Outbound Liquidity Transfer Order flow | 241 |
| Figure 153 – Outbound Liquidity Transfer Order examples: data constellation..... | 247 |
| Figure 154 – Successful Outbound Liquidity Transfer order: Liquidity Credit Transfer | 248 |
| Figure 155 – Successful Outbound Liquidity Transfer order settlement | 249 |
| Figure 156 – Successful Outbound Liquidity Transfer order: Liquidity Credit Transfer | 249 |
| Figure 157 – Successful Outbound Liquidity Transfer order Receipt received by TIPS | 249 |
| Figure 158 – Successful Outbound Liquidity Transfer order Receipt sent by TIPS | 250 |
| Figure 159 – Successful Outbound Liquidity Transfer order debit notification..... | 250 |
| Figure 160 – Unsuccessful Outbound Liquidity Transfer order: Liquidity Credit Transfer | 251 |
| Figure 161 – Unsuccessful Outbound Liquidity Transfer order Receipt sent by TIPS | 251 |
| Figure 162 – Outbound Liquidity Transfer order: incoming message..... | 252 |
| Figure 163 – Outbound Liquidity Transfer order: settlement in TIPS..... | 253 |
| Figure 164 – Outbound Liquidity Transfer order: forwarding to the RTGS System..... | 253 |
| Figure 165 – Outbound Liquidity Transfer order: negative Receipt sent by the RTGS System | 253 |
| Figure 166 – Outbound Liquidity Transfer order: reverse settlement | 254 |
| Figure 167 – Outbound Liquidity Transfer order: negative Receipt sent by TIPS | 254 |
| Figure 168 – Outbound Liquidity Transfer: Missing RTGS System answer flow | 255 |
| Figure 169 – Intra-service Liquidity Transfer diagram..... | 257 |
| Figure 170 – Intra-service Liquidity Transfer examples: data constellation | 261 |
| Figure 171 – Successful intra-service Liquidity Transfer: LiquidityCreditTransfer | 262 |
| Figure 172 – Successful intra-system Liquidity Transfer settlement..... | 262 |
| Figure 173 – Positive intra-service Liquidity Transfer: Receipt..... | 263 |

| | |
|--|-----|
| Figure 174 – Intra-service Liquidity Transfer debit notification..... | 263 |
| Figure 175 – Intra-service Liquidity Transfer credit notification..... | 264 |
| Figure 176 – Unsuccessful intra-service Liquidity Transfer: LiquidityCreditTransfer..... | 264 |
| Figure 177 – Insufficient balance on the debited account..... | 265 |
| Figure 178 – Negative intra-service Liquidity Transfer: Receipt..... | 265 |
| Figure 179 – Floor and ceiling notification triggers..... | 266 |
| Figure 180 – Floor notification settlement..... | 267 |
| Figure 181 – Floor notification ReturnAccount..... | 267 |
| Figure 182 – Ceiling notification settlement..... | 268 |
| Figure 183 – Ceiling notification ReturnAccount..... | 269 |
| Figure 184 – Account Balance Status query flow..... | 274 |
| Figure 185 – Payment transaction status query flow..... | 277 |
| Figure 186 – Queries examples: data constellation..... | 279 |
| Figure 187 – Successful GetAccount..... | 280 |
| Figure 188 – Successful ReturnAccount..... | 280 |
| Figure 189 – Successful GetAccount..... | 281 |
| Figure 190 – Successful ReturnAccount..... | 282 |
| Figure 191 – Unsuccessful GetAccount..... | 282 |
| Figure 192 – Unsuccessful GetAccount: account retrieval failure..... | 282 |
| Figure 193 – Unsuccessful ReturnAccount..... | 283 |
| Figure 194 – Successful GetTransaction..... | 283 |
| Figure 195 – Successful ReturnTransaction..... | 284 |
| Figure 196 – Unsuccessful GetTransaction..... | 284 |
| Figure 197 – Unsuccessful GetTransaction: Payment Transaction retrieval failure..... | 285 |
| Figure 198 – Unsuccessful ReturnTransaction..... | 285 |
| Figure 199 – Statement of Account Turnover flow..... | 287 |
| Figure 200 – Statement of Account Turnover example: report subscription..... | 288 |
| Figure 201 – Statement of Account Turnover example: data constellation..... | 289 |
| Figure 202 – Statement of Account Turnover example: list of transactions..... | 290 |
| Figure 203 – Statement of Account Turnover example: BankToCustomerAccountReport.... | 291 |
| Figure 204 – Statement of Accounts flow..... | 293 |
| Figure 205 – Statement of Accounts example: report subscription (full mode)..... | 294 |
| Figure 206 – Statement of Accounts example: report subscription (delta mode)..... | 294 |
| Figure 207 – Statement of Accounts example: data constellation..... | 295 |
| Figure 208 – Statement of Accounts example: list of transactions (full mode)..... | 296 |
| Figure 209 – Statement of Accounts example: BankToCustomerStatement..... | 297 |
| Figure 210 – Statement of Accounts example: list of transaction (delta mode)..... | 298 |
| Figure 211 – Statement of Accounts example: scheduled frequency n.1..... | 299 |
| Figure 212 – Statement of Accounts example: scheduled frequency n.2..... | 299 |
| Figure 213 – Statement of Accounts example: scheduled frequency n.3..... | 300 |
| Figure 214 – Statement of Accounts example: scheduled frequency n.4..... | 300 |
| Figure 215 – Reference Data Messages flow..... | 303 |
| Figure 216 – Reference Data Management examples: data constellation..... | 309 |
| Figure 217 – Successful block of a TIPS Participant: PartyModificationRequest..... | 310 |
| Figure 218 – TIPS Participant blocked for debiting..... | 310 |
| Figure 219 – Successful block of a TIPS Participant: PartyStatusAdvice..... | 310 |
| Figure 220 – Successful block of an Ancillary System: PartyModificationRequest..... | 311 |
| Figure 221 – Ancillary System blocked for debiting..... | 311 |
| Figure 222 – Successful block of a TIPS Participant: PartyStatusAdvice..... | 312 |

| | |
|---|-----|
| Figure 223 – Successful unblock of a TIPS Participant: PartyModificationRequest | 312 |
| Figure 224 – TIPS Participant unblocked | 313 |
| Figure 225 – Successful unblock of a TIPS Participant: PartyStatusAdvice | 313 |
| Figure 226 – Unsuccessful block of a TIPS Participant: PartyModificationRequest | 313 |
| Figure 227 – Successful block of a TIPS Participant: PartyStatusAdvice | 314 |
| Figure 228 – Successful block of a CMB: AccountExcludedMandateMaintenanceRequest | 314 |
| Figure 229 – CMB blocked for both credit and debit..... | 315 |
| Figure 230 – Successful block of a CMB: AccountRequestAcknowledgement..... | 315 |
| Figure 231 – Successful unblock of an Account: AccountExcludedMandateMaintenanceRequest | 315 |
| Figure 232 – Account unblocked | 316 |
| Figure 233 – Successful unblock of an Account: AccountRequestAcknowledgement..... | 316 |
| Figure 234 – Unsuccessful block of a CMB: AccountExcludedMandateMaintenanceRequest | 317 |
| Figure 235 – Unsuccessful block of a CMB: AccountRequestRejection | 317 |
| Figure 236 – Successful decrease of a CMB Limit: ModifyLimit..... | 318 |
| Figure 237 – Successful decrease of a CMB Limit..... | 318 |
| Figure 238 – Successful decrease of a CMB Limit: Receipt..... | 318 |
| Figure 239 – Unsuccessful decrease of a CMB Limit: ModifyLimit | 319 |
| Figure 240 – Unsuccessful decrease of a CMB Limit: Receipt..... | 319 |

4.5. Index of tables

| | |
|---|----|
| Table 1 – TIPS U2A functions | 19 |
| Table 2 – Setup of Parties for TIPS..... | 21 |
| Table 3 – Party reference data | 25 |
| Table 4 – Instructing Party reference data | 26 |
| Table 5 – Account reference data | 29 |
| Table 6 – CMB reference data | 31 |
| Table 7 – Authorised Account User reference data | 31 |
| Table 8 – Payment Transaction data | 32 |
| Table 9 – Liquidity Transfer data..... | 34 |
| Table 10 – Cash Posting data | 35 |
| Table 11 – Cash Balance data..... | 36 |
| Table 12 – CMB Headroom data..... | 37 |
| Table 13 – RTGS Systems data | 37 |
| Table 14 – TIPS Payment transaction types..... | 40 |
| Table 15 – Reference data management functions available in TIPS | 56 |
| Table 16 – Raw data | 60 |
| Table 17 – Raw data for Billing..... | 61 |
| Table 18 - RTGS consumption file structure | 62 |
| Table 19 – Number of transactions per Amount..... | 66 |
| Table 20 – Number of transactions per timestamp | 67 |
| Table 21 – Number of settled transactions per duration of processing | 67 |
| Table 22 – Number of unsettled IP transactions per duration of processing | 68 |
| Table 23 – Number of investigation requests..... | 68 |
| Table 24 – Number of national IP transactions..... | 69 |
| Table 25 – Number of national Unsettled IP Transactions..... | 69 |
| Table 26 – Number of national Recall Requests | 70 |
| Table 27 – National Unsettled IP Transaction per Reason Code..... | 70 |
| Table 28 – National Recall Requests per Reason Code..... | 71 |
| Table 29 – National Requests for Recall..... | 71 |
| Table 30 – Number of cross-border IP transactions..... | 72 |
| Table 31 – Number of cross-border Unsettled IP Transactions..... | 73 |
| Table 32 – Number of cross-border Recall Requests | 73 |
| Table 33 – Cross-border Unsettled Transaction per Reason Code..... | 74 |
| Table 34 – Number of Cross-border Recall Requests per Reason code | 74 |
| Table 35 – Cross-Border Requests for Recall | 75 |
| Table 36 – Number of national settled payment transactions | 75 |
| Table 37 – Value of national settled payment transactions | 76 |
| Table 38 – Number of Cross-Border settled payment transactions | 76 |
| Table 39 – Value of Cross-Border settled payment transactions..... | 76 |
| Table 40 – Number of transactions in SEK per Amount | 77 |
| Table 41 – Number of transactions in SEK per timestamp..... | 78 |
| Table 42 – Number of settled transactions in SEK per duration of processing | 79 |
| Table 43 – Number of unsettled IP transactions in SEK per duration of processing..... | 80 |
| Table 44 – Number of investigation requests relevant to IP in SEK | 80 |
| Table 45 – Number of national IP transactions in SEK | 81 |
| Table 46 – Number of national Unsettled IP Transactions in SEK | 82 |

| | |
|--|-----|
| Table 47 – Number of national Recall Requests | 82 |
| Table 48 – National Unsettled IP Transaction in SEK per Reason Code..... | 82 |
| Table 49 – National Recall Requests per Reason Code..... | 83 |
| Table 50 – National Requests for Recall..... | 83 |
| Table 51 – Number of national settled payment transactions for non-Euro currencies..... | 84 |
| Table 52 – Value of national settled payment transactions for non-Euro currencies..... | 84 |
| Table 53 – System Parameters..... | 95 |
| Table 54 – Network services | 99 |
| Table 55 – Outbound routing..... | 102 |
| Table 56 – Instant Payment transaction steps..... | 107 |
| Table 57 – Instant Payment transaction missing/delayed Beneficiary-side answer steps..... | 116 |
| Table 58 – Instant Payment transaction steps for non-Euro currencies | 145 |
| Table 59 – Instant Payment transaction missing/delayed Beneficiary-side answer steps (non-Euro currencies) | 154 |
| Table 60 – Instant Payment transaction steps for SIP settlement model..... | 181 |
| Table 61 – Recall steps..... | 202 |
| Table 62 – Investigation steps..... | 223 |
| Table 63 – Inbound Liquidity Transfer Order steps..... | 233 |
| Table 64 – Outbound Liquidity Transfer Order steps | 242 |
| Table 65 – Outbound Liquidity Transfer: Missing RTGS answer steps..... | 255 |
| Table 66 – Intra-service Liquidity Transfer steps..... | 258 |
| Table 67 – Query permissions | 270 |
| Table 68 – Account Balance Status query steps | 275 |
| Table 69 – Report permissions and data scope | 285 |
| Table 70 – Statement of Account Turnover steps | 287 |
| Table 71 – Statement of Accounts steps..... | 293 |
| Table 72 – Report naming convention..... | 301 |
| Table 73 – Block/unblock TIPS Actor steps | 304 |
| Table 74 – Block/unblock account/CMB steps..... | 305 |
| Table 75 – Update of a CMB Limit steps | 307 |
| Table 76 – List of messages for SCT ^{Inst} scheme..... | 322 |
| Table 77 – List of messages for non-Euro schemes..... | 323 |
| Table 78 – Description of the fields for DS-03 Dataset vs pacs.002.001.10 | 326 |
| Table 79 – Description of the fields for DS-06 Dataset vs pacs.004.001.09 | 329 |
| Table 80 – Description of the fields for DS-02 Dataset vs pacs.008.001.08 | 333 |
| Table 81 – Status investigation Message EPC DS-07 vs pacs.028.001.03..... | 340 |
| Table 82 – Request for Status Update on a Recall | 341 |
| Table 83 – pacs.002.001.10 | 344 |
| Table 84 – pacs.008.001.08 | 347 |
| Table 85 – pacs.004.001.09 | 355 |
| Table 86 – Status investigation Message pacs.028.001.03..... | 360 |
| Table 87 – Request for Status Update on a Recall pacs.028.001.03..... | 361 |
| Table 88 – GetAccount (camt.003.001.06)..... | 363 |
| Table 89 – Account Balance and Status Query response | 364 |
| Table 90 – CMB Limit and Status Query response..... | 365 |
| Table 91 – Query response error..... | 366 |
| Table 92 – CMB Floor and Ceiling notification..... | 367 |
| Table 93 – Account Floor and Ceiling notification..... | 368 |
| Table 94 – GetTransaction (camt.005.001.07) | 368 |

| | |
|---|-----|
| Table 95 – ReturnTransaction (camt.006.001.07)..... | 369 |
| Table 96 – ReturnTransaction (camt.006.001.07) – error scenario..... | 371 |
| Table 97 – ModifyLimit (camt.011.001.07)..... | 372 |
| Table 98 – ReturnBusinessDayInformation (camt.019.001.07)..... | 373 |
| Table 99 – Receipt (camt.025.001.05)..... | 374 |
| Table 100 – Receipt (camt.025.001.04)..... | 375 |
| Table 101 – ResolutionOfInvestigation (camt.029.001.09)..... | 377 |
| Table 102 – Outbound and intra-service LiquidityCreditTransfer (camt.050.001.05)..... | 380 |
| Table 103 – Inbound and Outbound Pull LiquidityCreditTransfer (camt.050.001.05) – RTGS interaction scenarios..... | 381 |
| Table 104 – BankToCustomerAccountReport (camt.052.001.06)..... | 382 |
| Table 105 – BankToCustomerStatement (camt.053.001.06)..... | 383 |
| Table 106 – BankToCustomerStatement (camt.053.001.08) – General Ledger..... | 387 |
| Table 107 – BankToCustomerDebitCreditNotification (camt.054.001.06)..... | 388 |
| Table 108 – FIToFIPaymentCancellationRequest (camt.056.001.08)..... | 390 |
| Table 109 – camt.056.001.08..... | 393 |
| Table 110 – camt.029.001.09..... | 396 |
| Table 111 – AccountRequestAcknowledgement (acmt.010.001.02)..... | 399 |
| Table 112 – AccountRequestRejection (acmt.011.001.02)..... | 401 |
| Table 113 – AccountExcludedMandateMaintenanceRequest (acmt.015.001.02)..... | 402 |
| Table 114 – PartyStatusAdvice (reda.016.001.01)..... | 403 |
| Table 115 – PartyModificationRequest (reda.022.001.01)..... | 405 |

4.6. List of acronyms

| Item | Description |
|----------|---|
| 24/7/365 | 24-hour and seven-day around the year |
| A2A | Application-to-Application |
| AS | Ancillary System |
| BIC | Business Identifier Code |
| CAMT | Cash Management |
| CET | Central European Time |
| CMB | Credit Memorandum Balance |
| CRDM | Common Reference Data Management |
| DN | Distinguished Name |
| DS | Dataset |
| ECB | European Central Bank |
| EIDB | Enhanced Information Database |
| EPC | European Payments Council |
| ESMIG | Eurosystem Single Market Infrastructure Gateway |
| GL | General Ledger |
| GUI | Graphical User Interface (see U2A) |
| IBAN | International Bank Account Number |
| ILT | Inbound Liquidity Transfer |
| LeA | Legal Archiving |
| LRDM | Local Reference Data Management |
| NCB | National Central Bank |
| NRO | Non-Repudiation of Origin |
| NSP | Network Service Provider |
| OLT | Outbound Liquidity Transfer |
| PACS | Payments Clearing and Settlement |
| RTGS | Real Time Gross Settlement |
| SEPA | Single Euro Payments Area |
| SIP | Single Instructing Party |
| T2S | TARGET2-Securities |
| TIPS | TARGET Instant Payment Settlement |
| U2A | User-to-Application |
| UDFS | User Detailed Functional Specifications |
| UHB | User Handbook |

| Item | Description |
|------|-----------------------------|
| UR | User Requirement |
| URD | User Requirements Document |
| XML | Extensible Mark-up Language |

4.7. List of referenced documents

| | Title | Source |
|-----|--|--------|
| [1] | SEPA Instant Credit Transfer (SCT ^{Inst}) Scheme Rulebook, Version 1.1, 2023 | EPC |
| [2] | SEPA Instant Credit Transfer Scheme Inter-PSP Implementation Guidelines, Version V1.1, 2023 | EPC |
| [3] | TARGET Instant Payment Settlement User Requirements | ECB |
| [4] | TARGET Instant Payment Settlement User Handbook | 4CB |
| [5] | TIPS Connectivity Guide | 4CB |
| [6] | EPC087-22 / Version 3.0: EPC Guidance Document - Migration to the 2019 Version of the ISO 20022 Standard-based XML Messages | EPC |
| [7] | EPC053-23 / Version 1.1 – ERRATA to the 2023 version 1.1 of the SEPA Instant Credit Transfer Customer-to-PSP (C2PSP) and Inter-PSP Implementation Guidelines | EPC |