



target | T2S services

Target2-Securities

User Handbook

R2024.JUN

22 February 2024

Disclaimer

All rights reserved. Reproduction for educational and non-commercial purposes is permitted provided that the source is acknowledged.

Table of Contents

Disclaimer	2
Terms and Abbreviations	23
1 Introduction	26
1.1 Overview of the User Handbook	26
1.1.1 UHB Methodology	26
1.1.2 UHB Structure	29
1.2 Overview of the Graphical User Interface for T2S GUI	31
1.2.1 Setup and Login Procedures	31
1.2.2 GUI Structure	32
1.2.2.1 Menu Structure.....	32
1.2.2.2 Screen Structure.....	33
1.2.2.3 Screen Types.....	35
1.2.2.4 Field Types and Properties.....	37
1.2.2.5 Common Buttons and Icons.....	43
1.2.3 Validation	49
1.2.4 Communication Network and Services	54
1.2.5 User Administration	54
1.2.6 Security and Certification Service	54
1.2.7 Online Help	54
1.3 Overview of the Graphical User Interface for CoCo GUI	55
1.3.1 Setup and Login Procedures	56
1.3.2 GUI Structure	57
1.3.2.1 Menu Structure.....	58
1.3.2.2 Screen Structure.....	58
1.3.2.3 Screen Types.....	60
1.3.2.4 Field Types and Properties.....	61
1.3.2.5 Common Buttons and Icons.....	68
1.3.3 Validation	73
1.3.4 Communication Network and Services	75
1.3.5 User Administration	75
1.3.6 Security and Certification Services	76
1.3.7 Online Help	76
2 Screen Reference Part	77
2.1 General	77
2.2 Securities	82
2.2.1 Securities Account	82
2.2.1.1 Securities Positions - Search/List Screen.....	82

2.2.1.2	Securities Position - Details Screen	82
2.2.1.3	Securities Postings - Search/List Screen	82
2.2.1.4	Securities Restriction Details - Search/List Screen	86
2.2.2	Settlement.....	90
2.2.2.1	Allegation Instructions - Search/List Screen.....	90
2.2.2.2	Allegation Instruction - Details Screen	94
2.2.2.3	Amendment Securities Instruction - Details Screen	98
2.2.2.4	Amendment Securities Instruction - New Screen	103
2.2.2.5	Cancellation Securities Instruction - Details Screen	113
2.2.2.6	Cancellation Securities Instruction - New Screen.....	117
2.2.2.7	Data Changes - Search/List Screen	122
2.2.2.8	Data Change - Details Screen	122
2.2.2.9	Hold/Release Instruction - Details Screen.....	122
2.2.2.10	Hold/Release Instruction - New Screen.....	126
2.2.2.11	Intra-Position Movements - Search/List Screen	137
2.2.2.12	Intra-Position Movement - Details Screen	144
2.2.2.13	Intra-Position Movement - New Screen.....	151
2.2.2.14	Maintenance Securities Instructions - Search/List Screen	164
2.2.2.15	Securities Positions - Search/List Screen.....	169
2.2.2.16	Securities Position - Details Screen	174
2.2.2.17	Settlement Instructions - Search/List Screen	177
2.2.2.18	Settlement Instruction - Details Screen	192
2.2.2.19	Settlement Instruction - New Screen	211
2.2.2.20	Status History - Details Screen.....	267
2.2.2.21	Insolvency procedure Settlement Instructions - Search/List Screen	270
2.2.2.22	Links Preventing Settlement - List Screen.....	277
2.2.2.23	Penalty - Search/List Screen	279
2.2.2.24	Penalty - Details Screen	291
2.2.2.25	Monthly Net Penalty Amounts - Search/List Screen.....	310
2.2.2.26	Penalty - Removal Screen.....	315
2.2.2.27	Penalty - Re-allocation Screen	318
2.2.2.28	Penalty - Switch Screen	322
2.3	Cash	324
2.3.1	Cash Account.....	324
2.3.1.1	Cash Forecasts - Search/List Screen.....	324
2.3.1.2	Cash Forecast - Details Screen.....	332
2.3.1.3	Cash Restriction Details - Search/List Screen.....	338
2.3.1.4	Collateral Values of a Security - Search/List Screen	341
2.3.1.5	Collateral Values per T2S Dedicated Cash Account and Security - Search/List Screen.....	345
2.3.1.6	Limits - Search/list Screen.....	348

2.3.1.7	Limit - New/Edit Screen	348
2.3.1.8	Limit Utilisation - Search/List Screen	349
2.3.1.9	Limit Utilisation Journal - Search/List Screen	353
2.3.1.10	T2S DCA Balances - Search/List Screen	358
2.3.1.11	T2S DCA Balance - Details Screen	362
2.3.1.12	T2S DCA Postings - Search/List Screen	364
2.3.1.13	Total Collateral Values per T2S Dedicated Cash Account - Search/ List Screen	370
2.3.2	Liquidity	374
2.3.2.1	Data Changes - Search/List Screen	374
2.3.2.2	Data Change - Details Screen	374
2.3.2.3	Immediate Liquidity Transfers - Search/List Screen	374
2.3.2.4	Immediate Liquidity Transfer - Details Screen.....	382
2.3.2.5	Immediate Liquidity Transfer - New Screen	387
2.3.2.6	Outstanding Auto-Collateralisation Credits - Search/List Screen ..	393
2.3.2.7	Overall Liquidity - Search/List Screen	397
2.3.2.8	Standing/Predefined Liquidity Transfer Orders - Search/List Screen	401
2.3.2.9	Standing/Predefined Liquidity Transfer Order - Details Screen.....	401
2.3.2.10	Standing/Predefined Liquidity Transfer Order - New/Edit Screen .	401
2.3.2.11	Standing/Predefined Liquidity Transfer Order Link Sets - Search/List Screen	401
2.3.2.12	Standing/Predefined Liquidity Transfer Order Link Set - Details Screen	401
2.3.2.13	Standing/Predefined Liquidity Transfer Order Link Set - New/Edit Screen	401
2.3.2.14	Total Amount of Standing/Predefined Liquidity Transfer Orders - Search/List Screen	401
2.3.3	Settlement.....	405
2.3.3.1	Amendment Cash Instruction - Details Screen.....	405
2.3.3.2	Amendment Cash Instruction - New Screen	410
2.3.3.3	Cancellation Cash Instruction - Details Screen	417
2.3.3.4	Cancellation Cash Instruction - New Screen	420
2.3.3.5	Intra-Balance Movements - Search/List Screen	423
2.3.3.6	Intra-Balance Movement - Details Screen	430
2.3.3.7	Intra-Balance Movement - New Screen.....	437
2.3.3.8	Maintenance Cash Instructions - Search/List Screen.....	448
2.3.3.9	Status History - Details Screen.....	452
2.4	Services	452
2.4.1	Additional Services.....	452
2.4.1.1	Available Reports - Search/List Screen	452
2.4.1.2	Available Report - Details Screen.....	457

2.4.1.3	Available Report - Current Settlement Day Cash Information (Following Settlement Day Cash Forecast) Report - Details Screen..	459
2.4.1.4	Available Report - Statement of Accounts - Details Screen	464
2.4.1.5	Available Report - Statement of Executed Amendment Instructions for Intra-Balance Movements - Details Screen	467
2.4.1.6	Available Report - Statement of Executed Amendment Instructions for Intra-Position Movements and Settlement Instructions - Details Screen	472
2.4.1.7	Available Report - Statement of Executed Cancellation Instructions for Intra-Balance Movements - Details Screen	481
2.4.1.8	Available Report - Statement of Executed Cancellation Instructions for Intra-Position Movements and Settlement Instructions - Details Screen	485
2.4.1.9	Available Report - Statement of Holdings - Details Screen	493
2.4.1.10	Available Report - Statement of Pending Amendment Instructions for Intra-Balance Movements - Details Screen.....	498
2.4.1.11	Available Report - Statement of Pending Amendment Instructions for Intra-Position Movements and Settlement Instructions - Details Screen	503
2.4.1.12	Available Report - Statement of Pending Cancellation Instructions for Intra-Balance Movements - Details Screen.....	512
2.4.1.13	Available Report - Statement of Pending Cancellation Instructions for Intra-Position Movements and Settlement Instructions - Details Screen	516
2.4.1.14	Available Report - Statement of Pending Instructions - Details Screen	524
2.4.1.15	Available Report - Statement of Pending Intra-Balance Movements - Details Screen.....	533
2.4.1.16	Available Report - Statement of Pending Intra-Position Movements - Details Screen.....	538
2.4.1.17	Available Report - Statement of Settled Intra-Balance Movements - Details Screen.....	543
2.4.1.18	Available Report - Statement of Settled Intra-Position Movements - Details Screen.....	548
2.4.1.19	Available Report - Statement of Settlement Allegements - Details Screen	551
2.4.1.20	Available Report - Statement of Transactions - Details Screen	564
2.4.1.21	Available Report – Daily Penalty List – Details Screen	574
2.4.1.22	Available Report – List of Modified Penalties - Details Screen.....	588
2.4.1.23	Available Report – Monthly Aggregated Amounts – Details Screen	603
2.4.1.24	Data Changes - Search/List Screen	608

2.4.1.25	Data Change - Details Screen	612
2.4.2	Communication	617
2.4.2.1	Broadcast - Search/List Screen	617
2.4.2.2	Broadcast - Details Screen	620
2.4.2.3	Broadcast - New Screen	622
2.4.2.4	Inbound Files - Search/List Screen	623
2.4.2.5	Inbound File - Details Screen	626
2.4.2.6	Inbound Messages - Search/List Screen	629
2.4.2.7	Inbound Message - Details Screen	636
2.4.2.8	Outbound Files - Search/List Screen	641
2.4.2.9	Outbound File - Details Screen	644
2.4.2.10	Outbound Messages - Search/List Screen	646
2.4.2.11	Outbound Message - Details Screen	654
2.4.2.12	Resend Communication Screen	658
2.4.3	Revisions	662
2.4.3.1	Revisions/Audit Trail - List Screen	662
2.5	Monitoring	663
2.5.1	Monitoring	663
2.5.1.1	Securities Positions - Search/List Screen	663
2.5.1.2	Securities Position - Details Screen	663
2.5.1.3	T2S DCA Balances - Search/List Screen	664
2.5.1.4	T2S DCA Balance - Details Screen	664
2.6	Billing	664
2.6.1	Invoice Data	664
2.6.1.1	Invoice Data – Search/List screen	664
2.6.1.2	Invoice Data – Details screen	667
2.6.1.3	Itemised Invoice Data – Search/List screen	671
2.6.1.4	Itemised Invoice Data – Details screen	674
2.6.2	Manual Corrections	678
2.6.2.1	Manual Corrections – Search/List screen	678
2.6.2.2	Manual Correction – Details screen	681
2.6.2.3	Manual Correction – New/Edit screen	683
2.6.3	PDF Invoice	691
2.6.3.1	PDF Invoice – Search/List screen	691
2.6.4	Services	694
2.6.4.1	Outbound Messages – Search/List screen	694
2.6.4.2	Outbound Messages – Details screen	697
2.7	Business Day Management	700
2.7.1	Settlement Day	700
2.7.1.1	Settlement Day - Search/List Screen	700
2.7.2	Calendar	702

2.7.2.1	Calendar - Details Screen	702
3	User Instructions Part	705
3.1	General.....	705
3.2	Communication.....	706
3.2.1	Usage of Broadcasts	706
3.2.1.1	Create a New Broadcast	706
3.2.1.2	View a Broadcast.....	707
3.2.2	Monitoring of Communication.....	708
3.2.2.1	Resend Communication	708
3.2.2.2	View Inbound Communication.....	709
3.2.2.3	View Outbound Communication	710
3.3	Liquidity Transfers.....	712
3.3.1	Creation of a New Immediate Liquidity Transfer Order.....	712
3.3.1.1	Copy an Immediate Liquidity Transfer Order.....	712
3.4	Cash and Settlement Monitoring.....	714
3.4.1	Monitoring of Cash, Collateral and Limits Situation.....	714
3.4.1.1	View Cash Balances Details and Related Postings	714
3.4.1.2	View Cash Balances Details and Related Restrictions	715
3.4.1.3	View Immediate Liquidity Transfer Order Details	716
3.4.1.4	View Overall Liquidity	718
3.4.1.5	Reimburse an Outstanding Intraday Credit	720
3.4.2	Monitoring of Securities Positions.....	721
3.4.2.1	View Current Securities Positions and Related Postings	722
3.4.2.2	View Current Securities Positions and Related Restrictions	723
3.4.2.3	View Historic Securities Positions for a Specific Date	724
3.4.2.4	View Historic Securities Positions for a Specific Period	725
3.5	Settlement Instructions	726
3.5.1	Creation of a New Settlement Instruction.....	726
3.5.1.1	Enter a Settlement Instruction	727
3.5.1.2	Copy a Settlement Instruction	731
3.5.1.3	Respond to an Allegement Instruction.....	737
3.5.1.4	View Settlement Instruction Details	742
3.5.1.5	View Allegement Settlement Instruction Details	743
3.5.2	Creation of a New Amendment Instruction for a Settlement Instruction	744
3.5.2.1	Add a Link for a Settlement Instruction.....	744
3.5.2.2	Amend the Partial Settlement Indicator for a Settlement Instruction	747
3.5.2.3	Amend the Priority for a Settlement Instruction	748
3.5.2.4	Remove a Link for a Settlement Instruction.....	750

3.5.2.5	View Amendment Instruction for a Settlement Instruction Details	752
3.5.3	Creation of a New Hold/Release Instruction for a Settlement Instruction	754
3.5.3.1	Put a Settlement Instruction on Party Hold	754
3.5.3.2	Put a Settlement Instruction on CSD Hold	756
3.5.3.3	Release a Settlement Instruction from Party Hold	758
3.5.3.4	Partially Release a Settlement Instruction from Party Hold	759
3.5.3.5	Release a Settlement Instruction from CSD Hold	761
3.5.3.6	Release a Settlement Instruction from CoSD Hold	763
3.5.3.7	Release a Settlement Instruction from CSD Validation Hold	765
3.5.3.8	View Hold/Release Instruction Details	766
3.5.4	Creation of a New Cancellation Instruction for a Settlement Instruction	768
3.5.4.1	Cancel a Settlement Instruction	768
3.5.4.2	View Cancellation Instruction for a Settlement Instruction Details	770
3.5.4.3	View Alleged Cancellation Instructions	771
3.5.5	Monitoring of the Lifecycle of a Settlement Instruction	773
3.5.5.1	View Settlement Instruction Status History	773
3.5.5.2	View SF1/SF2 timestamps of Settlement Instructions in case of Insolvency situation	774
3.5.6	View the list of links data preventing settlement of a settlement instruction	775
3.5.7	Monitoring of Penalties	776
3.5.7.1	View the Individual Penalty Details	776
3.5.7.2	Modification of existing penalties	778
3.5.7.3	View List of Penalties	783
3.5.7.4	View monthly aggregated net amounts of penalties	784
3.6	Settlement Restrictions	786
3.6.1	Creation of a New Settlement Restriction on Securities	786
3.6.1.1	Enter a Settlement Restriction on Securities	786
3.6.1.2	Copy a Settlement Restriction on Securities	788
3.6.1.3	View Settlement Restriction on Securities Details	791
3.6.2	Creation of a New Settlement Restriction on Cash	792
3.6.2.1	Enter a Settlement Restriction on Cash	792
3.6.2.2	Copy a Settlement Restriction on Cash	794
3.6.2.3	View Settlement Restriction on Cash Details	797
3.6.3	Creation of a New Amendment Instruction for a Settlement Restriction on Securities	798
3.6.3.1	Add a Link for a Settlement Restriction on Securities	798
3.6.3.2	Amend the Priority for a Settlement Restriction on Securities	801
3.6.3.3	Remove a Link for a Settlement Restriction on Securities	803

3.6.3.4	View Amendment Instruction for a Settlement Restriction on Securities Details.....	805
3.6.4	Creation of a New Amendment Instruction for a Settlement Restriction on Cash.....	806
3.6.4.1	Add a Link for a Settlement Restriction on Cash.....	807
3.6.4.2	Amend the Priority for a Settlement Restriction on Cash	809
3.6.4.3	Remove a Link for a Settlement Restriction on Cash.....	811
3.6.4.4	View Amendment Instruction for a Settlement Restriction on Cash Details	813
3.6.5	Creation of a New Cancellation Instruction for a Settlement Restriction on Securities	814
3.6.5.1	Cancel a Settlement Restriction on Securities	814
3.6.5.2	View Cancellation Instruction for a Settlement Restriction on Securities Details.....	816
3.6.6	Creation of a New Cancellation Instruction for a Settlement Restriction on Cash	818
3.6.6.1	Cancel a Settlement Restriction on Cash.....	818
3.6.6.2	View Cancellation Instruction for a Settlement Restriction on Cash Details	819
3.6.7	View the list of links data preventing settlement of a settlement restriction on securities	821
3.6.8	View the list of links data preventing settlement of a settlement restriction on cash	822
3.7	Billing Data	823
3.7.1	Invoice Data Query.....	823
3.7.1.1	Querying Invoice Data	823
3.7.2	Querying Itemised Invoice Data.....	824
3.7.3	Querying PDF Invoice.....	825
3.8	Configuring of a Manual Correction.....	826
3.8.1	Create a New Manual Correction.....	826
3.8.2	Create a New Template Correction (CB).....	828
3.8.3	Create a New Manual Correction (CB)	830
3.8.4	Create a New Manual Correction without propagation (ECB)	832
3.8.5	Propagation of a Manual Correction to one Participant (ECB).....	835
3.8.6	Propagation of a Manual Correction to all Participants (ECB)	837
4	Trouble Management System Part.....	840
4.1	General.....	840
4.2	Screen Reference Part.....	843
4.2.1	Trouble Case – Search/List Screen.....	843
4.2.2	Trouble Case - Details Screen	849

4.2.3	Trouble Case - Export Screen.....	855
4.3	User Instructions Part.....	861
4.3.1	Monitoring of a Trouble Case	861
4.3.1.1	View Trouble Case	862
4.3.1.2	Execute a Report.....	862
5	Statistical Information Part	865
5.1	Introduction	865
5.1.1	Purpose of the document.....	865
5.1.1.1	UHB Methodology	865
5.1.1.2	UHB Structure	866
5.1.2	Set-up and Login.....	867
5.1.2.1	GUI Access.....	867
5.1.2.2	Technical Requirements	867
5.2	Introduction to the Data Warehouse	867
5.2.1	Overview	867
5.2.2	Process of the Data Warehouse	869
5.3	First steps & basics	870
5.3.1	Access to the DWH	870
5.3.2	Navigating in the DWH GUI – toolbar Global application bar	871
5.3.2.1	Open Menu.....	871
5.3.2.2	Welcome menu.....	871
5.3.2.3	Data Warehouse icon	872
5.3.2.4	Navigate between different views View Switcher	872
5.3.2.5	More icon.....	873
5.3.2.6	Set Notifications.....	874
5.3.2.7	Search content	881
5.3.2.8	Notification.....	882
5.3.2.9	Personal menu	884
5.3.2.10	Help menu	911
5.3.3	Navigating in the DWH GUI – menu.....	913
5.3.3.1	Target services logo	914
5.3.3.2	Home icon	914
5.3.3.3	Search function.....	916
5.3.3.4	System information.....	917
5.3.3.5	Recent	918
5.3.3.6	New	920
5.3.4	Personal Folders.....	920
5.3.4.1	Team content.....	920
5.3.4.2	My content	923
5.3.4.3	Add a new folder.....	923

5.3.4.4	Sort the content	924
5.3.4.5	Filter the content.....	925
5.4	Working with reports	925
5.4.1	Copy, save and export.....	925
5.4.1.1	Copy a report.....	926
5.4.1.2	Creating a report view	927
5.4.1.3	Saving a report output	932
5.4.1.4	Exporting a report to a local folder.....	933
5.4.2	Running reports	935
5.4.2.1	Run a report step-by-step.....	936
5.4.2.2	Delivery.....	943
5.4.3	Scheduling reports	953
5.4.3.1	Scheduling the report for a specific time	953
5.4.3.2	Scheduling the report for a specific DWH event.....	957
5.4.3.3	Check the schedule of your report.....	963
5.5	Predefined reports	964
5.5.1	T2S Cash account (SCT)	964
5.5.1.1	SCT01 – Finalised matched instructions	964
5.5.1.2	SCT02 – Detailed matched settlement instructions.....	967
5.5.1.3	SCT03 – Follow up by time slot of settlement activity	973
5.5.1.4	SCT04 – Comparison of settlement activity between two time periods	979
5.5.1.5	SCT05 – Follow-up by time slot of cash postings.....	985
5.5.2	T2S Securities account (SST)	989
5.5.2.1	SST01 – Finalised matched instructions	989
5.5.2.2	SST02 – Detailed finalised matched instructions	995
5.5.2.3	SST03 – Follow-up by time slot of securities postings	1002
5.5.3	T2S Instructions (INX).....	1006
5.5.3.1	INX01 – Individual settlement detailed report.....	1006
5.5.3.2	INX02 – Multi-criteria search of a set of settlement instructions..	1022
5.5.3.3	INX03 – Individual restriction detailed report.....	1042
5.5.3.4	INX04 – Multi-criteria search of a set of settlement restrictions ..	1049
5.5.3.5	INX05 – Liquidity transfers	1061
5.5.3.6	INX06 – Multi-criteria search of a set of business cancellations .	1069
5.5.3.7	INX07 – Multi-criteria search of a set of amendment instructions	1077
5.5.3.8	INX08 – Multi-criteria search of a set of hold and release instructions	1087
5.5.3.9	INX09 – Multi-criteria search of a set of liquidity transfers	1093
5.5.4	T2S Restrictions (RES).....	1104
5.5.4.1	RES01 – Detailed cash restrictions	1104
5.5.4.2	RES02 – Detailed securities restrictions	1109

5.5.5	T2S Credit line (CMB)	1114
5.5.5.1	CMB01 – Journaling of limit utilisations of primary CMB	1114
5.5.6	T2S Collateral instructions (COL)	1117
5.5.6.1	COL01 – Follow-up by time slot of settled collateralisation instructions.....	1117
5.5.7	Technical instructions (RAL)	1121
5.5.7.1	RAL01 – Detailed realignment and other technical instructions ..	1121
	Index	1128
6	Annex	1130
6.1	Indication of Usage	1130
6.1.1	Reader's Guide	1130
6.1.2	Usage Indication	1130
6.2	Sitemap for T2S GUI	1143
6.2.1	Reader's Guide	1143
6.2.2	Securities	1147
6.2.2.1	Securities Account	1147
6.2.2.2	Settlement	1148
6.2.2.3	Settlement II	1149
6.2.3	Cash	1150
6.2.3.1	Cash Account	1150
6.2.3.2	Liquidity	1151
6.2.3.3	Liquidity II	1152
6.2.3.4	Settlement	1153
6.2.4	Services	1154
6.2.4.1	Additional Services	1154
6.2.4.2	Additional Services II	1155
6.2.4.3	Additional Services III	1156
6.2.4.4	Additional Services IV	1157
6.2.4.5	Additional Services V	1158
6.2.4.6	Additional Services VI.....	1159
6.2.4.7	Communication.....	1160
6.2.4.8	Communication II.....	1161
6.2.4.9	Communication III.....	1162
6.2.5	Monitoring.....	1163
6.2.5.1	Monitoring	1163
6.2.6	Business Day Management.....	1164
6.2.6.1	Business Day Management.....	1164
6.3	Sitemap for CoCo GUI	1165
6.3.1	Billing	1166
6.3.1.1	Invoice Data	1166

6.3.1.2	Itemised Invoice Data	1167
6.3.1.3	Manual Correction	1168
6.3.1.4	PDF Invoice	1168
6.3.2	Business Day Management.....	1169
6.3.2.1	Settlement Day	1169
6.3.2.2	Calender	1169
6.4	List of Privileges	1170
6.4.1	Reader's Guide	1170
6.4.2	Privilege Classes for GUI Screens	1170
6.4.3	Privileges for GUI Screens for CoCos.....	1194
6.4.3.1	BILL – Invoice data – Search/list screen	1194
6.4.3.2	BILL - Invoice Data – Details Screens	1194
6.4.3.3	BILL – Itemised Invoice Data - Search/List Screen	1194
6.4.3.4	BILL – Itemised Invoice Data - Details Screen	1195
6.4.3.5	BILL – Manual Corrections – Search/List Screen.....	1195
6.4.3.6	BILL – Manual Corrections – Details Screen.....	1195
6.4.3.7	BILL – Manual Corrections – New/Edit Screen	1195
6.4.3.8	BILL – PDF Invoice – Search/List Screen	1196
6.4.4	Privileges for T2S GUI Screens	1196
6.4.4.1	Allegation Instruction - Details Screen	1196
6.4.4.2	Allegation Instructions - Search/List Screen.....	1196
6.4.4.3	Amendment Cash Instruction - Details Screen.....	1196
6.4.4.4	Amendment Cash Instruction - New Screen	1197
6.4.4.5	Amendment Securities Instruction - Details Screen	1197
6.4.4.6	Amendment Securities Instruction - New Screen	1197
6.4.4.7	Available Report - Current Settlement Day Cash Information (Following Settlement Day Cash Forecast) Report - Details Screen	1198
6.4.4.8	Available Report - Details Screen.....	1198
6.4.4.9	Available Report - Statement of Accounts - Details Screen	1199
6.4.4.10	Available Report - Statement of Executed Amendment Instructions for Intra-Balance Movements - Details Screen	1199
6.4.4.11	Available Report - Statement of Executed Amendment Instructions for Intra-Position Movements and Settlement Instructions - Details Screen	1199
6.4.4.12	Available Report - Statement of Executed Cancellation Instructions for Intra-Balance Movements - Details Screen	1200
6.4.4.13	Available Report - Statement of Executed Cancellation Instructions for Intra-Position Movements and Settlement Instructions - Details Screen	1200
6.4.4.14	Available Report - Statement of Holdings - Details Screen	1200
6.4.4.15	Available Report - Statement of Pending Amendment Instructions for Intra-Balance Movements - Details Screen.....	1201

6.4.4.16	Available Report - Statement of Pending Amendment Instructions for Intra-Position Movements and Settlement Instructions - Details Screen	1201
6.4.4.17	Available Report - Statement of Pending Cancellation Instructions for Intra-Balance Movements - Details Screen.....	1201
6.4.4.18	Available Report - Statement of Pending Cancellation Instructions for Intra-Position Movements and Settlement Instructions - Details Screen	1202
6.4.4.19	Available Report - Statement of Pending Instructions - Details Screen	1202
6.4.4.20	Available Report - Statement of Pending Intra-Balance Movements - Details Screen	1202
6.4.4.21	Available Report - Statement of Pending Intra-Position Movements - Details Screen	1203
6.4.4.22	Available Report - Statement of Settled Intra-Balance Movements - Details Screen.....	1203
6.4.4.23	Available Report - Statement of Settled Intra-Position Movements - Details Screen.....	1203
6.4.4.24	Available Report - Statement of Settlement Allegements - Details Screen	1203
6.4.4.25	Available Report - Statement of Transactions - Details Screen ..	1204
6.4.4.26	Available Reports - Search/List Screen	1204
6.4.4.27	Available Reports – Daily Penalty List – Details Screen	1204
6.4.4.28	Available Reports – List of Modified Penalties – Details Screen .	1205
6.4.4.29	Available Reports – Monthly Aggregated Amounts – Details Screen	1205
6.4.4.30	Broadcast - Details Screen	1205
6.4.4.31	Broadcast - New Screen.....	1205
6.4.4.32	Broadcasts - Search/List Screen	1206
6.4.4.33	Calender - Details Screen	1206
6.4.4.34	Cancellation Cash Instruction - Details Screen	1206
6.4.4.35	Cancellation Cash Instruction - New Screen	1207
6.4.4.36	Cancellation Securities Instruction - Details Screen.....	1207
6.4.4.37	Cancellation Securities Instruction - New Screen.....	1207
6.4.4.38	Cash Forecast - Details Screen.....	1208
6.4.4.39	Cash Forecasts - Search/List Screen	1208
6.4.4.40	Cash Restriction Details - Search/List Screen.....	1208
6.4.4.41	Collateral Value of a Security - Search/List Screen.....	1209
6.4.4.42	Collateral Value per T2S Dedicated Cash Account and Security - Search/List Screen.....	1209
6.4.4.43	Settlement Day - Search/List Screen	1209
6.4.4.44	Data Change - Details Screen	1210

6.4.4.45	Data Changes - Search/List Screen	1210
6.4.4.46	Hold/Release Instruction - Details Screen	1211
6.4.4.47	Hold/Release Instruction - New Screen	1211
6.4.4.48	Immediate Liquidity Transfer Order - New Screen	1213
6.4.4.49	Immediate Liquidity Transfer Order- Details Screen	1213
6.4.4.50	Immediate Liquidity Transfer Orders - Search/List Screen	1214
6.4.4.51	Inbound File - Details Screen	1214
6.4.4.52	Inbound Files - Search/List Screen	1214
6.4.4.53	Inbound Message - Details Screen	1214
6.4.4.54	Inbound Messages - Search/List Screen	1215
6.4.4.55	Insolvency procedure Settlement Instructions - Search/List Screen	1215
6.4.4.56	Intra-Balance Movement - Details Screen	1215
6.4.4.57	Intra-Balance Movement - New Screen	1216
6.4.4.58	Intra-Balance Movements - Search/List Screen	1216
6.4.4.59	Intra-Position Movement - Details Screen	1217
6.4.4.60	Intra-Position Movement - New Screen	1217
6.4.4.61	Intra-Position Movements - Search/List Screen	1218
6.4.4.62	Limit Utilisation - Search/List Screen	1218
6.4.4.63	Limit Utilisation Journal - Search/List Screen	1218
6.4.4.64	Maintenance Cash Instructions – Search/List Screen	1218
6.4.4.65	Maintenance Securities Instructions – Search/List Screen	1219
6.4.4.66	Outbound File - Details Screen	1220
6.4.4.67	Outbound Files - Search/List Screen	1220
6.4.4.68	Outbound Message - Details Screen	1221
6.4.4.69	Outbound Messages - Search/List Screen	1221
6.4.4.70	Outstanding Auto-Collateralisation Credits - Search/List Screen	1222
6.4.4.71	Overall Liquidity - Search/List Screen	1222
6.4.4.72	Penalty – Search/List Screen	1222
6.4.4.73	Penalty – Details Screen	1223
6.4.4.74	Monthly Net Penalty Amounts – Search/List Screen	1223
6.4.4.75	Penalty Removal Screen	1223
6.4.4.76	Penalty Re-allocation Screen	1224
6.4.4.77	Penalty Switch Screen	1224
6.4.4.78	Resend Communication Screen	1224
6.4.4.79	Revisions/Audit Trail - List Screen	1225
6.4.4.80	Securities Position - Details Screen	1227
6.4.4.81	Securities Positions - Search/List Screen	1227
6.4.4.82	Securities Postings - Search/List Screen	1227
6.4.4.83	Securities Restriction Details - Search/List Screen	1228
6.4.4.84	Settlement Instruction - Details Screen	1228
6.4.4.85	Settlement Instruction - New Screen	1228

6.4.4.86	Settlement Instructions - Search/List Screen	1233
6.4.4.87	Status History - Details Screen.....	1233
6.4.4.88	T2S DCA Balance - Details Screen	1233
6.4.4.89	T2S DCA Balances - Search/List Screen	1233
6.4.4.90	T2S DCA Postings - Search/List Screen	1233
6.4.4.91	Total Amount of Standing/Predefined Liquidity Transfer Orders - Search/List Screen.....	1234
6.4.4.92	Total Collateral Value per T2S Dedicated Cash Account - Search/List Screen.....	1234
6.4.5	Privilege Classes for LTSI Screens.....	1234
6.4.6	Privileges for LTSI Screens.....	1235
6.4.6.1	BSIQ.01 - Multi-criteria search of a set of Settlement Instructions - List Screen	1235
6.4.6.2	BSIQ.00 - Individual Settlement detailed Query – List Screen	1236
6.4.6.3	BSIQ.00 - Individual Settlement detailed Query – Search Screen	1236
6.4.6.4	BSIQ.01 - Multi-criteria search of a set of Settlement Instructions - Search Screen	1236
6.4.6.5	BSIQ.02 - Individual Restriction detailed Query – List Screen	1237
6.4.6.6	BSIQ.02 - Individual Restriction detailed Query – Search Screen	1237
6.4.6.7	BSIQ.03 - Multi-criteria search of a set of Settlement Restrictions - List Screen	1237
6.4.6.8	BSIQ.03 - Multi-criteria search of a set of Settlement Restrictions - Search Screen	1238
6.4.6.9	BSIQ.04 - Multi-criteria search of a set of Liquidity Transfers - List Screen.....	1238
6.4.6.10	BSIQ.04 - Multi-criteria search of a set of Liquidity Transfers - Search Screen.....	1238
6.4.6.11	BSIQ.05 - Multi-criteria search of a set of Business Cancellations - List Screen	1239
6.4.6.12	BSIQ.05 - Multi-criteria search of a set of Business Cancellations - Search Screen	1239
6.4.6.13	BSIQ.06 - Multi-criteria search of a set of Amendment Instructions – List Screen	1239
6.4.6.14	BSIQ.06 - Multi-criteria search of a set of Amendment Instructions - Search Screen	1240
6.4.6.15	BSIQ.07 - Multi-criteria search of a set of Hold and Release Instruc- tions - List Screen	1240
6.4.6.16	BSIQ.07 - Multi-criteria search of a set of Hold and Release Instruc- tions - Search Screen.....	1240
6.4.6.17	BSIR.00 - T2SDCA: Finalised matched Instructions – List Screen	1241

6.4.6.18	BSIR.00 - T2SDCA: Finalised matched Instructions – Search Screen	1241
6.4.6.19	BSIR.01 - Securities Account: Finalised matched Instructions - List Screen.....	1241
6.4.6.20	BSIR.01 - Securities Account: Finalised matched Instructions - Search Screen	1241
6.4.6.21	BSIR.02 - T2SDCA: Detailed Finalised matched Settlement Instruc- tions - List Screen	1242
6.4.6.22	BSIR.02 - T2SDCA: Detailed Finalised matched Settlement Instruc- tions - Search Screen.....	1242
6.4.6.23	BSIR.03 - Securities Account: Detailed Finalised matched Settlement Instructions - List Screen.....	1242
6.4.6.24	BSIR.03 - Securities Account: Detailed Finalised matched Settlement Instructions - Search Screen.....	1242
6.4.6.25	BSIR.04 - T2SDCA: Follow-up by time slot of Settlement Activity - List Screen	1243
6.4.6.26	BSIR.04 - T2SDCA: Follow-up by time slot of Settlement Activity - Search Screen	1243
6.4.6.27	BSIR.05 - T2SDCA: Comparison of Settlement activity between two time periods - List Screen	1243
6.4.6.28	BSIR.05 - T2SDCA: Comparison of Settlement activity between two time periods - Search Screen.....	1243
6.4.6.29	CMBR.00 - Journaling of Limit Utilisations of Primary CMB - Search Screen.....	1244
6.4.6.30	CMBR.00 - Journaling of Limits Utilisations of Primary CMB - List Screen.....	1244
6.4.6.31	CMBR.01 - Journaling of Limits Utilisations of Secondary CMB - List Screen.....	1244
6.4.6.32	CMBR.01 - Journaling of Limits Utilisations of Secondary CMB - Search Screen	1244
6.4.6.33	COLL.00 - T2SDCA: Follow-up by time slot of Settled Collateralisa- tion Instructions - List Screen.....	1244
6.4.6.34	COLL.00 - T2SDCA: Follow-up by time slot of Settled Collateralisa- tion Instructions - Search Screen	1244
6.4.6.35	COLL.01 - Securities Accounts: Follow up by time slot of Settled Col- lateralisation Instructions - Search Screen.....	1245
6.4.6.36	COLL.01 - Securities Accounts: Follow-up by time slot of Settled Col- lateralisation Instructions - List Screen	1245
6.4.6.37	COLL.02 - T2SDCA: Settled or Cancelled (automatic or manual) Col- lateralisation Instructions - List Screen	1245
6.4.6.38	COLL.02 - T2SDCA: Settled or Cancelled (automatic or manual) Col- lateralisation Instructions - Search Screen.....	1245

6.4.6.39	CPST.00 - T2SDCA: Follow-up by time slot of Cash Postings - List Screen.....	1245
6.4.6.40	CPST.00 - T2SDCA: Follow-up by time slot of Cash Postings - Search Screen	1246
6.4.6.41	LIQU.00 - Liquidity Transfers - List Screen	1246
6.4.6.42	LIQU.00 - Liquidity Transfers - Search Screen.....	1246
6.4.6.43	REAL.00 - Detailed Realignment and Other Technical Instructions - List Screen	1246
6.4.6.44	REAL.00 - Detailed Realignment and Other Technical Instructions - Search Screen	1246
6.4.6.45	REST.00 - Detailed Cash Restrictions - List Screen	1247
6.4.6.46	REST.00 - Detailed Cash Restrictions - Search Screen	1247
6.4.6.47	REST.01 - Detailed Securities Restrictions - Search Screen	1247
6.4.6.48	REST.01 - Detailed Securities Restrictions - List Screen.....	1247
6.4.6.49	SPST.00 - Securities Account: Follow-up by time schedule of Securities Postings - List Screen.....	1248
6.4.6.50	SPST.00 - Securities Account: Follow-up by time schedule of Securities Postings - Search Screen	1248
6.4.6.51	XREP.00 - T2SDCA: Matched Cancelled Instructions - List Screen	1248
6.4.6.52	XREP.00 - T2SDCA: Matched Cancelled Instructions - Search Screen.....	1249
6.4.6.53	XREP.01 - Securities Account: Matched Cancelled Instructions - List Screen.....	1249
6.4.6.54	XREP.01 - Securities Account: Matched Cancelled Instructions - Search Screen	1249
6.4.6.55	XREP.02 - Finalised Non Matched Cancellations - List Screen ..	1249
6.4.6.56	XREP.02 - Finalised Non Matched Cancellations - Search Screen	1250
6.4.7	Privileges for DWH Screens.....	1250
6.5	List of References for Error Messages	1251
6.5.1	Reader's Guide.....	1251
6.5.2	References for Error Messages for T2S GUI Screens	1251
6.5.2.1	All.....	1251
6.5.2.2	All Screens which allow the initiation of a query.....	1254
6.5.2.3	All Screens which allow the initiation of a second user action (4-eyes mode).....	1255
6.5.2.4	Allegement Instruction - Details Screen	1256
6.5.2.5	Allegement Instructions - Search/List Screen.....	1257
6.5.2.6	Amendment Cash Instruction - Details Screen.....	1257
6.5.2.7	Amendment Cash Instruction - New Screen	1257
6.5.2.8	Amendment Securities Instruction - Details Screen	1267



6.5.2.9	Amendment Securities Instruction - New Screen	1267
6.5.2.10	Available Report - Current Settlement Day Cash Information (Following Settlement Day Cash Forecast) Report – Details Screen	1281
6.5.2.11	Available Report - Details Screen.....	1282
6.5.2.12	Available Report - Statement of Accounts - Details Screen	1282
6.5.2.13	Available Report - Statement of Executed Amendment Instructions for Intra-Balance Movements - Details Screen	1282
6.5.2.14	Available Report - Statement of Executed Amendment Instructions for Intra-Position Movements and Settlement Instructions - Details Screen	1282
6.5.2.15	Available Report - Statement of Executed Cancellation Instructions for Intra-Balance Movements - Details Screen	1282
6.5.2.16	Available Report - Statement of Executed Cancellation Instructions for Intra-Position Movements and Settlement Instructions - Details Screen	1282
6.5.2.17	Available Report - Statement of Holdings - Details Screen	1283
6.5.2.18	Available Report - Statement of Pending Amendment Instructions for Intra-Balance Movements - Details Screen.....	1283
6.5.2.19	Available Report - Statement of Pending Amendment Instructions for Intra-Position Movements and Settlement Instructions - Details Screen.....	1283
6.5.2.20	Available Report - Statement of Pending Cancellation Instructions for Intra-Balance Movements - Details Screen.....	1283
6.5.2.21	Available Report - Statement of Pending Cancellation Instructions for Intra-Position Movements and Settlement Instructions - Details Screen.....	1283
6.5.2.22	Available Report - Statement of Pending Instructions - Details Screen	1283
6.5.2.23	Available Report - Statement of Pending Intra-Balance Movements - Details Screen.....	1284
6.5.2.24	Available Report - Statement of Pending Intra-Position Movements - Details Screen.....	1284
6.5.2.25	Available Report - Statement of Settled Intra-Balance Movements - Details Screen.....	1284
6.5.2.26	Available Report - Statement of Settled Intra-Position Movements - Details Screen.....	1284
6.5.2.27	Available Report - Statement of Settlement Allegements - Details Screen.....	1284
6.5.2.28	Available Report - Statement of Transactions - Details Screen ..	1284
6.5.2.29	Available Reports - Search/List Screen.....	1284
6.5.2.30	Broadcast - Details Screen.....	1285
6.5.2.31	Broadcast - New Screen.....	1285



6.5.2.32	Broadcasts - Search/List Screen	1285
6.5.2.33	Calendar - Details Screen	1286
6.5.2.34	Cancellation Cash Instruction - Details Screen	1286
6.5.2.35	Cancellation Cash Instruction - New Screen	1286
6.5.2.36	Cancellation Securities Instruction - Details Screen	1288
6.5.2.37	Cancellation Securities Instruction - New Screen	1288
6.5.2.38	Cash Forecast - Details Screen	1294
6.5.2.39	Cash Forecasts - Search/List Screen	1294
6.5.2.40	Collateral Value of a Security - Search/List Screen	1295
6.5.2.41	Collateral Value per T2S Dedicated Cash Account and Security - Search/List Screen	1295
6.5.2.42	Data Change - Details Screen	1296
6.5.2.43	Data Changes - Search/List Screen	1296
6.5.2.44	Default Event Schedule - Details Screen	1296
6.5.2.45	Hold/Release Instruction - Details Screen	1297
6.5.2.46	Hold/Release Instruction - New Screen	1297
6.5.2.47	Immediate Liquidity Transfer Order - Details Screen	1313
6.5.2.48	Immediate Liquidity Transfer Order - New Screen	1314
6.5.2.49	Immediate Liquidity Transfer Orders - Search/List Screen	1318
6.5.2.50	Inbound File - Details Screen	1320
6.5.2.51	Inbound Files - Search/List Screen	1320
6.5.2.52	Inbound Message - Details Screen	1321
6.5.2.53	Inbound Messages - Search/List Screen	1321
6.5.2.54	Insolvency procedure Settlement Instructions- Search/List Screen	1321
6.5.2.55	Intra-Balance Movement - Details Screen	1322
6.5.2.56	Intra-Balance Movement - New Screen	1322
6.5.2.57	Intra-Balance Movements - Search/List Screen	1341
6.5.2.58	Intra-Position Movement - Details Screen	1343
6.5.2.59	Intra-Position Movement - New Screen	1343
6.5.2.60	Intra-Position Movements - Search/List Screen	1367
6.5.2.61	Limit Utilisation - Search/List Screen	1369
6.5.2.62	Limit Utilisation Journal - Search/List Screen	1369
6.5.2.63	Maintenance Cash Instructions – Search/List Screen	1370
6.5.2.64	Maintenance Securities Instructions - Search/List Screen	1371
6.5.2.65	Outbound File - Details Screen	1371
6.5.2.66	Outbound Files - Search/List Screen	1372
6.5.2.67	Outbound Message - Details Screen	1373
6.5.2.68	Outbound Messages - Search/List Screen	1373
6.5.2.69	Outstanding Auto-Collateralisation Credits - Search/List Screen	1374
6.5.2.70	Overall Liquidity - Search/List Screen	1375
6.5.2.71	Penalty - Details Screen	1375

6.5.2.72	Penalty - Re-allocation Screen	1376
6.5.2.73	Penalty – Removal Screen	1378
6.5.2.74	Penalty - Switch Screen	1378
6.5.2.75	Queued Static Data Change – Details Screen	1379
6.5.2.76	Queued Static Data Changes – Search/List Screen	1379
6.5.2.77	Resend Communication Screen	1379
6.5.2.78	Revisions/Audit Trail - List Screen.....	1381
6.5.2.79	Securities Position - Details Screen	1381
6.5.2.80	Securities Positions - Search/List Screen.....	1381
6.5.2.81	Settlement Instruction - Details Screen	1382
6.5.2.82	Settlement Instruction - New Screen	1382
6.5.2.83	Settlement Instructions - Search/List Screen	1444
6.5.2.84	Status History - Details Screen.....	1447
6.5.2.85	T2S BIC Directory Items - Search/List Screen	1447
6.5.2.86	T2S DCA Balance - Details Screen	1448
6.5.2.87	T2S DCA Balances - Search/List Screen	1449
6.5.2.88	T2S DCA Postings - Search/List Screen	1450
6.5.2.89	Total Amount of Standing/Predefined Liquidity Transfer Orders - Search/List Screen.....	1451
6.5.2.90	Total Collateral Value per T2S Dedicated Cash Account - Search/List Screen.....	1452
6.5.3	References for Error Messages for TMS Screens.....	1452
6.5.3.1	Trouble Case - Search/List Screen	1452
6.5.3.2	Trouble Case - Details Screen	1453
6.5.3.3	Trouble Case - Export Screen	1453

Terms and Abbreviations

The terms and abbreviations used in the User Handbook, but not included in the T2S glossary are shown in the table below. You find terms with their description and the abbreviations, both in an alphabetical order.

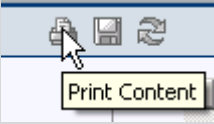
Letter	Description
A	
Alert icon 	An <i>alert</i> icon is an icon that is shown on an active T2S screen for those users with appropriate rights to approve a pending action.
A2A	Application-to-application
B	
BIC	Bank identifier code
C	
Check box 	Square box which can be filled with a checkmark by clicking on it with the mouse. In contrast to the radio button, you can select more than one option with a check box.
D	
DD	Day (e.g. used within the timestamp, every letter stands for one digit)
d	Decimal number
E	
e.g.	For example (Latin: 'exempli gratia')
G	
GUI	Graphical user interface which is a type of user interface which allows users to interact with electronic devices.
H	
hh	Hour (e.g. used within the timestamp, every letter stands for one digit)
I	
i.e.	That is (Latin: 'id est')
IP port	Internet Protocol address port, is the port which connects a numerical label assigned to each device (e.g., computer, printer) participating in a computer network that uses the Internet Protocol for communication.
Incl.	Including

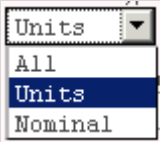
Letter	Description
M	
Mouse-over 	Additional information for some elements of the GUI is only shown when you move the mouse-pointer to these elements.
MM	Month (e.g. used within the timestamp, every letter stands for one digit)
mm	Minute (e.g. used within the timestamp, every letter stands for one digit)
µsµsµsµsµs	Microsecond (e.g. used within the timestamp, every 'µs' stands for one digit)
min.	Minimum
max.	Maximum
10m	10 million
N	
NRO	Non-repudiation of origin (NRO) provides the recipient (T2S) with the evidence NRO which ensures that the originator (T2S actor) will not be able to deny having sent the U2A instruction. The evidence of origin is generated by the originator and held by the recipient.
Q	
QQ	Quarter, indicates a time span of three months, e.g. Q2 stands for the second quarter of the year.
R	
Radio button 	A type of GUI element which allows the user to choose only one of a predefined set of options.
S	
Select box 	A select field in the GUI with an arrow on the right side. By clicking on the arrow, all possible input values are shown and can be selected with a mouse-click.
SS	Semester, indicates a time span of six months, e.g. S1 stands for the first semester.

Letter	Description
ss	Second (e.g. used within the timestamp, every letter stands for one digit)
T	
10t	10 thousand
Timestamp	A sequence of characters, denoting the date and the time in T2S.
U	
UHB	User Handbook
U2A	User-to-application
Y	
YYYY	Year (e.g. used within the timestamp, every letter stands for one digit)

1 Introduction

1.1 Overview of the User Handbook

The T2S User Handbook, hereinafter called UHB, aims at facilitating the use of the Graphical User Interface of TARGET2-Securities (T2S GUI) and related common components: Common Reference Data Management (CRDM), Business Day Management (BDM), Billing common component (BILL). It is intended for any T2S user regardless of the focus of activities and describes the full range of functionalities available in user-to-application (U2A) mode. The UHB provides detailed reference information on all GUI screens and step-by-step instructions for typical workflows.

Target Audience There is only one handbook addressing all T2S actors: central banks (CBs), central securities depositories (CSDs), CSD participants, external CSD users, payment banks/settlement banks. By referring to the table of contents as well as to the usage indication list, each reader can easily identify the relevant parts.

Related Documentation The UHB is part of the functional documentation and complements the general, technical and detailed specifications. Among these, the UDFS is particularly relevant for UHB readers. Although it is mainly focused on the application-to-application mode (A2A), chapter one of the UDFS contains a detailed description of the business concepts used in T2S, which are also relevant when using the GUI.

In addition to the T2S specifications, the Business Functionality for T2S Graphical User Interface - as the basis for the design and implementation of the GUI - provides helpful information. References to the GUI Business Functionalities are made in the screen descriptions of the UHB.

Both documents are available on the ECB's T2S webpage.

Updates Updated versions of the UHB will be provided on a regular basis.

1.1.1 UHB Methodology

Several symbols and methodological elements are used throughout the T2S UHB to ease orientation and help you to find your desired information quickly.

Page Layout Every page of the main UHB parts has a similar page layout. You can find four different elements:

- the header, which shows the chapter and sub-chapter title
- the margin column on the left side of each page, which is used for subheadings and information signs
- the text column, which contains the main information, tables and screenshots
- the footer, which shows the name and the release of the document as well as the page number

Information Signs	Name	Icon	Description
	Notice sign		Notice signs are used to highlight useful information. Read its content to find out about hints, action alternatives or other details helping you to improve your usage of the T2S GUI.
	Example sign		Example signs are used to highlight examples, which illustrate the corresponding text, especially when a verbal description is difficult or too extensive.

Links Links are illustrated throughout the UHB with a little triangle followed by a page number within squared brackets. These links help you to jump to related sections by clicking on them or turning to the relevant page.

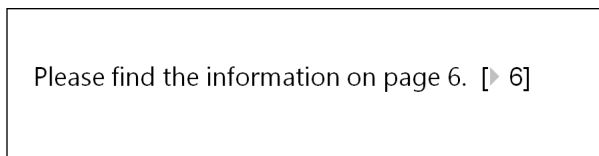

Illustration 1: Link illustration

Tables Tables are used to present information in a clearly arranged format. They consist of a table head and a table body. The body is divided into a left and a right column. The left column contains keywords, for example field names, which are explained in the right column. Subsections within a table are preceded by a heading. The order of the description follows the appearance on the screen from left to right and from top to bottom.

Type Set Regular text in the UHB is written in Arial Unicode MS font with a size of 11pt. Screen and button names are written in italic letters, GUI paths use the Courier New font. Field names and field values are put in quotation marks if they appear in a context other than their dedicated description.

Element	Format	Example
Screen name	Italic letters	<i>Data changes – search/list</i> screen
Button name	Italic letters	<i>New</i> button

Element	Format	Example
GUI path	PC code	T2S >> Market-Specific Configuration >> Market-Specific Attributes >> Search
Field name or value quotation	'...'	'Opening Date' ; 'Active'

Action Steps

Business scenarios are divided into single action steps. These action steps are numbered sequentially. Intermediate results are described where appropriate and marked with an indented arrow. Each business scenario ends with a final result, indicated by an arrow.



Example

1. Action step 1
2. Action step 2
 - ➔ Intermediate result
3. Action step 3
 - ➔ Result

Screenshots

Screenshots are used to illustrate the corresponding text. Note that there might be minor deviations between the screenshot and your screen appearance, according to your access rights or a specific selection you have made. Also, some functions are mutually exclusive and cannot be represented in a single screenshot. In these cases, the screenshot illustrates the more prevalent use of the screen.

Values shown on a screenshot might also deviate from the default values indicated in the description. In these cases, the description is valid rather than the screenshot.

Wherever relevant, specific parts of a screenshot are highlighted with a red box. If there is more than one box, position numbers point out the relation to the corresponding description.

SECURITIES CASH SERVICES MONITORING

Cash > Liquidity > Immediate Liquidity Transfers > New Immediate Liquidity Transfer

version 0.91-01

Immediate Liquidity Transfer

Debit Cash Account

T2S Dedicated Cash Account Number * T2S Dedicated Cash Account Owner

Debitor BIC 1

Liquidity Transfer

Users Reference * Amount *

T2S

Credit Cash Account

Outbound Liquidity Transfer Internal Liquidity Transfer

External Account Number * T2S Dedicated Cash Account Number

Creditor BIC

Illustration 2: Screenshot with red box and position number

1.1.2 UHB Structure

The UHB is structured in five parts and is complemented by an annex.

Part 1

The **introduction** explains the aim, the content and the approach of both the UHB and the GUI. While the first section explains how to use the UHB, the second section focuses on the design and common functionalities of the GUI.

The overview of the UHB includes information about:

- The UHB methodology [▶ 26]
- The UHB structure [▶ 29]

The overview of the GUI consists of information about:

- Setup and login procedures [▶ 31]
- GUI structure for T2S GUI [▶ 32], including information about the menu structure [▶ 32], screen structure [▶ 33], screen types [▶ 35], field types and properties [▶ 37], and common buttons and icons [▶ 43]
- GUI structure for CoCo GUI [▶ 57], including information about the menu structure [▶ 58], screen structure [▶ 58], screen types [▶ 60], field types and properties [▶ 61], and common buttons and icons [▶ 68]
- Validation [▶ 49]
- Communication network and services [▶ 54]
- User administration [▶ 54]
- Security and certification services [▶ 54]
- Online help [▶ 54]

Refer to this part if you need information on how to use the UHB or on common functionalities of the GUI.

Part 2

The **screen reference part** starts with a general section serving as a reader's guide for this part. It is followed by the screen descriptions of all screens contained in the GUI. Each description follows an identical structure which comprises detailed information on all screen fields.

The screen reference part is structured along the first and second GUI menu level, followed by the screens in alphabetical order. Within this alphabetical order, all screen types belonging to the same business function are grouped together to follow the business logic (*search/list* screen, *details* screen, *new/edit* screen).

Refer to this part if you need detailed and precise information on a screen, field or button.

Part 3

The **user instructions part** starts with a general section serving as a reader's guide for this part. It is followed by step-by-step instructions for typical GUI workflows, called business scenarios. Each description follows an identical structure.

Related business scenarios are grouped into comprehensive business packages, which are further grouped into categories.

Refer to this part if you need to know how to carry out an action using the GUI.

Part 4

The **trouble management system (TMS)** part offers an overview of the TMS screens that are available in U2A mode. Refer to this part if you need a description and explanation of the usage and functionalities of the TMS external interface to the relevant users.

TMS is a tool and database which is used to track and follow-up on relevant communication between the T2S users and the T2S Service Desk for which a trouble case has been created.

Annex

The **annex** supplies detailed information complementing the UHB:

- Annex A - Indication of usage [▶ 1130]: List of primary users (CSD or CB) for each screen and business scenario
- Annex B - Sitemap [▶ 1143]: Hierarchical, structured illustration of all screens and their interrelations
- Annex C - List of privileges [▶ 1170]: For each screen, all privileges and their corresponding description are listed
- Annex D - List of references for error messages [▶ 1251]: For each screen (incl. TMS screens), all references for error messages, the error text and the corresponding description are listed

1.2 Overview of the Graphical User Interface for T2S GUI

The GUI is a browser-based application for communication with T2S in U2A mode. It is based on the ISO norm 9241 'Ergonomics of human system interaction'.

1.2.1 Setup and Login Procedures

Before entering the GUI, make sure that your workstation complies with the hardware and software requirements and implement all necessary preparations (e.g. firewall settings) described below.

Hardware Requirements	Please refer to ESMIG qualified configurations document annexed to the ESMIG UDFS.
Software Requirements	Please refer to ESMIG qualified configurations document
Supported Web-Browsers and Settings	Please refer to ESMIG qualified configurations document annexed to the ESMIG UDFS.
Firewall Settings	Please refer to ESMIG qualified configurations document annexed to the ESMIG UDFS.
GUI Access	Users are directed to an initial page named ESMIG portal that ensures proper routing to the web applications the user has been granted to enter.
Authentication	Authentication takes place on the login screen provided by the network provider (SWIFT or SIA COLT). On this login screen you are requested to authenticate yourself via the certificate used together with your password. Both pieces of information (choosing a certificate and typing in a password) are only required once at the beginning of every session and the authentication remains active for the entire session.
System User Reference	Please refer to ESMIG qualified configurations document annexed to the ESMIG UDFS.
Limitations of the T2S GUI	The T2S GUI is designed as a user interface where a user handles entries into the T2S GUI and views the result of queries, reports etc. on his computer screen. It is recommend to use the T2S GUI in a restrictive way, i.e. using search parameters to limit the resulting data volume and avoid open ended queries.

In case the user does not consider this limitation the T2S GUI would first wait and finally could run into a time-out. Depending on various parameters (bandwidth, concurrent users, customer infrastructure processing, DB query duration, record size, operational day phase, timeout limitation) further effects may be encountered.

1.2.2 GUI Structure

This chapter explains the basic elements of the T2S GUI structure (i.e. structure of the menu and the screens) helping you to navigate through the system and to use it quickly and efficiently.

The first subsection describes the menu structure where screens are grouped hierarchically. Afterwards, the second subsection explains the layout structure common to each screen. The following subsections provide details on the different screen types [▶ 35] and on recurring elements, such as common field types [▶ 37] or buttons and icons [▶ 43].

1.2.2.1 Menu Structure

The GUI menu is structured into three hierarchical menu levels. The first level is presented as a menu bar containing the five first-level menu items, which are always visible on top of each screen.



Hint

Depending on your access rights, it is possible that not all menu entries are visible for you. Contact your system administrator to verify that you have the necessary privileges to access all screens relevant to you. The privileges are listed in each screen and business scenario description.

The items are colour-coded for ease of referencing:

- Securities (orange)
- Cash (green)
- Services (blue)
- Monitoring (yellow)

The second and third menu levels are accessible via mouse-over on the first-level menu items.

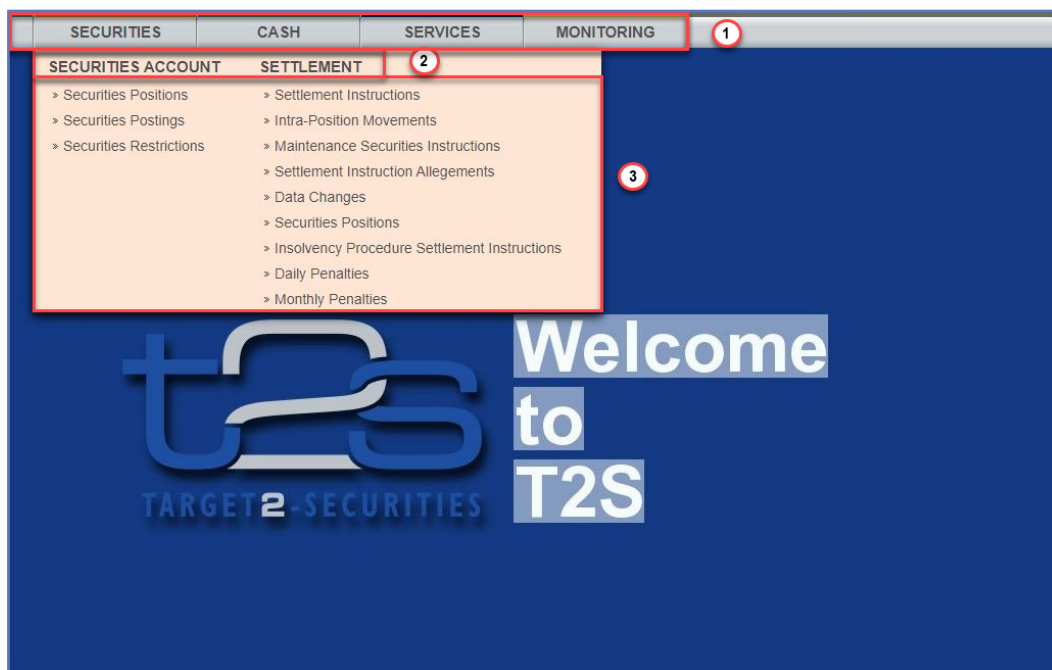

Illustration 3: T2S menu levels

Position No.	Description
1	Menu level 1
2	Menu level 2
3	Menu level 3

All entries on the second menu level are structural subcategories. To access a screen you have to click on the third menu level. For ease of use, some screens are available more than once. All identical menu entries on level three lead to the same screen. You can arbitrarily access them according to your business preferences.



Example

The *securities positions – search/list* screen can be accessed via the following two paths:

- Securities >> Securities Account >> Securities Positions
- Securities >> Settlement >> Securities Positions

1.2.2.2 Screen Structure

In general, each screen of the T2S GUI follows the same layout containing a header and a content area.

Header

The header appears at the top of every screen. It contains four main elements providing useful information and helping you to navigate between the different screens as shown in the illustration below.

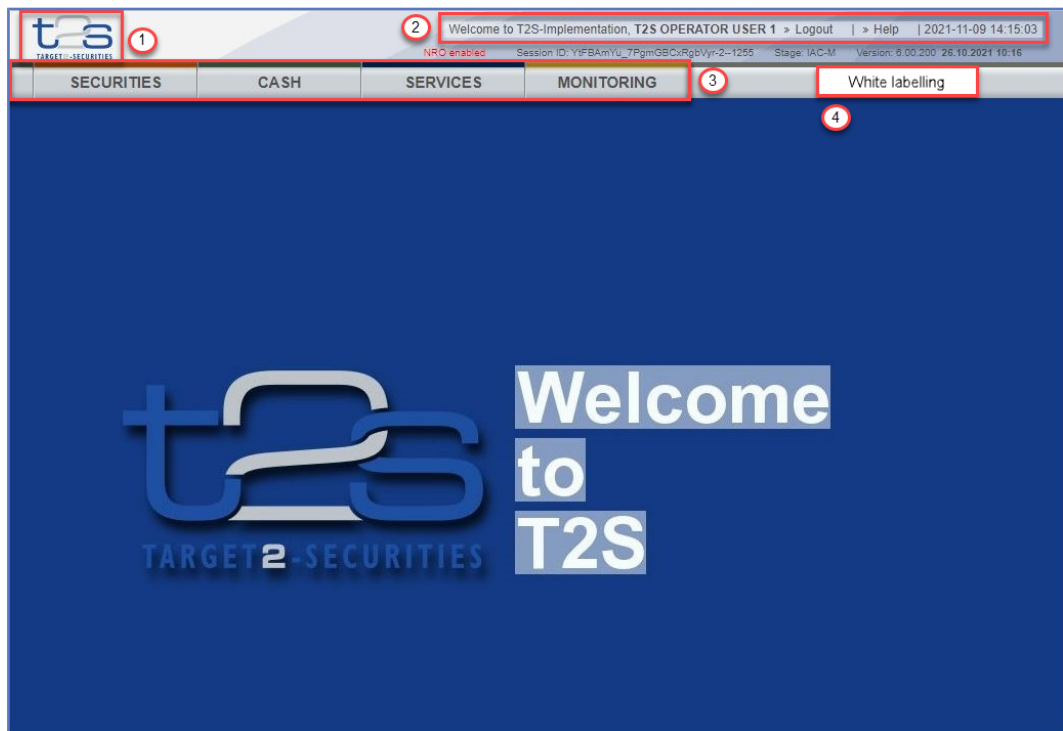

Illustration 4: Header elements

Position No.	Element	Description
1	T2S logo button	... links to the welcome screen. While using the <i>new/edit</i> screens, the <i>T2S logo</i> button is locked in order to ensure a safe and complete submission process.
2	Information panel	... displays your login name, the <i>logout</i> and <i>help</i> buttons as well as date and time of last data access.
3	Menu bar	... presents the five main menu items and allows you to navigate to the screens.
4	T2S System User Reference logo	... displays the respective logo in accordance with the chosen T2S system user reference in line with the white-labelling approach.

Content Area

The content area is the part of the GUI where you can trigger all business actions. It is organised by five main elements which help you to interact properly with the GUI as shown in the illustration below.

To structure large amounts of data, the content area is further separated into frames and sub-frames.

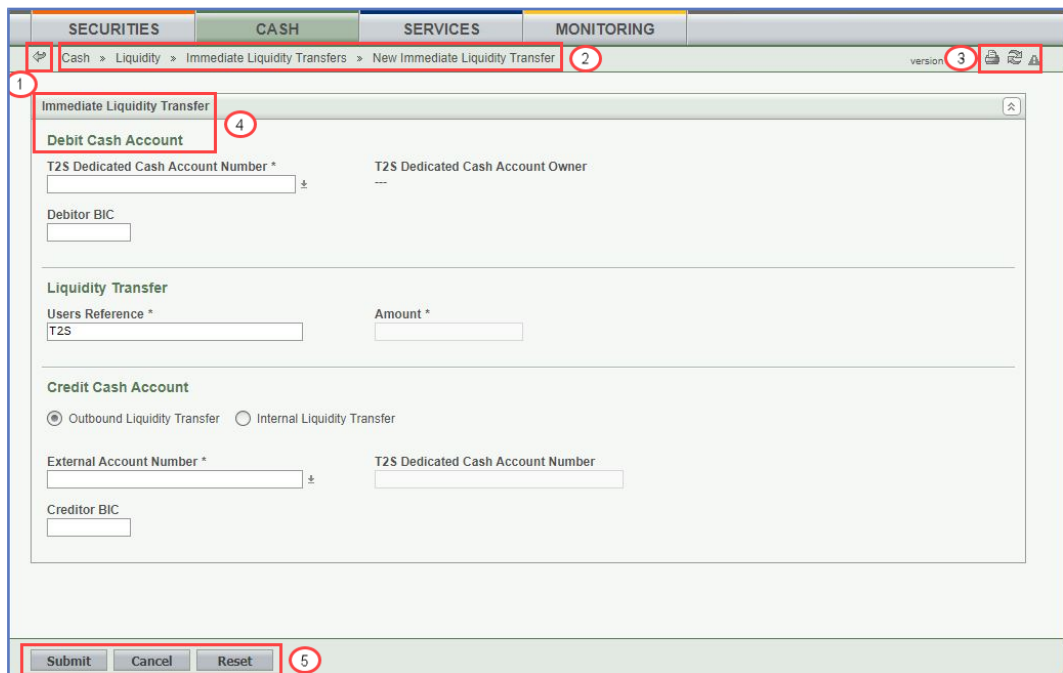

Illustration 5: Content area elements

Position No.	Element	Description
1	Back icon	... leads to the previous screen.
2	Breadcrumb	... shows the main path to the current screen.
3	Print icon	... prints the screen content.
	Export icon	... exports the content, which can then be saved to your local directory.
	Refresh icon	... reloads the screen.
4	Frame and sub-frame title	... groups related information as a structural function.
5	Button bar	... shows all available buttons for the current screen.

Further information about the icons can be found in the common buttons and icons section [▶ 43].

1.2.2.3 Screen Types

The T2S GUI consists of the following types of screens, each with a different function:

- Welcome screen
- Search/List screen
- Details screen
- Enter screen (usually *new* or *edit* screen)

Welcome Screen	The <i>welcome</i> screen is the entrance into the T2S GUI and allows you to choose your system user reference. It also contains a ticker line providing you with the latest information. The ticker is managed by the T2S operator.
Search/List Screen	<p>Generally, you can access all <i>search/list</i> screens on menu level three. You can find all possible ways of accessing the screen directly in the respective screen description within the screen reference part.</p> <p>The <i>search/list</i> screen allows you to query the T2S database using a predefined set of search criteria. After executing a search, a list of data records matching your search criteria is displayed in a table. To select an entry from a list displayed on a <i>search/list</i> or <i>list</i> screen, click on the desired entry. The background colour of the table line changes to indicate the selected entry. If the search retrieves only one record, the <i>details</i> screen is displayed directly, if you are authorised to access the details screen, else the record is displayed in the table in the list screen. You can browse through the list using the table buttons [▶ 43]. Furthermore, it is possible to arrange your search results in ascending or descending order by the columns shown. This does not trigger a refreshed query.</p>



Hint

If you find underlined static data objects (e.g. like a hyperlink on a webpage) in a list, this is an indication that there is further information available. By clicking on such an entry a new query is started and the corresponding information to this entry is shown in a separate pop-up window.

You can also execute a new search with different search criteria by changing the values in the search fields and clicking on the *search* button, triggering a new query.

The search/list function is usually combined in one screen. Before proceeding further with a screen button, select one of the data records in the table by clicking on it.



Hint

If you submit a query for a business object (e.g. eligible counterparty CSD) in a 'Valid from - Valid to' range, the query retrieves the values of the main business object and the values of the linked business object (e.g. investor BIC, parent BIC).

For the main business object, you receive the valid values of the 'Valid from - Valid to' range.

For the linked business object, you always receive the currently valid values of the date of the search and not the valid values of the 'Valid from - Valid to' range.

Details Screen In contrast to the *search/list* screen, you can only access the *details* screens via other screens. As the only exception, the *T2S calendar* screen is already available on menu level three. You can find all possible ways of accessing the screen via other screens in the respective screen description within the screen reference part.

All *details* screens provide you with in-depth information of a previously selected data record.

Before showing the *details* screen, a new query is forwarded to the system to ensure most up-to-date data.

Enter Screen Similar to the *details* screens, you can only access the *enter* screens through other screens, except for the *resend communication* screen, which is already available on menu level three.

Enter screens allow you to enter data, which can be done in two enter modes:

- New mode, represented by the *new* screens
- Edit mode, represented by the *edit* screens

In general, both modes contain the same fields. In the case of the *new* mode, all fields are blank. In the case of the *edit* mode, existing data are prefilled in the fields. In addition, one past value is reported (if available) which cannot be edited. You can edit the existing currently valid value by changing the content of the field. You can also enter a new future value by clicking on the *pencil* icon [▶ 43]. You can only edit an existing currently valid value if there is no future value stored.

As a general rule, all the 'Instructing Party BIC' and 'Instructing Party Parent BIC' fields are automatically filled in with the respective 'Party BIC' of the current GUI user in case they are not filled in when clicking on the *submit* button.

1.2.2.4 Field Types and Properties

On *search/list* and *enter* screens, you can enter information via input fields and select fields. Information is displayed in read-only fields.

Field Types

Input Fields In input fields you can enter text and/or numeric content. Make sure to comply with the format requirements, which are part of each field/screen description.

Input-sensitive fields are input fields with an auto-complete mode that helps you to input data. As soon as you start typing the first characters of the respective data into an input-sensitive field, T2S automatically proposes possible matching entries from which you can select the desired one.

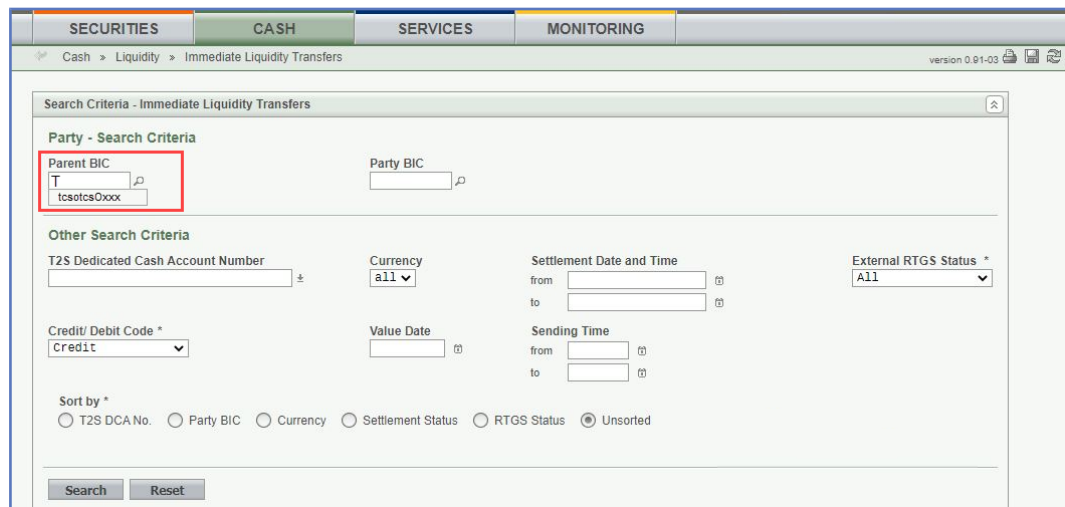

Illustration 6: Input- sensitive field



Hint

You can use the tab key on your keyboard to navigate through the GUI fields.

BIC8 that are entered via GUI are automatically supplemented to BIC11 by adding 'XXX' in order to unambiguously identify a party with the exception of the BICs referring to parties on party level 3-5 of the 'Settlement Instruction – New Screen'.

Select Fields

Select fields are either select boxes, radio buttons or check boxes.

- **Select boxes:** Functionally a select box is a way to enter data from a limited list of possible values. In T2S you can find different types of select boxes: standard select box and auto-complete select box.
- The **standard select box** enables you to choose one entry from a pre-defined set of values. To select an entry, click on the little box with the arrow to open the menu. Then select the desired value by clicking on it.

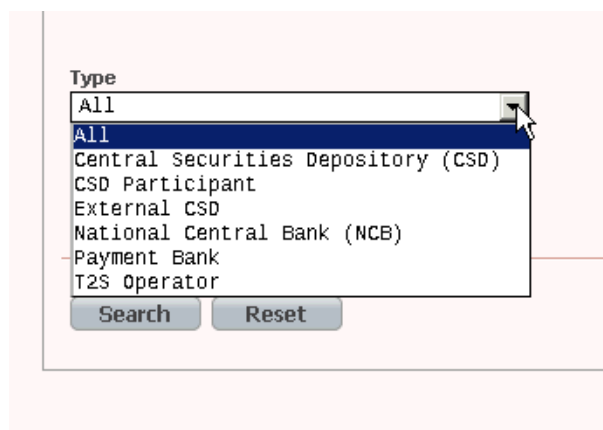

Illustration 7: Standard select box

The **auto-complete select box** enables you to either enter your desired value manually which will be used to reduce the possible set of values in the auto-complete select box to be chosen from or to click on the *auto-complete select box* icon, which provides you with a drop-down menu that shows the 10 first entries of the set of values irrespective of what you might have entered in the text field. In either way (meaning clicking on the icon or start typing an entry with the automatically shown list) up to 10 entries will be shown in the drop-down menu.



Auto-complete select box using the *auto-complete select box* icon and auto-complete select box with manually entered values.

The **google-style select box** enables you, on difference to the auto-complete select box, to make entries and choose values outside the standard set of values to be sent to the back-end for further validation (extended data scope). Due to that possibility of transporting unqualified data the validation of the values is restricted to basic checks and will be carried out mainly in the backend. Apart from that, the google-style select box functions similar to the auto-complete select box.



Illustration 8: Google-style select box

- Radio buttons:** Enable you to make exact selections using one value from a set of options. You can select only one value at the same time. Click on the icon corresponding to the option you would like to select.

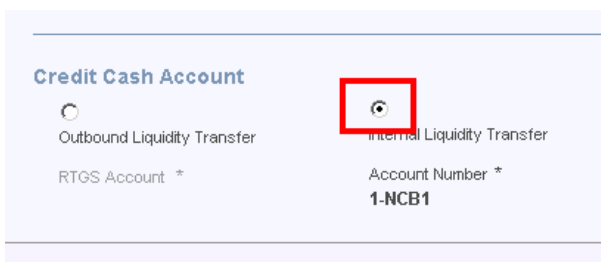

Illustration 9: Radio buttons

- Check boxes:** Enable you to select more than one value at the same time. Click on the boxes corresponding to the options you would like to select. Selected check boxes contain a check mark.

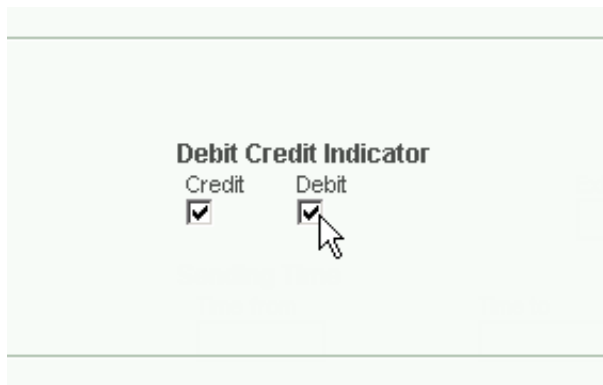

Illustration 10: Check boxes

Read-only Fields

In addition to enter and select fields, the T2S GUI has also read-only fields, which are pre-filled and do not allow data changes.

Field Properties

All field types have specific properties with respect to possible character sets, usage of wildcards and mandatory content.

Characters

T2S operates in British English and uses the SWIFT-x character set to enter data. After the coexistence, T2S will be using the UTF-8 character set with the exception of '<', '>' and '&'. Amounts are automatically displayed with decimal points. While negative amounts are displayed in red and marked with a '-', you can only type amounts that are greater than or equal to 0 into input fields, unless specified otherwise in the screen description.

The GUI does not differentiate between upper and lower case in terms of data input for input fields.



Hint

Use the abbreviations 10m to enter the amount of 10 million (10,000,000) and 10t to enter the amount of 10 thousand (10,000).

The SWIFT-x character set is used in the text fields during the period of coexistence and corresponds with the following content:

Character	Description
a - z	26 small characters of the Latin alphabet
A - Z	26 capital characters of the Latin alphabet
0 - 9	10 numeric characters
/	Solidus (slash)
-	Hyphen
?	Question mark
:	Colon

(Opening parenthesis
)	Closing parenthesis
.	Full stop
,	Comma
'	Apostrophe
+	Plus
	Space (blank)
CR	Carriage return
LF	Line feed



Hint

T2S does not process fields (mandatory or optional), that are only filled with blanks. Blanks appearing at the beginning or at the end of a field entry are deleted automatically without any notification.

Fields in a *list* or *details* screen, where the dataset was saved without an entry, are filled with '---'.

Some reference and identification fields need a reduced version of the SWIFT-x character set. For them, the character '/' cannot be accepted at the beginning or end of the string. Moreover the combination '// ' cannot be present in any part of the string itself.

These fields are identified by the SWIFT-x-red type.

Please note that because blank characters are always deleted from the beginning or end of the input – any sequence like ' / ' (for the beginning) or ' / ' (for the end) must be considered not accepted.

Wildcards

A wildcard is a placeholder for characters. In T2S you can use a wildcard in an input field to search for data. The required number of characters is indicated in the field description. You can use wildcards in two different ways:

- As a placeholder for one or more characters of the input value, use an asterisk ('*')
- As a placeholder for exactly one character of the input value, use a question mark ('?')



Examples

TARGET2*: The result list contains all data records beginning with 'TARGET2'.

*Securities: The result list contains all data records ending with 'securities'.

TARGET2-Securities: The result list contains all data records that have exactly one character before the 'TARGET2-Securities'.

The combination of several wildcards directly after each other is not possible (e.g. TARGET2?* or TARGET2**), but it is possible to use several wildcards within one entry (e.g. 'TARGET2-*').

To properly search with wildcards, you have to insert at least two or four characters depending on the field requirements. If the fields do not allow wildcards, it is mentioned explicitly in the respective field description (under format requirements). Please note that the wildcard functionality is only available for input fields and not for select boxes.

Mandatory Content

In the GUI all mandatory fields are marked with an asterisk in the label. All marked fields have to be filled in before you are allowed to proceed.

Illustration 11: Mandatory fields

Position No.	Description
1	Mandatory input field
2	Mandatory select field

1.2.2.5 Common Buttons and Icons

While working with the T2S GUI you will find that some buttons and icons appear regularly. There are three types of common elements:

- Basic icons, which you can find on every screen
- Utility elements, which represent functions within the content area
- Table elements, which you can find below data record lists on *search/list*

The buttons contained in the button bar are variable and therefore explained in the screen descriptions.

Basic Icons

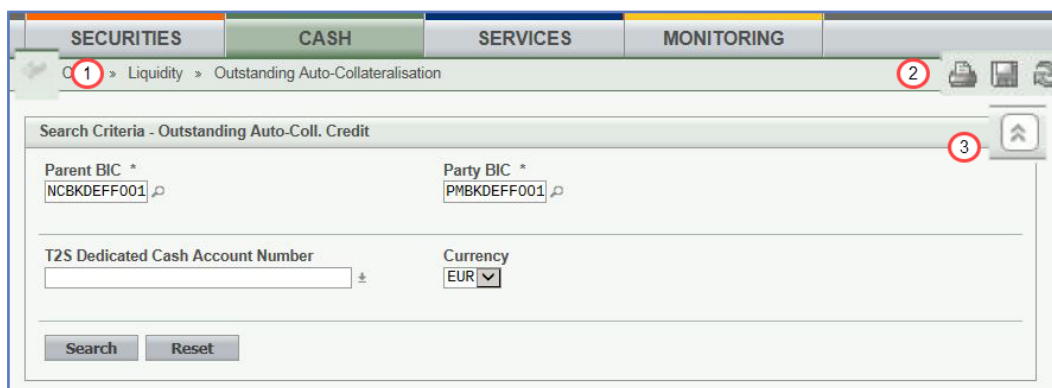

Illustration 12: Basic buttons

Position No.	Element	Description
1	<i>Back</i> icon	<p>... always leads to the previous functional screen.</p> <p>The usage of the <i>back</i> icon does not lead to an update or a refresh of the query of the screen.</p> <p>Do not use the <i>back</i> button of your web-browser to return to the previous screen, to avoid data loss.</p> <p>The <i>back</i> icon is common to all T2S screens except for the <i>welcome</i> and <i>search</i> screens.</p>
2	<i>Print</i> icon	<p>... prints the data of the current screen.</p> <p>The printout includes the name of the printed screen, the date and the time of printing, the data access time, the name of the user who triggered the printing, the classification label 'Restricted' and the data available on the screen.</p> <p>It is strongly recommended to use this button for generating a clearly arranged overview of data on the printout.</p>

Position No.	Element	Description
		<p>When printing a <i>list</i> screen on your standard printer, the whole list and search criteria are printed instead of only the part of the table visible on the screen.</p> <p>If you print an <i>edit</i> screen with data that have already been modified, the printout has the remark 'Changed Data'.</p> <p>If you print a <i>new</i> screen with data that have already been entered, the printout has the remark 'Not Stored Yet'.</p> <p>The <i>print</i> icon is common to all T2S screens except for the <i>welcome</i> screen.</p>
	<i>Export icon</i>	<p>... exports the data of the executed query from the current screen into a csv-file.</p> <p>Leading and trailing space-characters adjacent to comma field separators are to be ignored.</p> <p>If exporting a list, the related search criteria are exported as well whereas detailed data are only exported, if the respective <i>list</i> and the <i>details</i> screen are covered by the same query. Otherwise just the list entry will be exported.</p> <p>The <i>export</i> icon is common to all T2S screens except for the <i>welcome</i> and the <i>new</i> screens.</p> <p>In addition to the exported data from the screen the following information is exported at the start of the file: name of the exported screen (including menu path), current date, name of the user who triggered the exporting, classification label 'RESTRICTED', defined search criteria (query parameters, if applicable), 'CHANGED DATA' when exporting an <i>edit</i> screen which contains amended data that has not been submitted yet.</p>
	<i>Refresh icon</i>	<p>... reloads the screen.</p> <p>In new and edit modes the screen is locked, so it is not possible to refresh.</p> <p>The refresh function takes into account the search criteria that were chosen the last time the <i>search</i> button was clicked. Those search criteria will be displayed again.</p> <p>Changes that have not yet been saved are lost after using the <i>refresh</i> icon.</p>

Position No.	Element	Description
		The <i>refresh</i> icon is common to all T2S screens except for the <i>welcome</i> screen.
3	<i>Collapse</i> icon	... hides/displays the frame. When first entering a screen, all frames are shown but can be hidden according to your preference by using the <i>collapse</i> icon.

Utility
Elements

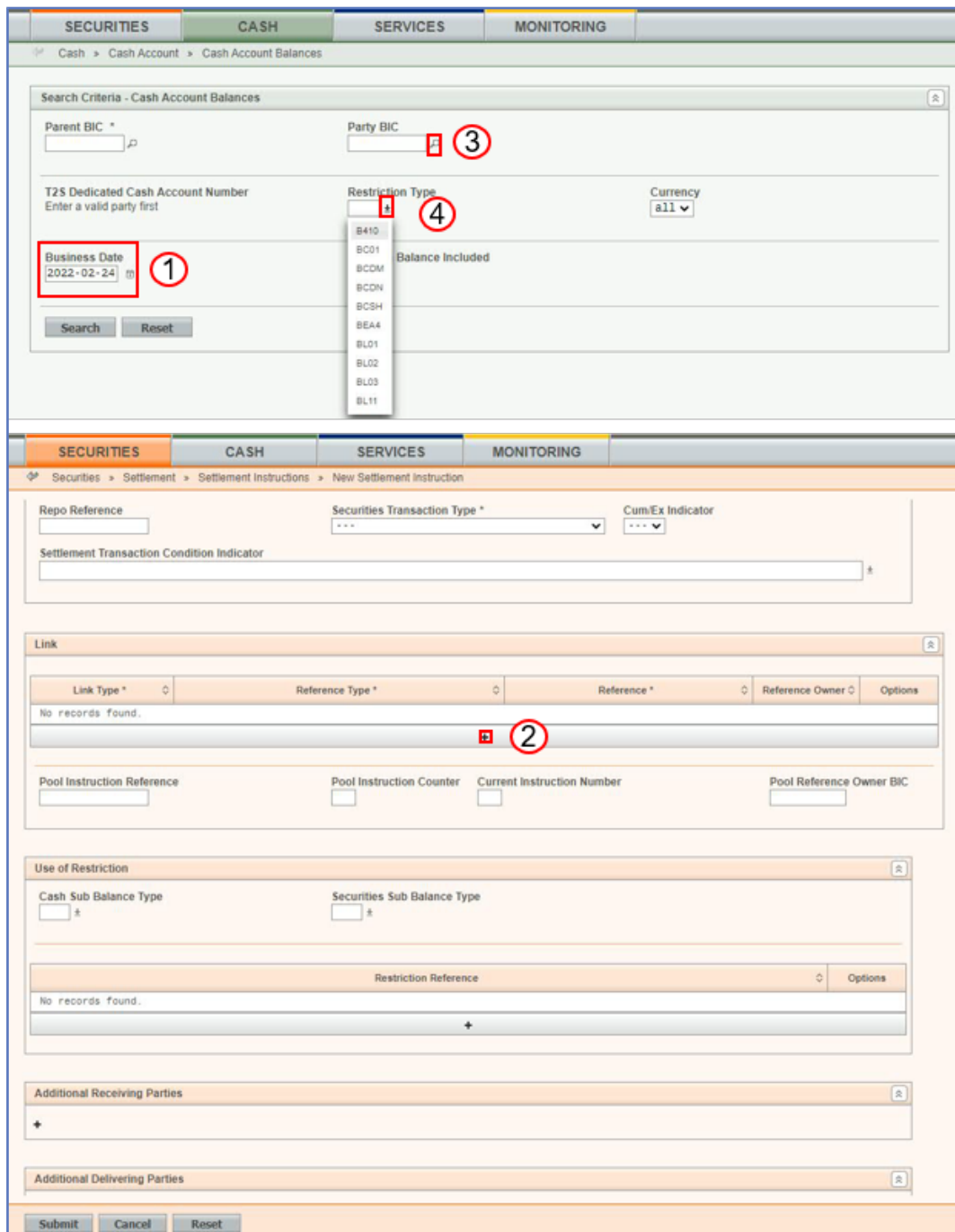

Illustration 13: Utility elements

Position No.	Element	Description
1	Calendar icon	... opens a calendar where you can select a day. If applicable, you can also select the time via the calendar icon.
2	Add row icon	... adds an empty row to the corresponding list.

Position No.	Element	Description
		<p>The <i>add row</i> icon is only available on <i>new</i> and <i>edit</i> screens.</p> <p>You can insert a maximum of 10 rows at a time.</p>
3	<i>Magnifier icon</i>	<p>... provides the possibility to search for data on other screens.</p> <p>If you are not aware of the exact/correct value, but you know other related data, click on the <i>magnifier</i> icon to enter the <i>search</i> screen. There you can enter all information known to you and execute a search. By clicking on the <i>select</i> button, you are redirected to the initial screen with the desired data entered in the respective fields.</p> <p>The attribute equipped with magnifier icon works otherwise like an auto-complete select box.</p>
4	<i>Auto-complete select box icon</i>	<p>...provides you the possibility to use the auto-complete functionality, while the drop-down menu opens when clicking on it.</p> <p>You can select one of the provided entries, when clicking on an entry in the list.</p>

Table Elements

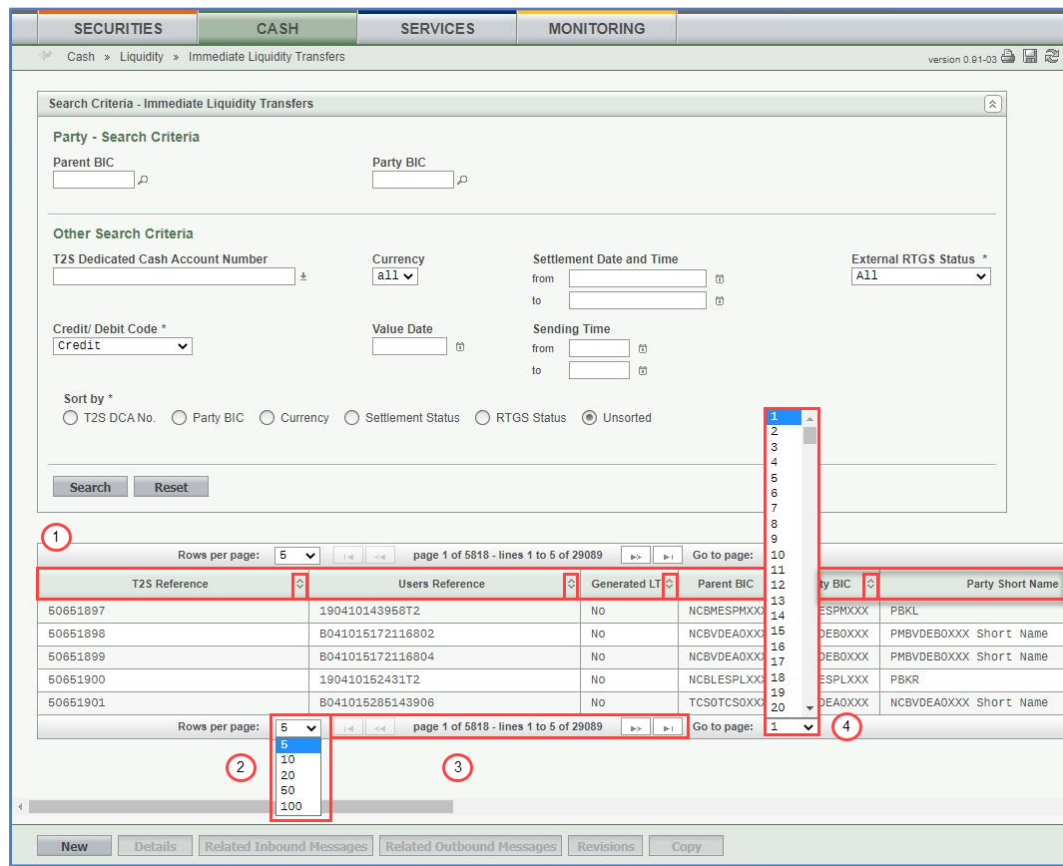

Illustration 14: Table elements

Position No.	Element	Description
1	Sort icon	... sorts the list in ascending or descending order by clicking on the up or down arrow.
2	Number of data records	... allows you to select the number of records displayed in the list. You can choose between 5, 10, 20, 50 or 100 data records to be displayed. The default number of data records to be displayed is 100.
3	First icon	... displays the first page of the list.
	Previous icon	... allows you to navigate through the displayed list and takes you to the previous page.
	Next icon	... allows you to navigate through the displayed list and takes you to the following page.
	Last icon	... displays the last page of the list.
4	Number of table pages	... allows you to select the table page number you would like to go to.

1.2.3 Validation

In T2S, all submission processes undergo various validations, which take place in the front-end and/or in the back-end. Only correct entries, fulfilling all predefined criteria, can be further processed. To indicate the status of the recently performed action, T2S uses two different types of messages to indicate a successful or failed validation as described below.

In addition to the automatic validation carried out by T2S, human validation can be imposed by using the 4-eyes mode.

Furthermore, non-repudiation of origin (NRO) is implemented for a specified number of screens.

Front-End Validation

As first part of the validation process, the front-end validation takes place without communication to the back-end. The front-end validation includes both the field validation and the cross-field validation. It is carried out after clicking on a button.

The field validation verifies that all entries comply with the required format.

The cross-field validation checks the data consistency between two or more fields/buttons in relation to each other.

Confirmation Prompt

In the case of business actions in 2-eyes mode, a confirmation prompt is shown after successful front-end validation to give you the opportunity to submit or reject the business action. This confirmation prompt does not appear in 4-eyes mode.



Illustration 15: Confirmation prompt

Back-End Validation

The back-end validation is the second part of the validation process. After successful front-end validation, your request is submitted to the back-end and checked for compliance with the business validation rules. In case of failure an error message is displayed. You can find a detailed list of all error messages and their description in the annex of the UHB (list of references for error messages [▶ 1251]).

Result

After each validation, the T2S GUI informs you about the result. There are two different message types available, the **error message** and the **success message**.

Error Message

Each error message is marked with a circle symbol and appears at the top of the content area and next to the field containing the error. In the case of a failed front-end or back-end validation, it indicates the source of the failure, the type of error and a short hint. This message is also shown as mouse-over text when you move the mouse cursor over the circle symbol next to the respective input field.

In case a Settlement Instruction or Settlement Restriction fulfils a rejection restriction type one positive rule, the error message provided in the GUI will also contain the relevant rule id fulfilled, **the restriction type name and its description**, in addition to the relevant error message applicable as described in the error messages annex of the UHB (list of references for error messages). {CR-525}

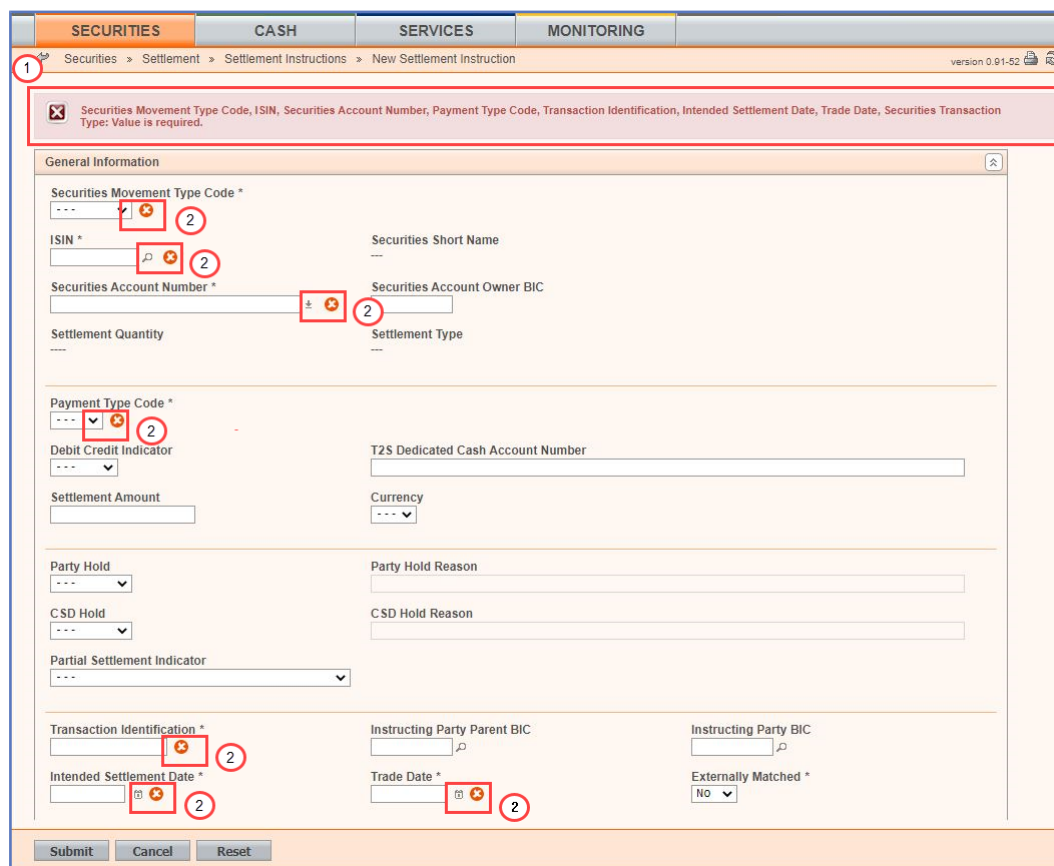

Illustration 16: Error message

Position No.	Description
1	Type of error and short hint
2	Source of the failure

Success Message

The success message appears in a green frame at the top of the content area. It confirms that your data have been submitted successfully.

In case a Settlement Instruction fulfils a CSD validation hold restriction type one positive rule, the success message provided in the GUI will also contain the relevant rule id fulfilled, **the restriction type name and its description**, in addition to the relevant error message applicable as described in the error messages annex of the UHB (list of references for error messages).

If the Settlement Instruction fulfils a rejection and/or CSD validation hold restriction type one negative rule, the success message provided in the GUI will also contain the relevant rule id fulfilled, **the restriction type name and its description**. The same applies in case a Settlement Restriction fulfils a rejection restriction type one negative rule. {CR-525}

If you are working in 4-eyes mode, the success message also provides you with the 4-eyes principle ID. This identification number helps you to search for the respective transaction via the *data changes – search/list* screen [▶ 608].

The screenshot displays the T2S GUI interface for an Immediate Liquidity Transfer. A green success message box is highlighted with a red border, containing the following text:

Success Message

Your data have successfully been submitted.

Your request was entered in 4-Eyes principle and a second user is needed to confirm.

Please find the 4-Eyes principle ID below:

123456

Below the message, the form for the Immediate Liquidity Transfer is visible. It includes the following sections:

- Debit Cash Account:** T2S Dedicated Cash Account Number * (123456789), T2S Dedicated Cash Account Owner * (UNGCIT21XXX).
- Liquidity Transfer:** User Reference * (User Reference 1), Amount * (11,002.32) EUR.
- Credit Cash Account:** Outbound Liquidity Transfer (External RTGS Account Number * 11223496745) and Internal Liquidity Transfer (T2S Dedicated Cash Account Number *).

At the bottom of the form, there are buttons for Submit, Cancel, and Reset.

Illustration 17: Success message

Queued Message

If you are submitting a static data request outside real-time settlement, your request could be queued. In this case, instead of the above mentioned success message the following message is shown: 'Your request has been queued successfully and will be resumed after the end of the current night-time settlement sequence'.

4-Eyes Mode Depending on the access rights setup, you can use T2S in 2-eyes or in 4-eyes mode. The 2-eyes mode and the 4-eyes mode apply for *enter* screens (new and edit mode) and for any kind of deletion processes. If you are a 4-eyes mode user, your actions have to be confirmed by a second user in order to be processed.

First User

In 4-eyes mode the first user enters, changes or deletes the data on a screen and afterwards submits the action by clicking on the *submit* button in the button bar. The success message appearing after successful validation includes a 4-eyes principle ID. For the final execution a second user is needed to confirm the action.

Second User

After the first user has entered, changed or deleted the data, a second user (with the required privilege) has to approve or revoke this action via the *data changes* screen [▶ 608] either using the 4-eyes mode ID or the search functionality.

An *alert* icon is shown on the active T2S screen for those users with appropriate privileges to approve a pending action via the *data changes* screen. By clicking on the *alert* icon you are directed to the *data changes - search/list* screen [▶ 608] where you can first search and then approve/revoke the pending changes.



Hint

Ask the first user for the 4-eyes principle ID and use it to limit the number of search results on the *data changes – search/list* screen.

As soon as the data changes are positively approved, T2S marks these data as approved and they are forwarded to further processing.

Digital Signature – NRO

In order to ensure non-repudiation of origin (NRO) for critical transactions, the use of a digital signature has been implemented for specified screens. This means that the user will be asked to enter a PIN code for signature purposes whenever an instruction is initiated. With the entry of the PIN, T2S attaches a digital signature to the instruction entered by the T2S actor.

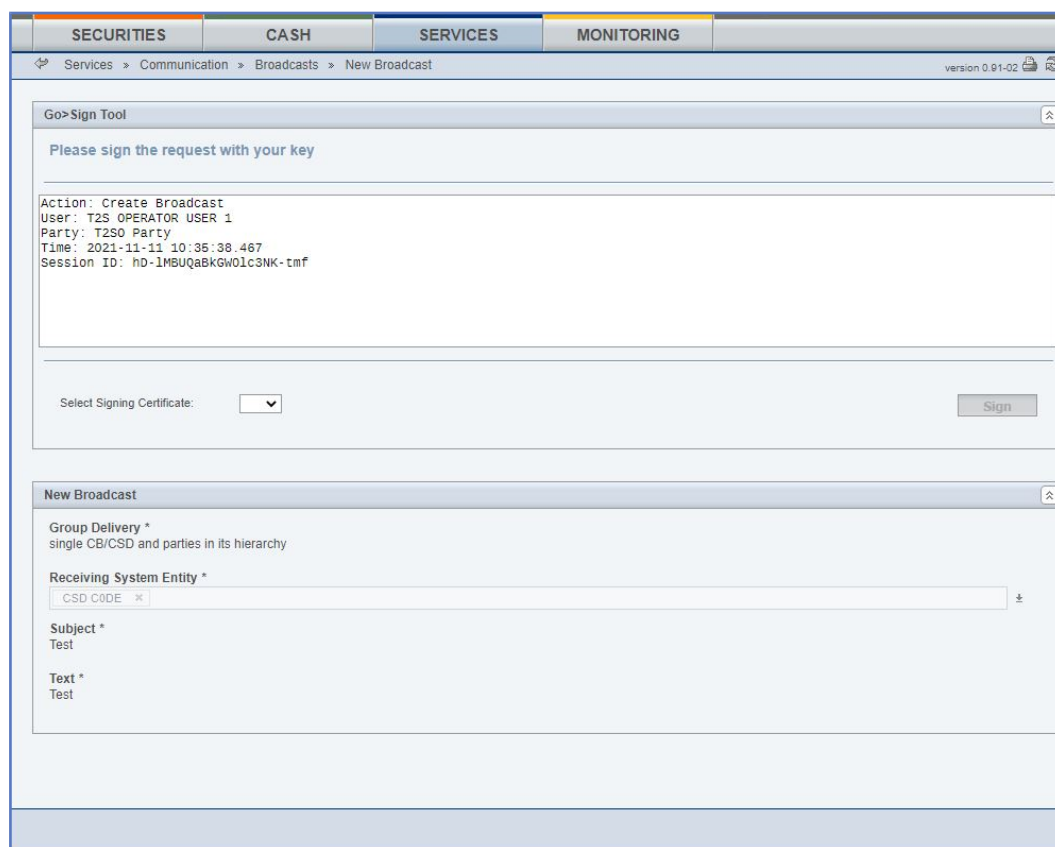

Illustration 18: Digital signature

The following (exhaustive) list provides an overview of screens for which the NRO feature is implemented:

- Amendment cash instruction - new screen* [▶ 410]
- Amendment securities instruction - new screen* [▶ 103]
- Broadcast - new screen* [▶ 622]
- Cancellation cash instruction - new screen* [▶ 420]
- Cancellation securities instruction - new screen* [▶ 117]
- Data change – details screen* [▶ 612]
- Hold/release instruction - new screen* [▶ 126]
- Immediate liquidity transfer order - new screen* [▶ 387]
- Intra-balance movement - new screen* [▶ 437]
- Intra-position movement - new screen* [▶ 151]
- Penalty – details screen* [▶ 291]
- Penalty - re-allocation screen* [▶ 318]
- Penalty - removal screen* [▶ 315]
- Penalty - switch screen* [▶ 322]
- Settlement instruction - new screen* [▶ 211]

1.2.4 Communication Network and Services

Refer to the T2S Connectivity Guide document for details on the communication network and services.

1.2.5 User Administration

Registration

Only registered users have access to the T2S GUI, therefore registration in T2S reference data and to the network is necessary prior to the first GUI access. The Registration Guide for User Testing provides information on how to fill in T2S Registration Forms properly, e.g. access rights or white labelling.

After registration the system administrator is given the possibility to grant and revoke privileges to its users within the T2S GUI as described in both the screen reference part and the user instructions part.

1.2.6 Security and Certification Service

In order to guarantee a secure and safe handling of the information and to protect customer data provided via the GUI, various security elements have been put into place:

- Each action requires system or human validation as described in the validation [▶ 49]
- The scope of available data and functions is controlled via the management of access rights
- The security features provided by the network providers and described in their respective user documentation prevent unauthorised access

1.2.7 Online Help

The content of the UHB can be accessed from the T2S GUI by clicking on the *help* button. The online help is context sensitive, which means that the screen description corresponding to the current screen is displayed. Other parts of the online help can be reached using the table of contents on the left side of the help window.

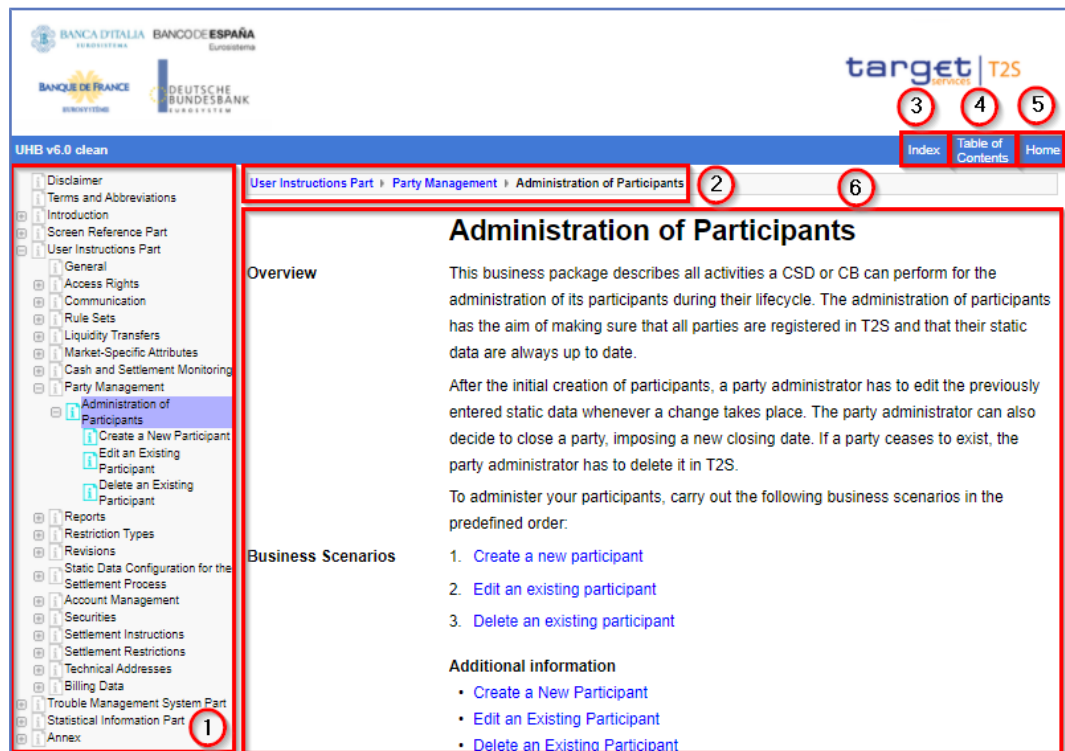

Illustration 19: Online help screen for 'Administration of Participants' business package.

Position No.	Description
1	Structure tree showing the table of contents, providing access to all handbook sections
2	Clickable breadcrumb
3	<i>Index</i> button leading to the online help index
4	<i>Table of contents</i> button leading to the online help table of contents
5	<i>Home</i> button leading to online help welcome screen
6	<i>Help</i> screen content

1.3 Overview of the Graphical User Interface for CoCo GUI

The following sections refers to CRDM but the same structure can be considered valid for other common components.

The GUI is a browser-based application for communication with CRDM in U2A mode. It is based on the ISO norm 9241 'Ergonomics of human system interaction'.

1.3.1 Setup and Login Procedures

Before entering the GUI, make sure that your workstation complies with the hardware and software requirements and implement all necessary preparations (e.g. firewall settings) described below.

Such requirements/preparations may be subject to periodical review/update to comply with changing technical/regulatory scenario.

Common components are accessed entering the ESMIG Portal and selecting the proper common components under the service T2S.

Hardware Requirements

Please refer to ESMIG qualified configurations document.

Software Requirements

Please refer to ESMIG qualified configurations document.

Supported Web-Browsers and Settings

Please refer to ESMIG qualified configurations document.

GUI Access

Users are directed to an initial page named ESMIG portal that ensures proper routing to the web applications the user has been granted to enter.

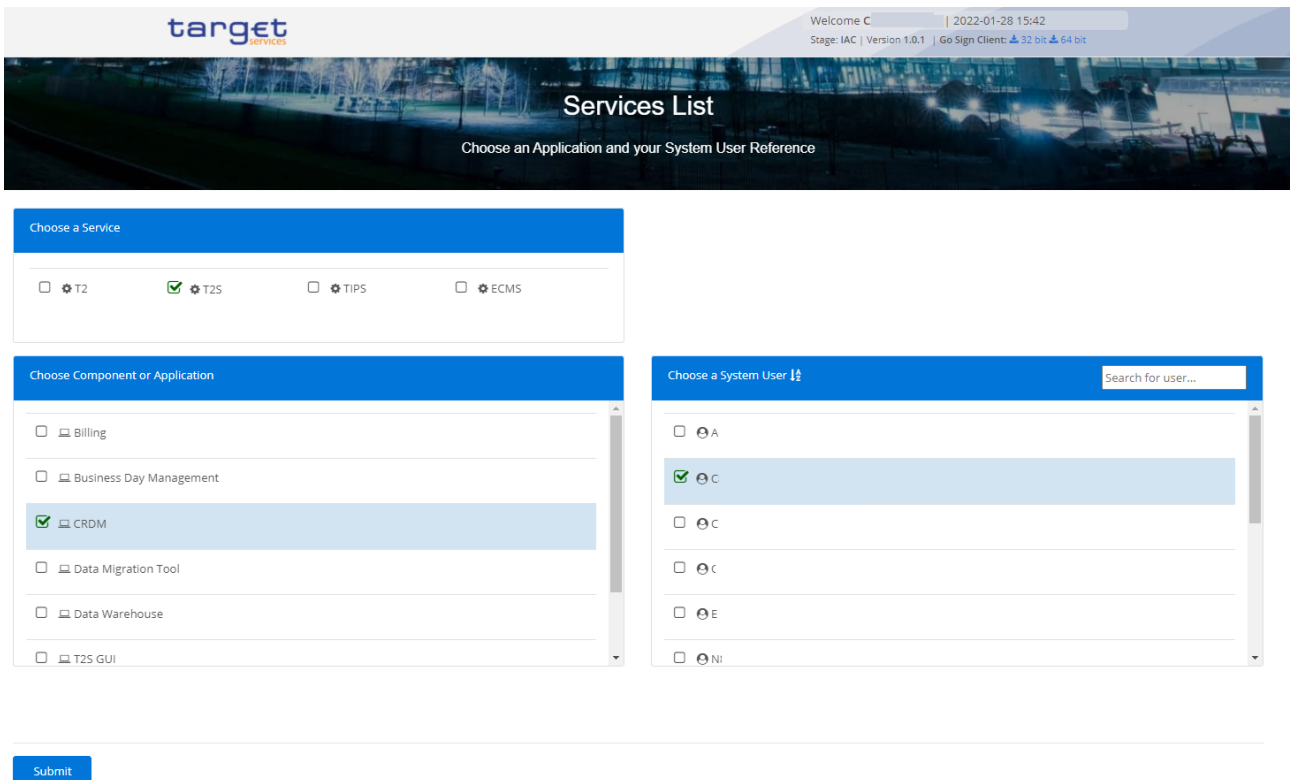

Illustration 20: ESMIG Portal

The ESMIG Portal screen expects the user to select the relevant service to enter.

After the selection of the Service, the user is invited to select a specific component or application.

As a third step, once the component or application is selected, the user is requested to select the System User.

After submitting the screen, the user is redirected to the selected component or application.

In order to properly access the EMIG PORTAL and to select service and components, the user must be granted with the relevant privileges:

- T2S Access: the user granted with this privileges can see “T2S” under “Choose a Service” section and “T2S GUI” under “Choose Component or Application” section.
- CRDM_Access: the user granted with this privileges can see “CRDM” under “Choose Component or Application” section.
- BILL_Access: the user granted with this privileges can see “Billing” under “Choose Component or Application” section.
- BDM_Access: the user granted with this privileges can see “Business Day Management” under “Choose Component or Application” section.
- DMT_Access: the user granted with this privileges can see “Data Migration Tool” under “Choose Component or Application” section.
- TMS_Access: the user granted with this privileges can see “TMS” under “Choose Component or Application” section.
- ORT_Access: the user granted with this privileges can see “Operational Reporting Tools” under “Choose Component or Application” section.

NRO specific requirements

Please refer to ESMIG qualified configurations document.

1.3.2 GUI Structure

This chapter explains the basic elements of the CRDM GUI structure (i.e. structure of the menu and the screens) helping you to navigate through the system and to use it quickly and efficiently.

The first subsection describes the menu structure where screens are grouped hierarchically. Afterwards, the second subsection explains the layout structure common to each screen. The following subsections provide details on the different Screen Types [▶ 60] and on recurring elements, such as common Field Types [▶ 61] or Buttons and Icons [▶ 68].

1.3.2.1 Menu Structure

The GUI menu is structured into four hierarchical menu levels. The hamburger menu appears when the proper icon is selected. After the first level is presented, it is possible to choose the functionalities that are common to the shared services and those that are specific for T2 or TIPS. Then the menu can be further navigated - the second, third and fourth menu levels are accessible via mouse-over on the first-level menu item - in order to select the desired functionality.



Hint

All the menu entries are visible to all users. Anyway, depending on your access rights, it is possible that not all menu entries are available for you. Contact your system administrator to verify that you have the necessary privileges to access all screens relevant to you. The privileges are listed in each screen and business scenario description.

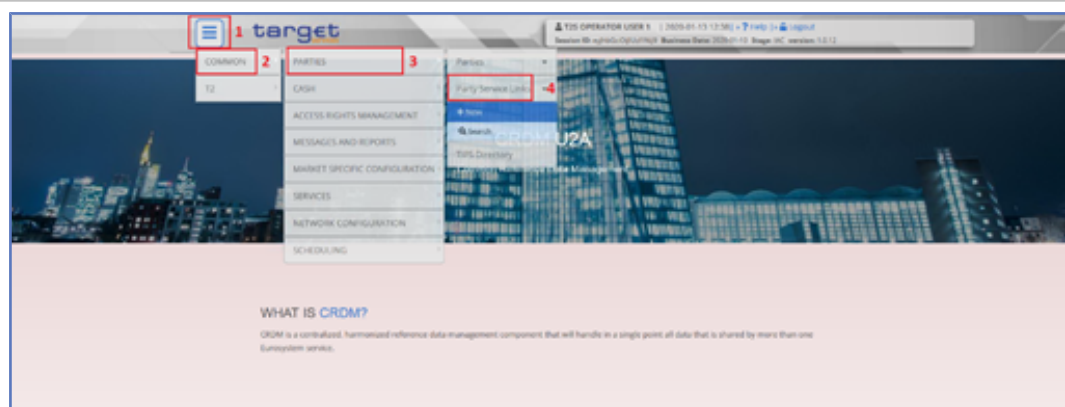

Illustration 21: CRDM menu levels

Position No.	Description
1	Menu level 1
2	Menu level 2
3	Menu level 3
4	Menu level 4

All entries on the third menu level are structural subcategories. To access a screen you have to click on the fourth menu level.

1.3.2.2 Screen Structure

In general, each screen of the CRDM GUI follows the same layout containing a header and a content area.

The header appears at the top of every screen. It contains three main elements providing useful information and helping you to navigate between the different screens as shown in the illustration below.

Header

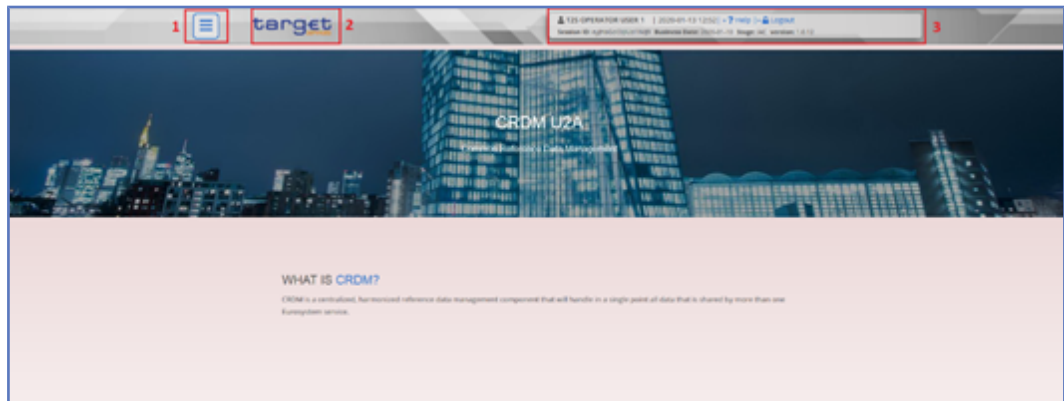

Illustration 22: Header elements

Position No.	Element	Description
1	Menu bar	... presents the main menu item and allows you to navigate to the screens.
2	CRDM logo button	... links to the welcome screen.
3	Information panel	... displays your login name, the logout and help buttons as well as date and time of last data access.

Content Area

The content area is the part of the GUI where you can trigger all business actions. It is organised by five main elements which help you to interact properly with the GUI as shown in the illustration below.

To structure large amounts of data, the content area is further separated into frames and sub-frames.

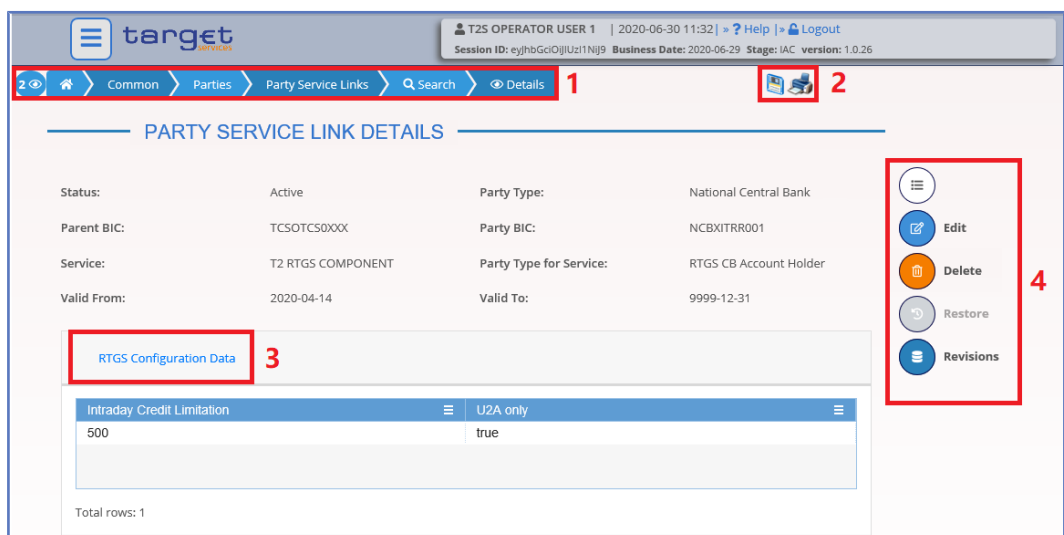

Illustration 23: Content area elements

Position No.	Element	Description
1	Breadcrumb	... shows the main path to the current screen.

Position No.	Element	Description
2	Basic icons	... exports or prints the screen content.
3	Frame and sub-frame title	... groups related information as a structural function.
4	Button bar	... shows all available buttons for the current screen.

Further information about the icons can be found in the common buttons and icons section.

1.3.2.3 Screen Types

The CRDM GUI consists of the following types of screens, each with a different function:

- Welcome screen
- Search/List screen
- Details screen
- Enter screen (usually new or edit screen)

Welcome Screen

Business scenarios are divided into single action steps. These action steps are numbered sequentially. Intermediate results are described where appropriate and marked with an indented arrow. Each business scenario ends with a final result, indicated by an arrow.

Search/List Screen

You can access all search/list screens on menu level four.

The search/list screen allows you to query the CRDM database using a pre-defined set of search criteria. After executing a search, a list of data records matching your search criteria is displayed in a table. To select an entry from a list displayed on a search/list or list screen, click on the desired entry. The background colour of the table line changes to indicate the selected entry. If the search retrieves only one record, the details screen is displayed directly, if you are authorised to access the details screen, else the record is displayed in the table in the list screen. You can browse through the list using the table buttons. Furthermore, it is possible to arrange your search results in ascending or descending order by the columns shown. This does not trigger a refreshed query.

Details Screen

In contrast to the search/list screen, you can only access the details screens via other screens.

All details screens provide you with in-depth information of a previously selected data record.

Before showing the details screen, a new query is forwarded to the system to ensure most up-to-date data.

Enter Screen Similar to the details screens, you can only access the enter screens through other screens.

Enter screens allow you to enter data, which can be done in two enter modes:

- New mode, represented by the new screens
- Edit mode, represented by the edit screens

In general, both modes contain the same fields. In the case of the new mode, all fields are blank. In the case of the edit mode, existing data are prefilled in the fields. In addition, one past value is reported (if available) which cannot be edited. You can edit the existing currently valid value by changing the content of the field. You can only edit an existing currently valid value provided that there is no future value. Otherwise, you need to delete the existing future value beforehand. You can also enter a new future value by clicking on the pencil icon.

1.3.2.4 Field Types and Properties

Field Types The description of the common field types with the proper descriptions follow.

Input Fields In input fields you can enter text and/or numeric content. Make sure to comply with the format requirements, which are part of each field/screen description.

Input-sensitive fields are input fields with an auto-complete mode that helps you to input data. As soon as you start typing the first characters of the respective data into an input-sensitive field, CRDM automatically proposes possible matching entries from which you can select the desired one.

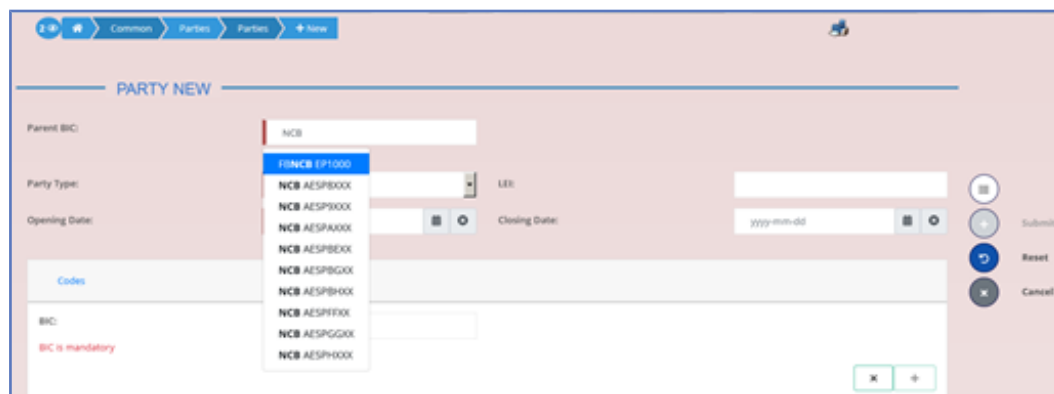

Illustration 24: Input-sensitive field



Hint

You can use the tab key on your keyboard to navigate through the GUI fields.

BIC8 that are entered via GUI are automatically supplemented to BIC11 by adding 'XXX' in order to unambiguously identify a party.

Select Fields Select fields are either select boxes, radio buttons or check boxes.

- **Select boxes:** Functionally a select box is a way to enter data from a limited list of possible values. In CRDM you can find different types of select boxes, standard select box, input-sensitive select box and auto-complete select box.
- **The standard select box** enables the user to choose one entry from a pre-defined set of values. To select an entry, click on the little box with the arrow to open the menu. Then select the desired value by clicking on it.

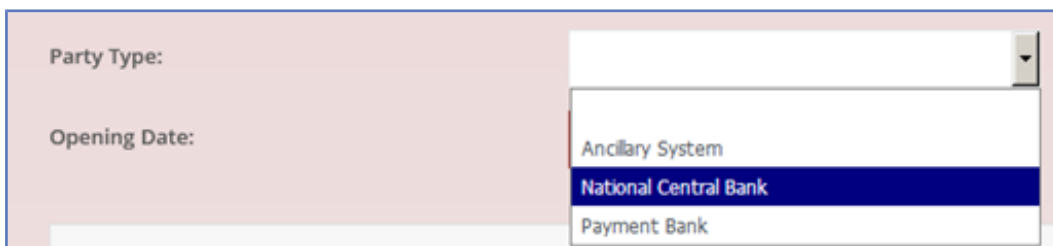

Illustration 25: Standard select box

- **The input-sensitive select box** enables the user to enter the desired value manually, which will be used to reduce the possible set of values in the input-sensitive select box list, which provides you with a drop-down menu that shows the 10 first entries of the set of values irrespective of what you might have entered in the text field.

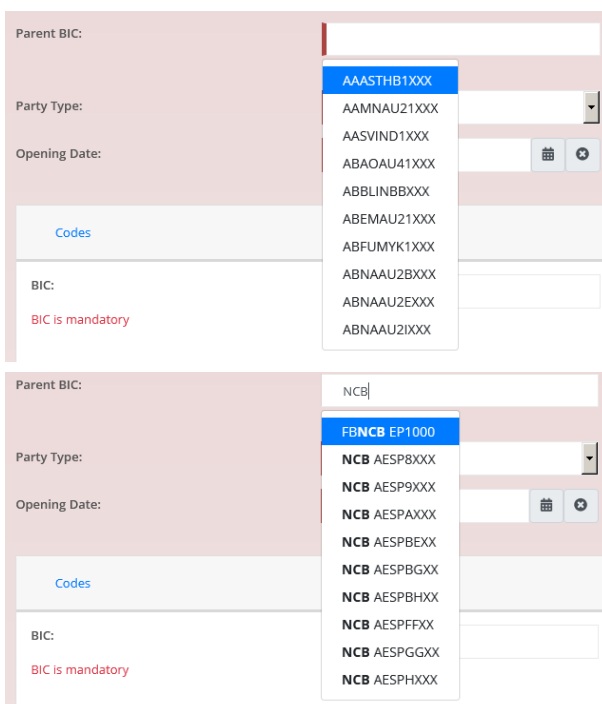

Illustration 26: Input-sensitive select box using the input-sensitive select box icon and input-sensitive select box with manually entered values.

- **The auto-complete select box** enables the user, differently from the input-sensitive select box, to make entries and choose values outside the standard set of values to be sent to the back-end for further validation (extended data scope). Due to that possibility of transporting unqualified data the validation of

the values is restricted to basic checks and will be carried out mainly in the backend. Apart from that, the auto-complete select box functions similar to the input-sensitive select box.



Illustration 27: Auto-complete select box

- Radio buttons:** Enable the user to make exact selections using one value from a set of options. You can select only one value at the same time. Click on the icon corresponding to the option you would like to select.



Illustration 28: Radio buttons

- Check boxes:** Enable you to select more than one value at the same time. Click on the boxes corresponding to the options you would like to select. Selected check boxes contain a check mark.



Illustration 29: Check boxes

Wildcards

A wildcard is a placeholder for characters and it represents any acceptable character or a set of them in a string. In CRDM you can use a wildcard in input fields or google-style fields in all the search screens to search for data widening the result to all the strings matching the pattern. The required number of characters is indicated in the field description. CRDM accepts two possible values:

- '*' that is a placeholder for one or more characters of the input value;
- '?' that is a placeholder for exactly one character of the input value.

Examples

CRDM*: The result list contains all data records beginning with 'CRDM'.

*Account: The result list contains all data records ending with 'Account'.

CRD?: The result list contains all data records that have any acceptable character at the end of 'CRD', e.g. 'CRDM', 'CRDX', etc.

The combination of the wildcard '*' is not possible, e.g. 'CRD?*' or 'CR**'

The wildcards are always usable in the fields reported before with the following restrictions:

- It is possible that to properly search with wildcards you have to insert at least two or four characters. In this case, the minimum number of characters to be entered is reported in the field remarks;
- It is possible that a field does not allow wildcards; in this case, this is explicitly mentioned in the Remarks field.

Read-only Fields

In addition to enter and select fields, the CRDM GUI has also read-only fields, which are pre-filled and do not allow data changes.

Field Properties

All field types have specific properties with respect to possible character sets, and mandatory content.

Date

A Date type field has the following format: YYYY-MM-DD. There are four digits representing the year, two digits representing the month and two digits representing the day.

The default value of Date fields, unless differently specified, is BLANK.

Generally, if a closing date value is not specified, the system will automatically set the date "9999-12-31".

The field Date is always linked to a calendar icon that opens a calendar where you can select a day. It is possible to insert a date writing in the field or using the calendar.

Time ¹

The Time type field has the following format: HH:MM. There are two digits representing the hour and two digits representing the minute.

DateTime ²

A DateTime type field has the following format: YYYY-MM-DD HH:MM. There are four digits representing the year, two digits representing the month, two digits representing the day, two digits representing the hour and two digits representing the minute. The field DateTime is always linked to a calendar icon that opens a calendar where you can select a day. It is possible to insert a date writing in the field or using the calendar.

Amount

The GUI will show the amounts with all decimal points, English Format (the decimal separator will be a "." and the thousand separator is ",") and right alignment.

1 The Time in the system refers to the CET/CEST zone.

2 The Time in the system refers to the CET/CEST zone.

Amounts can be entered up to 18 figures, that is maximum 19 characters if the decimal separator is present.

When the amount field is in read-only mode or the amount field is not selected for typing, the amount shows the thousand separator.

When the user is typing the numbers, the amount is shown without the thousand separators.

The amount fields should allow shortcuts:

- enter "Xm" and the system will transfer this automatically into X,000,000.00[.00]
- enter "Yt" and automatically translated into Y,000[.00].

The number of decimals is defined by the currency.

Negative amounts (shown by the system but not entered by the user) are written in red and marked with a "-" (This rule applies for all negative values).

According to the character set, only numerical characters (decimal – abbreviation "d") can be used for amounts plus the negative symbol.

Field	Description	Validation	Error Code
Amounts	Contains an Amount.	The Amount must be greater than or equal to 0.	The amount must be greater than or equal to 0.
Amounts	Number of Decimals of an amount	The Amount must have <number of decimals stored for the currency> decimals.	Wrong format in field <field name>. The correct format has to be xxx.xxx,<number of decimals stored for the currency>.
Amounts	Character set to be used	It is only possible to use a numerical character set.	Only numerical characters are allowed

Numeric

There are different type of numeric field. In general these fields, in edit mode, can contain only numbers and "-" symbol.

Field	Description	Edit mode	New mode
Numeric	Can contain only natural numbers (positive integer).	Only numbers are allowed.	The thousand separator is shown.
Integer	Can contain positive and negative integer values.	Numbers and char "-" are allowed.	The thousand separator is shown. When negative, the char "-" is shown and the string is in red.

Field	Description	Edit mode	New mode
Positive Real	Can contain positive values with decimals. When using this type, the number of decimal must be specified.	Numbers and decimal separator are allowed.	The thousand and decimal separators are shown.
Real	Can contain positive and negative values with decimals. When using this type, the number of decimal must be specified.	Numbers, decimal separator and char “-“ are allowed.	The thousand and decimal separators are shown. When negative, the char “-“ is shown and the string is in red.
Percentage	Can contain positive values with decimals. When using this type, a maximum of 5 digit(s) including decimal point (thereof max. 2 decimal places and decimal point) are allowed.	Numbers and decimal separator are allowed.	The thousand and decimal separators are shown plus “%” symbol.
Percentage + negative	Can contain positive and negative values with decimals. When using this type, the number of decimal must be specified.	Numbers, decimal separator and char “-“ are allowed.	The thousand and decimal separators are shown plus “%” symbol. When negative, the char “-“ is shown and the string is in red.
Telephone Number	Shall contain numbers from 0 to 9 and chars “+”, “-“, “(“, “)“.	Numbers and chars “+”, “-“, “(“, “)” are allowed.	The chars “+”, “-“, “(“, “)” are shown (e.g. ‘+012-3456789’).

Field	Description	Edit mode	New mode
	<p>When using this type, the following pattern shall be respected:</p> <p>Starting with “+”</p> <p>Then at least one to maximum three digits</p> <p>Then symbol “-“</p> <p>Then at least one to maximum thirty characters (digits and symbols “+”, “-“, “(“, ”)“ are allowed).</p>		

Characters

CRDM operates in British English and uses the SWIFT-x character set to enter data: if not described differently, the fields are intended to be based on the SWIFT-x character set. CRDM can accept the UTF-8 character set with the exception of '<', '>' and '&' in specific fields; when this happens, this is explicitly reported.

The GUI does not differentiate between upper and lower case in terms of data input for input fields.

The SWIFT-x character set corresponds with the following content:

Character	Description
a - z	26 small characters of the Latin alphabet
A - Z	26 capital characters of the Latin alphabet
0 - 9	10 numeric characters
/	Solidus (slash)
-	Hyphen
?	Question mark
:	Colon
(Opening parenthesis
)	Closing parenthesis
.	Full stop
,	Comma

Character	Description
'	Apostrophe
+	Plus
	Space (blank)
CR	Carriage return
LF	Line feed



Hint

CRDM does not process fields (mandatory or optional), that are only filled with blanks. Blanks appearing at the beginning or at the end of a field entry are deleted automatically without any notification.

Fields in a list or details screen, where the dataset was saved without an entry, are filled with '---'.

Mandatory Content

In the GUI all mandatory fields are marked with a red line in the label. All marked fields have to be filled in before you are allowed to proceed. The red line is turned into green when the field contains a value or is selected.

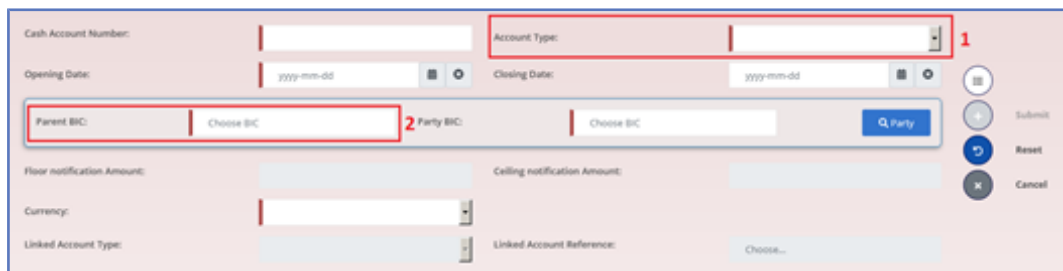

Illustration 30: Mandatory fields

Position No.	Description
1	Mandatory select field
2	Mandatory input field

1.3.2.5 Common Buttons and Icons

While working with the CRDM GUI you will find that some buttons and icons appear regularly. There are three types of common elements:

- Basic icons, which you can find on every screen
- Utility elements, which represent functions within the content area
- Table elements, which you can find below data record lists on search/list

The buttons contained in the button bar are variable and therefore explained in the screen descriptions.

Basic Icons



Illustration 31: Basic icons

Position No.	Element	Description
1	Export icon	<p>... exports the data of the executed query from the current screen into a csv-file.</p> <p>If exporting a list, the related search criteria are exported as well whereas detailed data are only exported, if the respective list and the details screen are covered by the same query. Otherwise just the list entry will be exported.</p> <p>The export icon is common to all CRDM screens except for the welcome and the new screens.</p> <p>In addition to the exported data from the screen the following information is exported at the start of the file: name of the exported screen (including menu path), current date, name of the user who triggered the exporting, classification label 'RESTRICTED', timestamp of the export, defined search criteria (query parameters, if applicable), 'CHANGED DATA' when exporting an edit screen which contains amended data that has not been submitted yet.</p>
2	Print icon	<p>... prints the data of the current screen.</p> <p>It is strongly recommended to use this button for generating a clearly arranged overview of data on the printout.</p> <p>The print icon is common to all CRDM screens except for the welcome screen.</p>

Utility Elements

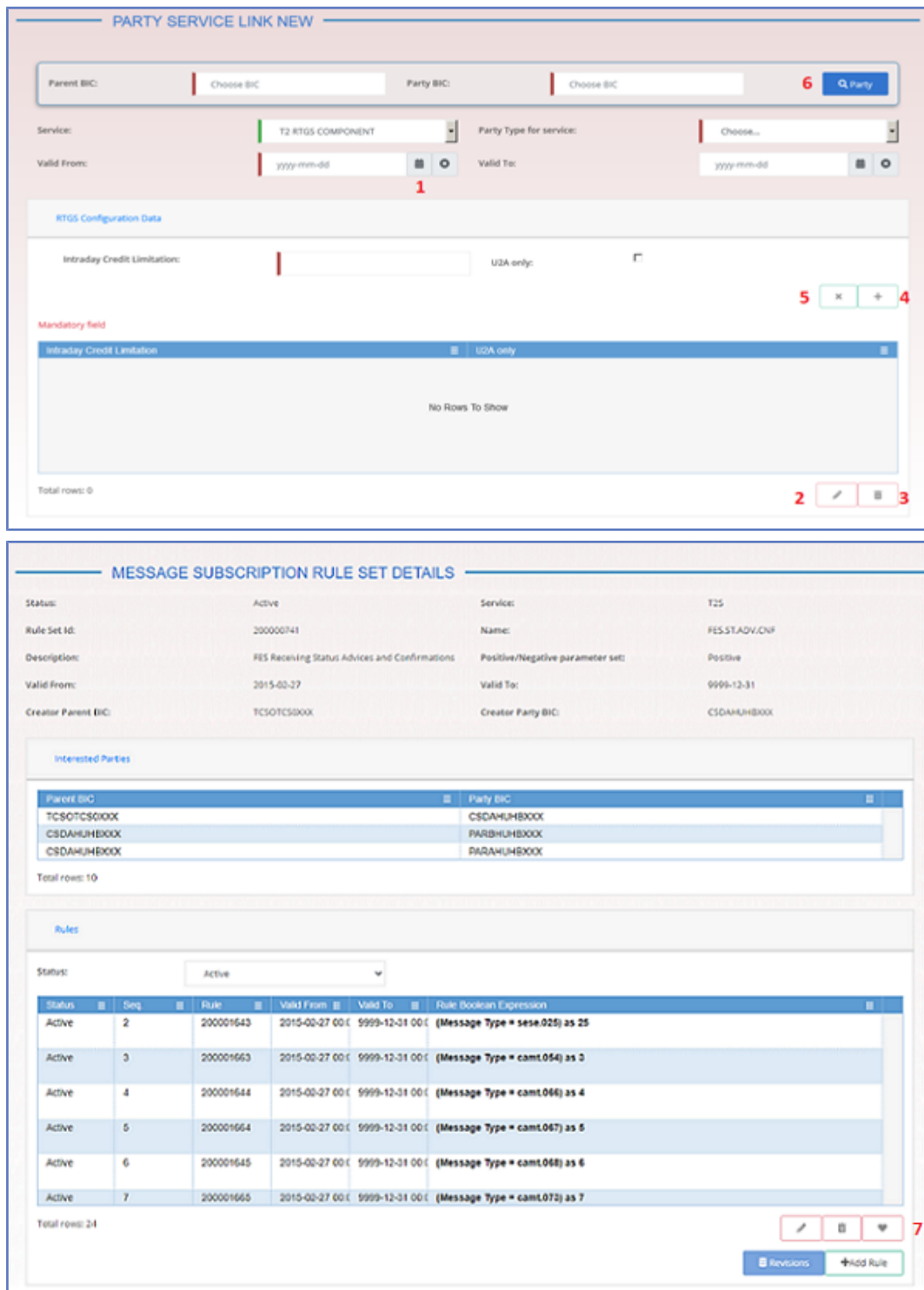

Illustration 32: Utility Elements

Position No.	Element	Description
1	Calendar icon	... opens a calendar where you can select a day. If applicable, you can also select the time via the calendar icon.

Position No.	Element	Description
2	Pencil icon	<p>... enables you to enter a new future value into an input field.</p> <p>In edit mode, you can either change an existing data record or enter a new future one. If you have changed the existing current value before entering a future one, the data are restored.</p> <p>The pencil icon is only available on edit screens.</p>
3	Delete row icon	<p>... removes the selected row in the corresponding list as well as fields or sub-frames.</p> <p>The delete row icon is only available on new and edit screens.</p>
4	Submit changes icon	<p>... updates the selected row in the corresponding list using the values inserted in the related fields.</p> <p>The submit changes icon is only available on new and edit screens.</p>
5	Cancel changes icon	<p>... enables you to leave the selected and edited row without causing any changes.</p> <p>The cancel changes icon is only available on new and edit screens.</p>
6	Magnifier icon	<p>... provides the possibility to search for data on other screens.</p> <p>If you are not aware of the exact/correct value, but you know other related data, click on the magnifier icon to enter the search screen. There you can enter all information known to you and execute a search. By clicking on the select button, you are redirected to the initial screen with the desired data entered in the respective fields.</p> <p>The attribute equipped with magnifier icon works otherwise like an auto-complete select box.</p>

Position No.	Element	Description
7	Heart icon, Restore row icon	... restores the selected row in the corresponding list or sub-frames. The Heart icon is only available on lists or sub-frames.

Table Elements

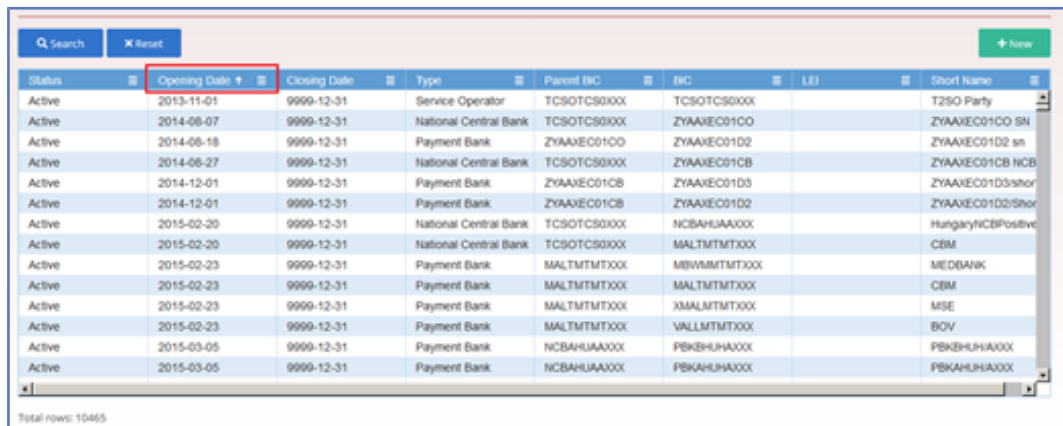

Illustration 33: Table Elements – Sort icon

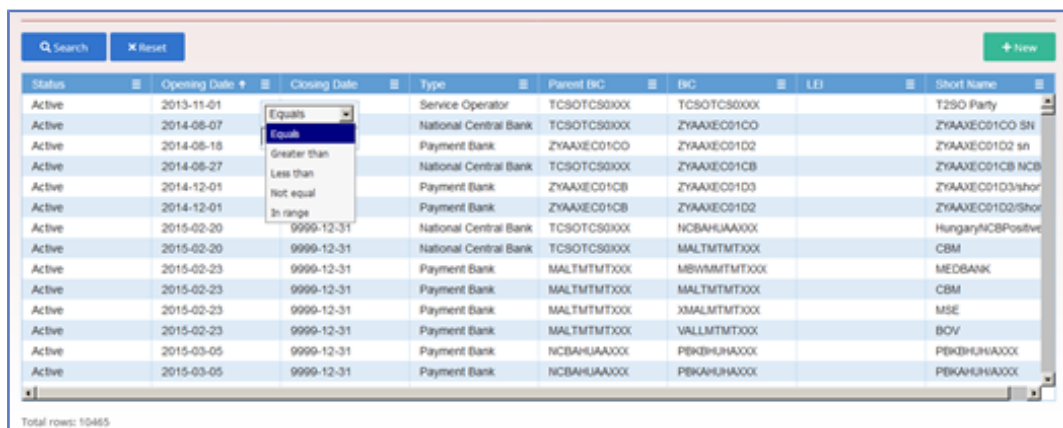
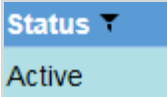

Illustration 34: Table Elements - Supplementary filters in list objects

Position No.	Element	Description
1	Sort icon	... sorts the list in ascending or descending order by clicking on the up or down arrow.
2	Supplementary filter	... allows in-memory filtering, depending on the type of fields, of the displayed list of items according to additional criteria as shown below. Data fields supplementary filter criteria: <input type="checkbox"/> Equals <input type="checkbox"/> Greater than <input type="checkbox"/> Less than

Position No.	Element	Description
		<p><input type="checkbox"/> Not equal</p> <p><input type="checkbox"/> In range</p> <p>Text fields supplementary filter criteria:</p> <p><input type="checkbox"/> Equals</p> <p><input type="checkbox"/> Not equal</p> <p><input type="checkbox"/> Starts with</p> <p><input type="checkbox"/> Ends with</p> <p><input type="checkbox"/> Contains</p> <p><input type="checkbox"/> Not contains</p> <p>Predefined supplementary filter criteria:</p> <p>It contains an adaptive list of values which is consistent with the related search criterion. E.g. for any Status field, the predefined supplementary filter contains the following values: 'All', 'Active', 'Deleted'.</p> <p>When a supplementary filter criterion is used, the list is automatically filtered in memory without submitting the query to the back-end. When applied, any supplementary filter can be removed by individually resetting the corresponding filter.</p> <p>If a supplementary filter is applied, a small icon near the column header is displayed, as shown in the following image.</p> 

1.3.3 Validation

In CRDM, all submission processes undergo various validations, which take place in the front-end and/or in the back-end. Only correct entries, fulfilling all predefined criteria, can be further processed. To indicate the status of the recently performed action, CRDM uses two different types of messages to indicate a successful or failed validation as described below.

In addition to the automatic validation carried out by CRDM, human validation can be imposed by using the 4-eyes mode.

Furthermore, non-repudiation of origin (NRO) is implemented for a specified number of screens.

Front-End Validation

As first part of the validation process, the front-end validation takes place without communication to the back-end. The front-end validation includes both the field validation and the cross-field validation. It is carried out after clicking on a button.

The field validation verifies that all entries comply with the required format.

The cross-field validation checks the data consistency between two or more fields/buttons in relation to each other.

Back-End Validation

The back-end validation is the second part of the validation process. After successful front-end validation, your request is submitted to the back-end and checked for compliance with the business validation rules. In case of failure an error message is displayed. You can find a detailed list of all error messages and their description in the annex of the UHB (List of References for Error Messages [► 1251]).

Result

After each validation, the CRDM GUI informs you about the result. There are two different message types available, the error message and the success message.

Error Message

Each error message appears as a pop-up on the upper right corner of the screen. In the case of a failed front-end or back-end validation, it indicates the source of the failure, the type of error and a short hint.



Illustration 35: Error message

Success Message

The success message appears as a pop-up on the upper right corner of the screen. It confirms that your data have been submitted successfully.

If you are working in 4-eyes mode, the success message also provides you with the 4-eyes principle ID.

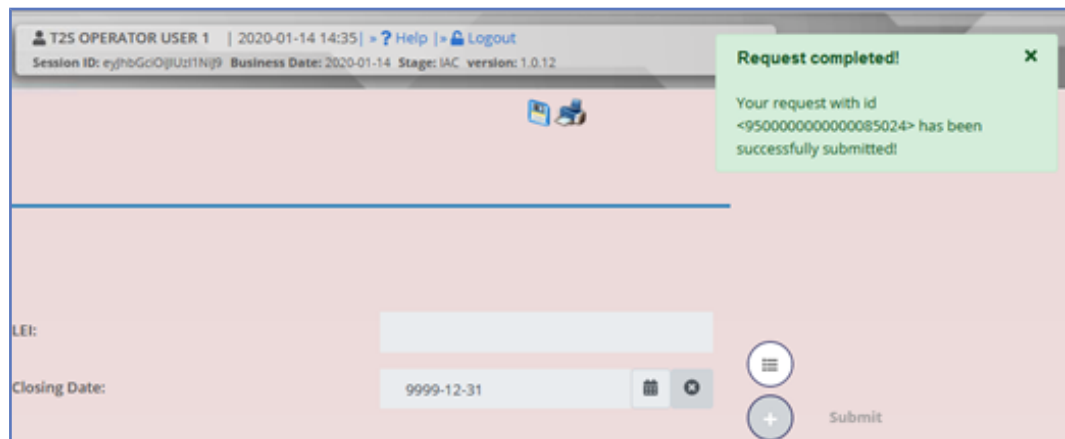

Illustration 36: Success message

4-Eyes Mode Depending on the access rights setup, you can use CRDM in 2-eyes or in 4-eyes mode. The 2-eyes mode and the 4-eyes mode apply for enter screens (new and edit mode) and for any kind of deletion processes. If you are a 4-eyes mode user, your actions have to be confirmed by a second user in order to be processed.

First User In 4-eyes mode the first user enters, changes or deletes the data on a screen and afterwards submits the action by clicking on the submit button in the button bar. The success message appearing after successful validation includes a 4-eyes principle ID. For the final execution a second user is needed to confirm the action.

Second User After the first user has entered, changed or deleted the data, a second user (with the required privilege) has to approve or revoke this action via the data changes screen either using the 4-eyes mode ID or the search functionality.

As soon as the data changes are positively approved, CRDM marks these data as approved and they are forwarded to further processing.

Digital Signature For further information refer to chapter Digital Signature (NRO).

NRO

1.3.4 Communication Network and Services

Refer to the ESMIG UDFS document for details on the communication network and services.

1.3.5 User Administration

Registration Only registered users have access to the CRDM GUI, therefore registration in CRDM reference data and to the network is necessary prior to the first GUI access. The Registration Guide provides information on how to fill in Registration Forms properly.

After registration the system administrator is given the possibility to grant and revoke privileges to its users within the CRDM GUI as described in both the screen reference part and the user instructions part.

1.3.6 Security and Certification Services

In order to guarantee a secure and safe handling of the information and to protect customer data provided via the GUI, various security elements have been put into place:

- Each action requires System or human validation as described in the Validation [▶ 73]
- The scope of available data and functions is controlled via the management of access rights
- The security features provided by the network providers and described in their respective user documentation prevent unauthorised access

1.3.7 Online Help

The content of the UHB can be accessed from the CRDM GUI by clicking on the help button.

2 Screen Reference Part

2.1 General

The screen reference part offers a complete overview of all T2S GUI screens that are available in U2A mode. Each screen description focuses on a single screen and explains all fields contained therein. An exception is made for the *new* and *edit* screens, which are largely similar and therefore included in a single screen description. The description is always based on and contains only the screenshot of the *edit* screen, but describes deviations for the *new* screen in a separate row for each field or button description.

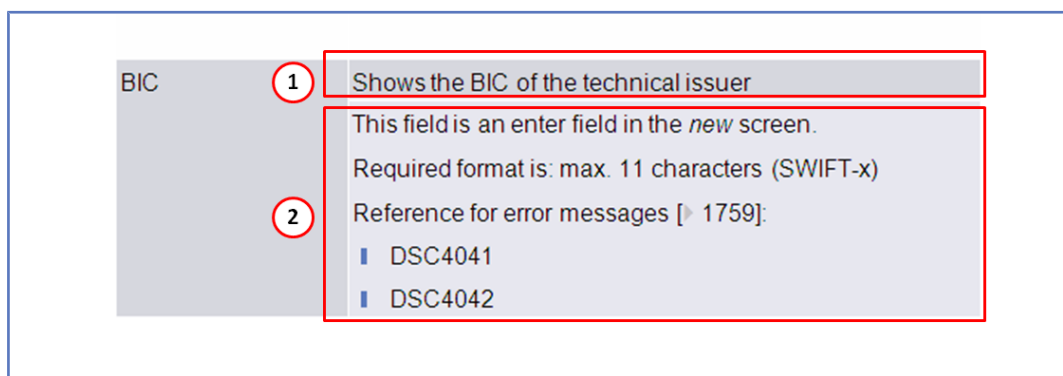

Illustration 37: Example of a *new* and *edit* screen description

Position No.	Element
1	Description relevant for <i>edit</i> mode.
2	Description relevant for <i>new</i> mode.

In detail, every screen description has the same structure and contains the following elements.

Context of Usage

The context of usage explains what a screen displays, what you can do with the screen and which special features are available for the screen, for example the need for confirmation in 4-eyes mode or usage restrictions. If the export functionality produces more data than shown on the screen (if a *list* screen is based on a detailed query), this is also indicated in the context of usage.

Screen Access

The screen access lists all possible ways to access the screen. This includes navigation via the menu and navigation via other screens.



Examples

Navigation via the menu:

Common >> Cash >> Cash Accounts >> Search

Navigation via other screens:

Common >> Parties >> Parties >> *Parties – search/list* screen >> Click on the *search* and *details* button >> Click on the *cash accounts* button

When navigating via a *search/list* or *list* screens, a data record has to be selected by clicking on a table row. Afterwards, you can click on specific buttons in the button bar, e.g. the *edit* or *details* button.

Privileges

The privileges segment lists all necessary privileges to access the screens and to use its functions. First, the privileges to access a screen are mentioned, followed by the privileges that are necessary to use all functions on the screen.

For further information, refer to the list of privileges.

References

The first reference lists all business scenarios containing the respective screen (reference to the user instructions part). The second reference indicates the business functions related to the respective screen (reference to GUI Business Functionalities Document).

Screenshot

You can use the screenshot as orientation for your work with the UHB. All screenshots are based on the maximum of access rights, so deviations are possible if you do not own all privileges which are necessary to use the screen in its full extent. In addition, deviations between the screenshot and the field/button description are possible in the case of mutually exclusive functions and based on a specific selection you have made. Values shown on the screenshot might also deviate from the default values indicated in the description.

In the case of the *new/edit* screen description, the screenshot of the *edit* screen is used. Differences appearing in the *new* screen are explained in the field description.

Field

Description

The field description provides all the relevant information related to the respective field name. It is structured in table format with a separate table for each frame. Subframes are indicated by subsection headings in the table. The following illustration explains the structure of a field description.

Field	2 Amendment Instruction	
Description	3 Referenced Instruction	
1 Instructing Party BIC	4	Enter the BIC of the instructing party for the instruction to be linked to.
	5	Required format is: max. 11 characters (SWIFT-x)
	6	If the "T2S Reference" field is not filled in, this field is mandatory.
	7	Reference for error message: [1392] <ul style="list-style-type: none"> ■ MVDC026 ■ MVCV107 ■ MVCV232
	8	This field is only available, if the referenced instruction is a settlement instruction.

Illustration 38: Example of a screen description

Position No.	Element	Description
1	Field name	... indicates the respective name of each screen field. Mandatory fields are marked with an asterisk after the field name. In the case of the <i>new/edit</i> screen description, the mandatory field is marked with an asterisk in brackets, which indicates that the respective field is either mandatory in the edit or in the new mode. Input and select fields without an asterisk are always optional.
2	Frame name	... indicates the respective name of each screen frame.
3	Sub-frame name	... indicates the respective name of each screen sub-frame.
4	Field description	... indicates the field type and required content. Each field description starts with a keyword, which illustrates your required activity: <input type="checkbox"/> 'Shows...' indicates a read-only field [37] <input type="checkbox"/> 'Select...' indicates a select field [▶ 37]

Position No.	Element	Description
		<ul style="list-style-type: none"> □ 'Enter...' indicates an input field [▶ 37] <p>If there is an exhaustive list of possible values, these are listed.</p>
5	Required/Displayed format	<p>... indicates all field format requirements related to the fields. If there is more than 1 format requirement, they are separated with a comma.</p> <p>In read-only fields the displayed format is only mentioned, if the field content is ambiguous. This applies especially to date fields.</p> <p>The following keywords are used for the format requirements:</p> <ul style="list-style-type: none"> □ 'Digit' indicates numbers □ 'Character' indicates a character from the SWIFT-x character set [▶ 37] □ 'Letter' indicates upper and lower case letters of the Latin alphabet
6	Cross-field validations	<p>... indicate interdependencies between fields relevant for the validation of your input.</p> <p>For further details on the validation process, refer to validation [▶ 49].</p>
7	References for error message	<p>... indicates the code of all possible errors applying to the field during the back-end validation. The corresponding error text and error description is listed in the annex (list of references for error messages [▶ 1251]).</p> <p>For further details on the validation process, refer to validation [▶ 49].</p>
8	Additional information	<p>... section indicates the useful information that is for filling in the field.</p>

Buttons

All buttons specific to the screen are listed and described in a table at the end of the screen description. The following illustration explains the structure of a button description.

Buttons

1	Search	<p>2 This function enables you to start a search according to the criteria entered. The results are displayed in a list on the same screen.</p> <p>3 Next screen: <ul style="list-style-type: none"> ■ Roles – search/list screen </p> <p>4 If the deletion status of the selected role is already set to “Active”, this function is not available.</p> <p>5 Reference for error messages: [▶ 1702] <ul style="list-style-type: none"> ■ DRR6001 ■ DRR6002 </p> <p>6 If you have accessed this screen via another screen, this function is not available.</p>
----------	--------	--

Illustration 39: Example of a button description

Position No.	Element	Description
1	Button name	... indicates the respective name of each button.
2	Button description	... indicates the action that is triggered when clicking on the button. Each button description starts with ‘This function enables you...’
3	Next screen	... element lists the screen which is displayed after clicking on a button. If there are various possible next screens depending on your previous actions, all of them are listed.
4	Cross-field validations	... indicate interdependencies between a field and the button relevant for the validation of your input. For further details on the validation process, refer to validation [▶ 49].
5	References for error messages	... indicates the code of all possible errors applying to the button during the back-end validation. The corresponding error text and error description is listed in the annex (list of references for error messages [▶ 1251]).

Position No.	Element	Description
		For further details on the validation process, refer to validation [▶ 49].
6	Additional information	... section indicates useful information regarding the button and/or its function.

For further information on common buttons, refer to Common Buttons and Icons [▶ 43].

2.2 Securities

2.2.1 Securities Account

2.2.1.1 Securities Positions - Search/List Screen

See *Securities Positions – Search/List Screen* [▶ 169].

2.2.1.2 Securities Position - Details Screen

See *Securities Positions – Details Screen* [▶ 174].

2.2.1.3 Securities Postings - Search/List Screen

Context of Usage

This screen contains a number of search fields. By inputting the relevant data, you can search for securities postings, which are the individual debits and credits impacting the selected securities positions. The search results are displayed in a list, which is sorted by the values of the 'Securities Account Number' column in ascending order (default setting). After selecting an entry, you can proceed further by clicking the buttons below.

This screen is not relevant for CB users.

Screen Access

- Securities >> Securities Account >> Securities Postings
- Securities >> Securities Account >> Securities Positions >> *Securities positions – search/list* screen >> Click on the *search* and/or *details* button >> *Securities position - details* screen >> Click on the *postings* button
- Securities >> Settlement >> Securities Positions >> *Securities positions – search/list* screen >> Click on the *search* and/or *details* button >> *Securities position - details* screen >> Click on the *postings* button
- Monitoring >> Monitoring >> Securities Positions >> *Securities positions – search/list* screen >> Click on the *search* and/or *details* button >> *Securities position - details* screen >> Click on the *postings* button

- Securities >> Settlement >> Intra-position Movements >> *Intra-position movement – details* screen >> Click on the *securities position details* button >> >> *Securities position - details* screen >> Click on the *postings* button

Privileges

To use this screen, you need the following privilege [▶ 1227]:

- Securities posting query

References

User Instructions Part

This screen is part of the following business scenario:

- View current securities positions and related postings [▶ 722]

Business Functionality Document

This screen corresponds to the following business functions:

- Query securities account postings (T2S.GUI.SESE.POS.0030)
- Display securities account postings (T2S.GUI.SESE.POS.0040)

Screenshot

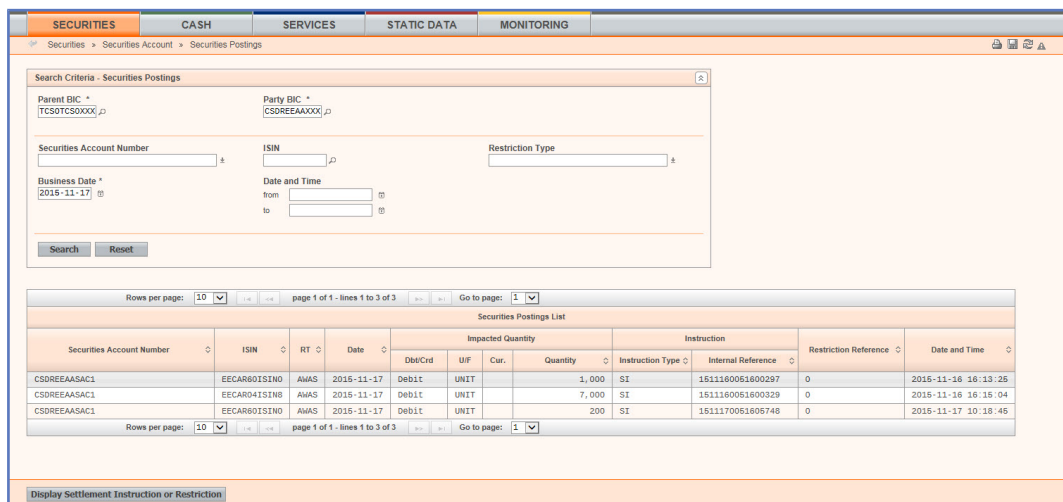

Illustration 40: Securities postings – search/list screen

Field

Description

Securities Postings – Search Criteria	
Parent BIC*	Select the BIC of the CSD from the drop-down menu. Required format is: max. 11 characters (SWIFT-x) If you have accessed this screen via the securities positions – details screen, this field is already filled in.
Party BIC*	Select the BIC of the party from the drop-down menu. Required format is: max. 11 characters (SWIFT-x) If you have accessed this screen via the securities positions – details screen, this field is already filled in.
Securities Account Number	Select the number of the securities account from the drop-down menu.

Securities Postings – Search Criteria	
	<p>Required format is: max. 35 characters (SWIFT-x)</p> <p>No default value but filled if only one account possible.</p> <p>If you have accessed this screen via the securities positions – details screen, this field is already filled in.</p> <p>Reference for error message:</p> <p><input type="checkbox"/> QMPC030</p>
ISIN	<p>Enter the ISIN of the security.</p> <p>Required format is: 12 characters (SWIFT-x)</p> <p>Must be a valid existing ISIN.</p> <p>If you have accessed this screen via the securities positions – details screen, this field is already filled in.</p>
Restriction Type	<p>Select the restriction type from the drop-down menu.</p> <p>Required format is: max. 4 characters (SWIFT-x)</p> <p>Value 'All' defined as postings of all securities positions.</p> <p>If you have accessed this screen via the securities positions – details screen, this field is already filled in.</p>
Date	<p>Enter the date of the securities postings or use the <i>calendar</i> icon.</p> <p>Required format is: YYYY-MM-DD</p> <p>The default value is the current business day.</p> <p>This date must be a valid business date earlier than or equal to the current business date.</p> <p>If you have accessed this screen via the securities positions – details screen, this field is already filled in.</p>
Date and Time from	<p>Enter the starting date and time of the securities postings or use the <i>calendar</i> icon.</p> <p>Required format is: YYYY-MM-DD HH:MM</p> <p>This date and time must be a valid business date earlier than or equal to the current business date and time.</p>
Date and Time to	<p>Enter the ending date and time of the securities postings or use the <i>calendar</i> icon.</p> <p>Required format is: YYYY-MM-DD HH:MM</p>

Securities Postings – Search Criteria	
	This date and time must be a valid business date earlier than or equal to the current business date and time. The date and time must be equal or later than the 'Date and Time From'.
Securities Postings - List	
Securities Account Number	Shows the number of the securities account of the securities posting. Reference for error message: <input type="checkbox"/> QMPC030
ISIN	Shows the ISIN of the security.
Restriction Type	Shows the restriction type of the securities posting.
Date	Shows the date of the last movement of the securities posting. Displayed format is: YYYY-MM-DD
Quantity Impacted	
Debit/Credit Indicator	Shows the debit credit indicator related to the securities posting from one of the possible values: <input type="checkbox"/> D (for debit) <input type="checkbox"/> C (for credit)
Settlement Type	Shows the quantity type related to the securities posting from one of the possible values: <input type="checkbox"/> U (for unit) <input type="checkbox"/> F (for face amount)
Currency	Shows the issuance currency of the security related to the securities posting. Provided only when quantity of securities is given as a face amount.
Quantity	Shows the quantity of the securities posting.
Instruction	
Instruction Type	Shows the type of instruction related to the securities posting from the possible values: <input type="checkbox"/> SI (for settlement instruction) <input type="checkbox"/> SR (for settlement restriction)
Internal Reference	Shows the identification of the T2S internal reference of the instruction related to the securities posting.

Securities Postings – Search Criteria	
Restriction Reference	Shows the identification of the restriction reference related to the securities posting.
Date and Time	Shows the date and time of the securities posting. Displayed format is: YYYY-MM-DD hh:mm:ss:µsµsµsµsµs

Buttons

Buttons	
Search	This function enables you to start a search according to the criteria entered. The results are displayed in a list on the same screen. Next screen: <input type="checkbox"/> <i>Securities postings – search/list</i> screen Reference for error message: <input type="checkbox"/> QMPC030
Reset	This function enables you to set default search criteria and blanks out all optional criteria. Next screen: <input type="checkbox"/> <i>Securities postings – search/list</i> screen
Display Settlement Instruction or Restriction	This function enables you to display the details of the securities instruction or restriction for the selected row. Next screen: <input type="checkbox"/> <i>Settlement instruction - details</i> screen [▶ 192] <input type="checkbox"/> <i>Intra-position movement – details</i> screen [▶ 144]

2.2.1.4 Securities Restriction Details - Search/List Screen

Context of Usage

This screen contains a number of search fields. By inputting the relevant data, you can search for securities restrictions which are sub positions reserved, blocked or earmarked for specific purpose. The search results will be displayed in a list, which is sorted by the value of the ‘Securities Account Number’ column in ascending order (default setting). After selecting an entry, you can further proceed by clicking on the buttons below.

During the Start of Day, when the CRDM data is being replicated in the Settlement domain, only the securities restrictions data available at the End-of-Day of the previous business day is displayed on the screen. The securities restrictions data for the new business day is available as of the end of the CRDM data replication.{CR-634}

During night-time, the securities restriction details can only be displayed in-between night-time settlement sequences.

This screen is not relevant for CB users.

Screen Access

- Securities >> Securities Account >> Securities Restriction
- Securities >> Securities Account >> Securities Positions >> *Securities positions – search/list* screen >> Click on the *search* and/or *details* button >> *Securities position - details* screen >> Click on the *restriction reference* button

Privileges

To use this screen, you need the following privilege [▶ 1228]:

- Securities position detailed restriction details query

References

User Instructions Part

This screen is part of the following business scenario:

- View current securities positions and related restrictions [▶ 723]

Business Functionality Document

This screen corresponds to the following business functions:

- Display securities account positions (T2S.GUI.SESE.POS.0020)
- Query securities account positions – current and history (T2S.GUI.SESE.POS.0010)

Screenshot

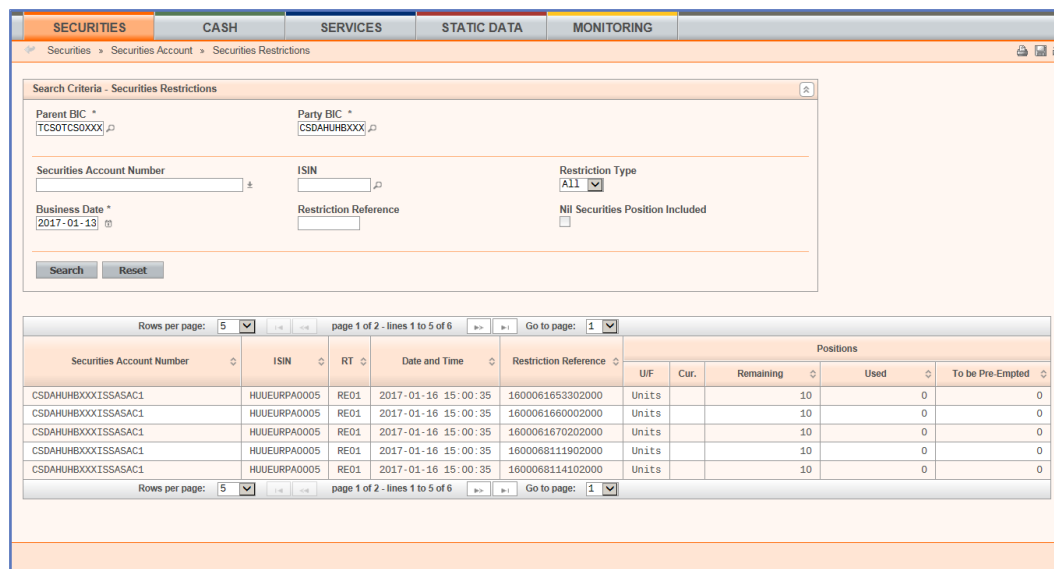

Illustration 41: Securities restriction details – search/list screen

Field Description

Securities Restriction Details – Search Criteria	
Party BIC*	Select the BIC of the party from the drop-down menu or search via the <i>magnifier</i> icon. Reference for error message:

Securities Restriction Details – Search Criteria	
	<input type="checkbox"/> QMPC032
Parent BIC*	Select the parent BIC of the party from the drop-down menu. Reference for error message: <input type="checkbox"/> QMPC048
Securities Account Number	Select the number of the securities account from the drop-down menu. This field is already filled in, if there is only one possible account. Reference for error message: <input type="checkbox"/> QMPC030
ISIN	Enter the ISIN of the security. Required format is: max. 12 characters (SWIFT-x)
Restriction Type	Select the restriction type from the drop-down menu. The default value is 'All'. Reference for error message: <input type="checkbox"/> QMPC091
Date	Enter the date of the movement related to the restricted securities position or use the <i>calendar</i> icon. The default value is the current business day. Required format is: YYYY-MM-DD The 'Date' must be a valid business date earlier than or equal to the current business date.
Restriction Reference	Enter the restriction reference. Required format is: max. 16 characters (SWIFT-x)
Nil Securities Position included	Select if you want to include securities positions without securities.
Securities Restriction Details - List	
Securities Account Number	Shows the number of the securities account of the securities restriction. Reference for error message: <input type="checkbox"/> QMPC030
ISIN	Shows the ISIN of the security.
Restriction Type	Shows the restriction type of the securities restriction.

Securities Restriction Details – Search Criteria	
	Reference for error message: <input type="checkbox"/> QMPC091
Date and Time	Shows the date and time of the balance or the closest previous date. Displayed format is: YYYY-MM-DD hh:mm:ss:µsµsµsµsµs
Restriction Reference	Shows the restriction reference of the securities restriction.
Positions	
Settlement Type	Shows the quantity type related to the securities from the possible values: <input type="checkbox"/> Units <input type="checkbox"/> Face
Currency	Shows the issuance currency of the security when the quantity type of the securities is set to 'F' (face amount).
Remaining	Shows the quantity of the remaining securities restrictions.
Used	Shows the quantity of the utilised securities restrictions.
To be Pre-Empted	Shows the quantity of the securities restrictions to be pre-empted.

Buttons

Buttons	
Search	This function enables you to start a search according to the criteria entered. The results are displayed in a list on the same screen. Next screen: <input type="checkbox"/> <i>Securities restriction details – search/list</i> screen References for error messages: <input type="checkbox"/> QMPC030 <input type="checkbox"/> QMPC032 <input type="checkbox"/> QMPC048 <input type="checkbox"/> QMPC091
Reset	This function enables you to set default search criteria and blanks out all optional criteria. Next screen: <input type="checkbox"/> <i>Securities restriction details – search/list</i> screen

2.2.2 Settlement

2.2.2.1 Allegement Instructions - Search/List Screen

Context of Usage	<p>This screen contains a number of search fields. By inputting the relevant data, you can search for allegement instructions. The search results will be displayed in a list, which is sorted by the values of the 'Allegement Identification' column in ascending order (default setting). After selecting an entry, you can proceed further by clicking on the buttons below.</p> <p>When exporting the content of this screen, you receive the list and the corresponding details for each data record.</p> <p>This screen is not relevant for CB users.</p> <p>This function is only available in U2A mode.</p>
Screen Access	<ul style="list-style-type: none">□ Securities >> Settlement >> Settlement Instruction Allegements
Privileges	<p>To use this screen you need the following privilege [▶ 1196]:</p> <ul style="list-style-type: none">□ Allegement query
References	<p>User Instructions Part</p> <p>This screen is part of the following business scenarios:</p> <ul style="list-style-type: none">□ Respond to an allegement instruction [▶ 737]□ View allegement settlement instruction details [▶ 743] <p>Business Functionality Document</p> <p>This screen corresponds to the following business functions:</p> <ul style="list-style-type: none">□ Query allegements (T2S.GUI.SESE.ALG.0010)□ Display allegement list (T2S.GUI.SESE.ALG.0020)

Screenshot

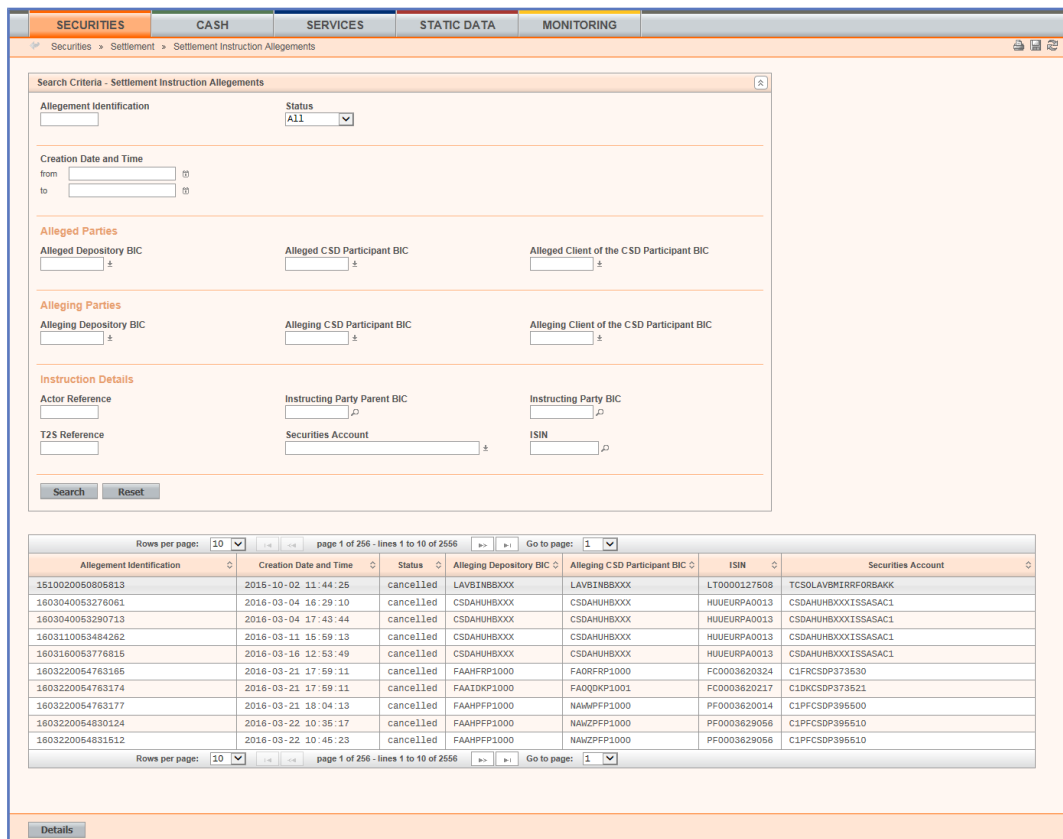

Illustration 42: Allegement instructions - search/list screen

Field Description

Settlement Instruction Allegement – Search Criteria	
Allegement Identification	Enter the unique identification of the allegation. Required format is: max. 16 characters (SWIFT-x)
Status	Select the status of the allegation from the possible values: <input type="checkbox"/> Sent <input type="checkbox"/> Removed <input type="checkbox"/> Cancelled <input type="checkbox"/> All (default value)
Creation Date and Time from	Enter the lower bound of the search range for the date and time from which the allegation was created or use the <i>calendar</i> icon. Required format is: YYYY-MM-DD hh:mm:ss Reference for error message [▶ 1257]: <input type="checkbox"/> QMPC015
Creation Date and Time to	Enter the upper bound of the search range for the date and time until which the allegation was created or use the <i>calendar</i> icon.

Settlement Instruction Allegement – Search Criteria	
	<p>Required format is: YYYY-MM-DD hh:mm:ss</p> <p>Reference for error message [▶ 1257]:</p> <p><input type="checkbox"/> QMPC015</p>
Alleged Parties	
Alleged Depository BIC	<p>You can choose to either enter the BIC of the alleged depository or to select it from the suggested items in the drop-down menu.</p> <p>Required format is: max. 11 characters (SWIFT-x)</p>
Alleged CSD Participant BIC	<p>You can choose to either enter the BIC of the alleged CSD participant or to select it from the suggested items in the drop-down menu.</p> <p>Required format is: max. 11 characters (SWIFT-x)</p>
Alleged Client of the CSD Participant BIC	<p>You can choose to either enter the BIC of the alleged client of the CSD participant or to select it from the suggested items in the drop-down menu.</p> <p>Required format is: max. 11 characters (SWIFT-x)</p>
Alleging Parties	
Alleging Depository BIC	<p>You can choose to either enter the BIC of the alleging depository or to select it from the suggested items in the drop-down menu.</p> <p>Required format is: max. 11 characters (SWIFT-x)</p>
Alleging CSD Participant BIC	<p>You can choose to either enter the BIC of the alleging CSD participant or to select it from the suggested items in the drop-down menu.</p> <p>Required format is: max. 11 characters (SWIFT-x)</p>
Alleging Client of the CSD Participant BIC	<p>You can choose to either enter the BIC of the alleging client of the CSD participant or to select it from the suggested items in the drop-down menu.</p> <p>Required format is: max. 11 characters (SWIFT-x)</p>
Instruction Details	
Actor Reference	<p>Enter the identification of the settlement instruction assigned by the T2S actor.</p> <p>Required format is: max. 16 characters (SWIFT-x)</p>

Settlement Instruction Allegement – Search Criteria	
Instructing Party BIC	You can choose to either enter the BIC of the instructing party or to select it from the suggested items in the drop-down menu. Required format is: max. 11 characters (SWIFT-x)
Instructing Party Parent BIC	You can choose to either enter the parent BIC of the instructing party or to select it from the suggested items in the drop-down menu. Required format is: max. 11 characters (SWIFT-x)
T2S Reference	Enter the identification of the settlement instruction assigned by T2S. Required format is: max. 16 characters (SWIFT-x)
ISIN	Select the ISIN of the security from the drop-down menu.
Securities Account	You can choose to either enter the securities account number or to select it from the suggested items in the drop-down menu. For a RECE SI the securities account number is the securities account of the delivering party. For a DELI SI the securities account number is the securities account of the receiving party. Required format is: max. 35 characters (SWIFT-x)
Settlement Instruction Allegement - List	
Allegation Identification	Shows the unique identification of the allegation.
Creation Date and Time	Shows the date and time when the allegation was created. Displayed format is: YYYY-MM-DD hh:mm:ss:µsµsµsµsµs
Status	Shows the status of the allegation from the possible values: <input type="checkbox"/> Sent <input type="checkbox"/> Removed <input type="checkbox"/> Cancelled
Alleging Depository BIC	Shows the BIC of the party that interacts with the depository.
Alleging CSD Participant BIC	Shows the BIC of the CSD participant.

Settlement Instruction Allegement – Search Criteria	
ISIN	Shows the ISIN of the security.
Securities Account	Shows the securities account number. For a RECE SI the securities account number is the securities account of the delivering party. For a DELI SI the securities account number is the securities account of the receiving party.

Buttons

Buttons	
Search	<p>This function enables you to start a search according to the criteria entered. The results are displayed in a list on the same screen.</p> <p>If the search retrieves a single record, the <i>details</i> screen is displayed directly.</p> <p>Next screens:</p> <ul style="list-style-type: none"> <input type="checkbox"/> <i>Allegement instructions – search/list</i> screen <input type="checkbox"/> <i>Allegement instruction – details</i> screen [▶ 94] <p>Reference for error message [▶ 1257]:</p> <ul style="list-style-type: none"> <input type="checkbox"/> QMPC015
Reset	<p>This function enables you to set default search criteria and blanks out all optional criteria.</p> <p>Next screen:</p> <ul style="list-style-type: none"> <input type="checkbox"/> <i>Allegement instructions – search/list</i> screen
Details	<p>This function enables you to display the details of the selected allegement instruction.</p> <p>Next screen:</p> <ul style="list-style-type: none"> <input type="checkbox"/> <i>Allegement instruction – details</i> screen [▶ 94]

2.2.2.2 Allegement Instruction - Details Screen

Context of Usage

This screen displays detailed information on an allegement instruction. You can check the data and proceed further by clicking on the button below.

You can check the specific details of an allegement instruction and create a new settlement instruction based on the information of the allegement.

This screen is not available for CB users.

This function is only available in U2A mode.

Screen Access Securities >> Settlement >> Settlement Instruction Allegements >> *Allegement instructions – search/list* screen >> Click on the *search and/or details* button

Privileges No privilege needed to use this screen.

References **User Instructions Part**

This screen is part of the following business scenarios:

- Respond to an allegement instruction [▶ 737]
- View allegement settlement instruction details [▶ 743]

Business Functionality Document

This screen corresponds to the following business function:

- Display allegement details (T2S.GUI.SESE.ALG.0030)

Screenshot

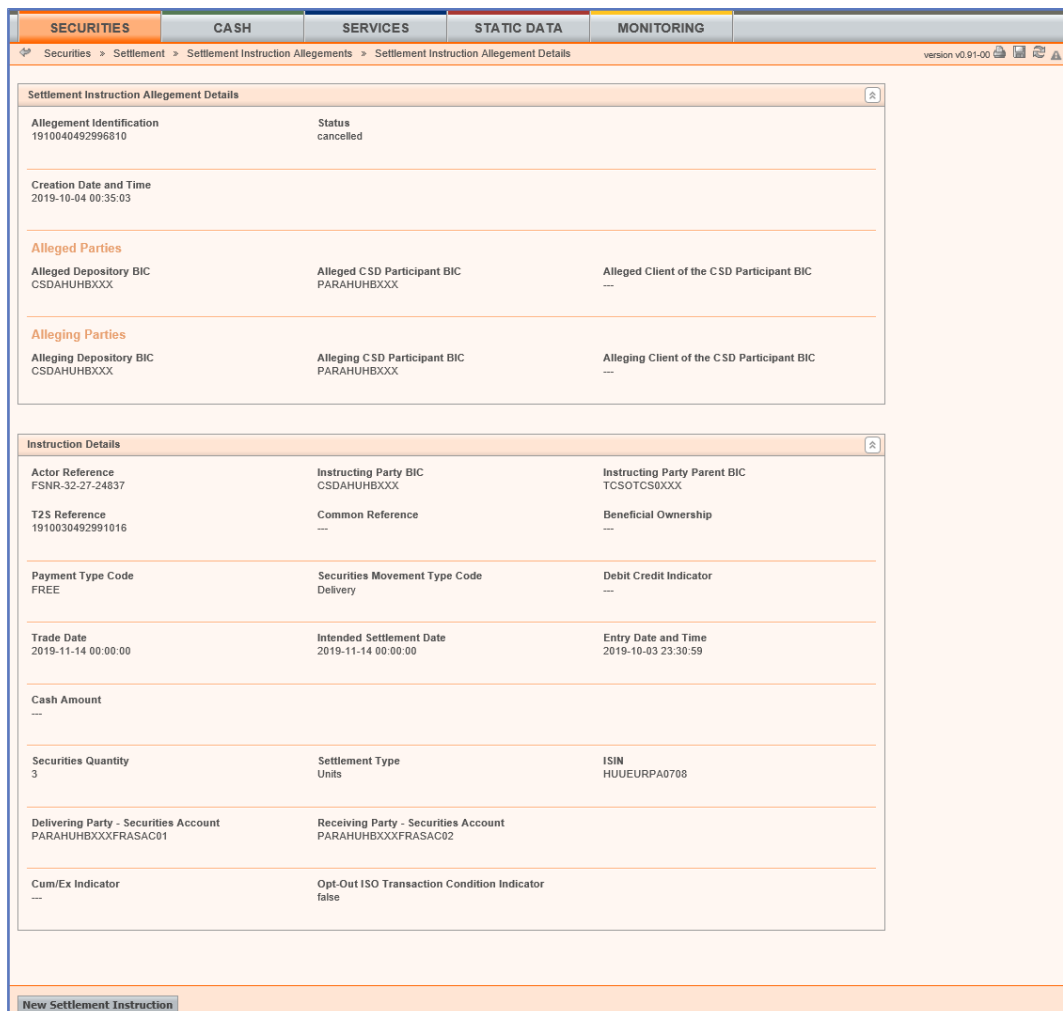

Illustration 43: Allegement instruction – details screen

Field Description

Allegement Details	
Allegement Identification	Shows the unique identification of the allegement.

Allegation Details	
Status	Shows the status of the allegation from the possible values: <input type="checkbox"/> Sent <input type="checkbox"/> Removed <input type="checkbox"/> Cancelled
Creation Date and Time	Shows date and time when the allegation was created. Displayed format is: YYYY-MM-DD hh:mm:ss:µsµsµsµsµs
Alleged Parties	
Alleged Depository BIC	Shows the BIC of the alleged party that interacts with the depository.
Alleged CSD Participant BIC	Shows the BIC of the alleged CSD participant.
Alleged Client of the CSD Participant BIC	Shows the BIC of the alleged client of the CSD participant.
Alleging Parties	
Alleging Depository BIC	Shows the BIC of the alleging party that interacts with the depository.
Alleging CSD Participant BIC	Shows the BIC of the alleging CSD participant.
Alleging Client of the CSD Participant BIC	Shows the BIC of the client of the alleging CSD participant.
Instruction Details	
Actor Reference	Shows the identification of the settlement instruction assigned by the T2S actor.
Instructing Party BIC	Shows the BIC of the instructing party of the settlement instruction.
Instructing Party Parent BIC	Shows the parent BIC of the instructing party of the settlement instruction.
T2S Reference	Shows the identification of the settlement instruction assigned by T2S.
Common Reference	Shows the reference provided by the T2S actor when the LCMM instruction is already matched or in order to facilitate the matching within T2S.
Beneficial Ownership	Shows if there is a change of beneficial ownership: <input type="checkbox"/> Empty (default value)

Allegation Details	
	<input type="checkbox"/> Yes <input type="checkbox"/> No
Payment Type Code	Shows if the transaction is to be settled with or without payment from the possible values: <input type="checkbox"/> APMT (for 'Against Payment Settlement') <input type="checkbox"/> FREE (for 'Separate Settlement')
Securities Movement Type Code	Shows if the movement on a securities account results from a deliver or a receive instruction from the possible values: <input type="checkbox"/> DELI (for 'Delivery') <input type="checkbox"/> RECE (for 'Receive')
Credit Debit Indicator	Shows if the original settlement amount is to be credited or debited from the possible values: <input type="checkbox"/> CRDT (for 'Credit') <input type="checkbox"/> DBIT (for 'Debit')
Trade Date	Shows the date at which the contract was made. Displayed format is: YYYY-MM-DD hh:mm:ss:µsµsµsµsµs
Intended Settlement Date	Shows the date at which the settlement instruction becomes eligible to be submitted to settlement. Displayed format is: YYYY-MM-DD hh:mm:ss:µsµsµsµsµs
Entry Date and Time	Shows the date and time when the settlement instruction has been created. Displayed format is: YYYY-MM-DD hh:mm:ss:µsµsµsµsµs
Cash Amount	Shows the settlement amount and the currency stated in the settlement instruction.
Securities Quantity	Shows the quantity of the securities stated in the settlement instruction.
Settlement Type	Shows the type of settlement foreseen for the security stated in the settlement instruction from the possible values: <input type="checkbox"/> Units <input type="checkbox"/> Face Amount
ISIN	Shows the ISIN of the security.
Delivering Party – Securities Account	Shows the number of the securities account of the delivering party.

Allegation Details	
Receiving Party – Securities Account	Shows the number of the securities account of the receiving party.
CUM/EX Indicator	Shows whether the contract was traded cum or ex coupon from the possible values: <ul style="list-style-type: none"> <input type="checkbox"/> Empty <input type="checkbox"/> CUM <input type="checkbox"/> EX
Opt-Out ISO Transaction Condition Indicator	Shows the opt-out ISO transaction from the possible values: <ul style="list-style-type: none"> <input type="checkbox"/> No <input type="checkbox"/> Yes

Buttons

New Settlement Instruction	This function enables you to create a new settlement instruction with the information provided in the allegation instruction. Next screen: <ul style="list-style-type: none"> <input type="checkbox"/> <i>Settlement instruction – new screen</i> [▶ 211]
----------------------------	---

2.2.2.3 Amendment Securities Instruction - Details Screen

Context of Usage

This screen displays detailed information on the selected amendment securities instruction. You can check the data and proceed further by clicking on the buttons below.

This screen is not relevant for CB users.

Screen Access

Securities >> Settlement >> Maintenance Securities Instructions >> *Maintenance securities instructions – search/list* screen >> Click on the *search* and/or *details* button

Privileges

To use this screen, you need the following privilege [▶ 1197]:

Amendment instruction for intra-position movement or settlement instruction audit trail list query

References**User Instructions Part**

This screen is part of the following business scenarios:

- View amendment instruction for a settlement instruction details [▶ 752]
- View amendment instruction for a settlement restriction on securities details [▶ 805]

Business Functionality Document

This screen corresponds to the following business function:

- Display instruction details (T2S.GUI.SESE.INX.0030)

Screenshot

Illustration 44: Amendment securities instruction - details screen

Field

Description

Amendment Securities Instruction Details	
Referenced Instruction	
Instruction Type	Shows the type of instruction referenced by the amendment instruction from the possible values: <ul style="list-style-type: none"> <input type="checkbox"/> Intra-position movement <input type="checkbox"/> Settlement instruction
Actor Reference	Shows the reference assigned by the T2S actor to the referenced instruction.
T2S Reference	Shows the identification of the reference given the referenced instruction by T2S.
Securities Account Number	Shows the securities account number to or from which a securities entry is made.
Securities Account Owner BIC	Shows the BIC of the owner of the securities account.

Amendment Securities Instruction Details	
General	
Instructing Party BIC	Shows the BIC of the instructing party.
Instructing Party Parent BIC	Shows the parent BIC of the instructing party.
User Identification	Shows user identification of the sending party.
Entry Date and Time	Shows the date and time when the amendment instruction has entered in T2S. Displayed format is: YYYY-MM-DD hh:mm:ss:µsµsµsµsµs
Execution Date and Time	Shows the date and time when the amendment instruction has been executed. Displayed format is: YYYY-MM-DD hh:mm:ss:µsµsµsµsµs
Cancellation Status	Shows the cancellation status of the amendment instruction from the possible values: <input type="checkbox"/> DEND (for 'Denied') <input type="checkbox"/> NDEN (for 'Not denied') If the 'Reason Code' field is informed, the cancellation status is set to 'Denied'.
Reason Code	Shows the reason code that informs the reasoning why the amendment instruction has been denied.
Reason Code Description	Shows the description of the reasoning why the amendment instruction has been denied.
Execution Status	Shows the execution status of the amendment instruction from the possible values: <input type="checkbox"/> EXCD (for 'Executed') <input type="checkbox"/> NEXD (for 'Not executed')
Amendment Type	Shows the amendment instruction type from the possible values: <input type="checkbox"/> Priority <input type="checkbox"/> Partial settlement <input type="checkbox"/> Linkages If the value is set to 'Priority', the 'Priority' frame is displayed. If the value is set to 'Partial Settlement', the 'Partial Settlement Indicator' frame is displayed.

Amendment Securities Instruction Details	
	If the value is set to 'Linkages', the 'Linkages' frame is displayed.
Priority	
Priority	Shows the value of the priority assigned by the amendment instruction from the possible values: <ul style="list-style-type: none"> <input type="checkbox"/> Normal <input type="checkbox"/> High <input type="checkbox"/> Reserved This frame is only available if the amendment type is set to 'Priority'.
Partial Settlement Indicator	
Partial Settlement Indicator	Shows the value of the partial settlement indicator indicated in the amendment instruction from the possible values: <ul style="list-style-type: none"> <input type="checkbox"/> Partial not allowed <input type="checkbox"/> Partial settlement cash threshold allowed <input type="checkbox"/> Partial settlement quantity threshold allowed <input type="checkbox"/> Partial allowed This frame is only available if the amendment type is set to 'Partial Settlement Indicator'.
Link	
Link	Shows the type of the link action indicated in the amendment instruction from the possible values: <ul style="list-style-type: none"> <input type="checkbox"/> Link <input type="checkbox"/> Unlink This frame is only available if the amendment type is set to 'Linkages'.
Link Type	Shows the processing position indicated in the amendment instruction from the possible values: <ul style="list-style-type: none"> <input type="checkbox"/> After <input type="checkbox"/> Before <input type="checkbox"/> With This frame is only available if the amendment type is set to 'Linkages'.

Amendment Securities Instruction Details	
Reference Type	<p>Shows the reference type of the instruction to be linked/unlinked to from the possible values:</p> <ul style="list-style-type: none"><input type="checkbox"/> Account owner settlement instruction reference<input type="checkbox"/> Account owner intra balance movement reference<input type="checkbox"/> Account owner intra position movement reference<input type="checkbox"/> Account servicer reference<input type="checkbox"/> Third party reference<input type="checkbox"/> T2S reference <p>This frame is only available if the amendment type is set to 'Linkages'.</p>
Reference	<p>Shows the identification of the instruction to be linked/unlinked to.</p> <p>This frame is only available if the amendment type is set to 'Linkages'.</p>
Reference Owner	<p>Shows the BIC of the instructing party of the instruction to be linked/unlinked to.</p> <p>This field is only filled in if the 'Reference Type' is set to any value different than 'T2S Reference'.</p> <p>This frame is only available if the amendment type is set to 'Linkages'.</p>

Buttons

Revisions	<p>This function enables you to display the revisions of the selected amendment instruction.</p> <p>Next screen:</p> <ul style="list-style-type: none"><input type="checkbox"/> <i>Revisions/audit trail – list</i> screen [▶ 662]
Related Outbound Messages	<p>This function enables you to display the outbound messages related to the amendment instruction.</p> <p>In case the selected amendment instruction is linked to more than one outbound message, the <i>outbound messages - search/list</i> screen is displayed.</p> <p>In case the query returns only one valid message, the <i>outbound message – details</i> screen is displayed directly.</p> <p>Next screens:</p> <ul style="list-style-type: none"><input type="checkbox"/> <i>Outbound messages – search/list</i> screen [646]

	<ul style="list-style-type: none"> □ <i>Outbound message – details</i> screen [654]
Related Inbound Messages	<p>This function enables you to display the inbound messages related to the amendment instruction.</p> <p>In case the selected amendment instruction is linked to more than one inbound message, the <i>inbound messages - search/list</i> screen is displayed.</p> <p>In case the query returns only one valid message, the <i>inbound message – details</i> screen is displayed directly.</p> <p>Next screens:</p> <ul style="list-style-type: none"> □ <i>Inbound messages – search/list</i> screen [▶ 629] □ <i>Inbound message – details</i> screen [▶ 636]
Status History	<p>This function enables you to display the status history of the selected amendment instruction.</p> <p>Next screen:</p> <ul style="list-style-type: none"> □ <i>Status history – details</i> screen [▶ 267]

2.2.2.4 Amendment Securities Instruction - New Screen

Context of Usage

This screen contains a number of fields regarding the amendment of settlement instructions or settlement restrictions on securities (intra-position movements) before their actual settlement or cancellation. You can enter new data. Afterwards you can proceed further by clicking on the buttons below.

This screen is not relevant for CB users.

You can use this screen either in 2-eyes or in 4-eyes mode.

Screen Access

- Securities >> Settlement >> Settlement Instructions >> *Settlement instructions – search/list* screen >> Click on the *search* button >> *Settlement instructions – search/list* screen >> Click on the *details* button >> *Settlement instruction - details* screen >> Click on the *amendment instruction* button
- Securities >> Settlement >> Intra-Position Movements >> *Intra-position movements – search/list* screen >> Click on the *search* button >> *Intra-position movements – search/list* screen >> Click on the *details* button >> *Intra-position movement - details* screen >> Click on the *amendment instruction* button

Privileges

To use this screen you need the following privileges [▶ 1197]:

- Amend process indicator of a non-modifiable settlement instruction on behalf of the instructing party of the underlying instruction

- Send new instruction using a specific instructing party
- Link to an instruction/pool reference belonging to a specific party
- Amend process indicator of a settlement instruction/settlement restriction on securities either on a securities account or on behalf of the CSD in T2S or on behalf of an external CSD

References

User Instructions Part

This screen is part of the following business scenarios:

- Add a link for a settlement restriction on securities [▶ 798]
- Add a link for a settlement instruction [▶ 744]
- Amend partial settlement indicator for a settlement instruction [▶ 747]
- Amend priority for a settlement restriction on securities [▶ 801]
- Amend priority for a settlement instruction [▶ 748]
- Remove a link for a settlement restriction on securities [▶ 803]
- Remove a link for a settlement instruction [▶ 750]

Business Functionality Document

This screen corresponds to the following business function:

- Amend instruction (T2S.GUI.SESE.INX.0040)

Screenshot

Illustration 45: Amendment securities instruction - new screen

Field

Description

Amendment Instruction	
Referred Instruction	
Instruction Type	Shows the type of the referenced instruction from the possible values:

Amendment Instruction	
	<input type="checkbox"/> Settlement instruction <input type="checkbox"/> Intra position movement
Actor Reference	Shows the identification of the referenced instruction assigned by the T2S actor. References for error messages: [▶ 1267] <input type="checkbox"/> MVCP004 <input type="checkbox"/> MVCM957 <input type="checkbox"/> MVCM958 <input type="checkbox"/> MVCM959 <input type="checkbox"/> MVCM960
T2S Reference	Shows the identification of the referenced instruction assigned by T2S. References for error messages: [▶ 1267] <input type="checkbox"/> MVCP004 <input type="checkbox"/> MVCM957 <input type="checkbox"/> MVCM958 <input type="checkbox"/> MVCM959 <input type="checkbox"/> MVCM960 <input type="checkbox"/> MVRI555 <input type="checkbox"/> MVRI575 <input type="checkbox"/> MVRI591
Securities Account Number	Shows the number of the securities account. References for error messages: [▶ 1267] <input type="checkbox"/> MVCP027 <input type="checkbox"/> MVCP044 <input type="checkbox"/> MVCP032
Securities Account Owner BIC	Shows the BIC of the owner of the securities account of the referenced instruction.
Externally Matched	Shows whether the settlement instruction which was sent to T2S, is already matched or not. This field is only available, if the referenced instruction is a settlement instruction.
General	

Amendment Instruction	
Instructing Party Parent BIC	<p>Select the parent BIC of the instructing party from the drop-down menu or search via the <i>magnifier</i> icon.</p> <p>Required format is: max. 11 characters (SWIFT-x)</p> <p>References for error messages: [▶ 1267]</p> <ul style="list-style-type: none"><input type="checkbox"/> MVDC026<input type="checkbox"/> MVCV107<input type="checkbox"/> MVCV232<input type="checkbox"/> MVSP209<input type="checkbox"/> MVCP122 <p>In case the instructing party is not entered, the instructing party informed to the back end module will be the party you belong to. If the Instructing Party Parent BIC is filled in, the Instructing Party BIC has to be filled in too.</p>
Instructing Party BIC	<p>Select the BIC of the instructing party from the drop-down menu or search via the <i>magnifier</i> icon.</p> <p>Required format is: max. 11 characters (SWIFT-x)</p> <p>References for error messages: [▶ 1267]</p> <ul style="list-style-type: none"><input type="checkbox"/> MVDC026<input type="checkbox"/> MVCV107<input type="checkbox"/> MVCV232<input type="checkbox"/> MVSP209<input type="checkbox"/> MVCP122 <p>In case the instructing party is not entered, the instructing party informed to the back end module will be the party you belong to. If the Instructing Party BIC is filled in, the Instructing Party Parent BIC has to be filled in too.</p>
Amendment Counterparty Instruction	<p>Select this checkbox to amend both legs of the referenced settlement instruction.</p> <p>References for error messages: [▶ 1267]</p> <ul style="list-style-type: none"><input type="checkbox"/> MVCP108<input type="checkbox"/> MVCP109 <p>This field is only available if the referenced instruction is a settlement instruction.</p>

Amendment Instruction	
	If the referenced settlement instruction is not an already matched instruction or the actor reference is empty the field is greyed out.
Amendment Type	
Amendment Type	<p>Select the type of amendment of the instruction from the possible values:</p> <ul style="list-style-type: none"> <input type="checkbox"/> Priority <input type="checkbox"/> Linkage information <input type="checkbox"/> Partial settlement indicator (only available in the screen if the referenced instruction is a settlement instruction) <p>References for error messages: [▶ 1267]</p> <ul style="list-style-type: none"> <input type="checkbox"/> MMIA003 <input type="checkbox"/> MMIA004 <input type="checkbox"/> MVCM952 <p>If the amendment type is 'Priority', the fields related to the partial settlement block and the linkages block will not be available.</p> <p>If the amendment type is 'Linkage Information', the fields related to the partial settlement block and the priority block will not be available.</p> <p>If the amendment type is 'Partial Settlement Indicator', the fields related to the priority block and the linkages block will not be available.</p>
Priority	
Priority	<p>Select the level of the priority from the possible values:</p> <ul style="list-style-type: none"> <input type="checkbox"/> Normal (default value) <input type="checkbox"/> High <input type="checkbox"/> Reserved <p>Reference for error message: [▶ 1267]</p> <ul style="list-style-type: none"> <input type="checkbox"/> MVSP209 <p>This frame is only available if the amendment type is set to 'Priority'.</p>
Linkage Information	
Link/Unlink	Select the type of the amendment on links to be performed from the possible values:

Amendment Instruction	
	<input type="checkbox"/> Link <input type="checkbox"/> Unlink References for error messages: [▶ 1267] <input type="checkbox"/> MVCM957 <input type="checkbox"/> MVCM958 <input type="checkbox"/> MVCM959 <input type="checkbox"/> MVCM960 <input type="checkbox"/> MVLI810 <input type="checkbox"/> MVLI811 <input type="checkbox"/> MVLI825 <input type="checkbox"/> MVLI826 <input type="checkbox"/> MVLI827 <input type="checkbox"/> MVLI828 <input type="checkbox"/> MVLI829 <input type="checkbox"/> MVLI830 <input type="checkbox"/> MVLI837 <input type="checkbox"/> MVLI838 <input type="checkbox"/> MVLI839 <input type="checkbox"/> MVLI853 <input type="checkbox"/> MVLI856 <input type="checkbox"/> MVLI859 <input type="checkbox"/> MVLI862 <input type="checkbox"/> MVLI871 This frame is only available if the amendment type is set to 'Linkage Information'.
Link	
Link Type*	Select the processing position of the link from the possible values: <input type="checkbox"/> After <input type="checkbox"/> Before <input type="checkbox"/> With References for error messages: [▶ 1267]

Amendment Instruction	
	<ul style="list-style-type: none"> <input type="checkbox"/> MVCP040 <input type="checkbox"/> MVCP041 <input type="checkbox"/> MVLI809 <input type="checkbox"/> MVLI810 <input type="checkbox"/> MVLI811 <input type="checkbox"/> MVLI825 <input type="checkbox"/> MVLI826 <input type="checkbox"/> MVLI827 <input type="checkbox"/> MVLI828 <input type="checkbox"/> MVLI829 <input type="checkbox"/> MVLI830 <input type="checkbox"/> MVLI837 <input type="checkbox"/> MVLI838 <input type="checkbox"/> MVLI839 <input type="checkbox"/> MVLI853 <input type="checkbox"/> MVLI856 <input type="checkbox"/> MVLI859 <input type="checkbox"/> MVLI862 <input type="checkbox"/> MVLI874 <p>This frame is only available if the amendment type is set to 'Linkage Information'.</p> <p>This field is also available as a show field for existing records.</p>
Reference Type*	<p>Select the reference type of the instruction to be linked/unlinked to from the possible values:</p> <ul style="list-style-type: none"> <input type="checkbox"/> Account Owner Settlement Instruction Reference <input type="checkbox"/> Account Owner Intra Balance Movement Reference <input type="checkbox"/> Account Owner Intra Position Movement Reference <input type="checkbox"/> Account Servicer Reference <input type="checkbox"/> Third Party reference <input type="checkbox"/> T2S reference <p>Reference for error message: [▶ 1267]</p> <ul style="list-style-type: none"> <input type="checkbox"/> MVCP099

Amendment Instruction	
	<p>This frame is only available if the amendment type is set to 'Linkage Information'.</p> <p>This field is also available as a show field for existing records.</p>
Reference*	<p>Enter the identification of the instruction to be linked/unlinked to. Required format is: max. 16 characters (SWIFT-x-red)</p> <p>References for error messages: [▶ 1267]</p> <ul style="list-style-type: none"> <input type="checkbox"/> MVCP099 <input type="checkbox"/> MVLI871 <input type="checkbox"/> MVLI874 <p>This frame is only available if the amendment type is set to 'Linkage Information'.</p> <p>This field is also available as a show field for existing records.</p>
Reference Owner	<p>Enter the BIC of the instructing party of the instruction to be linked/unlinked to.</p> <p>Required format is: max. 11 characters (SWIFT-x)</p> <p>If the 'Reference Type' is set to any value different than 'T2S reference' this field becomes mandatory.</p> <p>This frame is only available if the amendment type is set to 'Linkage Information'.</p> <p>This field is also available as a show field for existing records.</p>
Options	<p>Information on functions (icons) can be found in Common Buttons and Icons.</p>
Partial Settlement Indicator	
Partial Settlement Indicator	<p>Select the value of the partial settlement indicator corresponding to the T2S settlement instruction reference from the possible values:</p> <ul style="list-style-type: none"> <input type="checkbox"/> Partial not allowed (default value) <input type="checkbox"/> Partial settlement cash threshold allowed <input type="checkbox"/> Partial settlement quantity threshold allowed <input type="checkbox"/> Partial allowed

Amendment Instruction

If the amendment request aims at modifying the partial settlement indicator associated to settlement instructions, this field is mandatory.

This frame is only available if the amendment type is set to 'Partial Settlement Indicator'.

Buttons

Submit

This function enables you to create a new amendment securities instruction. Upon clicking on the *submit* button you will be asked to enter your PIN for digital signature purposes (NRO). With the entry of the PIN, T2S attaches a digital signature to the instruction entered by the T2S actor.

Next screens:

- Settlement instructions – search/list* screen [▶ 177] (for a settlement instruction)
- Intra-position movements – search/list* screen [▶ 137] (for a settlement restriction on securities)

References for error messages: [▶ 1267]

- MMIA001
- MMIA002
- MMIA003
- MMIA004
- MMIA005
- MMIA006
- MMIA009
- MVCM952
- MVCM955
- MVCM956
- MVCM957
- MVCM958
- MVCM959
- MVCM960
- MVCP004
- MVCP027
- MVCP028

- MVCP032
- MVCP039
- MVCP040
- MVCP041
- MVCP044
- MVCP095
- MVCP099
- MVCP108
- MVCP109
- MVCP122
- MVCV107
- MVCV232
- MVDC026
- MVLI809
- MVLI810
- MVLI811
- MVLI825
- MVLI826
- MVLI827
- MVLI828
- MVLI829
- MVLI830
- MVLI837
- MVLI838
- MVLI839
- MVLI853
- MVLI856
- MVLI859
- MVLI862
- MVLI871
- MVLI874
- MVRI555

	<input type="checkbox"/> MVRI575 <input type="checkbox"/> MVRI591 <input type="checkbox"/> MVSP209
Reset	<p>This function enables you to set all fields to default value and blanks out all optional fields.</p> <p>Next screen:</p> <input type="checkbox"/> <i>Amendment securities instruction - new</i> screen
Cancel	<p>This function enables you to cancel the process and return to the previous screen.</p> <p>Next screens:</p> <input type="checkbox"/> <i>Settlement instruction - details</i> screen [▶ 192] (for a settlement instruction) <input type="checkbox"/> <i>Intra-position movement - details</i> screen [▶ 144] (for a settlement restriction on securities)

2.2.2.5 Cancellation Securities Instruction - Details Screen

Context of Usage

This screen displays detailed information on the selected cancellation securities instruction. You can check the data and proceed further by clicking on the buttons below.

This screen is not relevant for CB users.

Screen Access

Securities >> Settlement >> Maintenance Securities Instructions >> *Maintenance securities instructions – search/list* screen >> Click on the *search* button >> *Maintenance securities instructions – search/list* screen >> Click on the *details* button

Privileges

To use this screen, you need the following privilege [▶ 1207]:

Cancellation instruction for intra-position movement or settlement instruction audit trail list query

References

User Instructions Part

This screen is part of the following business scenarios:

View cancellation instruction for a settlement instruction details [▶ 770]
 View cancellation instruction for a settlement restriction on securities details [▶ 816]

Business Functionality Document

This screen corresponds to the following business function:

Display instruction details (T2S.GUI.SESE.INX.0030)

Screenshot

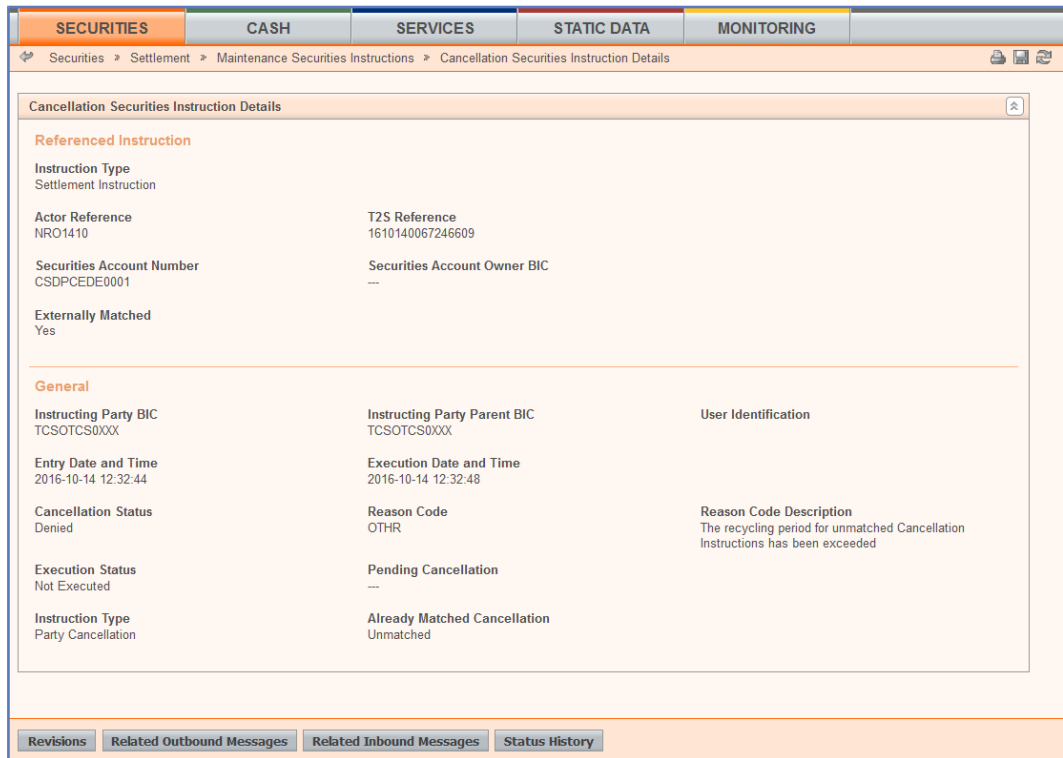

Illustration 46: Cancellation securities instruction - details screen

Field

Description

Cancellation Securities Instruction Details	
Referenced Instruction	
Instruction Type	Shows the type of instruction referenced by the cancellation instruction from the possible values: <input type="checkbox"/> Intra-position movement <input type="checkbox"/> Settlement instruction
Actor Reference	Shows the reference assigned by the T2S actor to the referenced instruction
T2S Reference	Shows the identification of the reference given to the referenced instruction by T2S.
Securities Account Number	Shows the securities account number to or from which a securities entry is made.
Securities Account Owner BIC	Shows the owner of the securities account.
Externally Matched	Shows if the settlement instruction is externally matched or not from the possible values: <input type="checkbox"/> Yes <input type="checkbox"/> No

Cancellation Securities Instruction Details	
	This field is only available, if the instruction type is set to 'Settlement Instruction'.
General	
Instructing Party BIC	Shows the BIC of the instructing party.
Instructing Party Parent BIC	Shows the parent BIC of the instructing party.
User Identification	Shows user identification of the sending party.
Entry Date and Time	Shows the date and time when the cancellation instruction has entered in T2S. Displayed format is: YYYY-MM-DD hh:mm:ss
Execution Date and Time	Shows the date and time when the cancellation instruction has been executed. Displayed format is: YYYY-MM-DD hh:mm:ss
Cancellation Status	Shows the cancellation status of the cancellation instruction from the possible values: <input type="checkbox"/> Denied <input type="checkbox"/> Not denied
Reason Code	Shows the reason code that informs the reasoning why the cancellation instruction has been denied or has not yet been executed.
Reason Code Description	Shows the description of the reasoning why the cancellation instruction has been denied or has not yet been executed.
Execution Status	Shows the execution status of the cancellation instruction from the possible values: <input type="checkbox"/> Executed <input type="checkbox"/> Not executed
Pending Cancellation	Shows if the cancellation instruction is pending to be executed, awaiting for cancellation from the counterparty or CoSD cancellation from another administering party from the possible values: <input type="checkbox"/> Empty (default value) <input type="checkbox"/> Yes

Cancellation Securities Instruction Details	
	This field is only available, if the instruction type is set to 'Settlement Instruction' and if the settlement instruction has been matched
Instruction Type	Shows the cancellation instruction type from the possible values: <ul style="list-style-type: none"> <input type="checkbox"/> Party cancellation <input type="checkbox"/> CSD cancellation <input type="checkbox"/> CoSD cancellation (only possible if the instruction type is a settlement instruction)
Already Matched Cancellation	Shows if the cancellation instruction is externally matched or not from the possible values: <ul style="list-style-type: none"> <input type="checkbox"/> Yes <input type="checkbox"/> No

Buttons

Revisions	This function enables you to display the revisions of the selected cancellation instruction. Next screen: <ul style="list-style-type: none"> <input type="checkbox"/> <i>Revisions/audit trail – list</i> screen [▶ 662]
Related Outbound Messages	This function enables you to display the outbound messages related to the cancellation instruction. In case the selected cancellation instruction is linked to more than one outbound message, the <i>outbound messages - search/list</i> screen is displayed. If the search retrieves a single message, the <i>outbound message – details</i> screen is displayed directly. Next screens: <ul style="list-style-type: none"> <input type="checkbox"/> <i>Outbound messages – search/list</i> screen [▶ 646] <input type="checkbox"/> <i>Outbound message – details</i> screen [▶ 654]
Related Inbound Messages	This function enables you to display the inbound message related to the cancellation instruction. In case the selected cancellation instruction is linked to more than one inbound message, the <i>inbound messages - search/list</i> screen is displayed. If the search retrieves a single message, the <i>inbound message – details</i> screen is displayed directly.

	<p>Next screens:</p> <ul style="list-style-type: none"> <input type="checkbox"/> <i>Inbound messages – search/list</i> screen [▶ 629] <input type="checkbox"/> <i>Inbound message – details</i> screen [▶ 636]
Status History	<p>This function enables you to display the status history of the selected cancellation instruction.</p> <p>Next screen:</p> <ul style="list-style-type: none"> <input type="checkbox"/> <i>Status history – details</i> screen [▶ 267]

2.2.2.6 Cancellation Securities Instruction - New Screen

Context of Usage

This screen contains a number of fields regarding cancellation securities instructions. You can enter new data. Afterwards you can proceed further by clicking on the buttons below.

You can use this screen either in 2-eyes or in 4-eyes mode.

This screen is not relevant for CB users.

Screen Access

- Securities >> Settlement >> Settlement Instructions >> *Settlement instructions – search/list* screen >> Click on the *search* button >> *Settlement instructions – search/list* screen >> Click on the *details* button >> *Settlement instruction - details* screen >> Click on the *cancellation instruction* button
- Securities >> Settlement >> Intra-Position Movements >> *Intra-position movements – search/list* screen >> Click on the *search* button >> *Intra-position movements – search/list* screen >> Click on the *details* button >> *Intra-position movement - details* screen >> Click on the *cancellation instruction* button

Privileges

To use this screen you need the following privileges [▶ 1207]:

- Send new instruction using a specific instructing party
- Cancel settlement instruction/settlement restriction on securities either on a securities account or on behalf of the CSD in T2S, on behalf of external CSD or on behalf of an administering party
- Cancel non-modifiable instructions on behalf of the instructing party of the underlying settlement instruction

References

User Instructions Part

This screen is part of the following business scenarios:

- Cancel a settlement restriction on securities [▶ 814]
- Cancel a settlement instruction [▶ 768]

Business Functionality Document

This screen corresponds to the following business function:

- Cancel instruction (T2S.GUI.SESE.INX.0050)

Screenshot

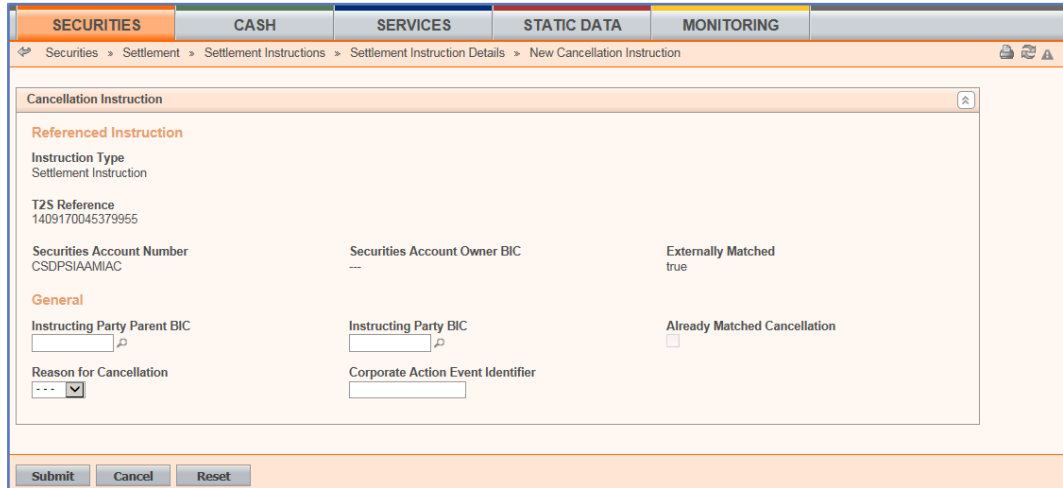

Illustration 47: Cancellation securities instruction - new screen

Field Description

Cancellation Instruction	
Referenced Instruction	
Instruction Type	Shows the type of the referenced instruction from the possible values: <ul style="list-style-type: none"> <input type="checkbox"/> Settlement instruction <input type="checkbox"/> Intra-position movement
Actor Reference	Shows the identification of the referenced instruction assigned by the T2S actor. Reference for error message [▶ 1288]: <ul style="list-style-type: none"> <input type="checkbox"/> MVCP003 <input type="checkbox"/> MVRI592
T2S Reference	Shows the identification of the referenced instruction assigned by T2S. References for error messages [▶ 1288]: <ul style="list-style-type: none"> <input type="checkbox"/> MVCP003 <input type="checkbox"/> MVRI592
Securities Account Number	Shows the securities account of the referenced instruction. References for error messages [▶ 1288]: <ul style="list-style-type: none"> <input type="checkbox"/> MVCP044 <input type="checkbox"/> MVCP029 <input type="checkbox"/> MVCP033

Cancellation Instruction	
Securities Account Owner BIC	Shows the BIC of the owner of the securities account of the referenced instruction.
Externally Matched	<p>Shows if the settlement instruction is externally matched from the possible values:</p> <ul style="list-style-type: none"><input type="checkbox"/> Yes<input type="checkbox"/> No <p>If the referenced instruction is a settlement instruction, this field is only available.</p>
General	
Instructing Party Parent BIC	<p>Select the parent BIC of the instructing party from the drop-down menu or search via the <i>magnifier</i> icon.</p> <p>Required format is: max. 11 characters (SWIFT-x)</p> <p>References for error messages [▶ 1288]:</p> <ul style="list-style-type: none"><input type="checkbox"/> MVRI594<input type="checkbox"/> MVDC027<input type="checkbox"/> MVCV108<input type="checkbox"/> MVCV231<input type="checkbox"/> MMCI106<input type="checkbox"/> MMCI105<input type="checkbox"/> MMCI107<input type="checkbox"/> MMCI108<input type="checkbox"/> MMCI109<input type="checkbox"/> MVRI592<input type="checkbox"/> MVCP123 <p>In case the instructing party is not entered, the instructing party informed to the back end module will be the party you belong to. If the 'Instructing Party Parent BIC' is filled in, the 'Instructing Party BIC' has to be filled in too.</p>
Instructing Party BIC	<p>Select the BIC of the instructing party from the drop-down menu or search via the <i>magnifier</i> icon.</p> <p>Required format is: max. 11 characters (SWIFT-x)</p> <p>References for error messages [▶ 1288]:</p> <ul style="list-style-type: none"><input type="checkbox"/> MVRI594<input type="checkbox"/> MVDC027

Cancellation Instruction	
	<ul style="list-style-type: none"> <input type="checkbox"/> MVCV108 <input type="checkbox"/> MVCV231 <input type="checkbox"/> MMCI106 <input type="checkbox"/> MVCP104 <input type="checkbox"/> MVCP105 <input type="checkbox"/> MVCP123 <input type="checkbox"/> MMCI105 <input type="checkbox"/> MMCI107 <input type="checkbox"/> MMCI108 <input type="checkbox"/> MMCI109 <input type="checkbox"/> MVRI592 <p>In case the instructing party is not entered, the instructing party informed to the back end module will be the party you belong to. If the 'Instructing Party BIC' is filled in, the 'Instructing Party Parent BIC' has to be filled in too.</p>
Already Matched Cancellation	<p>Select the already matched cancellation value to cancel both legs of the settlement instruction.</p> <p>This field is only available if the referenced instruction is a settlement instruction.</p> <p>If the referenced settlement instruction is not an already matched instruction or the actor reference is empty the field is greyed out.</p> <p>References for error messages [▶ 1288]:</p> <ul style="list-style-type: none"> <input type="checkbox"/> MVCP104 <input type="checkbox"/> MVCP105
Reason for cancellation	<p>Select the applicable reason for the cancellation of the settlement instruction from the possible values:</p> <ul style="list-style-type: none"> <input type="checkbox"/> Empty (default value) <input type="checkbox"/> BYIY <input type="checkbox"/> CANT (Cancelled due to transformation) <input type="checkbox"/> CANI <input type="checkbox"/> CTHP <input type="checkbox"/> CSUB <input type="checkbox"/> CXLR

Cancellation Instruction	
	<ul style="list-style-type: none"> <input type="checkbox"/> CANZ <input type="checkbox"/> CORP <input type="checkbox"/> SCEX <input type="checkbox"/> OTHR <p>This field is only available if the referenced instruction is a settlement instruction or intra-position movement</p>
Corporate Action Event Identifier	<p>Enter the identification of the corporate action event.</p> <p>Required format is: max. 16 characters (SWIFT-x-red)</p>

Buttons

Submit	<p>This function enables you to create a new cancellation securities instruction. Upon clicking on the <i>submit</i> button you will be asked to enter your PIN for digital signature purposes (NRO). With the entry of the PIN, T2S attaches a digital signature to the instruction entered by the T2S actor.</p> <p>Next screens:</p> <ul style="list-style-type: none"> <input type="checkbox"/> <i>Intra-position movements– search/list</i> screen [▶ 137] (for a settlement instruction) <input type="checkbox"/> <i>Settlement instructions– search/list</i> screen [▶ 177] (for a settlement restriction on securities) <p>References for error messages [▶ 1288]:</p> <ul style="list-style-type: none"> <input type="checkbox"/> MMCR201 <input type="checkbox"/> MMCR202 <input type="checkbox"/> MMCI101 <input type="checkbox"/> MMCI102 <input type="checkbox"/> MMCI105 <input type="checkbox"/> MMCI106 <input type="checkbox"/> MMCI107 <input type="checkbox"/> MMCI108 <input type="checkbox"/> MMCI109 <input type="checkbox"/> MVCP003 <input type="checkbox"/> MVCP029 <input type="checkbox"/> MVCP030 <input type="checkbox"/> MVCP031

	<ul style="list-style-type: none"><input type="checkbox"/> MVCP033<input type="checkbox"/> MVCP044<input type="checkbox"/> MVCP048<input type="checkbox"/> MVCP096<input type="checkbox"/> MVCP104<input type="checkbox"/> MVCP105<input type="checkbox"/> MVCP123<input type="checkbox"/> MCVV108<input type="checkbox"/> MCVV231<input type="checkbox"/> MVDC027<input type="checkbox"/> MVRI576<input type="checkbox"/> MVRI592<input type="checkbox"/> MVRI594
Reset	<p>This function enables you to set all fields to default value and blanks out all optional fields.</p> <p>Next screen:</p> <ul style="list-style-type: none"><input type="checkbox"/> <i>Cancellation securities instruction - new screen</i>
Cancel	<p>This function enables you to cancel the process and return to the previous screen.</p> <p>Next screens:</p> <ul style="list-style-type: none"><input type="checkbox"/> <i>Settlement instruction - details screen</i> [▶ 192] (for a settlement instruction)<input type="checkbox"/> <i>Intra-position movement - details screen</i> [▶ 144] (for a settlement restriction on securities)

2.2.2.7 Data Changes - Search/List Screen

See *Data Changes – Search/List Screen* [▶ 608].

2.2.2.8 Data Change - Details Screen

See *Data Changes – Details Screen* [▶ 612].

2.2.2.9 Hold/Release Instruction - Details Screen

Context of Usage

This screen displays detailed information on the selected hold/release instruction. You can check the data and proceed further by clicking on the buttons below.

This screen is not relevant for CB users.

Screen Access Securities >> Settlement >> Maintenance Securities Instructions >> *Maintenance securities instructions – search/list* screen >> Click on the *search* and/or *details* button

Privileges To use this screen, you need the following privilege [[▶ 1211](#)]:

Hold/release audit trail list query

References **User Instructions Part**

This screen is part of the following business scenario:

View hold/release instruction details [[▶ 766](#)]

Business Functionality Document

This screen corresponds to the following business function:

Display instruction details (T2S.GUI.SESE.INX.0030)

Screenshot

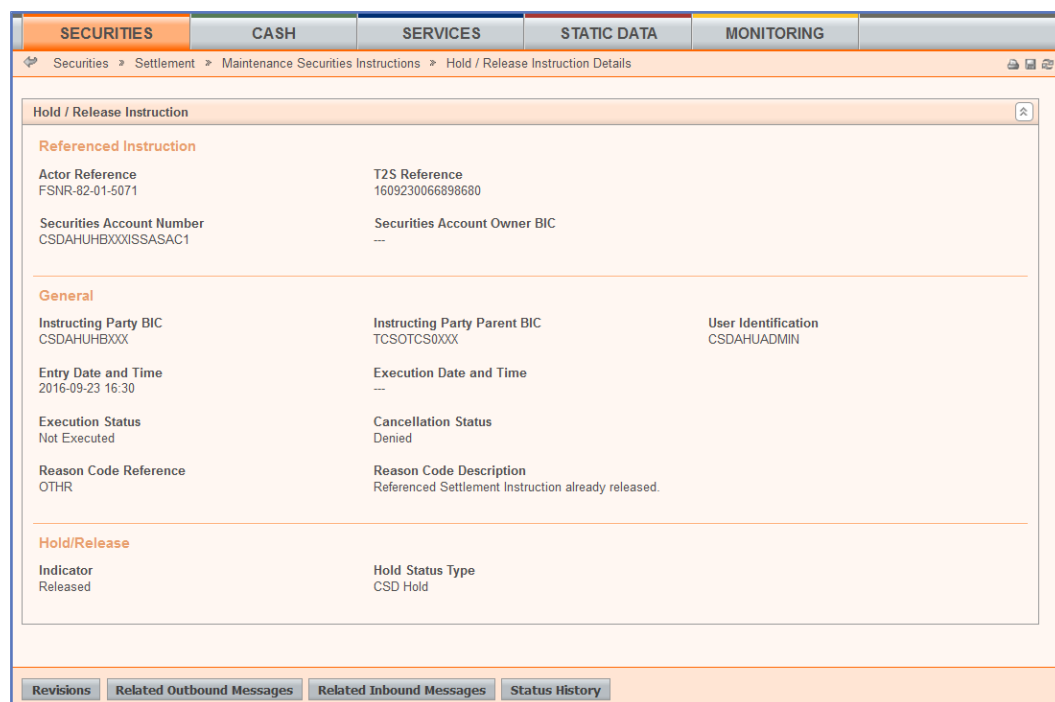

Illustration 48: Hold/release instruction – details screen

Field Description

Hold/Release Instruction	
Referenced Instruction	
Actor Reference	Shows the reference assigned by the T2S actor to the referenced instruction.
T2S Reference	Shows the identification of the reference assigned to the referenced instruction by T2S.
Securities Account Number	Shows the securities account number to or from which a securities entry is made.

Hold/Release Instruction	
Securities Account Owner BIC	Shows the owner of the securities account.
General	
Instructing Party BIC	Shows the BIC of the instructing party.
Instructing Party Parent BIC	Shows the parent BIC of the instructing party.
User Identification	Shows user identification of the sending party.
Entry Date and Time	Shows the date and time when the hold/release instruction has entered in T2S. Displayed format is: YYYY-MM-DD hh:mm:ss:µsµsµsµsµs
Execution Date and Time	Shows the date and time when the hold/release instruction has been executed. Displayed format is: YYYY-MM-DD hh:mm:ss:µsµsµsµsµs
Execution Status	Shows the execution status of the hold/release instruction from the possible values: <input type="checkbox"/> Executed <input type="checkbox"/> Not executed
Cancellation Status	Shows the cancellation status of the hold/release instruction from the possible values: <input type="checkbox"/> Denied <input type="checkbox"/> Not denied If the 'Reason Code Reference' field is filled in, the cancellation status is always set to 'Denied'.
Reason Code Reference	Shows the reason code that informs the reasoning why the hold/release instruction has been denied.
Reason Code Description	Shows the description that informs the reason why the hold/release instruction has been denied.
Hold/Release	
Indicator	Shows the hold/release instruction type from the possible values: <input type="checkbox"/> Hold <input type="checkbox"/> Release
Hold Status Type	Shows the type of hold indicator from the possible values: <input type="checkbox"/> Party hold

Hold/Release Instruction	
	<ul style="list-style-type: none"><input type="checkbox"/> CSD hold<input type="checkbox"/> CSD validation hold<input type="checkbox"/> CoSD hold
Buttons	
Revisions	<p>This function enables you to display the revisions of the selected hold/release instruction.</p> <p>Next screen:</p> <ul style="list-style-type: none"><input type="checkbox"/> <i>Revisions/audit trail – list</i> screen [▶ 662]
Related Outbound Messages	<p>This function enables you to display the outbound messages related to the hold/release instruction.</p> <p>In case the hold/release instruction is linked to more than one outbound message, the <i>outbound messages - search/list</i> screen is displayed.</p> <p>In case the query returns only one valid message, the <i>outbound message – details</i> screen is displayed directly.</p> <p>Next screen:</p> <ul style="list-style-type: none"><input type="checkbox"/> <i>Outbound messages – search/list</i> screen [▶ 646]<input type="checkbox"/> <i>Outbound message – details</i> screen [▶ 654]
Related Inbound Messages	<p>This function enables you to display the inbound messages related to the hold/release instruction.</p> <p>In case the hold/release instruction is linked to more than one inbound message, the <i>inbound messages - search/list</i> screen is displayed.</p> <p>In case the query returns only one valid message, the <i>inbound message – details</i> screen is displayed directly.</p> <p>Next screen:</p> <ul style="list-style-type: none"><input type="checkbox"/> <i>Inbound messages – search/list</i> screen [▶ 629]<input type="checkbox"/> <i>Inbound message – details</i> screen [▶ 636]
Status History	<p>This function enables you to display the status history of the hold/release instruction.</p> <p>Next screen:</p> <ul style="list-style-type: none"><input type="checkbox"/> <i>Status history – details</i> screen [▶ 267]

2.2.2.10 Hold/Release Instruction - New Screen

Context of Usage	<p>This screen contains a number of fields regarding hold/release instructions. You can enter new data. Afterwards you can proceed further by clicking on the buttons below.</p> <p>You can use this screen either in 2-eyes or in 4-eyes mode.</p> <p>This screen is not relevant for CB users.</p>
Screen Access	<ul style="list-style-type: none"><input type="checkbox"/> <i>Securities >> Settlement >> Settlement Instructions >> Settlement instructions – search/list</i> screen >> Click on the <i>search</i> and/or <i>details</i> button >> <i>Settlement instruction - details</i> screen >> Click on the <i>hold/release</i> button
Privileges	<p>To use this screen, you need the following privileges [▶ 1211]:</p> <ul style="list-style-type: none"><input type="checkbox"/> Party hold settlement instruction on a securities account or on behalf of an external CSD<input type="checkbox"/> CSD hold settlement instruction either on a securities account or on behalf of the CSD in T2S<input type="checkbox"/> Release party hold settlement instruction on a securities account or on behalf of an external CSD<input type="checkbox"/> Release party hold auto-collateralisation instruction on a securities account<input type="checkbox"/> Release CSD hold settlement instruction either on a securities account or on behalf of the CSD in T2S<input type="checkbox"/> Release CSD validation hold settlement instruction either on a securities account or on behalf of the CSD in T2S<input type="checkbox"/> Release CoSD hold settlement instruction on behalf of administering party<input type="checkbox"/> Hold non-modifiable instructions on behalf of the instructing party of the underlying settlement instruction<input type="checkbox"/> Release non-modifiable instructions on behalf of the instructing party of the underlying settlement instruction
References	<p>User Instructions Part</p> <p>This screen is part of the following business scenarios:</p> <ul style="list-style-type: none"><input type="checkbox"/> Put a settlement instruction on CSD hold [▶ 756]<input type="checkbox"/> Put a settlement instruction on party hold [▶ 754]<input type="checkbox"/> Release a settlement instruction from CoSD hold [▶ 763]<input type="checkbox"/> Release a settlement instruction from CSD hold [▶ 761]<input type="checkbox"/> Release a settlement instruction from CSD validation hold [▶ 765]<input type="checkbox"/> Release a settlement instruction from party hold [▶ 758]<input type="checkbox"/> Partially release a settlement instruction from party hold [▶ 759]

Business Functionality Document

This screen corresponds to the following business function:

- Hold/release instruction (T2S.GUI.SESE.INX.0060)

Screenshot

Illustration 49: Hold/release instruction - new screen

Field Description

Hold / Release Instruction	
Referenced Instruction	
Actor Reference	Shows the identification of the referenced settlement instruction assigned by the T2S actor. References for error messages [▶ 1297]: <input type="checkbox"/> MVCP004 <input type="checkbox"/> MVRI591 <input type="checkbox"/> MVRI593
T2S Reference	Shows the identification of the referenced settlement instruction assigned by T2S. References for error messages [▶ 1297]: <input type="checkbox"/> MVCP004 <input type="checkbox"/> MVRI591 <input type="checkbox"/> MVRI593 <input type="checkbox"/> MVRI555 <input type="checkbox"/> MVRI575

Hold / Release Instruction	
	<input type="checkbox"/> MVRI584
Securities Account Number	<p>Shows the securities account of the referenced settlement instruction.</p> <p>References for error messages [▶ 1297]:</p> <input type="checkbox"/> MVCP019 <input type="checkbox"/> MVCP020 <input type="checkbox"/> MVCP044 <input type="checkbox"/> MVCP106 <input type="checkbox"/> MVCP107 <input type="checkbox"/> MVCP111 <input type="checkbox"/> MVCP112 <input type="checkbox"/> MVCP113
Securities Account Owner BIC	Shows the BIC of the owner of the securities account of the referenced settlement instruction.
Externally Matched	Shows whether the settlement instruction was sent to T2S already matched or not.
General	
Instructing Party Parent BIC	<p>Select the parent BIC of the instructing party from the drop-down menu or search via the <i>magnifier</i> icon.</p> <p>Required format is: max. 11 characters (SWIFT-x)</p> <p>References for error messages [▶ 1297]:</p> <input type="checkbox"/> MVCP121 <input type="checkbox"/> MCVV109 <input type="checkbox"/> MCVV233 <input type="checkbox"/> MVDC026 <input type="checkbox"/> MVRI584 <input type="checkbox"/> MVRI595
Instructing Party BIC	<p>Select the BIC of the instructing party of the hold/release instruction from the drop-down menu or search via the <i>magnifier</i> icon.</p> <p>In case the instructing party is not entered, the instructing party informed to the back end module will be the party you belong to. If the 'Instructing Party Parent BIC' is filled in, the 'Instructing Party BIC' has to be filled in too.</p>

Hold / Release Instruction	
	<p>Required format is: max. 11 characters (SWIFT-x)</p> <p>References for error messages [▶ 1297]:</p> <ul style="list-style-type: none"> <input type="checkbox"/> MVCP121 <input type="checkbox"/> MVCV109 <input type="checkbox"/> MVCV233 <input type="checkbox"/> MVDC026 <input type="checkbox"/> MVRI584 <input type="checkbox"/> MVRI595 <p>In case the instructing party is not entered, the instructing party informed to the back end module will be the party you belong to. If the 'Instructing Party BIC' is filled in, the 'Instructing Party Parent BIC' has to be filled in too.</p>
Hold/Release Counterparty Instruction	<p>Select if you want to hold/release both legs of the settlement instruction.</p> <p>References for error messages [▶ 1297]:</p> <ul style="list-style-type: none"> <input type="checkbox"/> MVCP106 <input type="checkbox"/> MVCP107 <input type="checkbox"/> MVCP111 <input type="checkbox"/> MVCP112 <input type="checkbox"/> MVCP113 <input type="checkbox"/> MVCP114 <input type="checkbox"/> MVCP115 <input type="checkbox"/> MVCP116 <input type="checkbox"/> MVCP117 <input type="checkbox"/> MVCP118 <p>If the referenced settlement instruction is not an already matched instruction or the actor reference is empty the field is greyed out.</p>
Hold / Release	
Current Hold Status	
Party Hold Status	Shows the current status of the party hold of the referenced settlement instruction as set by the T2S party.
CSD Hold Status	Shows the current CSD hold status of the referenced settlement instruction as set by the CSD.

Hold / Release Instruction	
CSD Validation Hold Status	<p>Shows the current CSD validation hold status of the referenced settlement instruction.</p> <p>When the settlement instruction fulfills one market-specific restriction which is configured in the T2S reference data table, this attribute has the value:</p> <ul style="list-style-type: none"><input type="checkbox"/> Yes<input type="checkbox"/> No <p>References for error messages [▶ 1297]:</p> <ul style="list-style-type: none"><input type="checkbox"/> MMPR207<input type="checkbox"/> MVRI575
CoSD Hold Status	<p>Shows the current CoSD hold status of the referenced settlement instruction.</p> <p>When the settlement instruction fulfills a CoSD rule set by an administering party, this attribute has the value:</p> <ul style="list-style-type: none"><input type="checkbox"/> Yes<input type="checkbox"/> No <p>References for error messages [▶ 1297]:</p> <ul style="list-style-type: none"><input type="checkbox"/> MVRI575<input type="checkbox"/> MVRI593
Hold Types	
Party Hold	<p>Select the party hold that allows you to send a hold/release instruction to T2S in order to put the referenced instruction on party hold.</p> <p>This field is greyed out in case the referenced instruction is already on 'Party Hold' or you have not the privileges to perform such an operation.</p> <p>References for error messages [▶ 1297]:</p> <ul style="list-style-type: none"><input type="checkbox"/> MMHI104<input type="checkbox"/> MMHI105<input type="checkbox"/> MVCP019<input type="checkbox"/> MVCP046<input type="checkbox"/> MVCP093<input type="checkbox"/> MVCP106<input type="checkbox"/> MVCP114

Hold / Release Instruction	
	<input type="checkbox"/> MVCP116 <input type="checkbox"/> MMPR207
CSD Hold	<p>Select the CSD hold allows you to send a hold/release instruction to T2S in order to put the referenced instruction on CSD hold.</p> <p>This field is greyed out in case the referenced instruction is already on 'CSD Hold' or you have not the privileges to perform such an operation.</p> <p>References for error messages [▶ 1297]:</p> <input type="checkbox"/> MMHI104 <input type="checkbox"/> MMHI105 <input type="checkbox"/> MVCP020 <input type="checkbox"/> MVCP021 <input type="checkbox"/> MVCP046 <input type="checkbox"/> MVCP107 <input type="checkbox"/> MVCP115 <input type="checkbox"/> MVCP117 <input type="checkbox"/> MMPR207
Release Types	
Party Release	<p>Select the party release allows you to send a hold/release instruction to T2S in order to release the referenced instruction which has been previously put on party hold.</p> <p>This field is greyed out in case the referenced instruction is not on 'Party Hold' or you have not the privileges to perform such an operation.</p> <p>References for error messages [▶ 1297]:</p> <input type="checkbox"/> MMRI201 <input type="checkbox"/> MMRI202 <input type="checkbox"/> MMRI204 <input type="checkbox"/> MVCP022 <input type="checkbox"/> MVCP047 <input type="checkbox"/> MVCP094 <input type="checkbox"/> MVCP111 <input type="checkbox"/> MVCP129

Hold / Release Instruction	
	<input type="checkbox"/> MVRI591
CSD Release	<p>Select the CSD release allows you to send a hold/release instruction to T2S in order to release the referenced instruction which has been previously put on CSD hold.</p> <p>This field is greyed out in case the referenced instruction is not on 'CSD Hold' or you have not the privileges to perform such an operation.</p> <p>References for error messages [▶ 1297]:</p> <ul style="list-style-type: none"> <input type="checkbox"/> MMRI201 <input type="checkbox"/> MMRI202 <input type="checkbox"/> MMRI204 <input type="checkbox"/> MVCP023 <input type="checkbox"/> MVCP025 <input type="checkbox"/> MVCP047 <input type="checkbox"/> MVCP112 <input type="checkbox"/> MVRI591
CSD Validation Release	<p>Select the CSD validation release allows you to send a hold/release instruction to T2S in order to release the referenced instruction which has been previously put on CSD validation hold by the system.</p> <p>You cannot put an instruction on 'CSD Validation Hold'. This operation can only be performed by the system.</p> <p>This field is greyed out in case the referenced instruction is not on 'CSD Validation Hold' or you have not the privileges to perform such an operation.</p> <p>References for error messages [▶ 1297]:</p> <ul style="list-style-type: none"> <input type="checkbox"/> MMRI201 <input type="checkbox"/> MMRI202 <input type="checkbox"/> MMRI204 <input type="checkbox"/> MVCP024 <input type="checkbox"/> MVCP026 <input type="checkbox"/> MVCP047 <input type="checkbox"/> MVCP113 <input type="checkbox"/> MVCP118

Hold / Release Instruction	
	<input type="checkbox"/> MVRI591
CoSD Release	<p>Select the CoSD release allows you to send a hold/release instruction to T2S in order to release the referenced instruction which has been previously put on 'CoSD Hold' by the system.</p> <p>References for error messages [▶ 1297]:</p> <ul style="list-style-type: none"> <input type="checkbox"/> MMPR201 <input type="checkbox"/> MMPR202 <input type="checkbox"/> MMPR203 <input type="checkbox"/> MMPR204 <input type="checkbox"/> MMPR207 <input type="checkbox"/> MMPR208 <input type="checkbox"/> MMPR209 <input type="checkbox"/> MMRI201 <input type="checkbox"/> MMRI202 <input type="checkbox"/> MMRI204 <input type="checkbox"/> MVCP047 <input type="checkbox"/> MVRI584 <input type="checkbox"/> MVRI591 <input type="checkbox"/> MVRI593 <input type="checkbox"/> MVRI595
CoSD Rule Identification	<p>Enter the reference of the CoSD rule to be released by the hold/release instruction.</p> <p>Required format is: max. 35 characters (SWIFT-x)</p> <p>In case the referenced instruction is not on 'CoSD Hold', this field must be greyed out.</p> <p>References for error messages [▶ 1297]:</p> <ul style="list-style-type: none"> <input type="checkbox"/> MMPR203 <input type="checkbox"/> MMPR204 <input type="checkbox"/> MMPR208 <input type="checkbox"/> MMPR209 <input type="checkbox"/> MVCP043 <input type="checkbox"/> MVRI571

Hold / Release Instruction	
	<input type="checkbox"/> MVRI572 <input type="checkbox"/> MVRI584 <input type="checkbox"/> MVRI595
Quantity	
Released Quantity	<p>Enter the quantity to be released if you want to partially release a delivering settlement instruction which has been previously put on party hold.</p> <p>This field is only available in case the released instruction is on 'Party Hold' and it is the delivering side of the transaction. If any other hold applies to the instruction, the released instruction is the receiving part of the transaction, it is unmatched, it is an internally generated instruction or its intended settlement date has not been reached, the field is greyed out.</p> <p>Required format is:</p> <p>For settlement type = Unit, max.15 digit(s) incl. decimal point (thereof max. 14 decimal places)</p> <p>For settlement type = Face amount, max. 15 digit(s) incl. decimal point (thereof max. 5 decimal places)</p> <p>References for error messages: [▶ 1297]</p> <input type="checkbox"/> MVRI598 <input type="checkbox"/> MVRI599 <input type="checkbox"/> MVRI600 <input type="checkbox"/> MVRI601 <input type="checkbox"/> MVRI602 <input type="checkbox"/> MVRI603 <input type="checkbox"/> MVRI604 <input type="checkbox"/> SPSA001 <input type="checkbox"/> SPSA002 <input type="checkbox"/> SPSA019
	<p>In case the released quantity is not populated and the party release is selected, the party release instruction will be for the total quantity of the settlement instruction, or for the remaining to be settled quantity in case the settlement instruction has been already partially settled.</p>

Buttons**Submit**

This function enables you to create a new hold/release instruction. Upon clicking on the *submit* button you will be asked to enter your PIN for digital signature purposes (NRO). With the entry of the PIN, T2S attaches a digital signature to the instruction entered by the T2S actor.

Next screen:

Hold/Release Instruction – New screen

References for error messages [▶ 1297]:

- MMHI101
- MMHI102
- MMHI104
- MMHI105
- MMPR201
- MMPR202
- MMPR203
- MMPR204
- MMPR207
- MMPR208
- MMPR209
- MMRI201
- MMRI202
- MMRI204
- MVCP004
- MVCP019
- MVCP020
- MVCP021
- MVCP022
- MVCP023
- MVCP024
- MVCP025
- MVCP026
- MVCP043
- MVCP044

- MVCP046
- MVCP047
- MVCP093
- MVCP094
- MVCP106
- MVCP107
- MVCP111
- MVCP112
- MVCP113
- MVCP114
- MVCP115
- MVCP116
- MVCP117
- MVCP118
- MVCP121
- MVCP129
- MCVV109
- MCVV233
- MVDC026
- MVRI555
- MVRI556
- MVRI571
- MVRI572
- MVRI575
- MVRI584
- MVRI591
- MVRI593
- MVRI595
- MVRI598
- MVRI599
- MVRI600
- MVRI601

	<input type="checkbox"/> MVRI602 <input type="checkbox"/> MVRI603 <input type="checkbox"/> MVRI604 <input type="checkbox"/> SPSA001 <input type="checkbox"/> SPSA002 <input type="checkbox"/> SPSA019
Cancel	<p>This function enables you to cancel the process and return to the previous screen.</p> <p>Next screen:</p> <input type="checkbox"/> <i>Settlement instruction – details</i> screen [▶ 192]
Reset	<p>This function enables you to set all fields to default value and blanks out all optional fields.</p> <p>Next screen:</p> <input type="checkbox"/> <i>Hold/release instruction – new</i> screen

2.2.2.11 Intra-Position Movements - Search/List Screen

Context of Usage

This screen contains a number of search fields. By inputting the relevant data, you can search for settlement restrictions on securities. The search results will be displayed in a list. After selecting an entry, you can proceed further by clicking on the buttons below.

This screen is not relevant for CB users.

Screen Access

Securities >> Settlement >> Intra-Position Movements

Privileges

To use this screen, you need the following privilege [▶ 1218]:

Intra-position movements query

References

User Instructions Part

This screen is part of the following business scenarios:

- Add a link for a settlement restriction on securities [▶ 798]
- Amend the priority for a settlement restriction on securities [▶ 801]
- Cancel a settlement restriction on securities [▶ 814]
- Copy a settlement restriction on securities [▶ 788]
- Enter a Settlement Restriction on Securities [▶ 786]
- Remove a link for a settlement restriction on securities [▶ 803]
- View settlement restriction on securities details [▶ 791]

Business Functionality Document

This screen corresponds to the following business functions:

- Query instruction (T2S.GUI.SESE.INX.0010)
- Display instruction list (T2S.GUI.SESE.INX.0020)

Screenshot

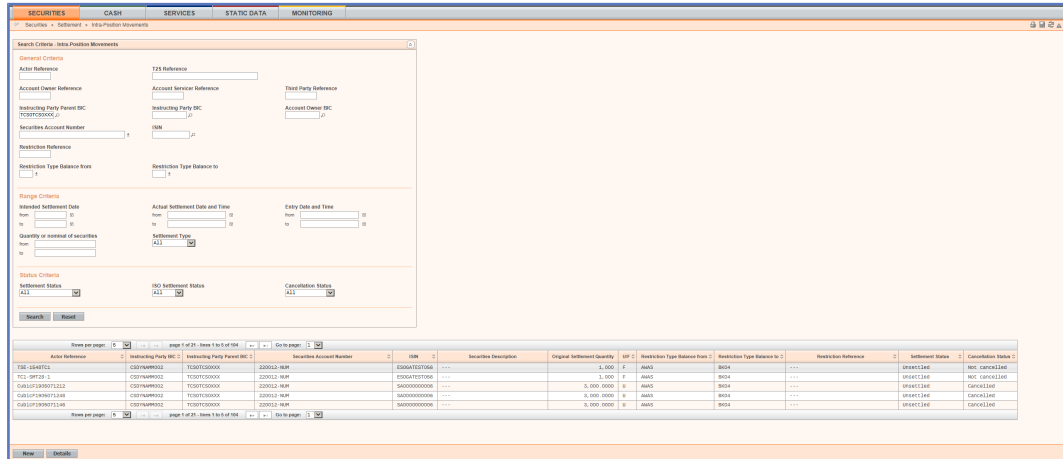

Illustration 50: Intra-position movements - search/list screen

Field Description

Intra-Position Movements – Search Criteria	
Actor Reference	Enter the identification of the reference assigned for a settlement restriction by the T2S actor. Required format is: max. 16 characters (SWIFT-x)
T2S Reference	Enter the identification of the reference assigned for a settlement restriction on securities by T2S. Required format is: max. 16 characters (SWIFT-x)
Securities Account Owner Reference	Enter the reference assigned by the T2S party to the settlement restriction. Required format is: max. 16 characters (SWIFT-x)
Securities Account Servicer Reference	Enter the reference assigned by the CSD to the settlement restriction on cash. Required format is: max. 16 characters (SWIFT-x)
Third Party Reference	Enter the reference assigned by a third party to the instruction. Required format is: max. 16 characters (SWIFT-x)
Instructing Party Parent BIC	Enter the parent BIC of the instructing party or search via the <i>magnifier</i> icon. Required format is: max. 11 characters (SWIFT-x) References for error messages [▶ 1367]: <input type="checkbox"/> QMPC048

Intra-Position Movements – Search Criteria	
	<input type="checkbox"/> QMPC084
Instructing Party BIC	<p>Enter the BIC of the instructing party or search via the <i>magnifier</i> icon.</p> <p>Required format is: max. 11 characters (SWIFT-x)</p> <p>References for error messages [▶ 1367]:</p> <input type="checkbox"/> QMPC032 <input type="checkbox"/> QMPC084
Securities Account Owner BIC	<p>Enter the BIC of the account owner.</p> <p>Required format is: max. 11 characters (SWIFT-x)</p> <p>Reference for error message [▶ 1367]:</p> <input type="checkbox"/> QMPC032
Securities Account Number	<p>Enter the number of the securities account</p> <p>Required format is: max. 35 characters (SWIFT-x)</p> <p>Reference for error message [▶ 1367]:</p> <input type="checkbox"/> QMPC030
ISIN	<p>Enter the ISIN of the securities.</p> <p>Required format is: max. 12 characters (SWIFT-x)</p> <p>Reference for error message [▶ 1367]:</p> <input type="checkbox"/> QMPC018
Restriction Reference	<p>Enter the unique identification of a restricted securities position.</p> <p>Required format is: max. 16 characters (SWIFT-x)</p>
Restriction Type Balance from	<p>Select the restriction type code of the securities position from which the securities have to be restricted/ unrestricted from the drop-down menu.</p> <p>Reference for error message [▶ 1367]</p> <input type="checkbox"/> IIMP102
Restriction Type Balance to	<p>Select the restriction type code of the securities position to which the securities have to be restricted/ unrestricted from the drop-down menu.</p> <p>Reference for error message [▶ 1367]:</p> <input type="checkbox"/> IIMP102

Intra-Position Movements – Search Criteria	
	The securities balance type of 'Balance to' must be different from the securities balance type of 'Balance from'.
Intended Settlement Date - from	Enter the lower bound of the search range for the intended settlement date or use the <i>calendar</i> icon. Required format is: YYYY-MM-DD Reference for error message [▶ 1367]: <input type="checkbox"/> QMPC012
Intended Settlement Date - to	Enter the upper bound of the search range for the intended settlement date or use the <i>calendar</i> icon. Required format is: YYYY-MM-DD Reference for error message [▶ 1367]: <input type="checkbox"/> QMPC012
Actual Settlement Date - from	Enter the lower bound of the search range for the actual settlement date or use the <i>calendar</i> icon. Required format is: YYYY-MM-DD hh:mm:ss References for error messages [▶ 1367]: <input type="checkbox"/> QMPC013 <input type="checkbox"/> QMPC014
Actual Settlement Date - to	Enter the upper bound of the search range for the actual settlement date or use the <i>calendar</i> icon. Required format is: YYYY-MM-DD hh:mm:ss Reference for error message [▶ 1367]: <input type="checkbox"/> QMPC014
Entry Date and Time – from	Enter the lower bound of the search range for the entry date and time or use the <i>calendar</i> icon. Required format is: YYYY-MM-DD hh:mm:ss References for error messages [▶ 1367]: <input type="checkbox"/> QMPC015 <input type="checkbox"/> QMPC073
Entry Date and Time – to	Enter the upper bound of the search range for the entry date and time or use the <i>calendar</i> icon. Required format is: YYYY-MM-DD hh:mm:ss References for error messages [▶ 1367]: <input type="checkbox"/> QMPC015

Intra-Position Movements – Search Criteria	
	<input type="checkbox"/> QMPC095
Quantity or Nominal of Securities – from	<p>Enter the lower bound of the search range for the quantity or nominal of securities.</p> <p>Required format is: max. 18,6 digits incl. decimal point</p> <p>Reference for error message [▶ 1367]:</p> <input type="checkbox"/> QMPC006
Quantity or Nominal of Securities – to	<p>Enter the upper bound of the search range for the quantity or nominal of securities.</p> <p>Required format is: max. 18,6 digits incl. decimal point</p> <p>Reference for error message [▶ 1367]:</p> <input type="checkbox"/> QMPC006
Settlement Type	<p>Select the type of settlement foreseen for the securities from the possible values:</p> <input type="checkbox"/> Unit <input type="checkbox"/> Face amount
Settlement Status	<p>Select the settlement status of the settlement restriction from the possible values:</p> <input type="checkbox"/> All (default value) <input type="checkbox"/> Unsettled <input type="checkbox"/> Settled <input type="checkbox"/> Partially settled
ISO Settlement status	<p>Select the settlement status of the settlement restriction from the possible values:</p> <input type="checkbox"/> All (default value) <input type="checkbox"/> Pending <input type="checkbox"/> Failing <p>If value 'Settlement Status' field is set to 'Settled' or 'Cancellation Status' field is set to 'Cancelled', this field is disabled.</p>
Cancellation Status	<p>Select the cancellation status of the settlement restriction from the possible values:</p> <input type="checkbox"/> All (default value) <input type="checkbox"/> Cancelled <input type="checkbox"/> Not cancelled

Intra-Position Movements – Search Criteria	
Intra-Position Movements - List	
Actor Reference	Shows the identification of the reference assigned for a settlement restriction by the instructing party.
Instructing Party BIC	Shows the BIC of the instructing party.
Instructing Party Parent BIC	Shows the parent BIC of the instructing party.
Securities Account Number	Shows the number of the securities account.
ISIN	Shows the ISIN of the securities.
Securities Description	Shows the textual description of a security instrument.
Original Quantity	Shows the quantity of financial instrument in units, original face amount or current face amount.
Settlement Unit	Shows the quantity type of the original settlement quantity from the possible values: <ul style="list-style-type: none"> <input type="checkbox"/> Units <input type="checkbox"/> Face amount
Restriction Type – Balance from	Shows the code specified by the CSD to identify the restriction.
Restriction Type - Balance to	Shows the code specified by the CSD to identify the restriction.
Restriction Reference	Shows the unique identification of a restricted securities position.
Settlement Status	Shows the current settlement status of the settlement restriction from the possible values: <ul style="list-style-type: none"> <input type="checkbox"/> Unsettled <input type="checkbox"/> Settled <input type="checkbox"/> Partially settled
Cancellation Status	Shows the current cancellation status of the settlement restriction from the possible values: <ul style="list-style-type: none"> <input type="checkbox"/> Cancelled <input type="checkbox"/> Not cancelled

Buttons

Search	<p>This function enables you to start a search according to the criteria entered. The results are displayed in a list on the same screen.</p> <p>If the search retrieves a single record, the <i>details</i> screen is displayed directly.</p> <p>Next screens:</p> <ul style="list-style-type: none"><input type="checkbox"/> <i>Intra-position movements – search/list</i> screen<input type="checkbox"/> <i>Intra-position movement – details</i> screen [▶ 144] <p>References for error messages [▶ 1367]:</p> <ul style="list-style-type: none"><input type="checkbox"/> QMPC006<input type="checkbox"/> QMPC012<input type="checkbox"/> QMPC013<input type="checkbox"/> QMPC014<input type="checkbox"/> QMPC015<input type="checkbox"/> QMPC018<input type="checkbox"/> QMPC030<input type="checkbox"/> QMPC032<input type="checkbox"/> QMPC048<input type="checkbox"/> QMPC073<input type="checkbox"/> QMPC084<input type="checkbox"/> QMPC095
Reset	<p>This function enables you to set default search criteria and blanks out all optional criteria</p> <p>Next screen:</p> <ul style="list-style-type: none"><input type="checkbox"/> <i>Intra-position movements– search/list</i> screen
New	<p>This function enables you to create a new settlement restriction on securities.</p> <p>Next screen:</p> <ul style="list-style-type: none"><input type="checkbox"/> <i>Intra-position movement – new</i> screen [▶ 151]
Details	<p>This function enables you to display the details of the selected settlement restriction on securities.</p> <p>Next screen:</p> <ul style="list-style-type: none"><input type="checkbox"/> <i>Intra-position movement – details</i> screen [▶ 144]

2.2.2.12 Intra-Position Movement - Details Screen

Context of Usage	<p>This screen displays detailed information on the selected settlement restriction on securities. You can check the data and proceed further by clicking on the buttons below.</p> <p>This screen is not relevant for CB users.</p>
Screen Access	<ul style="list-style-type: none">□ <code>Securities >> Settlement >> Intra-Position Movements >> Intra-position movements – search/list</code> screen >> Click on the <i>search</i> and/or <i>details</i> button
Privileges	<p>To use this screen you need the following privilege:</p> <ul style="list-style-type: none">□ Intra-position movements query
References	<p>User Instructions Part</p> <p>This screen is part of the following business scenarios:</p> <ul style="list-style-type: none">□ Add a link for a settlement restriction on securities [▶ 798]□ Amend the priority for a settlement restriction on securities [▶ 801]□ Cancel a settlement restriction on securities [▶ 814]□ Copy a settlement restriction on securities [▶ 788]□ Remove a link for a settlement restriction on securities [▶ 803]□ View settlement restriction on securities details [▶ 791] <p>Business Functionality Document</p> <p>This screen corresponds to the following business function:</p> <ul style="list-style-type: none">□ Display instruction details (T2S.GUI.SESE.INX.0030)

Screenshot

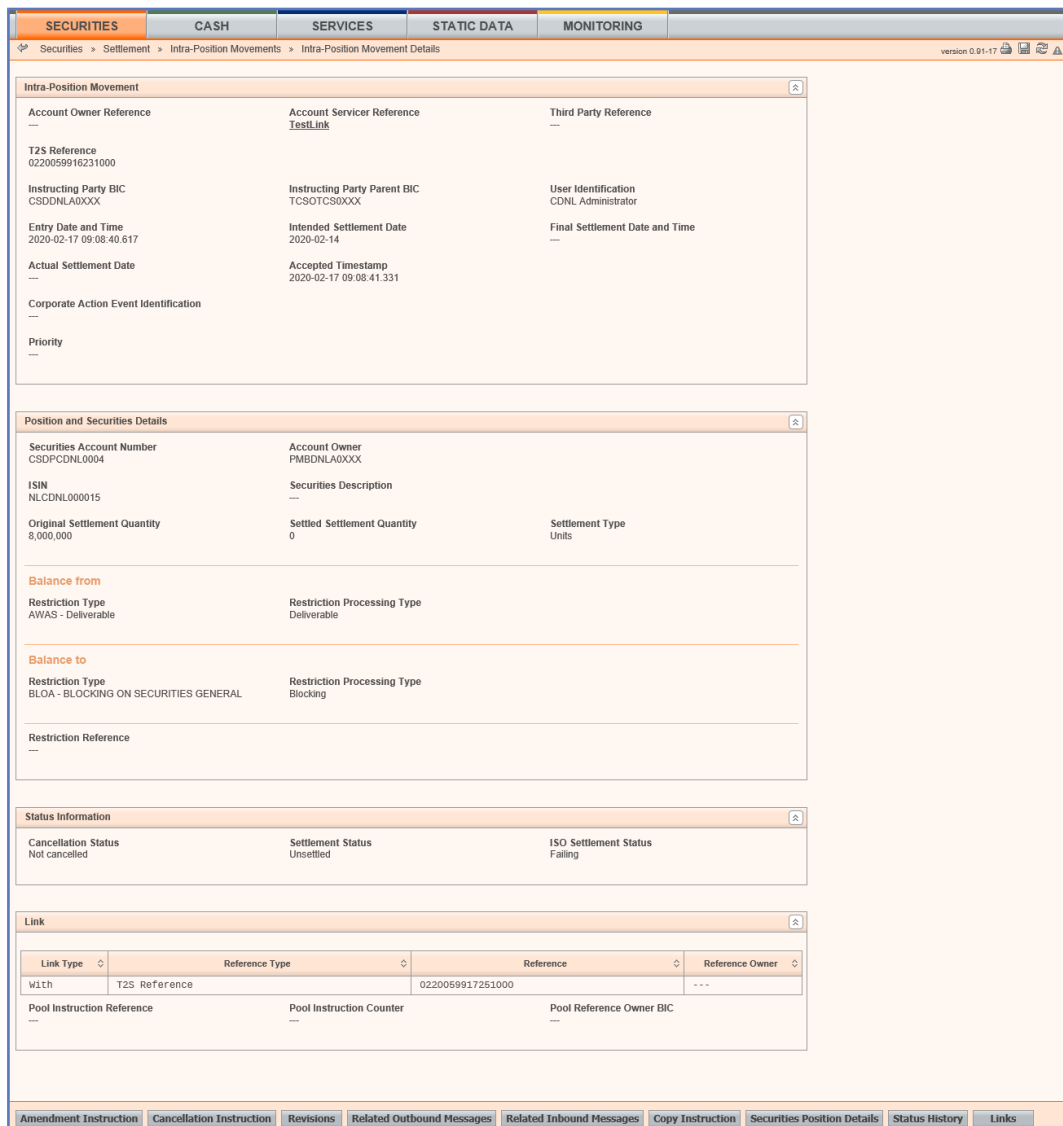

Illustration 51: Intra-position movement - details screen

Field

Description

Intra-Position Movement	
Securities Account Owner Reference	Shows the reference assigned by the T2S party to the settlement restriction. Only one of the three references exists. The reference in bold and underlined font is the actor reference owned by the instructing party.
Securities Account Servicer Reference	Shows the reference assigned by the CB to the settlement restriction on securities. Only one of the three references exists. The reference in bold and underlined font is the actor reference owned by the instructing party.
Third Party Reference	Shows the reference assigned by a third party to the instruction.

Intra-Position Movement	
	Only one of the three references exists. The reference in bold and underlined font is the actor reference owned by the instructing party.
T2S Reference	Shows the identification of the reference assigned for a settlement restriction on securities by T2S.
Instructing Party BIC	Shows the BIC of the instructing party.
Instructing Party Parent BIC	Shows the parent BIC of the instructing party.
User Identification	Shows user identification of the sending party.
Entry Date and Time	Shows the date and time when the instruction has entered in T2S. Displayed format is: YYYY-MM-DD hh:mm:ss:µsµsµsµsµs
Intended Settlement Date	Shows the date at which the instruction becomes eligible to be submitted to settlement. Displayed format is: YYYY-MM-DD
Final Settlement Date and Time	Shows the business date and the calendar time when the settlement restriction has been totally settled. Displayed format is: YYYY-MM-DD hh:mm:ss:µsµsµsµsµs
Actual Settlement Date and Time	Shows the business date and the calendar time when the settlement restriction has been settled or totally settled. Displayed format is: YYYY-MM-DD hh:mm:ss:µsµsµsµsµs
Accepted Timestamp (SF1)	Shows the accepted timestamp of the settlement restriction. Displayed format is: YYYY-MM-DD hh:mm:ss:µsµsµsµsµs
Corporate Action Event Identification	Shows the identification assigned by the account servicer to unambiguously identify a corporate action event.
Priority	Shows the level of priority assigned by T2S or by the T2S actor from the possible values: <input type="checkbox"/> Normal <input type="checkbox"/> High <input type="checkbox"/> Top <input type="checkbox"/> Reserved
Position and Securities Details	
Securities Account Number	Shows the securities account of the settlement restriction on securities.

Intra-Position Movement	
Securities Account Owner BIC	Shows the BIC of the owner of the securities account.
ISIN	Shows the ISIN of the securities account.
Securities Description	Shows the textual description of a securities account.
Original Settlement Quantity	Shows the total quantity of securities to be settled.
Settled Settlement Quantity	Shows the settled quantity of securities.
Settlement Type	Shows the type of settlement foreseen for the securities from the possible values: <input type="checkbox"/> Units <input type="checkbox"/> Face amount
Balance from	
Restriction Type	Shows the code defined in reference data to identify the restriction.
Restriction Processing Type	Shows the type of processing T2S shall apply for the restriction from the possible values: <input type="checkbox"/> Rejection <input type="checkbox"/> Reservation <input type="checkbox"/> Blocking <input type="checkbox"/> Earmarking <input type="checkbox"/> Earmarking for auto-collateralisation <input type="checkbox"/> Deliverable <input type="checkbox"/> Collateralised <input type="checkbox"/> CoSD blocking
Balance to	
Restriction Type	Shows the code defined in reference data to identify the restriction.
Restriction Processing Type	Shows the type of processing T2S shall apply for the restriction from the possible values: <input type="checkbox"/> Rejection <input type="checkbox"/> Reservation <input type="checkbox"/> Blocking

Intra-Position Movement	
	<input type="checkbox"/> Earmarking <input type="checkbox"/> Earmarking for auto-collateralisation <input type="checkbox"/> Deliverable <input type="checkbox"/> Collateralised <input type="checkbox"/> CoSD blocking
Restriction Reference	Shows the unique identification of a restriction reference.
Status Information	
Cancellation Status	Shows the current cancellation status of the settlement restriction from the possible values: <input type="checkbox"/> Cancelled <input type="checkbox"/> Not cancelled
Settlement Status	Shows the current settlement status of the settlement restriction from the possible values: <input type="checkbox"/> Settled <input type="checkbox"/> Partially settled <input type="checkbox"/> Unsettled
ISO Settlement Status	Shows the current ISO settlement status of the settlement restriction from the possible values: <input type="checkbox"/> Pending <input type="checkbox"/> Failing
Link	
Link Type	Shows the type of link of the instruction your restriction is linked with from the possible values: <input type="checkbox"/> After <input type="checkbox"/> Before <input type="checkbox"/> With <input type="checkbox"/> Info
Reference Type	Shows the reference type of the instruction to be linked/unlinked to from the possible values: <input type="checkbox"/> Account owner settlement instruction reference <input type="checkbox"/> Account owner settlement instruction reference <input type="checkbox"/> Account owner intra balance movement reference

Intra-Position Movement	
	<input type="checkbox"/> Account owner intra position movement reference <input type="checkbox"/> Account servicer reference <input type="checkbox"/> Third party reference <input type="checkbox"/> T2S reference
Reference	Shows the identification of the instruction to be linked/un-linked to.
Reference Owner	Shows the BIC of the instructing party of the instruction to be linked/unlinked to. This field is only filled in if the 'Reference Type' is set to any value different than 'T2S Reference'.
Pool Instruction reference	Shows the collective reference identifying a set of messages.
Pool Instruction Counter	Shows the maximum number of instructions included in the pool.
Pool Reference Owner BIC	Shows the BIC of the owner of the Pool Instruction Reference

Buttons

Amendment Instruction	This function enables you to create a new amendment instruction for your settlement restriction on securities. This button is not available in case any status of the settlement restriction on securities does not allow the creation of the amendment instruction. Next screen: <input type="checkbox"/> <i>Amendment securities instruction - new</i> screen [▶ 103]
Cancellation Instruction	This function enables you to create a new cancellation instruction for your settlement restriction on securities. This button is not available in case any status of the settlement restriction on securities does not allow the creation of the cancellation instruction. Next screen: <input type="checkbox"/> <i>Cancellation securities instruction - new</i> screen [▶ 117]
Revisions	This function enables you to display the revisions of the settlement restriction on securities. Next screen: <input type="checkbox"/> <i>Revisions/audit trail – list</i> screen [▶ 662]

Related Outbound Messages	<p>This function enables you to display the outbound messages related to the settlement restriction on securities.</p> <p>In case the settlement restriction on securities is linked to more than 1 outbound message, the <i>outbound messages - search/list</i> screen is displayed.</p> <p>In case the query only returns 1 valid message, the <i>outbound message – details</i> screen is displayed directly.</p> <p>Next screens:</p> <ul style="list-style-type: none"><input type="checkbox"/> <i>Outbound messages – search/list</i> screen [646]<input type="checkbox"/> <i>Outbound message – details</i> screen [▶ 654]
Related Inbound Messages	<p>This function enables you to display the inbound messages related to the settlement restriction on securities.</p> <p>In case the settlement restriction on securities is linked to more than 1 inbound message, the <i>inbound messages - search/list</i> screen is displayed.</p> <p>In case the query only returns 1 valid message, the <i>inbound message – details</i> screen is displayed directly.</p> <p>Next screens:</p> <ul style="list-style-type: none"><input type="checkbox"/> <i>Inbound messages – search/list</i> screen [▶ 629]<input type="checkbox"/> <i>Inbound message – details</i> screen [▶ 636]
Copy Instruction	<p>This function enables you to copy fields to create a new settlement restriction on securities with the same attributes.</p> <p>Next screen:</p> <ul style="list-style-type: none"><input type="checkbox"/> <i>Intra-position movement – new</i> screen
Securities Position Details	<p>This function enables you to display the position details related to the settlement restriction on securities.</p> <p>All the position details from the ‘Settlement Restriction on Securities’ are shown, including the restriction type from the ‘Balance From’ and the ‘Balance to’.</p> <p>Next screen:</p> <ul style="list-style-type: none"><input type="checkbox"/> <i>Securities position - details</i> screen [▶ 174]
Status History	<p>This function enables you to display the status history of the settlement restriction on securities.</p> <p>Next screen:</p>

	<input type="checkbox"/> <i>Status history – details</i> screen [▶ 267]
Links	<p>This function enables you to display all the links data preventing settlement at the moment when the request is performed.</p> <p>This button is not available in the following cases:</p> <ul style="list-style-type: none"> <input type="checkbox"/> Cancellation Status = “cancelled” <input type="checkbox"/> Settlement Status=“settled” <p>Next screen:</p> <ul style="list-style-type: none"> <input type="checkbox"/> Links Preventing Settlement-screen

2.2.2.13 Intra-Position Movement - New Screen

Context of Usage

The screen contains a number of fields regarding settlement restrictions on securities (intra-position movement). You can enter new data. Afterwards you can proceed further by clicking on the buttons below.

You can use this screen either in 2-eyes or in 4-eyes mode.

This screen is not relevant for CB users.

Screen Access

Securities >> Settlement >> Intra-Position Movements >> *Intra position movements – search/list* screen >> Click on the *new* button

Privileges

To use this screen you need the following privileges [▶ 1217]:

- Send new instruction using a specific instructing party
- Send new settlement instruction/settlement restriction on securities either on a securities account or on behalf of an external CSD
- Link to an instruction/pool reference belonging to a specific party
- Unblock CoSD securities blocking related to cancelled CoSD settlement instructions on behalf of the relevant CSD in T2S

References

User Instructions Part

This screen is part of the following business scenarios:

- Enter a settlement restriction on securities [▶ 786]
- Copy a settlement restriction on securities [▶ 788]

Business Functionality Document

This screen corresponds to the following business function:

- Add settlement instruction or settlement restriction (T2S.GUI.SESE.INX.0070)

Screenshot

Illustration 52: Intra-position movement - new screen

Field Description

Intra-Position Movement	
Actor Reference*	Enter the identification of the T2S actor. Required format is: max. 16 characters (SWIFT-x-red) References for error messages [▶ 1343]: <input type="checkbox"/> MVDC003 <input type="checkbox"/> MVDC005 <input type="checkbox"/> MVDC007 <input type="checkbox"/> MVDC015 <input type="checkbox"/> MVDC017 <input type="checkbox"/> MVDC019 <input type="checkbox"/> MVDC022 <input type="checkbox"/> MVDC023 <input type="checkbox"/> MVSR705 <input type="checkbox"/> MVSR708
Instructing Party Parent BIC	Select the parent BIC of the instructing party from the drop-down menu or search via the <i>magnifier</i> icon.

Intra-Position Movement	
	<p>If the instructing party is entered, the instructing party parent must also be entered.</p> <p>Required format is: max. 11 characters (SWIFT-x)</p> <p>References for error messages [▶ 1343]:</p> <ul style="list-style-type: none"><input type="checkbox"/> MVCP120<input type="checkbox"/> MVCV110<input type="checkbox"/> MVCV230<input type="checkbox"/> MVCV290<input type="checkbox"/> MVDC003<input type="checkbox"/> MVDC005<input type="checkbox"/> MVDC007<input type="checkbox"/> MVDC015<input type="checkbox"/> MVDC017<input type="checkbox"/> MVDC019<input type="checkbox"/> MVDC022<input type="checkbox"/> MVDC023<input type="checkbox"/> MVDC025<input type="checkbox"/> MVIC310<input type="checkbox"/> MVIC312<input type="checkbox"/> MVIC314
Instructing Party BIC	<p>Select the BIC of the instructing party from the drop-down menu or search via the <i>magnifier</i> icon.</p> <p>In case the instructing party is not entered, the instructing party informed to the back end module will be the party you belong to.</p> <p>If the instructing party parent is entered, the instructing party must also be entered.</p> <p>Required format is: max. 11 characters (SWIFT-x)</p> <p>References for error messages [▶ 1343]:</p> <ul style="list-style-type: none"><input type="checkbox"/> MVCP097<input type="checkbox"/> MVCP099<input type="checkbox"/> MVCP120<input type="checkbox"/> MVCV110

Intra-Position Movement	
	<ul style="list-style-type: none"> <input type="checkbox"/> MVCV230 <input type="checkbox"/> MVCV290 <input type="checkbox"/> MVDC003 <input type="checkbox"/> MVDC005 <input type="checkbox"/> MVDC007 <input type="checkbox"/> MVDC015 <input type="checkbox"/> MVDC017 <input type="checkbox"/> MVDC019 <input type="checkbox"/> MVDC022 <input type="checkbox"/> MVDC023 <input type="checkbox"/> MVDC025 <input type="checkbox"/> MVIC310 <input type="checkbox"/> MVIC312 <input type="checkbox"/> MVIC314 <input type="checkbox"/> MVSP210
Intended Settlement Date*	<p>Enter the date at which the instruction becomes eligible to be submitted to settlement or use the <i>calendar</i> icon.</p> <p>Required format is: YYYY-MM-DD</p> <p>References for error messages [1343]:</p> <ul style="list-style-type: none"> <input type="checkbox"/> MVCV110 <input type="checkbox"/> MVCV124 <input type="checkbox"/> MVCV230 <input type="checkbox"/> MVCV284 <input type="checkbox"/> MVCV302 <input type="checkbox"/> MVCV304 <input type="checkbox"/> MVIC306 <input type="checkbox"/> MVIC310 <input type="checkbox"/> MVIC312 <input type="checkbox"/> MVLI819 <input type="checkbox"/> MVLI820 <input type="checkbox"/> MVLI821 <input type="checkbox"/> MVLI822

Intra-Position Movement	
	<ul style="list-style-type: none"><input type="checkbox"/> MVLI823<input type="checkbox"/> MVLI824<input type="checkbox"/> MVLI834<input type="checkbox"/> MVLI835<input type="checkbox"/> MVLI836<input type="checkbox"/> MVRR904<input type="checkbox"/> MVRR991<input type="checkbox"/> MVSD402<input type="checkbox"/> MVSD405
Corporate Action Event	<p>Enter the identification assigned by the account servicer to unambiguously identify a corporate action event.</p> <p>Required format is: max. 16 characters (SWIFT-x-red)</p> <p>References for error messages [▶ 1343]:</p> <ul style="list-style-type: none"><input type="checkbox"/> MVSQ607<input type="checkbox"/> MVSQ611
Priority	<p>Select the level of priority assigned to the instruction from the possible values:</p> <ul style="list-style-type: none"><input type="checkbox"/> Empty (default value)<input type="checkbox"/> Normal<input type="checkbox"/> High<input type="checkbox"/> Reserved <p>Reference for error message [▶ 1343]:</p> <ul style="list-style-type: none"><input type="checkbox"/> MVSP210
Securities Account Number*	<p>Select the technical identification of the account to or from which a securities entry is made.</p> <p>Required format is: max. 35 characters (SWIFT-x)</p> <p>References for error messages [▶ 1343]:</p> <ul style="list-style-type: none"><input type="checkbox"/> MVCP044<input type="checkbox"/> MCV004<input type="checkbox"/> MCV124<input type="checkbox"/> MCV284<input type="checkbox"/> MCV285<input type="checkbox"/> MCV290

Intra-Position Movement	
	<input type="checkbox"/> MRRR922
ISIN*	<p>Select the ISIN of the security from the drop-down menu.</p> <p>References for error messages [▶ 1343]:</p> <input type="checkbox"/> MVCV206 <input type="checkbox"/> MVCV302 <input type="checkbox"/> MVCV304 <input type="checkbox"/> MVIC306 <input type="checkbox"/> MVIC310 <input type="checkbox"/> MVIC312 <input type="checkbox"/> MVIC314 <input type="checkbox"/> MRRR923 <input type="checkbox"/> MVSQ603 <input type="checkbox"/> MVSQ605 <input type="checkbox"/> MVSQ607
Securities Short Name	Shows the description of the selected ISIN.
Securities Account Owner BIC	<p>Enter the BIC of the securities account owner.</p> <p>Required format is: max. 11 characters (SWIFT-x)</p> <p>Reference for error message [▶ 1343]:</p> <input type="checkbox"/> MVCV285
Quantity	<p>Enter the quantity stated in the settlement restriction on securities.</p> <p>Required format is:</p> <p>For settlement type = Unit, max. 15 digit(s) incl. decimal point (thereof max. 14 decimal places)</p> <p>For settlement type = Face Amount, max. 15 digit(s) incl. decimal point (thereof max. 5 decimal places)</p> <p>This field will be displayed as soon as you select an ISIN.</p> <p>References for error messages [▶ 1343]:</p> <input type="checkbox"/> MVCV608 <input type="checkbox"/> MVSQ603 <input type="checkbox"/> MVSQ605 <input type="checkbox"/> MVSQ607

Intra-Position Movement	
	<input type="checkbox"/> MVSQ613
Settlement Type	<p>Shows the type of settlement foreseen for the securities from the possible values:</p> <input type="checkbox"/> Unit <input type="checkbox"/> Face Amount Reference for error message [▶ 1343]: <input type="checkbox"/> MVSQ613
Restriction Type - Balance from*	<p>You can choose to either enter the 'Restriction Type -Balance from' or to select it from the suggested items in the drop-down menu.</p> <p>References for error messages [▶ 1343]:</p> <input type="checkbox"/> MVRR995 <input type="checkbox"/> MVRR902 <input type="checkbox"/> MVRR904 <input type="checkbox"/> MVRR907 <input type="checkbox"/> MVRR908 <input type="checkbox"/> MVRR909 <input type="checkbox"/> MVRR915 <input type="checkbox"/> MVRR921 <input type="checkbox"/> MVRR954 <input type="checkbox"/> MVRR970 <input type="checkbox"/> MVRR971 <input type="checkbox"/> MVRR979 <input type="checkbox"/> MVRR980 <input type="checkbox"/> MVRR981 <input type="checkbox"/> MVCP097 <p>All the possible values stored in SD and available according the privileges will be shown.</p>
Restriction Type - Balance to*	<p>You can choose to either enter the 'Restriction Type -Balance to' or to select it from the suggested items in the drop-down menu.</p> <p>References for error messages [▶ 1343]:</p> <input type="checkbox"/> MVRR907

Intra-Position Movement	
	<ul style="list-style-type: none"> <input type="checkbox"/> MVRR908 <input type="checkbox"/> MVRR909 <input type="checkbox"/> MVRR914 <input type="checkbox"/> MVRR921 <input type="checkbox"/> MVRR970 <input type="checkbox"/> MVRR971 <input type="checkbox"/> MVRR979 <input type="checkbox"/> MVRR980 <input type="checkbox"/> MVRR981 <input type="checkbox"/> MVRR990 <input type="checkbox"/> MVRR991 <p>All the possible values stored in SD and available according the privileges will be shown.</p>
Restriction Reference	<p>Enter the restriction reference applying on securities. Required format is: max. 16 characters (SWIFT-x-red) References for error messages [▶ 1343]:</p> <ul style="list-style-type: none"> <input type="checkbox"/> MVRR919 <input type="checkbox"/> MVRR921 <input type="checkbox"/> MVRR922 <input type="checkbox"/> MVRR923 <input type="checkbox"/> MVRR954 <input type="checkbox"/> MVRR970 <input type="checkbox"/> MVRR971 <input type="checkbox"/> MVRR980 <input type="checkbox"/> MVRR981 <input type="checkbox"/> MVRR982
Link	
Link Type	<p>Select a link processing position from the possible values:</p> <ul style="list-style-type: none"> <input type="checkbox"/> After (default value) <input type="checkbox"/> Before <input type="checkbox"/> With <input type="checkbox"/> Info

Intra-Position Movement	
	<p>References for error messages [▶ 1343]:</p> <ul style="list-style-type: none"> <input type="checkbox"/> MVLI805 <input type="checkbox"/> MVLI806 <input type="checkbox"/> MVLI807 <input type="checkbox"/> MVLI819 <input type="checkbox"/> MVLI820 <input type="checkbox"/> MVLI821 <input type="checkbox"/> MVLI822 <input type="checkbox"/> MVLI823 <input type="checkbox"/> MVLI824 <input type="checkbox"/> MVLI834 <input type="checkbox"/> MVLI835 <input type="checkbox"/> MVLI836 <input type="checkbox"/> MVLI852 <input type="checkbox"/> MVLI858 <input type="checkbox"/> MVLI861 <input type="checkbox"/> MVLI864 <input type="checkbox"/> MVLI866 <input type="checkbox"/> MVLI873 <input type="checkbox"/> MVLI876 <input type="checkbox"/> MVCP016 <input type="checkbox"/> MVLI855 <p>This field is also available as a show field for existing records.</p>
Reference Type	<p>Select the reference type of the instruction to be linked/unlinked to from the possible values:</p> <ul style="list-style-type: none"> <input type="checkbox"/> Account Owner Settlement Instruction Reference <input type="checkbox"/> Account Owner Settlement Instruction Reference <input type="checkbox"/> Account Owner Intra Balance Movement Reference <input type="checkbox"/> Account Owner Intra Position Movement Reference <input type="checkbox"/> Account Servicer Reference <input type="checkbox"/> Third Party reference

Intra-Position Movement	
	<input type="checkbox"/> T2S reference Required format is: max. 35 characters (SWIFT-x) Reference for error message [▶ 1343]: <input type="checkbox"/> MVCP099 This field is also available as a show field for existing records.
Reference	Enter the identification of the instruction to be linked/unlinked to. Required format is: max. 16 characters (SWIFT-x-red) References for error messages [▶ 1343]: <input type="checkbox"/> MVCP016 <input type="checkbox"/> MVCP099 <input type="checkbox"/> MVLI873 <input type="checkbox"/> MVLI869 This field is also available as a show field for existing records.
Reference Owner	Enter the BIC of the instructing party of the instruction to be linked/unlinked to Required format is: max. 11 characters (SWIFT-x) This field is also available as a show field for existing records.
Options	Information on functions (icons) can be found in Common Buttons and Icons [▶ 43].
List	
Pool Instruction Identification	Enter the collective reference identifying a set of messages. Required format is: max. 16 characters (SWIFT-x-red) References for error messages [▶ 1343]: <input type="checkbox"/> MVCP016 <input type="checkbox"/> MVLI836 <input type="checkbox"/> MVLI846 <input type="checkbox"/> MVLI848 <input type="checkbox"/> MVLI868 <input type="checkbox"/> MVLI876

Intra-Position Movement	
Pool Instruction Counter	<p>Enter the pool identification.</p> <p>Required format is: Integer</p> <p>Reference for error message [▶ 1343]:</p> <ul style="list-style-type: none"> <input type="checkbox"/> MVL1844 <p>This field becomes mandatory when the 'Pool Instruction Identification' is filled in.</p>
Pool Reference Owner BIC	<p>Enter the BIC of the owner of the Pool Instruction Reference.</p> <p>The field 'Pool Reference Owner BIC' becomes mandatory when the field 'Pool Instruction Identification' is filled in.</p>

Buttons

Buttons	
Submit	<p>This function enables you to create a new intra-position movement instruction. Upon clicking on the <i>submit</i> button you will be asked to enter your PIN for digital signature purposes (NRO). With the entry of the PIN, T2S attaches a digital signature to the instruction entered by the T2S actor.</p> <p>Next screen:</p> <ul style="list-style-type: none"> <input type="checkbox"/> <i>Intra-position movements – search/list</i> screen [▶ 137] <p>References for error messages [▶ 1343]:</p> <ul style="list-style-type: none"> <input type="checkbox"/> MVCP015 <input type="checkbox"/> MVCP016 <input type="checkbox"/> MVCP044 <input type="checkbox"/> MVCP097 <input type="checkbox"/> MVCP099 <input type="checkbox"/> MVCP120 <input type="checkbox"/> MCV004 <input type="checkbox"/> MCV110 <input type="checkbox"/> MCV124 <input type="checkbox"/> MCV206 <input type="checkbox"/> MCV230 <input type="checkbox"/> MCV284 <input type="checkbox"/> MCV285

- MVCV290
- MVCV302
- MVCV304
- MVCV608
- MVDC003
- MVDC005
- MVDC007
- MVDC015
- MVDC017
- MVDC019
- MVDC022
- MVDC023
- MVDC025
- MVIC306
- MVIC310
- MVIC312
- MVIC314
- MVLI805
- MVLI806
- MVLI807
- MVLI819
- MVLI820
- MVLI821
- MVLI822
- MVLI823
- MVLI824
- MVLI834
- MVLI835
- MVLI836
- MVLI844
- MVLI846
- MVLI848

- MVLI852
- MVLI855
- MVLI858
- MVLI861
- MVLI864
- MVLI866
- MVLI868
- MVLI869
- MVLI873
- MVLI876
- MVRR902
- MVRR904
- MVRR907
- MVRR908
- MVRR909
- MVRR914
- MVRR915
- MVRR919
- MVRR921
- MVRR922
- MVRR923
- MVRR954
- MVRR970
- MVRR971
- MVRR979
- MVRR980
- MVRR981
- MVRR982
- MVRR990
- MVRR991
- MVRR995
- MVSD402

	<input type="checkbox"/> MVSD405 <input type="checkbox"/> MVSP210 <input type="checkbox"/> MVSQ603 <input type="checkbox"/> MVSQ605 <input type="checkbox"/> MVSQ607 <input type="checkbox"/> MVSQ611 <input type="checkbox"/> MVSQ613 <input type="checkbox"/> MVSR705 <input type="checkbox"/> MVSR706 <input type="checkbox"/> MVSR708
Cancel	<p>This function enables you to cancel the process and return to the previous screen.</p> <p>Next screen:</p> <input type="checkbox"/> <i>Intra-position movements – search/list screen</i> [▶ 137]
Reset	<p>This function enables you to set all fields to default value and blanks out all optional fields.</p> <p>Next screen:</p> <input type="checkbox"/> <i>Intra-position movement - new screen</i>

2.2.2.14 Maintenance Securities Instructions - Search/List Screen

Context of Usage

This screen contains a number of search fields. By inputting the relevant data, you can search for maintenance securities instructions. The search results will be displayed in a list. After selecting an entry, you can proceed further by clicking on the buttons below.

This screen is not relevant for CB users.

Screen Access

Securities >> Settlement >> Maintenance Securities Instructions >> *Maintenance securities instructions – search/list screen*

Privileges

To use this screen, you need the following privileges [▶ 1219]:

- Amendment instruction query for intra-position movements and settlement instructions
- Maintenance for intra-position movements and settlement instructions query
- Cancellation instruction query for intra-position movements and settlement instructions

References **User Instructions Part**

This screen is part of the following business scenarios:

- View amendment instruction for a settlement instruction details [▶ 752]
- View amendment instruction for a settlement restriction on securities details [▶ 805]
- View cancellation instruction for a settlement instruction details [▶ 770]
- View cancellation instruction for a settlement restriction on securities details [▶ 816]
- View hold/release instruction details [▶ 766]

Business Functionality Document

This screen corresponds to the following business function:

- Query instruction (T2S.GUI.SESE.INX.0010)
- Display instruction list (T2S.GUI.SESE.INX.0020)

Screenshot

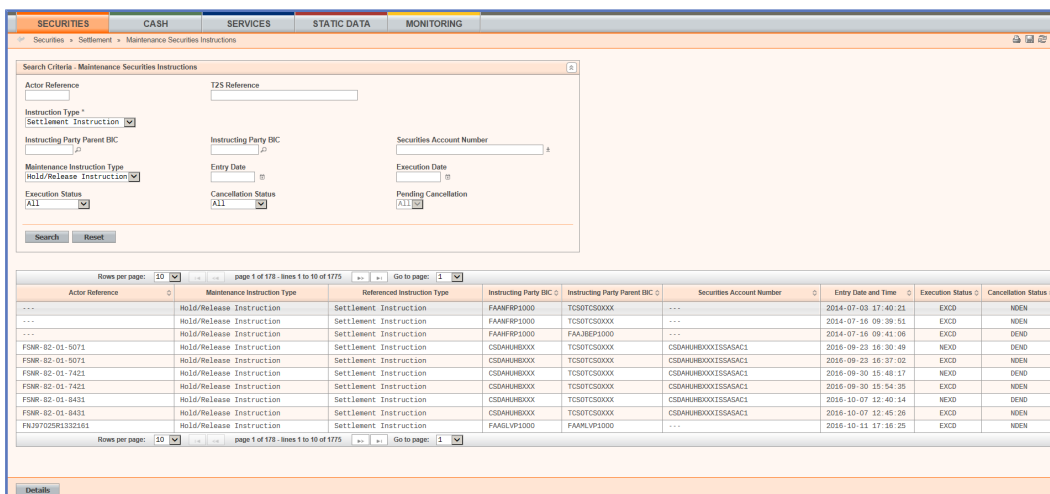

Illustration 53: Maintenance securities instructions - search/list screen

Field Description

Maintenance Securities Instructions – Search Criteria	
Actor Reference	Enter the identification assigned by the T2S actor. Required format is: max. 16 characters (SWIFT-x)
T2S Reference	Enter the identification of the reference assigned to the referenced instruction by T2S. Required format is: max. 16 characters (SWIFT-x)
Instruction Type	Select the instruction type of the maintenance securities instruction from the possible values: <ul style="list-style-type: none"> <input type="checkbox"/> Settlement Instruction (default value) <input type="checkbox"/> Intra-Position Movement <input type="checkbox"/> All

Maintenance Securities Instructions – Search Criteria	
Instructing Party BIC	<p>You can choose to either enter the BIC of the instructing party or to select it from the suggested items in the drop-down menu.</p> <p>Required format is: max. 11 characters (SWIFT-x)</p> <p>References for error messages [▶ 1371]:</p> <ul style="list-style-type: none"> <input type="checkbox"/> QMPC032 <input type="checkbox"/> QMPC084
Instructing Party Parent BIC	<p>You can choose to either enter the parent BIC of the instructing party or to select it from the suggested items in the drop-down menu.</p> <p>Required format is: max. 11 characters (SWIFT-x)</p> <p>References for error messages [▶ 1371]:</p> <ul style="list-style-type: none"> <input type="checkbox"/> QMPC048 <input type="checkbox"/> QMPC084
Securities Account Number	<p>You can choose to either enter the 'Securities Account Number' or to select it from the suggested items in the drop-down menu.</p> <p>Reference for error message [▶ 1371]:</p> <ul style="list-style-type: none"> <input type="checkbox"/> QMPC030
Maintenance Instruction Type*	<p>Select the type of the maintenance instruction from the possible values:</p> <ul style="list-style-type: none"> <input type="checkbox"/> Cancellation Instruction <input type="checkbox"/> Amendment Instruction <input type="checkbox"/> Hold/release Instruction (default value) <p>The value 'Hold/Release Instruction' cannot be selected if the 'Instruction Type' is 'Intra-Position Movement'.</p>
Entry Date	<p>Enter the date when the maintenance instruction was created in T2S or use the <i>calendar</i> icon.</p> <p>Required format is: YYYY-MM-DD</p> <p>Reference for error message [▶ 1371]:</p> <ul style="list-style-type: none"> <input type="checkbox"/> QMPC073
Execution Date	<p>Enter the business date when the maintenance instruction has been executed or use the <i>calendar</i> icon.</p> <p>Required format is: YYYY-MM-DD</p>

Maintenance Securities Instructions – Search Criteria	
	References for error messages [▶ 1371]: <input type="checkbox"/> QMPC016 <input type="checkbox"/> QMPC073
Execution Status	Select the execution status of the maintenance instruction from the possible values: <input type="checkbox"/> All (default value) <input type="checkbox"/> Not Executed <input type="checkbox"/> Executed
Cancellation Status	Select the cancellation status of the maintenance instruction from the possible values: <input type="checkbox"/> All (default value) <input type="checkbox"/> Denied <input type="checkbox"/> Not Denied
Pending Cancellation	Select the pending cancellation status of the maintenance instruction (only for cancellation instruction) from the possible values: <input type="checkbox"/> All (default value) <input type="checkbox"/> Yes <input type="checkbox"/> No
Maintenance Securities Instructions - List	
Actor Reference	Shows the identification assigned by the T2S Actor.
Maintenance Instruction Type	Shows the type of the maintenance instruction from the possible values: <input type="checkbox"/> Amendment instruction <input type="checkbox"/> Cancellation instruction <input type="checkbox"/> Hold/release instruction
Referenced Instruction Type	Shows the type of the referenced instruction from possible values: <input type="checkbox"/> Settlement instruction <input type="checkbox"/> Intra-position movement
Instructing Party BIC	Shows the BIC of the instructing party of the referenced instruction.
Instructing Party Parent BIC	Shows the parent BIC of the instructing party of the referenced instruction.

Maintenance Securities Instructions – Search Criteria	
Securities Account Number	Shows the number of the securities account.
Entry Date and Time	Shows the date and time when the maintenance instruction has been created. Displayed format is: YYYY-MM-DD hh:mm:ss
Execution Status	Shows the execution status of the maintenance instruction from the possible values: <input type="checkbox"/> Not executed <input type="checkbox"/> Executed
Cancellation Status	Shows the cancellation status of the maintenance instruction from the possible values: <input type="checkbox"/> Not denied <input type="checkbox"/> Denied

Buttons

Buttons	
Search	<p>This function enables you to start a search according to the criteria entered. The results are displayed in a list on the next screen.</p> <p>If the search retrieves a single record, the <i>details</i> screen is displayed directly.</p> <p>Next screens:</p> <ul style="list-style-type: none"> <input type="checkbox"/> <i>Maintenance securities instruction – search/list</i> screen <input type="checkbox"/> <i>Amendment securities instruction – details</i> screen [▶ 98] <input type="checkbox"/> <i>Cancellation securities instruction – details</i> screen [▶ 113] <input type="checkbox"/> <i>Hold/release instruction – details</i> screen [▶ 122] <p>References for error messages [▶ 1371]:</p> <ul style="list-style-type: none"> <input type="checkbox"/> QMPC016 <input type="checkbox"/> QMPC030 <input type="checkbox"/> QMPC032 <input type="checkbox"/> QMPC048 <input type="checkbox"/> QMPC073 <input type="checkbox"/> QMPC084

Reset	This function enables you to set default search criteria and blanks out all optional criteria. Next screen: <input type="checkbox"/> <i>Maintenance securities instruction – search/list</i> screen
Details	This function enables you to display the details of the selected maintenance instruction. Next screens: <input type="checkbox"/> <i>Amendment securities instruction – details</i> screen [▶ 98] <input type="checkbox"/> <i>Cancellation securities instruction – details</i> screen [▶ 113] <input type="checkbox"/> <i>Hold/release instruction – details</i> screen [▶ 122]

2.2.2.15 Securities Positions - Search/List Screen

Context of Usage

This screen contains a number of search fields. By inputting the relevant data, you can search for securities positions. This screen retrieves information for any T2S securities account owner, i.e. a party which is a CSD, a CB (as CSD participant) or a settlement bank. The search results will be displayed in a list, which is sorted by the value of the 'Securities Account Number' column in ascending order (default setting). After selecting an entry, you can proceed further by clicking on the buttons below.

During the Start of Day, when the CRDM data is being replicated in the Settlement domain, only the securities positions data available at the End-of-Day of the previous business day is displayed at the screen. The securities positions data for the new business day is available as of the end of the CRDM data replication.{CR-634}

During night-time, the securities positions can only be displayed in-between night-time settlement sequences.

Screen Access

- Securities >> Securities Account >> Securities Positions
- Securities >> Settlement >> Securities Positions
- Monitoring >> Monitoring >> Securities Positions

Privileges

To use this screen, you need the following privilege [▶ 1227]:

- Securities account position query

References

User Instructions Part

This screen is part of the following business scenarios:

- View current securities positions and related postings [▶ 722]
- View current securities positions and related restrictions [▶ 723]
- View historic securities positions for a specific period [▶ 725]
- View historic securities positions for a specific date [▶ 724]

Business Functionality Document

This screen corresponds to the following business function:

- Display securities account positions (T2S.GUI.SESE.POS.0020)

Screenshot

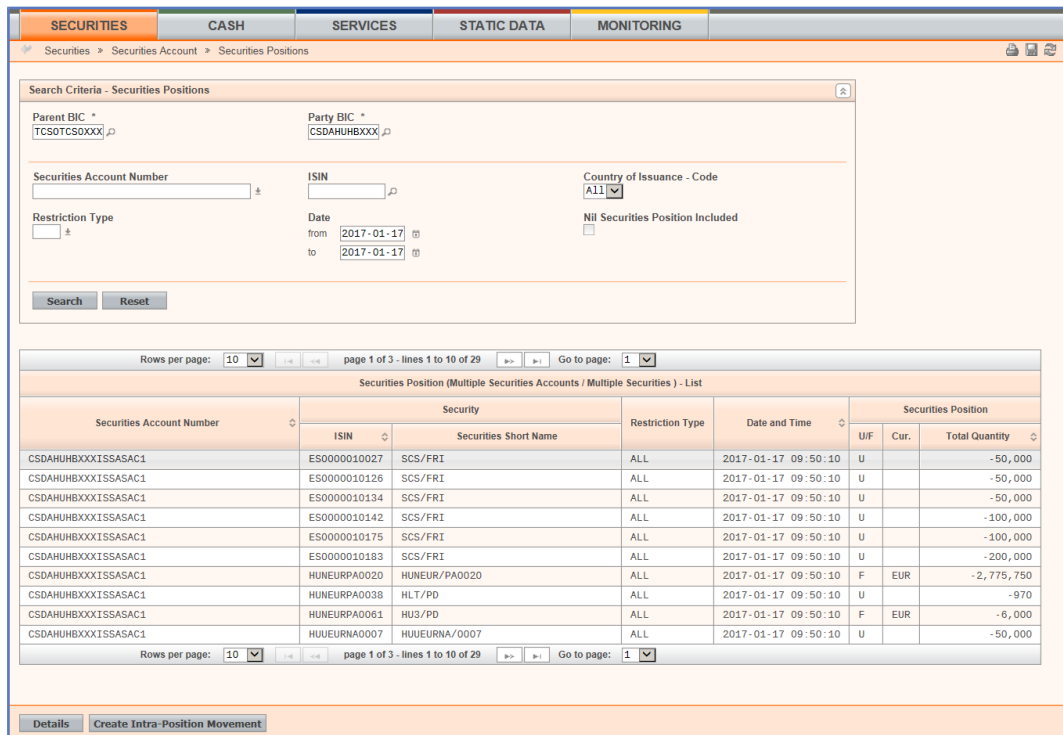

Illustration 54: Securities positions – search/list screen

Field Description

Securities Positions – Search Criteria	
Party BIC*	<p>Select the BIC of the party owning the securities positions you want to retrieve from the drop-down menu or search via the <i>magnifier</i> icon.</p> <p>At least Party BIC or ISIN must be provided as search criteria. When opening the screen, this field will be defaulted to the Party BIC of the user’s party.</p> <p>References for error messages: [▶ 1381]</p> <ul style="list-style-type: none"> <input type="checkbox"/> QMPC032 <input type="checkbox"/> QMPC065
Parent BIC*	<p>Select the BIC of the CSD where the above party holds the securities positions you want to retrieve from the drop-down menu.</p>

Securities Positions – Search Criteria	
	<p>When opening the screen, this field will be defaulted to the Parent BIC of the user's party.</p> <p>References for error messages: [▶ 1381]</p> <ul style="list-style-type: none"><input type="checkbox"/> QMPC048<input type="checkbox"/> QMPC065
Securities Account Number	<p>Select the number of the securities account from the drop-down menu.</p> <p>If there is only 1 possible securities account, this field is read-only.</p> <p>References for error messages: [▶ 1381]</p> <ul style="list-style-type: none"><input type="checkbox"/> QMPC030<input type="checkbox"/> QMPC065
ISIN	<p>Enter the ISIN of the security.</p> <p>Required format is: 12 characters (SWIFT-x), input-sensitive</p> <p>The ISIN must exist in T2S.</p> <p>At least Party BIC or ISIN must be provided as search criteria.</p> <p>Reference for error message: [▶ 1381]</p> <ul style="list-style-type: none"><input type="checkbox"/> QMPC018
Country of Issuance - Code	<p>Select the country where the securities are issued from the drop-down menu.</p>
Restriction Type	<p>Select the restriction type if you want to view only the securities positions for one restriction type from the drop-down menu.</p> <p>If you select the value 'All', the sum of all securities positions is displayed in the list.</p> <p>Reference for error message: [▶ 1381]</p> <ul style="list-style-type: none"><input type="checkbox"/> QMPC091
Date from	<p>Enter the date from which you want to view the securities positions or use the <i>calendar</i> icon. The default value is the current business day.</p> <p>Required format is: YYYY-MM-DD</p>

Securities Positions – Search Criteria	
	<p>The Date from date must be a valid business date earlier than or equal to the current business date and earlier than or equal to the Date to date.</p> <p>References for error messages: [▶ 1381]</p> <ul style="list-style-type: none"> <input type="checkbox"/> QMPC015 <input type="checkbox"/> QMPC016
Date to	<p>Enter the date until which you want to view the securities positions or use the <i>calendar</i> icon. The default value is the date entered in the 'Date from' field.</p> <p>Required format is: YYYY-MM-DD</p> <p>The Date to date must be a valid business date earlier than or equal to the current business date.</p> <p>Reference for error message: [▶ 1381]</p> <ul style="list-style-type: none"> <input type="checkbox"/> QMPC015
Nil Securities Position included	<p>Select whether securities position(s) equal to 0 are included. The default value is 'No (not checked)'.</p>
Multiple Securities Positions (Multiple Securities Accounts / Multiple Securities)	
Securities Account Number	<p>Shows the number of the securities account of the securities position.</p> <p>References for error messages: [▶ 1381]</p> <ul style="list-style-type: none"> <input type="checkbox"/> QMPC030 <input type="checkbox"/> QMPC065
ISIN	<p>Show the ISIN of the security.</p> <p>Reference for error message: [▶ 1381]</p> <ul style="list-style-type: none"> <input type="checkbox"/> QMPC018
Securities Short Name	<p>Shows the short name of the security.</p>
Restriction Type	<p>Shows the restriction type of the securities position.</p> <p>Reference for error message: [▶ 1381]</p> <ul style="list-style-type: none"> <input type="checkbox"/> QMPC091
Date and Time	<p>Shows the date and time of the last movement of the securities position when positions are retrieved for the current business date and the date of the position when positions are retrieved for a period.</p>

Securities Positions – Search Criteria	
	Displayed format is: YYYY-MM-DD hh:mm:ss:µsµsµsµsµs
Settlement Type	Shows the quantity type related to the securities from the possible values: <input type="checkbox"/> U (for unit) <input type="checkbox"/> F (for face amount)
Currency	Shows the currency in which the securities were issued. This field is only filled if the quantity of the securities position is given as a face amount.
Total Quantity	Shows the total quantity of the securities position per securities account and ISIN. If the Date to is different from the Date from, the different end of day values of the position for each date of the selected period are shown. Provision of '99999...99' in case oversizing occurs in the integer portion. Truncation of decimals in case oversizing occurs in the decimal portion.

Buttons

Buttons	
Search	This function enables you to start a search according to the criteria entered. The results are displayed in a list on the same screen. If the search retrieves a single record, the <i>details</i> screen is displayed directly. Next screens: <input type="checkbox"/> <i>Securities positions - search/list</i> screen <input type="checkbox"/> <i>Securities position - details</i> screen [▶ 174] References for error messages: [▶ 1381] <input type="checkbox"/> QMPC015 <input type="checkbox"/> QMPC016 <input type="checkbox"/> QMPC018 <input type="checkbox"/> QMPC030 <input type="checkbox"/> QMPC032 <input type="checkbox"/> QMPC048 <input type="checkbox"/> QMPC065 <input type="checkbox"/> QMPC091

Reset	This function enables you to set default search criteria and blanks out all optional criteria. Next screen: <input type="checkbox"/> <i>Securities positions - search/list</i> screen
Details	This function enables you to display the details of the selected securities position. Next screen: <input type="checkbox"/> <i>Securities position – details</i> screen [▶ 174]
Create Intra-position movement	This function enables you to create a new restricted securities position for the selected securities account number and ISIN. Next screen: <input type="checkbox"/> <i>Intra-position movement - new</i> screen [▶ 151]

2.2.2.16 Securities Position - Details Screen

Context of Usage

This screen displays detailed information on the securities positions for a T2S securities account owner, i.e. a party which is a CSD, a CB (as CSD participant) or a settlement bank. You can check the data and proceed further by clicking on the buttons below.

During the Start of Day, when the CRDM data is being replicated in the Settlement domain, only the securities positions data available at the End-of-Day of the previous business day is displayed at the screen. The securities positions data for the new business day is available as of the end of the CRDM data replication.

During night-time, the securities positions can only be displayed in-between night-time settlement sequences.{CR-634}

Screen Access

- Securities >> Securities Account >> Securities Positions >> *Securities positions – search/list* screen >> Click on the *search* and/or *details* button
- Securities >> Settlement >> Securities Positions >> *Securities positions – search/list* screen >> Click on the *search* and/or *details* button
- Monitoring >> Monitoring >> Securities Positions >> *Securities positions – search/list* screen >> Click on the *search* and/or *details* button

- Securities >> Settlement >> Intra-position Movements >> *Intra-position movements with current and historical status – search screen* >> Click on the *search* button >> *Intra-position movements – list screen* >> Click on the *details* button >> *Intra-position movement – details screen* >> Click on the *securities position details* button

Privileges No privilege needed to use this screen.

References **User Instructions Part**

This screen is part of the following business scenarios:

- View current securities positions and related postings [▶ 722]
- View current securities positions and related restrictions [▶ 723]
- View historic securities positions for a specific period [▶ 725]
- View historic securities positions for a specific date [▶ 724]

Business Functionality Document

This screen corresponds to the following business function:

- Display securities account positions (T2S.GUI.SESE.POS.0020)

Screenshot

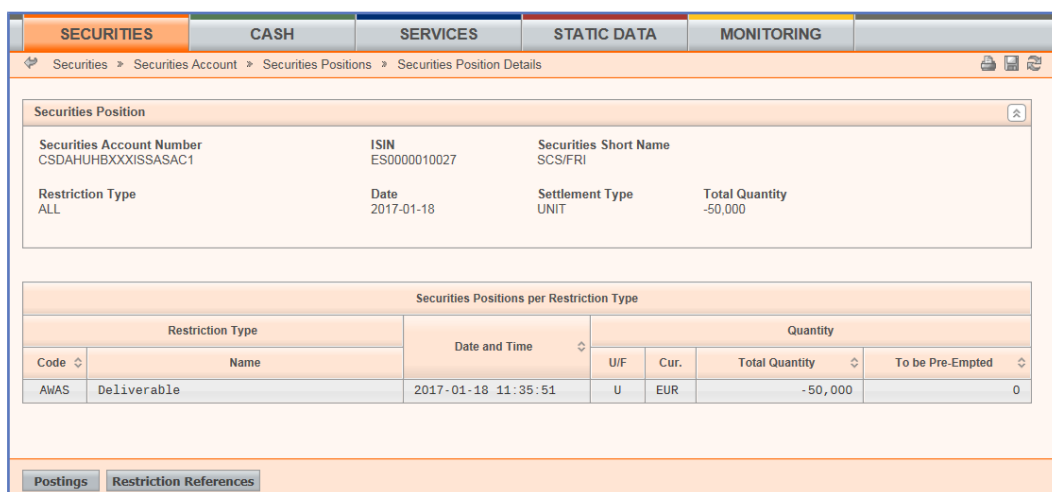

Illustration 55: Securities position – details screen

Field Description

Identification of Securities Positions	
Securities Account Number	Shows the number of the securities account of the securities position.
ISIN	Shows the ISIN of the security.
Securities Short Name	Shows the short name of the security.
Restriction Type	Shows the restriction type of the securities position.
Date	Shows the date for which you requested the securities position. Displayed format is: YYYY-MM-DD

Identification of Securities Positions	
Settlement Type	Shows the quantity type related to the securities from the possible values: <input type="checkbox"/> U (for unit) <input type="checkbox"/> F (for face amount)
Currency	Shows the currency in which the securities were issued. This field is only filled if the quantity of the security is given as a face amount.
Total Quantity	Shows the total quantity of the securities position per securities account and ISIN. Provision of '99999...99' in case oversizing occurs in the integer portion. Truncation of decimals in case oversizing occurs in the decimal portion.
Securities Positions per Restriction Type	
Restriction Type	
Code	Shows the code of the restriction type of the securities position.
Name	Shows the name of the restriction type of the securities position. Only the first 35 characters of the restriction type description are displayed here.
Date and Time	Shows the date and time of the last movement related to the securities position. Displayed format is: YYYY-MM-DD hh:mm:ss:µsµsµsµsµs
Quantity	
Settlement Type	Shows the quantity type related to the securities from the possible values: <input type="checkbox"/> U (for Unit) <input type="checkbox"/> F (for Face amount)
Currency	Shows the currency in which the securities were issued. This field is only filled if the quantity of the securities position is given as a face amount.
Total Quantity	Shows the total quantity of the securities position per restriction type.

Identification of Securities Positions	
	Provision of '99999...99' in case oversizing occurs in the integer portion. Truncation of decimals in case oversizing occurs in the decimal portion.
To Be Pre-Empted	Shows the quantity of the securities position that is to be pre-empted. Provision of '99999...99' in case oversizing occurs in the integer portion. Truncation of decimals in case oversizing occurs in the decimal portion.

Buttons

Buttons	
Postings	This function displays the securities postings for the selected securities position. Next screen: <input type="checkbox"/> Securities postings - search/list screen [82]
Restrictions References	This function displays the details per restriction reference for the selected securities position. Next screen: <input type="checkbox"/> Securities restriction detail - search/list screen [86]

2.2.2.17 Settlement Instructions - Search/List Screen

Context of Usage

This screen contains a number of search fields. By inputting the relevant data, you can search for settlement instructions. The search results will be displayed in a list.

After selecting an entry, you can proceed further by clicking on the buttons below.

This screen is not relevant for CB users.

Screen Access

[Securities >> Settlement >> Settlement Instructions](#)

Privileges

To use this screen, you need the following privileges [[1233](#)]:

Settlement instruction query

References**User Instructions Part**

This screen is part of the following business scenarios:

- [Add a link for a settlement instruction \[744\]](#)
- [Amend the partial settlement indicator for a settlement instruction \[747\]](#)
- [Amend the priority for a settlement instruction \[748\]](#)
- [Cancel a settlement instruction \[768\]](#)

- Copy a settlement instruction [[▶ 731](#)]
- Enter a settlement instruction [[▶ 727](#)]
- Put a settlement instruction on CSD hold [[▶ 756](#)]
- Put a settlement instruction on party hold [[▶ 754](#)]
- Release a settlement instruction from CoSD hold [[▶ 763](#)]
- Release a settlement instruction from CSD hold [[▶ 761](#)]
- Release a settlement instruction from CSD validation hold [[▶ 765](#)]
- Release a settlement instruction from party hold [[▶ 758](#)]
- Partially release a settlement instruction from party hold [[▶ 759](#)]
- Remove a link for a settlement instruction [[▶ 750](#)]
- View Alleged Cancellation Instructions [[▶ 771](#)]
- View settlement instruction details [[▶ 742](#)]

Business Functionality Document

This screen corresponds to the following business functions:

- Query instruction (T2S.GUI.SESE.INX.0010)
- Display instruction list (T2S.GUI.SESE.INX.0020)

Screenshot

The screenshot displays the 'Settlement Instructions - Search/List' screen. It features a navigation bar with tabs for SECURITIES, CASH, SERVICES, and MONITORING. The main content area is titled 'Search Criteria - Settlement Instructions' and is organized into several sections:

- General Criteria:** Includes fields for Actor Reference, T2S Reference, Account Owner Reference, Account Servicer Reference, Third Party Reference, T2S Matching Reference, Instructing Party Parent BIC, Instructing Party BIC, ISIN, Securities Account, Account Owner, Dedicated Cash Account, Pool Reference, Common Reference, and Corporate Action Event.
- Multiple Value Criteria:** Includes Securities Movement Type Code, Payment Type Code, Securities Transaction Type, CumEx Indicator, Settlement Transaction Condition Indicator, Credit Debit Code, Settlement Currency, and Country of Issuance - Code.
- Other Criteria:** Includes Priority, Issuer CSD, Delivering CSD BIC, Receiving CSD BIC, Delivering CSD Participant, Receiving CSD Participant, Delivering CSD Participant Processing Reference, Receiving CSD Participant Processing Reference, Delivering CSD Client of the Participant BIC, Partial Settlement Indicator, and CoSD Flag.
- Range Criteria:** Includes Trade Date, Intended Settlement Date, Actual Settlement Date, Quantity or nominal of securities, Settlement Type, and Settlement Cash Amount.
- Status Criteria:** Includes ISO Settlement Status, Settlement Status, Matching Status, Cancellation Status, CSD Hold Status, Party Hold Status, CSD Validation Hold Status, CoSD Hold Status, and Approval Status.

At the bottom, there is a table with columns: Actor Reference, Instructing Party BIC, Instructing Party Parent BIC, Securities Account Number, and ISIN. The table shows two rows of data. Below the table are 'Search' and 'Reset' buttons, and a pagination control showing 'page 1 of 1 - lines 1 to 2 of 2'.

Illustration 56: Settlement instructions - search/list screen

Field Description

Settlement Instructions – Search Criteria	
General Criteria	
Actor Reference	Enter the identification assigned by the T2S actor. The settlement instruction can be identified by the T2S reference or the combination of the actor reference and the instructing party BIC.

Settlement Instructions – Search Criteria	
	Required format is: max. 16 characters (SWIFT-x)
T2S Reference	Enter the instruction identification code assigned by T2S. Required format is: max. 16 characters (SWIFT-x)
Securities Account Owner Reference	Enter the reference assigned by the T2S delivering/receiving party to the instruction. Required format is: max. 16 characters (SWIFT-x)
Securities Account Servicer Reference	Enter the reference of an instruction as assigned by the CSD. Required format is: max. 16 characters (SWIFT-x)
Third Party Reference	Enter the reference of an instruction as assigned by the third party. Required format is: max. 16 characters (SWIFT-x)
T2S Matching Reference	Enter the common reference assigned by T2S to all the settlement instructions comprising a transaction. Required format is: max. 16 characters (SWIFT-x)
Instructing Party BIC	You can choose to either enter the 'Instructing Party BIC' or to select it from the suggested items in the drop-down menu. Required format is: max. 11 characters (SWIFT-x) Reference for error message [▶ 1444]: <input type="checkbox"/> QMPC032
Instructing Party Parent BIC	You can choose to either enter the 'Instructing Party Parent BIC' or to select it from the suggested items in the drop-down menu. Required format is: max. 11 characters (SWIFT-x) Reference for error message [▶ 1444]: <input type="checkbox"/> QMPC048
ISIN	Select the ISIN of the settlement instruction from the drop-down menu. Required format is: 12 characters (SWIFT-x) Reference for error message [▶ 1444]: <input type="checkbox"/> QMPC018
Securities Account Number	You can choose to either enter the 'Securities Account Number' or to select it from the suggested items in the drop-down menu.

Settlement Instructions – Search Criteria	
	<p>In order to query external CSD settlement instructions the selection criterion 'Securities Account Number' must not be filled in.</p> <p>Required format is: max. 35 characters (SWIFT-x)</p> <p>Reference for error message [▶ 1444]:</p> <ul style="list-style-type: none"> <input type="checkbox"/> QMPC030
Securities Account Owner BIC	<p>You can choose to either enter the 'Securities Account Owner BIC' or to select it from the suggested items in the drop-down menu.</p> <p>Required format is: max. 11 characters (SWIFT-x)</p>
T2S Dedicated Cash Account Number	<p>You can choose to either enter the 'T2S Dedicated Cash Account Number' or to select it from the suggested items in the drop-down menu.</p> <p>Required format is: max. 34 characters (SWIFT-x)</p> <p>Reference for error message [▶ 1444]:</p> <ul style="list-style-type: none"> <input type="checkbox"/> QMPC031
Pool Reference	<p>Enter the reference of the pool of the settlement instruction.</p> <p>Required format is: max. 35 characters (SWIFT-x)</p>
Common Reference	<p>Enter the common reference of the settlement instruction.</p> <p>Required format is: max. 35 characters (SWIFT-x)</p>
Corporate Action Event	<p>Enter the reference of the corporate action event.</p> <p>Required format is: max. 35 characters (SWIFT-x)</p>
Multiple Value Criteria	
Securities Movement Type	<p>Select the securities movement type code from the possible values:</p> <ul style="list-style-type: none"> <input type="checkbox"/> All (default value) <input type="checkbox"/> Delivery <input type="checkbox"/> Receive
Payment Type Code	<p>Select the payment type code from the possible values:</p> <ul style="list-style-type: none"> <input type="checkbox"/> All (default value) <input type="checkbox"/> Against payment settlement <input type="checkbox"/> Free of payment

Settlement Instructions – Search Criteria	
Securities Transaction Type	<p>Enter or select the securities transaction type expressed as an ISO 20022 code from the possible values:</p> <ul style="list-style-type: none"><input type="checkbox"/> All (default value)<input type="checkbox"/> AUTO (for auto-collateralisation)<input type="checkbox"/> BYIY (for buy-in)<input type="checkbox"/> BSBK (for buy sell back)<input type="checkbox"/> CLAI (for market claim)<input type="checkbox"/> CNCB (for central bank collateral operation)<input type="checkbox"/> COLI (for collateral in)<input type="checkbox"/> COLO (for collateral out)<input type="checkbox"/> CONV (for depository receipt conversion)<input type="checkbox"/> CORP (for corporate action)<input type="checkbox"/> ETFT (for exchange traded funds)<input type="checkbox"/> FCTA (for factor update)<input type="checkbox"/> INSP (for move of stock)<input type="checkbox"/> ISSU (for depository receipt issue)<input type="checkbox"/> MKDW (for mark down)<input type="checkbox"/> MKUP (for mark up)<input type="checkbox"/> NETT (for netting)<input type="checkbox"/> NSYN (for non syndicated)<input type="checkbox"/> OWNE (for external account transfer)<input type="checkbox"/> OWNI (for internal account transfer)<input type="checkbox"/> PAIR (for pair off)<input type="checkbox"/> PLAC (for placement)<input type="checkbox"/> PORT (for portfolio move)<input type="checkbox"/> REAL (for realignment)<input type="checkbox"/> REDI (for withdrawal)<input type="checkbox"/> REDM (for redemption)<input type="checkbox"/> RELE (for depository receipt release cancellation)<input type="checkbox"/> REPU (for repo)<input type="checkbox"/> RODE (for return delivery without matching)<input type="checkbox"/> RVPO (for reverse repurchase agreement)

Settlement Instructions – Search Criteria	
	<input type="checkbox"/> SBBK (for sell buy back) <input type="checkbox"/> SBRE (for borrowing reallocation) <input type="checkbox"/> SECB (for securities borrowing) <input type="checkbox"/> SECL (for securities lending) <input type="checkbox"/> SLRE (for lending reallocation) <input type="checkbox"/> SUBS (for subscription) <input type="checkbox"/> SWIF (for switch from) <input type="checkbox"/> SWIT (for switch to) <input type="checkbox"/> SYND (for syndicate underwriters) <input type="checkbox"/> TBAC (for TBA closing) <input type="checkbox"/> TRAD (for trade) <input type="checkbox"/> TRPO (for triparty repo) <input type="checkbox"/> TRVO (for triparty reverse repo) <input type="checkbox"/> TURN (for turnaround)
Cum/Ex Indicator	Select the cum/ex indicator from the possible values: <input type="checkbox"/> All (default value) <input type="checkbox"/> Cum <input type="checkbox"/> Ex
Opt/Out ISO Settlement Transaction Condition Indicator	Select the opt/out settlement transaction condition indicator from the possible values: <input type="checkbox"/> All (default value) <input type="checkbox"/> No <input type="checkbox"/> Yes
Debit Credit Indicator	Select the credit/debit code from the possible values: <input type="checkbox"/> All (default value) <input type="checkbox"/> Credit <input type="checkbox"/> Debit
Settlement Currency	Select the eligible currency for settlement in T2S from the drop-down menu. The default value is 'all'. Reference for error message [▶ 1444]: <input type="checkbox"/> QMPC054

Settlement Instructions – Search Criteria	
Country of Issuance - Code	Select the country where the security was issued from the drop-down menu.
Other Criteria	
Priority	Select the priority from the possible values: <ul style="list-style-type: none"> <input type="checkbox"/> All (default value) <input type="checkbox"/> Normal <input type="checkbox"/> High <input type="checkbox"/> Top <input type="checkbox"/> Reserved
Issuer CSD	You can choose to either enter the BIC of the 'Issuer CSD' or to select it from the suggested items in the drop-down menu. Required format is: max. 11 characters (SWIFT-x)
Delivering CSD BIC	You can choose to either enter the 'Delivering CSD BIC' or to select it from the suggested items in the drop-down menu. Required format is: max. 11 characters (SWIFT-x)
Receiving CSD BIC	You can choose to either enter the 'Receiving CSD BIC' or to select it from the suggested items in the drop-down menu. Required format is: max. 11 characters (SWIFT-x)
Delivering CSD Participant	You can choose to either enter the BIC of the 'Delivering CSD Participant' or to select it from the suggested items in the drop-down menu. Required format is: max. 11 characters (SWIFT-x)
Receiving CSD Participant	You can choose to either enter the BIC of the 'Receiving CSD Participant' or to select it from the suggested items in the drop-down menu. Required format is: max. 11 characters (SWIFT-x)
Delivering CSD Participant Processing Reference	Enter the delivering CSD participant processing reference. Required format is: max. 34 characters (SWIFT-x)
Receiving CSD Participant Processing Reference	Enter the receiving CSD participant processing reference. Required format is: max. 34 characters (SWIFT-x)

Settlement Instructions – Search Criteria	
Delivering CSD Client of the Participant BIC	Enter the 'Delivering CSD Client of the Participant BIC'. Required format is: max. 11 characters (SWIFT-x)
Receiving CSD Client of the Participant BIC	Enter the 'Receiving CSD Client of the Participant BIC'. Required format is: max. 11 characters (SWIFT-x)
Partial Settlement Indicator	Select the partial settlement indicator from the possible values: <input type="checkbox"/> All (default value) <input type="checkbox"/> Yes <input type="checkbox"/> No
CoSD Flag	Select the CoSD Flag from the possible values: <input type="checkbox"/> All (default value) <input type="checkbox"/> Yes <input type="checkbox"/> No
Range Criteria	
Trade Date from	Enter the lower bound of the search range for the date from which the trade date is valid or use the <i>calendar</i> icon. Required format is: YYYY-MM-DD References for error messages [▶ 1444]: <input type="checkbox"/> QMPC007 <input type="checkbox"/> QMPC010 <input type="checkbox"/> QMPC011
Trade Date to	Enter the upper bound of the search range for the date until which the trade date is valid or use the <i>calendar</i> icon. Required format is: YYYY-MM-DD Reference for error message [▶ 1444]: <input type="checkbox"/> QMPC007
Intended Settlement Date from	Enter the lower bound of the search range for the date from which the intended settlement date is valid or use the <i>calendar</i> icon. Required format is: YYYY-MM-DD References for error messages [▶ 1444]: <input type="checkbox"/> QMPC010

Settlement Instructions – Search Criteria	
	<input type="checkbox"/> QMPC012
Intended Settlement Date to	<p>Enter the upper bound of the search range for the date until which the intended settlement date is valid or use the <i>calendar</i> icon.</p> <p>Required format is: YYYY-MM-DD</p> <p>Reference for error message [▶ 1444]:</p> <input type="checkbox"/> QMPC012
Actual Settlement Date and Time from	<p>Enter the lower bound of the search range for the date and time from which the actual settlement date is valid or use the <i>calendar</i> icon.</p> <p>Required format is: YYYY-MM-DD hh:mm:ss</p> <p>References for error messages [▶ 1444]:</p> <input type="checkbox"/> QMPC011 <input type="checkbox"/> QMPC013 <input type="checkbox"/> QMPC014
Actual Settlement Date and Time to	<p>Enter the upper bound of the search range for the date and time until which the actual settlement date is valid or use the <i>calendar</i> icon.</p> <p>Required format is: YYYY-MM-DD hh:mm:ss</p> <p>Reference for error message [▶ 1444]:</p> <input type="checkbox"/> QMPC014
Quantity/Nominal from	<p>Enter the lower bound of the search range for the quantity of securities.</p> <p>Required format is: Decimal Number</p> <p>Reference for error message [▶ 1444]:</p> <input type="checkbox"/> QMPC006
Quantity/Nominal to	<p>Enter the upper bound of the search range for the quantity of securities.</p> <p>Required format is: Decimal Number</p> <p>Reference for error message [▶ 1444]:</p> <input type="checkbox"/> QMPC006
Settlement Type	<p>Select the settlement type from the possible values:</p> <input type="checkbox"/> All (default value) <input type="checkbox"/> Units

Settlement Instructions – Search Criteria	
	<input type="checkbox"/> Nominal
Settlement Cash Amount More than	<p>Enter the lower bound of the search range for the settlement cash amount.</p> <p>Required format is: max. 19 digit(s) incl. decimal point (thereof max. 5 decimal places)</p> <p>Reference for error message [▶ 1444]:</p> <input type="checkbox"/> QMPC005
Settlement Cash Amount Equal/less	<p>Enter the upper bound of the search range for the settlement cash amount.</p> <p>Required format is: max. 19 digit(s) incl. decimal point (thereof max. 5 decimal places)</p> <p>Reference for error message [▶ 1444]:</p> <input type="checkbox"/> QMPC005
Status Criteria	
ISO Settlement status	<p>Select the settlement status of the settlement instruction from the possible values:</p> <input type="checkbox"/> All (default value) <input type="checkbox"/> Pending <input type="checkbox"/> Failing <p>If value 'Settlement Status' field is set to 'Settled' or 'Cancellation Status' field is set to 'Cancelled', this field is disabled.</p> <p>No date search range is allowed for the ISO Settlement Status.</p>
Settlement Status	<p>Select the settlement status from the possible values:</p> <input type="checkbox"/> All (default value) <input type="checkbox"/> Unsettled <input type="checkbox"/> Settled <input type="checkbox"/> Partially settled
Date and Time from	<p>Enter the lower bound of the search range for the date and time from which the settlement status is valid or use the <i>calendar</i> icon.</p> <p>Required format is: YYYY-MM-DD hh:mm:ss</p>

Settlement Instructions – Search Criteria	
Date and Time to	Enter the upper bound of the search range for the date and time until which the settlement status is valid or use the <i>calendar</i> icon. Required format is: YYYY-MM-DD hh:mm:ss
Matching Status	Select the match status from the possible values: <input type="checkbox"/> Unmatched <input type="checkbox"/> Matched <input type="checkbox"/> All (default value)
Date and Time from	Enter the lower bound of the search range for the date and time from which the match status is valid or use the <i>calendar</i> icon. Required format is: YYYY-MM-DD hh:mm:ss
Date and Time to	Enter the upper bound of the search range for the date and time to which the match status is valid or use the <i>calendar</i> icon. Required format is: YYYY-MM-DD hh:mm:ss
Cancellation Status	Select the cancellation status from the possible values: <input type="checkbox"/> All (default value) <input type="checkbox"/> Not cancelled <input type="checkbox"/> Cancelled
Date and Time from	Enter the lower bound of the search range for the date and time from which the cancellation status is valid or use the <i>calendar</i> icon. Required format is: YYYY-MM-DD hh:mm:ss
Date and Time to	Enter the upper bound of the search range for the date and time until which the cancellation status is valid or use the <i>calendar</i> icon. Required format is: YYYY-MM-DD hh:mm:ss
CSD Hold Status	Select the CSD hold status from the possible values: <input type="checkbox"/> All (default value) <input type="checkbox"/> No <input type="checkbox"/> Yes
Date and Time from	Enter the lower bound of the search range for the date and time from which the CSD hold status is valid or use the <i>calendar</i> icon.

Settlement Instructions – Search Criteria	
	Required format is: YYYY-MM-DD hh:mm:ss
Date and Time to	Enter the upper bound of the search range for the date and time until which the CSD hold status is valid or use the <i>calendar</i> icon. Required format is: YYYY-MM-DD hh:mm:ss
Party Hold Status	Select the party hold status from the possible values: <input type="checkbox"/> All (default value) <input type="checkbox"/> No <input type="checkbox"/> Yes
Date and Time from	Enter the lower bound of the search range for the date and time from which the party hold status is valid or use the <i>calendar</i> icon. Required format is: YYYY-MM-DD hh:mm:ss
Date and Time to	Enter the upper bound of the search range for the date and time until which the party hold status is valid or use the <i>calendar</i> icon. Required format is: YYYY-MM-DD hh:mm:ss
CSD Validation Hold Status	Select the party hold status from the possible values: <input type="checkbox"/> All (default value) <input type="checkbox"/> No <input type="checkbox"/> Yes
Date and Time from	Enter the lower bound of the search range for the date and time from which the CSD validation hold status is valid or use the <i>calendar</i> icon. Required format is: YYYY-MM-DD hh:mm:ss
Date and Time to	Enter the upper bound of the search range for the date and time until which the CSD validation hold status is valid or use the <i>calendar</i> icon. Required format is: YYYY-MM-DD hh:mm:ss
CoSD Hold Status	Select the CoSD hold status from the possible values: <input type="checkbox"/> All (default value) <input type="checkbox"/> No <input type="checkbox"/> Yes

Settlement Instructions – Search Criteria	
Date and Time from	Enter the lower bound of the search range for the date and time from which the CoSD hold status is valid or use the <i>calendar</i> icon. Required format is: YYYY-MM-DD hh:mm:ss
Date and Time to	Enter the upper bound of the search range for the date and time until which the CoSD hold status is valid or use the <i>calendar</i> icon. Required format is: YYYY-MM-DD hh:mm:ss
Approval Status	Select the approval status from the possible values: <input type="checkbox"/> All (default value) <input type="checkbox"/> Approved <input type="checkbox"/> Awaiting Approval <input type="checkbox"/> Rejected <input type="checkbox"/> Revoked
Date and Time from	Enter the lower bound of the search range for the date and time from which the approval status is valid or use the <i>calendar</i> icon. Required format is: YYYY-MM-DD hh:mm:ss
Date and Time to	Enter the upper bound of the search range for the date and time until which the approval status is valid or use the <i>calendar</i> icon. Required format is: YYYY-MM-DD hh:mm:ss
Settlement Instructions – List	
Actor Reference	Shows the identification of the referenced instruction assigned by the T2S actor.
Instructing Party BIC	Shows the BIC of the instructing party.
Instructing Party Parent BIC	Shows the parent BIC of the instructing party.
Securities Account Number	Shows the securities account of the referenced instruction.
ISIN	Shows the ISIN of the settlement instruction.
Securities Description	Shows the description of the selected ISIN.
Securities Movement Type Code	Shows the securities movement type code from the possible values:

Settlement Instructions – Search Criteria	
	<input type="checkbox"/> Delivery <input type="checkbox"/> Receive
Quantity/Nominal	<p>Shows quantity of financial instrument in units, original face amount or current face amount.</p> <p>The Unit or Face amount corresponds to the original settlement quantity.</p>
Settlement Amount	Shows the amount stated in the LCMM Instruction.
Settlement Status	<p>Shows the settlement status of the instruction from the possible values:</p> <input type="checkbox"/> Unsettled <input type="checkbox"/> Settled <input type="checkbox"/> Partially settled
Matching Status	<p>Shows the match status of the instruction from the possible values:</p> <input type="checkbox"/> Unmatched <input type="checkbox"/> Matched
Cancellation Status	<p>Shows the cancellation status of the instruction from the possible values:</p> <input type="checkbox"/> Not cancelled <input type="checkbox"/> Cancelled

Buttons

Buttons	
Search	<p>This function enables you to start a search according to the criteria entered. The results are displayed in a list on the next screen.</p> <p>If the search retrieves a single record, the <i>details</i> screen is displayed directly.</p> <p>Next screens:</p> <ul style="list-style-type: none"> <input type="checkbox"/> <i>Settlement instructions – search/list</i> screen <input type="checkbox"/> <i>Settlement instruction – details</i> screen [▶ 192] <p>References for error messages [▶ 1444]:</p> <ul style="list-style-type: none"> <input type="checkbox"/> QMPC005 <input type="checkbox"/> QMPC006 <input type="checkbox"/> QMPC007 <input type="checkbox"/> QMPC010

	<input type="checkbox"/> QMPC011 <input type="checkbox"/> QMPC012 <input type="checkbox"/> QMPC013 <input type="checkbox"/> QMPC014 <input type="checkbox"/> QMPC018 <input type="checkbox"/> QMPC030 <input type="checkbox"/> QMPC031 <input type="checkbox"/> QMPC032 <input type="checkbox"/> QMPC048 <input type="checkbox"/> QMPC054
Reset	<p>This function enables you to set all fields to default value and blanks out all optional fields.</p> <p>Next screen:</p> <input type="checkbox"/> <i>Settlement instructions – search/list</i> screen [▶ 1444]
New	<p>This function enables you to create a new settlement instruction.</p> <p>Next screen:</p> <input type="checkbox"/> <i>Settlement instruction - new</i> screen [▶ 211]
Details	<p>This function enables you to display the details of the selected instruction.</p> <p>Next screen:</p> <input type="checkbox"/> <i>Settlement instruction – details</i> screen [▶ 192]

2.2.2.18 Settlement Instruction - Details Screen

Context of Usage

This screen displays detailed information on the selected settlement instruction. You can check the data and proceed further by clicking on the buttons below.

You can perform the following foreseen actions: check the specific details of a settlement instruction, amend it, cancel it, hold it or release it, see its revisions/ audit trail and status history or its related messages copy the shown instruction to create a new similar one as well as searching for the associated penalties of the settlement instruction or searching for the details of its matched settlement instruction.

This screen is not relevant for CB users.

Screen Access	<ul style="list-style-type: none">□ Securities >> Settlement >> Settlement Instructions >> <i>Settlement instructions – search/list</i> screen >> Click on the <i>search</i> button >> <i>Settlement instructions – search/list</i> screen >> Click on the <i>details</i> button□ Securities >> Settlement >> Settlement Instructions >> <i>Settlement instructions – search/list</i> screen >> Click on the <i>search</i> button >> <i>Settlement instructions Details</i> screen >> Click on the <i>Matched Instruction</i> button to access the <i>Details Screen</i> of the matched settlement instruction
Privileges	To use this screen, you need the following privilege: <ul style="list-style-type: none">□ Settlement instruction query
References	User Instructions Part <p>This screen is part of the following business scenarios:</p> <ul style="list-style-type: none">□ Add a link for a settlement instruction [▶ 744]□ Amend the partial settlement indicator for a settlement instruction [▶ 747]□ Amend the priority for a settlement instruction [▶ 748]□ Copy a settlement instruction [▶ 731]□ Cancel a settlement instruction [▶ 768]□ Put a settlement instruction on CSD hold [▶ 756]□ Put a settlement instruction on party hold [▶ 754]□ Release a settlement instruction from CoSD hold [▶ 763]□ Release a settlement instruction from CSD hold [▶ 761]□ Release a settlement instruction from CSD validation hold [▶ 765]□ Release a settlement instruction from party hold [▶ 758]□ Partially release a settlement instruction from party hold [▶ 759]□ Remove a link for a settlement instruction [▶ 750]□ View Alleged Cancellation Instructions [▶ 771]□ View settlement instruction details [▶ 742]□ View List of Penalties [▶ 783]□ View the Individual Penalty Details [▶ 776] Business Functionality Document <p>This screen corresponds to the following business function:</p> <ul style="list-style-type: none">□ Display instruction details (T2S.GUI.SESE.INX.0030).

Screenshot

SECURITIES	CASH	SERVICES	MONITORING
<p>Securities > Settlement > Settlement Instructions > Settlement Instruction Details</p>			
<p>Settlement Instruction</p>			
Securities Account Owner Reference ---	Securities Account Servicer Reference ---	Third Party Reference REST-S118	
T2S Reference 2304120667173831	T2S Matching Reference 012306689537000		
User Identification OPERATOR	Instructing Party BIC CDEISEXXX	Instructing Party Parent BIC CDEISEXXX	
Settlement Status Unsettled	Matching Status Matched	Partial Settlement Indicator ---	
ISO Settlement Status Falling			
Matched Settlement Amount ---	Matched Priority Normal	Matched Partial Settlement Indicator Partial Settlement Quantity Threshold allowed	
<p>Securities Movement Type Code Delivery</p>			
ISIN SIEURHOCE103	Securities Description F.A. EUR CSDE	Securities Account Number CDEISEXXXCSDMP001	
Securities Account Owner BIC CDEISEXXX	Original Settlement Quantity 20,000	Settlement Type Units	
	Settled Settlement Quantity ---		
Payment Type Code FREE	Debit Credit Indicator ---	Dedicated Cash Account Number ---	
Original Settlement Amount ---			
Settled Settlement Amount ---			
Entry Date and Time 2023-04-12 10:24:36.101	Intended Settlement Date 2023-04-12	Trade Date 2023-04-12	
Actual Settlement Date ---	Cancellation Date ---		
Accepted Timestamp 2023-04-12 10:24:37.904	Matched Timestamp 2023-04-12 10:24:38.222		
<p>Receiving Depository BIC CDEISEXXX</p>			
<p>Receiving CSD Participant</p>			
Party BIC PAREISEXX1	Processing Identification ---	Securities Account PAREISEXX1CSDPP001	
<p>Client of the Receiving CSD Participant</p>			
Party BIC ---	Name ---	Identification ---	
		Issuer ---	
		Schema Name ---	
<p>Delivering Depository BIC CDEISEXXX</p>			
<p>Delivering CSD Participant</p>			
Party BIC CDEISEXXX	Processing Identification ---	Securities Account CDEISEXXXCSDMP001	
<p>Client of the Delivering CSD Participant</p>			
Party BIC ---	Name ---	Identification ---	
		Issuer ---	
		Schema Name ---	
<p>Detailed Information</p>			
Priority NORMAL	Allowed Modification Flag Yes	CoSD Flag No	
Corporate Action Event Identification ---	Common Reference ---	Beneficial Ownership ---	
Repo Reference ---	Securities Transaction Type TRAD	Cum/Ex Indicator ---	
<p>Settlement Transaction Condition Indicator</p>			
<p>No records found.</p>			

Status Information

CSD Validation Hold Status Released	CSD Hold Status Released	CSD Hold Status Released
Party Hold Status Released	Cancellation Requested ---	

Reason Code Reference

Link - SPST003 - Settlement instruction is unsettled because a linked settlement instruction is 'on hold'

Link - SPST008 - Settlement instruction is unsettled because its counterpart settlement instruction is linked to a settlement instruction 'on hold'

Link - SPST021 - Settlement instruction is unsettled because another instruction stating a link WITH or BEFORE this instruction is 'on hold'

Link

Link Type	Reference Type	Reference	Reference Owner
USD	T2S reference	238412867173812	---
Pool Instruction Reference	Pool Instruction Counter	Pool Reference Owner BIC	---

Use of Restriction

Cash Sub Balance Type ---	Securities Sub Balance Type ---
------------------------------	------------------------------------

Restriction Reference

No records found.

Additional Receiving Parties

Receiving Party 3		
Party BIC	Name	Identification
---	---	---
		Issuer
		Schema Name

Receiving Party 4		
Party BIC	Name	Identification
---	---	---
		Issuer
		Schema Name

Receiving Party 5		
Party BIC	Name	Identification
---	---	---
		Issuer
		Schema Name

Additional Delivering Parties

Delivering Party 3		
Party BIC	Name	Identification
---	---	---
		Issuer
		Schema Name

Delivering Party 4		
Party BIC	Name	Identification
---	---	---
		Issuer
		Schema Name

Delivering Party 5		
Party BIC	Name	Identification
---	---	---
		Issuer
		Schema Name

Other Information

Deal Price		
Value Amount	Value Currency	---
---	---	---
Value Rate	Value Type	Yielded
---	---	---
Foreign Exchange		
Exchange Rate	Quoted Currency	---
---	---	---
Resulting Amount	Resulting Amount Currency	Unit Currency
---	---	---
Place of Trade		
Place of Trade Description	Place of Trade Market Identifier Code	Place of Trade Code
---	---	---
Proprietary Identification	Issuer Name	Schema Name
---	---	---
Other		
Number of Days Accrued	Original Ordered Amount	Original Ordered Currency
0	---	---
Market Client Side Code	Place of Clearing	---
---	---	---

Amendment Instr. | Hold/Release Instr. | Cancellation Instr. | Revisions | Status History | Related Outbound Messages | Related Inbound Messages | Copy | Recycle | Associated Penalties | Links | Matched Instruction

Illustration 57: Settlement instruction - details screen

Field

Description

Settlement Instruction	
<p>Securities Account Owner Reference</p>	<p>Shows the reference assigned by the account owner to the settlement instruction.</p> <p>Only one of the three references can be the T2S actor reference.</p>

Settlement Instruction	
Securities Account Servicer Reference	<p>Shows the reference assigned by the account servicer to the settlement instruction.</p> <p>Only one of the three references can be the T2S actor reference.</p>
Third Party Reference	<p>Shows the reference assigned by the third party to the settlement instruction.</p> <p>Only one of the three references can be the T2S actor reference.</p>
T2S Reference	<p>Shows the reference assigned by T2S to the settlement instruction.</p>
T2S Matching Reference	<p>Shows the common reference assigned by T2S to all the settlement instructions comprising a transaction.</p> <p>Only shown if the settlement instruction is matched.</p>
User Identification	<p>Shows the identification of the user who introduced the settlement instruction.</p>
Instructing Party BIC	<p>Shows the BIC of the instructing party of the settlement instruction.</p>
Instructing Party Parent BIC	<p>Shows the BIC of the instructing party parent of the settlement instruction.</p>
Matching Status	<p>Shows the match status of the settlement instruction from the possible values:</p> <ul style="list-style-type: none"><input type="checkbox"/> Unmatched<input type="checkbox"/> Matched
Settlement Status	<p>Shows the settlement status of the settlement instruction from the possible values:</p> <ul style="list-style-type: none"><input type="checkbox"/> Unsettled<input type="checkbox"/> Settled<input type="checkbox"/> Partially settled
ISO Settlement Status	<p>Shows the current ISO settlement status of the settlement instruction from the possible values:</p> <ul style="list-style-type: none"><input type="checkbox"/> Pending<input type="checkbox"/> Failing
Partial Settlement Indicator	<p>Shows the value of the partial settlement indicator of the settlement instruction from the possible values:</p> <ul style="list-style-type: none"><input type="checkbox"/> Partial not allowed

Settlement Instruction	
	<input type="checkbox"/> Partial settlement cash threshold allowed <input type="checkbox"/> Partial settlement quantity threshold allowed <input type="checkbox"/> Partial allowed
Matched Settlement Amount	Shows the matched effective amount on the transaction.
Matched Priority	Shows the priority of the transaction from the possible values: <input type="checkbox"/> Normal <input type="checkbox"/> High <input type="checkbox"/> Top <input type="checkbox"/> Reserved
Matched Partial Settlement Indicator	Shows the value of the partial settlement indicator of the transaction from the possible values: <input type="checkbox"/> Partial not allowed <input type="checkbox"/> Partial settlement cash threshold allowed <input type="checkbox"/> Partial settlement quantity threshold allowed
Securities Movement Type Code	Shows if the movement on a securities account results from a deliver or a receive instruction from the possible values: <input type="checkbox"/> Deliver <input type="checkbox"/> Receive
ISIN	Shows the ISIN code of the security.
Securities Description	Shows the description of the security.
Securities Account Number	Shows the account to or from which a securities entry is made.
Securities Account Owner BIC	Shows the BIC of the securities account owner.
Original Settlement Quantity	Shows the quantity stated in the settlement instruction.
Settlement Type	Shows the type of settlement foreseen for the security stated in the settlement instruction from the possible values: <input type="checkbox"/> Units

Settlement Instruction	
	<input type="checkbox"/> Face Amount
Settled Settlement Quantity	Shows the total quantity settled so far.
Payment Type Code	Shows if the transaction is to be settled with or without payment from the possible values: <input type="checkbox"/> Against payment settlement <input type="checkbox"/> Free of payment
Debit Credit Indicator	Shows if the original settlement amount is to be credited or debited from the possible values: <input type="checkbox"/> Credit <input type="checkbox"/> Debit
T2S Dedicated Cash Account Number	Shows the cash account stated in the settlement instruction.
Original Settlement Amount	Shows the settlement amount stated in the settlement instruction.
Currency	Shows the currency stated in the settlement instruction.
Settled Settlement Amount	Shows the total settlement amount settled so far.
Currency	Shows the currency stated in the settlement instruction.
Entry Date Time	Shows the date and timestamp when the settlement instruction has been created. Displayed format is: YYYY-MM-DD hh:mm:ss:µsµsµsµsµs
Intended Settlement Date	Shows the date at which the settlement instruction becomes eligible to be submitted to settlement. Displayed format is: YYYY-MM-DD
Trade Date	Shows the date at which the contract was made. Displayed format is: YYYY-MM-DD
Actual Settlement Date and Time	Shows the business date and the calendar time when the last settlement occurred. Displayed format is: YYYY-MM-DD hh:mm:ss:µsµsµsµsµs
Cancellation Date	Shows the business date when the settlement instruction has been cancelled. Displayed format is: YYYY-MM-DD
Accepted Timestamp (SF1)	Shows the accepted timestamp of the settlement instruction.

Settlement Instruction	
	Displayed format is: YYYY-MM-DD hh:mm:ss:µsµsµsµsµs
Matched Timestamp (SF2)	Shows the matched timestamp of the settlement instruction. In case the settlement instruction is unmatched no timestamp will be shown. Displayed format is: YYYY-MM-DD hh:mm:ss:µsµsµsµsµs
Receiving Depository BIC	Shows the BIC of the receiving depository.
Receiving CSD Participant BIC	Shows the BIC of the receiving CSD participant.
Processing Identification	Shows the reference of the instruction assigned by the receiving CSD participant.
Receiving CSD Participant Securities Account	Shows the Securities account of the receiving CSD participant.
Client of the Receiving CSD Participant BIC	Shows the BIC of the client of the receiving CSD participant.
Name	Shows the name and address of the client of the receiving CSD participant.
Identification	Shows the proprietary information, often a code, issued by the data source scheme issuer.
Issuer	Shows the entity that assigns the identification.
Schema Name	Shows the short textual description of the schema.
Delivering Depository BIC	Shows the BIC of the delivering depository.
Delivering CSD Participant BIC	Shows the BIC of the delivering CSD participant.
Processing Identification	Shows the reference of the instruction assigned by the delivering CSD participant.
Delivering CSD Participant Securities Account	Shows the securities account of the delivering CSD participant.
Client of the Delivering CSD Participant BIC	Shows the BIC of the client of the delivering CSD participant.

Settlement Instruction	
Name	Shows the name and address of the client of the delivering CSD participant.
Identification	Shows the proprietary information, often a code, issued by the data source scheme issuer.
Issuer	Shows the entity that assigns the identification.
Schema Name	Shows the short textual description of the schema.
Detailed Information	
Priority*	Shows the level of priority assigned to the settlement instruction from the possible values: <input type="checkbox"/> Normal <input type="checkbox"/> High <input type="checkbox"/> Top <input type="checkbox"/> Reserved
Allowed Modification Flag	Shows if a settlement instruction is non-modifiable by CSD participants from the possible values: <input type="checkbox"/> No <input type="checkbox"/> Yes
CoSD Flag	Shows if the Settlement Instruction has been identified as CoSD.
Corporate Action Event Identification	Shows the identification assigned by the account servicer to unambiguously identify a corporate action event.
Common Reference	Shows the reference provided by the T2S actor when the LCMM instruction is already matched or in order to facilitate the matching within T2S.
Beneficial Ownership	Shows if there is a change of beneficial ownership: <input type="checkbox"/> Empty (default value) <input type="checkbox"/> Yes <input type="checkbox"/> No
Repo Reference	Shows the identification of a collateral transaction as assigned by the instructing party.
Securities Transaction Type*	Shows the securities transaction type expressed as an ISO 20022 code from the possible values: <input type="checkbox"/> AUTO (for auto-collateralisation) <input type="checkbox"/> BYIY (for buy-in)

Settlement Instruction

- BSBK (for buy sell back)
- CLAI (for market claim)
- CNCB (for central bank collateral operation)
- COLI (for collateral in)
- COLO (for collateral out)
- CONV (for depository receipt conversion)
- CORP (for corporate action)
- ETFT (for exchange traded funds)
- FCTA (for factor update)
- INSP (for move of stock)
- ISSU (for depository receipt issue)
- MKDW (for mark down)
- MKUP (for mark up)
- NETT (for netting)
- NSYN (for non syndicated)
- OWNE (for external account transfer)
- OWNI (for internal account transfer)
- PAIR (for pair off)
- PLAC (for placement)
- PORT (for portfolio move)
- REAL (for realignment)
- REBL (for rebalancing)
- REDI (for withdrawal)
- REDM (for redemption)
- RELE (for depository receipt release cancellation)
- REPU (for repo)
- RODE (for return delivery without matching)
- RVPO (for reverse repurchase agreement)
- SBBK (for sell buy back)
- SBRE (for borrowing reallocation)
- SECB (for securities borrowing)
- SECL (for securities lending)

Settlement Instruction	
	<ul style="list-style-type: none"> <input type="checkbox"/> SLRE (for lending reallocation) <input type="checkbox"/> SUBS (for subscription) <input type="checkbox"/> SWIF (for switch from) <input type="checkbox"/> SWIT (for switch to) <input type="checkbox"/> SYND (for syndicate underwriters) <input type="checkbox"/> TBAC (for TBA closing) <input type="checkbox"/> TRAD (for trade) <input type="checkbox"/> TRPO (for triparty repo) <input type="checkbox"/> TRVO (for triparty reverse repo) <input type="checkbox"/> TURN (for turnaround)
Cum/EX Indicator	<p>Shows whether the contract was traded cum or ex coupon from the possible values:</p> <ul style="list-style-type: none"> <input type="checkbox"/> Empty <input type="checkbox"/> CUM <input type="checkbox"/> EX
Settlement Transaction Condition Indicator	<p>Shows the Settlement Transaction Condition Indicator from the possible values (This field can show multiple Settlement Transaction Condition Indicators):</p> <ul style="list-style-type: none"> <input type="checkbox"/> Empty (default value) <input type="checkbox"/> ADEA (accept after regular settlement deadline) <input type="checkbox"/> ASGN (assignment) <input type="checkbox"/> BUTC (buy to cover) <input type="checkbox"/> BSSP (buy in partially succesful) <input type="checkbox"/> CLEN (clean) <input type="checkbox"/> DIRT (dirty) <input type="checkbox"/> DLWM (delivery without matching) <input type="checkbox"/> DRAW (drawn) <input type="checkbox"/> EXER (exercised) <input type="checkbox"/> EXPI (expired) <input type="checkbox"/> FRCL (free clean settlement) <input type="checkbox"/> KNOC (knocked out) <input type="checkbox"/> NOMC (no automatic market claim) <input type="checkbox"/> PENS (pending sale)

Settlement Instruction	
	<input type="checkbox"/> PHYS (physical) <input type="checkbox"/> RESI (residual) <input type="checkbox"/> RHYP (rehypothecation) <input type="checkbox"/> RPTO (reporting) <input type="checkbox"/> SHOR (short sell) <input type="checkbox"/> SPDL (special delivery) <input type="checkbox"/> SPST (split settlement) <input type="checkbox"/> TRAN (transformation) <input type="checkbox"/> TRIP (triparty segregation) <input type="checkbox"/> UNEX (unexposed)
Status Information	
CSD Validation Hold Status	Shows the CSD validation hold status of the settlement instruction from the possible values: <input type="checkbox"/> No <input type="checkbox"/> Yes
CoSD Hold Status	Shows the CoSD hold status of the settlement instruction from the possible values: <input type="checkbox"/> No <input type="checkbox"/> Yes
CSD Hold Status	Shows the CSD hold status of the settlement instruction from the possible values: <input type="checkbox"/> No <input type="checkbox"/> Yes
Party Hold Status	Shows the party hold status of the settlement instruction from the possible values: <input type="checkbox"/> No <input type="checkbox"/> Yes
Cancellation Status	Shows the cancellation status of the settlement instruction from the possible values: <input type="checkbox"/> Not cancelled <input type="checkbox"/> Cancelled
Cancellation Re-quested	Shows if the settlement instruction has been requested for cancellation by its counterpart from the possible values:

Settlement Instruction	
	<input type="checkbox"/> Empty (default value) <input type="checkbox"/> Yes This situation occurs when the counterparty's cancellation instruction is processed in T2S.
Reason Code Reference	Shows the applicable reason code(s) for the cancellation of the settlement instruction, or an unsuccessful attempt of settlement.
Link	
Linkages	
Pool Instruction Reference	Shows the collective reference that identifies a set of messages.
Pool Instruction Counter	Shows the pool identification of the settlement instruction within the pool reference.
Pool Reference Owner BIC	Shows the BIC of the owner of the Pool Instruction Reference.
Link (List)	
Link Type	
Link Type	Shows the link processing position of the settlement instruction from the possible values: <input type="checkbox"/> After <input type="checkbox"/> Before <input type="checkbox"/> With <input type="checkbox"/> Info
Reference Type	Shows the reference type of the instruction to be linked/unlinked to from the possible values: <input type="checkbox"/> Account Owner Settlement Instruction Reference <input type="checkbox"/> Account Owner Intra Balance Movement Reference <input type="checkbox"/> Account Owner Intra Position Movement Reference <input type="checkbox"/> Account Servicer Reference <input type="checkbox"/> Third Party reference <input type="checkbox"/> T2S reference
Reference	Shows the identification of the instruction to be linked/unlinked to.

Settlement Instruction	
Reference Owner	Shows the BIC of the instructing party of the instruction to be linked/unlinked to. This field is only filled in if the 'Reference Type' is set to any value different than 'T2S reference'.
Use Of Restriction	
Cash Sub Balance Type	Shows a code defined by the CB to identify the restriction on cash.
Securities Sub Balance Type	Shows a code defined by the CSD to identify the restriction on securities. If it is a delivering instruction, the Delivering Securities Sub Balance Type is shown; if it is a receiving instruction, the Receiving Securities Sub Balance Type is shown.
Use Of Restriction (List)	
Restriction Reference	Shows the reference of a restricted cash balance or securities position included in the settlement instruction.
Additional Delivering Parties	
Delivering Party 3	
BIC	Shows the BIC of the client of the delivering CSD participant.
Name	Shows the name of the party.
Identification	Shows proprietary information, often a code, issued by the data source scheme issuer.
Issuer	Shows the entity that assigns the identification.
Schema Name	Shows a short textual description of the scheme.
Delivering Party 4	
BIC	Shows the BIC of the client of the delivering CSD participant.
Name	Shows the name of the party.
Identification	Shows proprietary information, often a code, issued by the data source scheme issuer.
Issuer	Shows the entity that assigns the identification.
Schema Name	Shows a short textual description of the scheme.
Delivering Party 5	
BIC	Shows the BIC of the client of the delivering CSD participant.

Settlement Instruction	
Name	Shows the name of the party.
Identification	Shows proprietary information, often a code, issued by the data source scheme issuer.
Issuer	Shows the entity that assigns the identification.
Schema Name	Shows a short textual description of the scheme.
Additional Receiving Parties	
Receiving Party 3	
BIC	Shows the BIC of the client of the receiving CSD participant.
Name	Shows the name of the party.
Identification	Shows proprietary information, often a code, issued by the data source scheme issuer.
Issuer	Shows the entity that assigns the identification.
Schema Name	Shows a short textual description of the scheme.
Receiving Party 4	
BIC	Shows the BIC of the client of the receiving CSD participant.
Name	Shows the name of the party.
Identification	Shows proprietary information, often a code, issued by the data source scheme issuer.
Issuer	Shows the entity that assigns the identification.
Schema Name	Shows a short textual description of the scheme.
Receiving Party 5	
BIC	Shows the BIC of the client of the receiving CSD participant.
Name	Shows the name of the party.
Identification	Shows proprietary information, often a code, issued by the data source scheme issuer.
Issuer	Shows the entity that assigns the identification.
Schema Name	Shows a short textual description of the scheme.
Other Information	
Deal Price	
Value Amount	Shows the value of the amount of the deal price.
Value Currency	Shows the currency of the amount of the deal price.

Settlement Instruction	
Value Rate	Shows the price expressed as a rate.
Value Type	Shows the type of value in which the price is expressed from the possible values: <ul style="list-style-type: none"> <input type="checkbox"/> Empty <input type="checkbox"/> Discount <input type="checkbox"/> Par <input type="checkbox"/> Premium
Yielded	Shows whether the price is expressed as a yield.
Foreign Exchange	
Exchange Rate	Shows the factor used for the conversion of an amount from one currency into another. This reflects the price at which one currency was bought with another currency.
Quoted Currency	Shows the currency into which the base currency is converted in a currency exchange.
Resulting Amount	Shows the counter value of a foreign exchange conversion.
Resulting Amount Currency	Shows the currency of the counter value of a foreign exchange conversion.
Unit Currency	Shows the currency into which the base currency is converted in a currency exchange for unit.
Place of Trade	
Place of Trade Description	Shows the market in which a trade transaction has been executed.
Place of Trade Market Identifier Code	Shows the Identifier Code of the market in which a trade transaction has been executed.
Place of Trade Code	Shows the Place of Trade information expressed as an ISO 20022 code from the possible values: <ul style="list-style-type: none"> <input type="checkbox"/> EXCH (for Stock Exchange) <input type="checkbox"/> OTCO (for Over the Counter) <input type="checkbox"/> PRIM (for Primary Market) <input type="checkbox"/> SECM (for Secondary Market) <input type="checkbox"/> VARI (for Various) <p>Either this field or the proprietary identification of the place of trade in addition to the issuer and scheme name is available.</p>

Settlement Instruction	
Issuer Name	Shows the entity that assigns the identification.
Proprietary Identification	Shows the identification assigned by an institution.
Schema Name	Shows the name of the identification scheme.
Other	
Number of Days Accrued	Shows the number of days on which the interest rate accrues.
Original Ordered Amount	Shows the original ordered amount.
Original Ordered Currency	Shows the currency of the original ordered amount.
Market Client Side Code	<p>Specifies if an instruction is for a market side or client side transaction:</p> <ul style="list-style-type: none"> <input type="checkbox"/> CLNT (for Client Side) <input type="checkbox"/> MAKT (for Market Side) <p>Either this field or the proprietary identification of the market client side in addition to the issuer and scheme name is available.</p>
Place of Clearing	Shows the BIC code of the Clearing House involved in the settlement (if any).

Buttons

Amendment Instruction	<p>This function enables you to create a new amendment instruction of the selected settlement instruction.</p> <p>This button is not available in case any status of the settlement instruction does not allow the creation of the amendment instruction.</p> <p>Next screen:</p> <ul style="list-style-type: none"> <input type="checkbox"/> <i>Amendment securities instruction – new</i> screen [▶ 103]
Hold/Release Instruction	<p>This function enables you to create a new hold/release/partial release instruction of the selected settlement instruction.</p> <p>This button is not available in case any status of the settlement instruction does not allow the creation of the hold/release/partial release instruction.</p> <p>Next screen:</p>

	<p><input type="checkbox"/> <i>Hold/release instruction – new screen</i> [▶ 126]</p>
Cancellation Instruction	<p>This function enables you to create a new cancellation instruction of the selected settlement instruction.</p> <p>This button is not available in case any status of the settlement instruction does not allow the creation of the cancellation instruction.</p> <p>Next screen:</p> <p><i>Cancellation securities instruction – new screen</i> [▶ 117]</p>
Revisions/Audit Trail	<p>This function enables you to display the revisions of the selected settlement instruction.</p> <p>Next screen:</p> <p><input type="checkbox"/> <i>Revisions/audit trail – list screen</i> [662]</p>
Status History	<p>This function enables you to display the status history of the selected settlement instruction.</p> <p>Next screen:</p> <p><input type="checkbox"/> <i>Status history – details screen</i> [▶ 267]</p>
Related Outbound Message	<p>This function enables you to display the outbound messages related to the settlement instruction.</p> <p>In case the instruction is linked to more than one outbound message, the <i>outbound messages - search/list</i> screen is displayed. In case the query only returns 1 valid message, the <i>outbound message – details</i> screen is displayed directly.</p> <p>Next screens:</p> <p><input type="checkbox"/> <i>Outbound messages – search/list screen</i> [646]</p> <p><input type="checkbox"/> <i>Outbound message – details screen</i> [▶ 654]</p>
Related Inbound Message	<p>This function enables you to display the inbound message related to the settlement instruction.</p> <p>Next screens:</p> <p><input type="checkbox"/> <i>Inbound messages – search/list screen</i> [▶ 629]</p> <p><input type="checkbox"/> <i>Inbound message – details screen</i> [▶ 636]</p>
Copy Instruction	<p>This function enables you to copy fields to create a new settlement instruction with the same attributes.</p> <p>Next screen:</p> <p><input type="checkbox"/> <i>Settlement instruction – new screen</i> [▶ 211]</p>

Associated Penalties	<p>This function enables you to display the details of the possible penalty(ies) associated to the Settlement Instruction:</p> <ul style="list-style-type: none"> <input type="checkbox"/> If there is only one result Penalty - details screen is displayed. <input type="checkbox"/> If there are more than one result Penalty – search/list - screen is displayed. <p>This function will not be available during the processing of penalties i.e. between the Events “PMSS” (Penalty Mechanism- Stop Screens and penalty modification requests) and “PMRR” (Penalty Mechanism- Restart GUI and Restart processing penalty modification requests).</p> <p>This function replicates the penalty query using as parameter the T2S Actor Reference or the T2S Reference of the underlying Settlement Instruction.</p> <p>This button shall be only visible for those having the privilege: “Penalty Query Privilege”. This privilege should be only granted to CSDs and the T2S Operator. To ensure it has not been granted by mistake to any other party, this button is only visible if the Party type of the User is “CSDY” or “TCSO”.</p> <p>Next screens:</p> <ul style="list-style-type: none"> <input type="checkbox"/> Penalty – search/list screen <input type="checkbox"/> Penalty – details screen
Links	<p>This function enables you to display all the links data preventing settlement at the moment when the request is performed.</p> <p>This button is not available in the following cases:</p> <ul style="list-style-type: none"> <input type="checkbox"/> Cancellation Status = “cancelled” <input type="checkbox"/> Settlement Status = “settled” <input type="checkbox"/> Match Status = “Unmatched” <p>Next screen:</p> <ul style="list-style-type: none"> <input type="checkbox"/> Links Preventing Settlement - screen [▶ 277]
Matched Instruction	<p>This function enables you to display the settlement instruction details of the matched business settlement instruction.</p>

<p>This button is not available in case the instruction is unmatched or if the user doesn't have the 'Settlement Instruction Query' privilege on the securities account of the counterparty.</p> <p>Next screen:</p> <ul style="list-style-type: none"> <input type="checkbox"/> Settlement instruction – details screen

2.2.2.19 Settlement Instruction - New Screen

Context of Usage

This screen contains a number of fields regarding settlement instructions. You can enter new data. Afterwards you can proceed further by clicking on the buttons below.

The screen can be used either in 2-eyes mode or 4-eyes mode.

This screen is not relevant for CB users.

Any schema validation error will be reported back to you for correction prior being able to leave the screen for further processing.

Alternatively you may cancel the action of entering the settlement instruction and leave the screen without clicking on the submit button.

Screen Access

- Securities >> Settlement >> Settlement Instruction >> *Settlement instructions – search/list* screen >> Click on *new* button
- Securities >> Settlement >> Settlement Instructions Allegements >> *Allegements instructions - search/list* screen >> Click on *search* button >> *Allegement instructions – search/list* screen >> Click on the *details* button >> *Allegement instruction – details* screen >> Click on the *new settlement instruction* button
- Securities >> Settlement >> Settlement Instruction >> *Settlement instructions – search/list* screen >> Click on *search* button >> *Settlement instructions – search/list* screen >> Select the relevant settlement instruction and click on the *details* button >> *Settlement instruction – details* screen >> Click on the *copy* button

Privileges

To use this screen, you need the following privileges [▶ 1228]:

- Send new settlement instruction/settlement restriction on securities either on a securities account or on behalf of an external CSD
- Send new instruction using a specific instructing party
- Send settlement Instruction with non-modifiable flag activated
- Link to an instruction / pool reference belonging to a specific party
- Use ISO transaction code AUTO (auto-collateralisation)

- Use ISO transaction code BYIY (buy-in)
- Use ISO transaction code BSBK (buy sell back)
- Use ISO transaction code CLAI (market claim)
- Use ISO transaction code CNCB (central bank collateral operation)
- Use ISO transaction code COLI (collateral in)
- Use ISO transaction code COLO (collateral out)
- Use ISO transaction code CONV (depository receipt conversion)
- Use ISO transaction code CORP (corporate action)
- Use ISO transaction code ETFT (exchange trade funds)
- Use ISO transaction code FCTA (factor update)
- Use ISO transaction code INSP (move of stock)
- Use ISO transaction code ISSU (issuance)
- Use ISO transaction code MKDW (mark down)
- Use ISO transaction code MKUP (mark up)
- Use ISO transaction code NETT (netting)
- Use ISO transaction code NSYN (non syndicated)
- Use ISO transaction code OWNE (external account transfer)
- Use ISO transaction code OWNI (internal account transfer)
- Use ISO transaction code PAIR (pair off)
- Use ISO transaction code PLAC (placement)
- Use ISO transaction code PORT (portfolio move)
- Use ISO transaction code REAL (realignment)
- Use ISO transaction code REDI (withdrawal)
- Use ISO transaction code REDM (redemption)
- Use ISO transaction code RELE (depository receipt release cancellation)
- Use ISO transaction code REPU (repo)
- Use ISO transaction code RODE (return delivery without matching)
- Use ISO transaction code RVPO (reverse repurchase agreement)
- Use ISO transaction code SBBK (sell buy back)
- Use ISO transaction code SBRE (borrowing reallocation)
- Use ISO transaction code SECB (securities borrowing)
- Use ISO transaction code SECL (securities lending)
- Use ISO transaction code SLRE (lending reallocation)

- Use ISO transaction code SUBS (subscription)
- Use ISO transaction code SWIF (switch from)
- Use ISO transaction code SWIT (switch to)
- Use ISO transaction code SYND (syndicate underwriters)
- Use ISO transaction code TBAC (TBA closing)
- Use ISO transaction code TRAD (trade)
- Use ISO transaction code TRPO (triparty repo)
- Use ISO transaction code TRVO (triparty reverse repo)
- Use ISO transaction code TURN (turnaround)
- Party hold settlement instruction on a securities account or on behalf of an external CSD
- CSD hold settlement instruction either on a securities account or on behalf of the CSD in T2S

References

User Instructions Part

This screen is part of the following business scenarios:

- Copy a settlement instruction [[▶ 731](#)]
- Enter a settlement instruction [[▶ 727](#)]
- Respond to an allegation instruction [[▶ 737](#)]

Business Functionality Document

This screen corresponds to the following business function:

- Add settlement instruction or settlement restriction (T2S.GUI.SESE.INX.0070)

Screenshot

Illustration 58: Settlement instruction - new screen

Field Description

General	
Securities Movement Type Code*	Select if the movement on the securities account results from a deliver or a receiver instruction from one of the possible values: <input type="checkbox"/> DELI <input type="checkbox"/> RECE

General	
	<p>References for error messages: [▶ 1382]</p> <ul style="list-style-type: none"> <input type="checkbox"/> MVCV237 <input type="checkbox"/> MVCV243 <input type="checkbox"/> MVCV248 <input type="checkbox"/> MVCV253 <input type="checkbox"/> MVCV271 <input type="checkbox"/> MVCV272 <input type="checkbox"/> MVCV279 <input type="checkbox"/> MVCV280 <input type="checkbox"/> MVCV281 <input type="checkbox"/> MVCV282 <input type="checkbox"/> MVCV287 <input type="checkbox"/> MVCV288 <input type="checkbox"/> MVCV298 <input type="checkbox"/> MVCV299 <input type="checkbox"/> MVCV305 <input type="checkbox"/> MVRR929 <input type="checkbox"/> MVRR941 <input type="checkbox"/> MVIC315 <input type="checkbox"/> MVIC316 <input type="checkbox"/> MVIC317 <input type="checkbox"/> MVIC318
<p>Securities Account Number*</p>	<p>You can choose to either enter the securities account number or to select it from the suggested items in the drop-down menu.</p> <p>Required format is: max. 35 characters (SWIFT-x)</p> <p>References for error messages: [▶ 1382]</p> <ul style="list-style-type: none"> <input type="checkbox"/> MVCP009 <input type="checkbox"/> MVCP010 <input type="checkbox"/> MVCP036 <input type="checkbox"/> MVCP037 <input type="checkbox"/> MVCP044

General	
	<input type="checkbox"/> MVCV271 <input type="checkbox"/> MVCV272 <input type="checkbox"/> MVCV273 <input type="checkbox"/> MVCV274 <input type="checkbox"/> MVCV275 <input type="checkbox"/> MVCV276 <input type="checkbox"/> MVCV277 <input type="checkbox"/> MVCV278 <input type="checkbox"/> MVCV279 <input type="checkbox"/> MVCV280 <input type="checkbox"/> MVCV281 <input type="checkbox"/> MVCV282 <input type="checkbox"/> MVCV305 <input type="checkbox"/> MVCA509 <input type="checkbox"/> MVCA510 <input type="checkbox"/> MVCA511 <input type="checkbox"/> MVR944 <input type="checkbox"/> MVIC315 <input type="checkbox"/> MVIC317 <input type="checkbox"/> MVIC318 <input type="checkbox"/> MVIC319 <input type="checkbox"/> MVIC320
Securities Account Owner BIC	<p>Enter the BIC of the securities account owner. Required format is: max. 11 characters (SWIFT-x) References for error messages: [▶ 1382]</p> <input type="checkbox"/> MVCV243 <input type="checkbox"/> MVCV253 <input type="checkbox"/> MVCV279 <input type="checkbox"/> MVCV281
	<p>If the 'Securities Movement Type Code' is set to 'RECE', and both the 'Securities Account Owner BIC' field and the 'Receiving CSD Participant – Party BIC' field are filled in, they must be the same. If the Securities Movement Type</p>

General	
	Code is set to DELI and both the 'Securities Account Owner BIC' field and the 'Delivering CSD Participant – Party BIC' field are filled in, they must be the same.
ISIN*	Select the ISIN of the security from the drop-down menu. References for error messages: [▶ 1382] <input type="checkbox"/> MVCV205 <input type="checkbox"/> MVCV298 <input type="checkbox"/> MVCV299 <input type="checkbox"/> MVCV301 <input type="checkbox"/> MVCV303 <input type="checkbox"/> MVIC305 <input type="checkbox"/> MVIC307 <input type="checkbox"/> MVIC308 <input type="checkbox"/> MVIC309 <input type="checkbox"/> MVIC311 <input type="checkbox"/> MVIC313 <input type="checkbox"/> MVIC315 <input type="checkbox"/> MVIC316 <input type="checkbox"/> MVIC317 <input type="checkbox"/> MVIC318 <input type="checkbox"/> MVIC319 <input type="checkbox"/> MVIC320 <input type="checkbox"/> MVSQ602 <input type="checkbox"/> MVSQ604 <input type="checkbox"/> MVSQ606 <input type="checkbox"/> MVR945
Securities Short Name	Shows the description of the selected ISIN. This field is automatically filled in when you have entered an ISIN in the 'ISIN' field.
Settlement Quantity*	Enter the quantity stated in the settlement instruction. Required format is: For settlement type = Unit, max. 15 digit(s) incl. decimal point (thereof max. 14 decimal places)

General	
	<p>For settlement type = Face Amount, max. 15 digit(s) incl. decimal point (thereof max. 5 decimal places)</p> <p>References for error messages: [▶ 1382]</p> <ul style="list-style-type: none"><input type="checkbox"/> MVCV286<input type="checkbox"/> MVSQ602<input type="checkbox"/> MVSQ604<input type="checkbox"/> MVSQ606<input type="checkbox"/> MVSQ610<input type="checkbox"/> MVSQ612 <p>In case there is no exchange of securities the value must be set to zero (i.e. for a PFOD the value needs to be set to '0' value).</p>
Settlement Type*	<p>Select the type of settlement foreseen for the securities from the possible values:</p> <ul style="list-style-type: none"><input type="checkbox"/> Units<input type="checkbox"/> Face Amount <p>References for error messages: [▶ 1382]</p> <ul style="list-style-type: none"><input type="checkbox"/> MVCV286<input type="checkbox"/> MVSQ604<input type="checkbox"/> MVSQ612 <p>This field is automatically filled in when an ISIN is chosen.</p>
Payment Type Code	<p>Select how the transaction is to be settled, against payment or free of payment from the possible values:</p> <ul style="list-style-type: none"><input type="checkbox"/> APMT<input type="checkbox"/> FREE <p>References for error messages: [▶ 1382]</p> <ul style="list-style-type: none"><input type="checkbox"/> MVCU103<input type="checkbox"/> MVCU107<input type="checkbox"/> MVCA105<input type="checkbox"/> MVCA503<input type="checkbox"/> MVCA505<input type="checkbox"/> MVCA507<input type="checkbox"/> MVCA511

General	
	<ul style="list-style-type: none"> <input type="checkbox"/> MVCA517 <input type="checkbox"/> MVCA518 <input type="checkbox"/> MVSD403 <input type="checkbox"/> MVSD406 <input type="checkbox"/> MVRR941 <input type="checkbox"/> MVRR942 <p>If the 'Payment Type Code' field is set to 'APMT', the 'Debit Credit Indicator' field must be filled in too.</p> <p>If the payment type code is set from 'APMT' to 'FREE', the fields 'Debit Credit Indicator', 'Currency' and 'Settlement Amount' become optional. Additionally, in case any data has been previously filled in any of these fields, it will be automatically removed upon the update of the payment type code from 'APMT' to 'FREE'. After the automatic deletion of the data, the fields can be filled in again.</p>
Debit Credit Indicator	<p>Select the relevant value when the original settlement amount has a value from the possible values:</p> <ul style="list-style-type: none"> <input type="checkbox"/> CRDT <input type="checkbox"/> DBIT <p>References for error messages: [▶ 1382]</p> <ul style="list-style-type: none"> <input type="checkbox"/> MVCV256 <input type="checkbox"/> MVCV257 <input type="checkbox"/> MVCA517 <input type="checkbox"/> MVCA518 <input type="checkbox"/> MVCA519 <p>In case the Payment Type Code is set to 'APMT' or the 'Settlement Amount' field is filled, the field Debit Credit indicator becomes mandatory.</p> <p>If the 'Debit Credit Indicator' field is filled, the 'Settlement Amount' field must be filled in too (and vice versa).</p>
T2S Dedicated Cash Account Number	<p>Enter the dedicated cash account number.</p> <p>In case the T2S dedicated cash account number is not filled in, T2S uses the default DCA stored in reference data for the relevant securities account and currency defined in the settlement instruction.</p>

General	
	<p>Required format is: max. 34 characters (SWIFT-x)</p> <p>References for error messages: [▶ 1382]</p> <ul style="list-style-type: none"> <input type="checkbox"/> MVCV256 <input type="checkbox"/> MVCV257 <input type="checkbox"/> MVCA105 <input type="checkbox"/> MVCA501 <input type="checkbox"/> MVCA502 <input type="checkbox"/> MVCA503 <input type="checkbox"/> MVCA505 <input type="checkbox"/> MVCA506 <input type="checkbox"/> MVCA507 <input type="checkbox"/> MVCA509 <input type="checkbox"/> MVCA510 <input type="checkbox"/> MVCA511 <input type="checkbox"/> MVCA514 <input type="checkbox"/> MVCA515 <input type="checkbox"/> MVCA516 <input type="checkbox"/> MVCA517 <input type="checkbox"/> MVCA518 <input type="checkbox"/> MVCA519 <input type="checkbox"/> MVRR947 <p>In case the payment type Code is set to 'APMT', and either the debtor cash account, if the instruction debits cash, or, the creditor cash account, if the instruction credits cash, is present, the dedicated cash account number becomes mandatory.</p>
Settlement Amount	<p>Enter the amount to be settled.</p> <p>Required format is: max. 15 digit(s)incl. decimal point (thereof max. 5 decimal places)</p> <p>References for error messages: [▶ 1382]</p> <ul style="list-style-type: none"> <input type="checkbox"/> MVCU107 <input type="checkbox"/> MVCV286 <input type="checkbox"/> MVCA514

General	
	<ul style="list-style-type: none"><input type="checkbox"/> MVCA515<input type="checkbox"/> MVCA516<input type="checkbox"/> MVSD403 <p>In case the Payment Type Code is set to 'APMT' or the 'Debit Credit Indicator' field is filled, the Settlement Amount becomes mandatory.</p> <p>If this field is filled, the 'Debit Credit Indicator' and 'Currency' fields must be filled in too (and vice versa).</p>
Currency	<p>Select the currency of the settlement instruction from the drop-down menu.</p> <p>This field needs to be filled in if the 'T2S Dedicated Cash Account Number' field is filled in.</p> <p>This field becomes mandatory when the 'Settlement Amount' field has been filled in.</p> <p>References for error messages: [▶ 1382]</p> <ul style="list-style-type: none"><input type="checkbox"/> MVCA105<input type="checkbox"/> MVCU101<input type="checkbox"/> MVCU103<input type="checkbox"/> MVCU107<input type="checkbox"/> MVCA514<input type="checkbox"/> MVCA515<input type="checkbox"/> MVCA516 <p>If this field is filled, the 'Settlement Amount' field becomes mandatory (and vice versa).</p>
Party Hold Status	<p>Select a hold status as set by the T2S party from the possible values:</p> <ul style="list-style-type: none"><input type="checkbox"/> Empty (default value)<input type="checkbox"/> PTYH: only the instructed leg is put on Party Hold<input type="checkbox"/> PRCY: only the T2S generated counterleg is put on Party Hold<input type="checkbox"/> BOTH: both legs are put on Party Hold<input type="checkbox"/> Released: No hold apply in both legs <p>References for error messages: [▶ 1382]</p> <ul style="list-style-type: none"><input type="checkbox"/> MVCP036

General	
	<ul style="list-style-type: none"><input type="checkbox"/> MVCP092<input type="checkbox"/> MVCP124<input type="checkbox"/> MVCP125 <p>The values selected for the 'Party Hold Status' and 'CSD Hold Status' must be consistent with each other. If one of them is set to 'On Hold', the other one can only be set to 'On Hold' or left empty, but it can never be set to 'Released' and vice versa.</p>
Party Hold Reason	<p>Enter the additional reason information of the Party Hold Status.</p> <p>Required format is: max. 210 characters</p> <p>This field is greyed out in case the 'Party Hold Status' is left empty.</p>
CSD Hold Status	<p>Select a hold status as set by the CSD from the possible values:</p> <ul style="list-style-type: none"><input type="checkbox"/> Empty (default value)<input type="checkbox"/> On Hold<input type="checkbox"/> Released <p>References for error messages: [▶ 1382]</p> <ul style="list-style-type: none"><input type="checkbox"/> MVCP037<input type="checkbox"/> MVCP038<input type="checkbox"/> MVCP126<input type="checkbox"/> MVCP127 <p>The values selected for the 'Party Hold Status' and 'CSD Hold Status' must be consistent with each other. If one of them is set to 'On Hold', the other one can only be set to 'On Hold' or left empty, but it can never be set to 'Released' and vice versa.</p>
CSD Hold Reason	<p>Enter the additional reason information of the CSD Hold Status.</p> <p>Required format is: max. 210 characters</p> <p>This field is greyed out in case the 'CSD Hold Status' is left empty.</p>
Partial Settlement Indicator	<p>Select to allow partial settlement from the possible values:</p> <ul style="list-style-type: none"><input type="checkbox"/> Empty (default value)

General	
	<ul style="list-style-type: none"><input type="checkbox"/> Partial not allowed<input type="checkbox"/> Partial settlement cash threshold allowed<input type="checkbox"/> Partial settlement quantity threshold allowed<input type="checkbox"/> Partial allowed
Transaction Identification*	<p>Enter an identification to unambiguously identify the instruction.</p> <p>Required format is: max. 16 characters (SWIFT-x-red)</p> <p>References for error messages: [▶ 1382]</p> <ul style="list-style-type: none"><input type="checkbox"/> MVDC002<input type="checkbox"/> MVDC004<input type="checkbox"/> MVDC006<input type="checkbox"/> MVDC014<input type="checkbox"/> MVDC016<input type="checkbox"/> MVDC018<input type="checkbox"/> MVDC020<input type="checkbox"/> MVDC021<input type="checkbox"/> MVSR701<input type="checkbox"/> MVSR702<input type="checkbox"/> MVSR703<input type="checkbox"/> MVSR704<input type="checkbox"/> MVSR707
Instructing Party Parent BIC	<p>Select the parent BIC of the instructing party from the drop-down menu or search via the <i>magnifier</i> icon.</p> <p>Required format is: max. 11 characters (SWIFT-x)</p> <p>References for error messages: [▶ 1382]</p> <ul style="list-style-type: none"><input type="checkbox"/> MCVV229<input type="checkbox"/> MVCP119<input type="checkbox"/> MVDC024<input type="checkbox"/> MCVV106<input type="checkbox"/> MCVV287<input type="checkbox"/> MCVV288<input type="checkbox"/> MCVV289

General	
	<ul style="list-style-type: none"> <input type="checkbox"/> MVDC002 <input type="checkbox"/> MVDC004 <input type="checkbox"/> MVDC006 <input type="checkbox"/> MVDC014 <input type="checkbox"/> MVDC016 <input type="checkbox"/> MVDC018 <input type="checkbox"/> MVDC021 <input type="checkbox"/> MVIC309 <input type="checkbox"/> MVIC313 <input type="checkbox"/> MVL1868 <p>In case the Instructing Party BIC is not entered, the Instructing Party BIC considered will be the party you belong to. If the Instructing Party Parent BIC is filled in, the Instructing Party BIC has to be filled in too.</p>
Instructing Party BIC	<p>Select the BIC of the instructing party via from the dropdown menu or search the <i>magnifier</i> icon.</p> <p>Required format is: max. 11 characters (SWIFT-x)</p> <p>References for error messages: [▶ 1382]</p> <ul style="list-style-type: none"> <input type="checkbox"/> MVCV229 <input type="checkbox"/> MVCP119 <input type="checkbox"/> MVDC024 <input type="checkbox"/> MVCV106 <input type="checkbox"/> MVCV287 <input type="checkbox"/> MVCV288 <input type="checkbox"/> MVCV289 <input type="checkbox"/> MVDC002 <input type="checkbox"/> MVDC004 <input type="checkbox"/> MVDC006 <input type="checkbox"/> MVDC014 <input type="checkbox"/> MVDC016 <input type="checkbox"/> MVDC018 <input type="checkbox"/> MVDC021 <input type="checkbox"/> MVIC309

General	
	<ul style="list-style-type: none"><input type="checkbox"/> MVIC313<input type="checkbox"/> MVLI868 <p>In case the Instructing Party BIC is not entered, the Instructing Party BIC considered will be the party you belong to. If the Instructing Party BIC is filled in, the Instructing Party Parent BIC has to be filled in too.</p>
Intended Settlement Date*	<p>Enter the date from which the instruction becomes eligible to be submitted to settlement or use the <i>calendar</i> icon.</p> <p>Required format is: YYYY-MM-DD</p> <p>References for error messages: [▶ 1382]</p> <ul style="list-style-type: none"><input type="checkbox"/> MVCV106<input type="checkbox"/> MVCV229<input type="checkbox"/> MVCV234<input type="checkbox"/> MVCV235<input type="checkbox"/> MVCV241<input type="checkbox"/> MVCV242<input type="checkbox"/> MVCV245<input type="checkbox"/> MVCV246<input type="checkbox"/> MVCV251<input type="checkbox"/> MVCV252<input type="checkbox"/> MVCV273<input type="checkbox"/> MVCV274<input type="checkbox"/> MVCV275<input type="checkbox"/> MVCV301<input type="checkbox"/> MVCV303<input type="checkbox"/> MVCA505<input type="checkbox"/> MVCA506<input type="checkbox"/> MVCA507<input type="checkbox"/> MVCA509<input type="checkbox"/> MVCA510<input type="checkbox"/> MVCA511<input type="checkbox"/> MVIC305<input type="checkbox"/> MVSD401

General	
	<input type="checkbox"/> MVSD403 <input type="checkbox"/> MVSD406 <input type="checkbox"/> MVSD411 <input type="checkbox"/> MVSD412 <input type="checkbox"/> MVLI813 <input type="checkbox"/> MVLI814 <input type="checkbox"/> MVLI815 <input type="checkbox"/> MVLI816 <input type="checkbox"/> MVLI817 <input type="checkbox"/> MVLI818 <input type="checkbox"/> MVLI831 <input type="checkbox"/> MVLI832 <input type="checkbox"/> MVLI833 <input type="checkbox"/> MVRR957 <input type="checkbox"/> MVRR960 <input type="checkbox"/> MVCA517 <input type="checkbox"/> MVCA518 <input type="checkbox"/> MVCV120 <input type="checkbox"/> MVCV121 <input type="checkbox"/> MVCV123 <input type="checkbox"/> MVIC307 <input type="checkbox"/> MVIC308 <input type="checkbox"/> MVIC311 <input type="checkbox"/> MVIC315 <input type="checkbox"/> MVIC316 <input type="checkbox"/> MVIC317 <input type="checkbox"/> MVIC318 <input type="checkbox"/> MVIC319 <input type="checkbox"/> MVIC320
Trade Date*	Enter the date when the contract was made or use the <i>calendar</i> icon. Required format is: YYYY-MM-DD

General	
	References for error messages: [▶ 1382] <input type="checkbox"/> MVSD401
Externally Matched*	Select if the settlement instruction is externally matched from the possible values: <input type="checkbox"/> Yes <input type="checkbox"/> No (default value) References for error messages: [▶ 1382] <input type="checkbox"/> MVCP010 <input type="checkbox"/> MVCV275 <input type="checkbox"/> MVCV278 <input type="checkbox"/> MVCV283 <input type="checkbox"/> MVCV003 <input type="checkbox"/> MVCV289 <input type="checkbox"/> MVCA501 <input type="checkbox"/> MVCA502 <input type="checkbox"/> MVCA503 <input type="checkbox"/> MVCA505 <input type="checkbox"/> MVCA506 <input type="checkbox"/> MVCA105 <input type="checkbox"/> MVCA507 <input type="checkbox"/> MVCA509 <input type="checkbox"/> MVCA510 <input type="checkbox"/> MVCA511 <input type="checkbox"/> MVCA514 <input type="checkbox"/> MVCA515 <input type="checkbox"/> MVCA516 <input type="checkbox"/> MVCP110 <input type="checkbox"/> MVCP124 <input type="checkbox"/> MVCP125 <input type="checkbox"/> MVCP126 <input type="checkbox"/> MVCP127 <input type="checkbox"/> MVIC319

General	
	<input type="checkbox"/> MVIC316 <input type="checkbox"/> MVIC320
Receiving Depository BIC	<p>Enter the BIC of the receiving depository. Required format is: max. 11 characters (SWIFT-x) References for error messages: [▶ 1382]</p> <input type="checkbox"/> MVCP011 <input type="checkbox"/> MVCP038 <input type="checkbox"/> MCVV006 <input type="checkbox"/> MCVV245 <input type="checkbox"/> MCVV246 <input type="checkbox"/> MCVV247 <input type="checkbox"/> MCVV248 <input type="checkbox"/> MCVV249 <input type="checkbox"/> MCVV250 <input type="checkbox"/> MCVV251 <input type="checkbox"/> MCVV252 <input type="checkbox"/> MCVV274 <input type="checkbox"/> MCVV277 <input type="checkbox"/> MCVV281 <input type="checkbox"/> MCVV282 <input type="checkbox"/> MCVV002 <input type="checkbox"/> MVIC305 <input type="checkbox"/> MVIC307 <input type="checkbox"/> MVIC308 <input type="checkbox"/> MCVV283 <input type="checkbox"/> MCVV288 <input type="checkbox"/> MCVV289 <input type="checkbox"/> MCVV299 <input type="checkbox"/> MVIC316 <input type="checkbox"/> MVCP127 <input type="checkbox"/> MVCP103 <input type="checkbox"/> MCVV003

General	
	<ul style="list-style-type: none"> <input type="checkbox"/> MVCV122 <input type="checkbox"/> MVCV283 <input type="checkbox"/> MVCV288 <input type="checkbox"/> MVCV289 <input type="checkbox"/> MVCV299 <input type="checkbox"/> MVCV278 <input type="checkbox"/> MVIC315 <p>The field 'Receiving Depository BIC' becomes mandatory if:</p> <ul style="list-style-type: none"> <input type="checkbox"/> The 'Securities Movement Type Code' is set to 'DELI'. <input type="checkbox"/> The 'Securities Movement Type Code' is set to 'RECE' and the settlement instruction is already matched cross-CSD
Receiving CSD Participant	
Party BIC	<p>Enter the BIC of the receiving CSD participant. Required format is: max. 11 characters (SWIFT-x) References for error messages: [▶ 1382]</p> <ul style="list-style-type: none"> <input type="checkbox"/> MVCV005 <input type="checkbox"/> MVCV248 <input type="checkbox"/> MVCV249 <input type="checkbox"/> MVCV250 <input type="checkbox"/> MVCV251 <input type="checkbox"/> MVCV252 <input type="checkbox"/> MVCV253 <input type="checkbox"/> MVCV282 <input type="checkbox"/> MVCV283 <input type="checkbox"/> MVCV122 <p>In case the 'Securities Movement Type Code' is set to 'DELI', the 'Receiving CSD participant – Party BIC' field becomes mandatory.</p> <p>If the Securities Movement Type Code is set to 'RECE', and the settlement instruction is already matched cross-CSD, the 'Receiving CSD participant – Party BIC' field becomes mandatory.</p>

General	
	<p>If the Securities Movement Type Code is set to RECE, and both the 'Securities Account Owner BIC' field and the 'Receiving CSD Participant – Party BIC' field are filled in, they must be the same.</p> <p>If the 'Receiving CSD Participant BIC' field is present, the 'Receiving Depository BIC' field must be present.</p>
Securities Account	<p>Enter the securities account of the receiving CSD participant.</p> <p>Required format is: max. 35 characters (SWIFT-x)</p> <p>References for error messages: [▶ 1382]</p> <ul style="list-style-type: none"> <input type="checkbox"/> MVCV282 <input type="checkbox"/> MVCP124 <input type="checkbox"/> MVCP125 <input type="checkbox"/> MVCP126 <input type="checkbox"/> MVCP044 <input type="checkbox"/> MVCV002 <input type="checkbox"/> MVCV003 <input type="checkbox"/> MVCV274 <input type="checkbox"/> MVCV275 <input type="checkbox"/> MVCV277 <input type="checkbox"/> MVCV281 <input type="checkbox"/> MVIC320 <p>This field becomes mandatory in case the settlement instruction is already matched and is delivering securities.</p>
Processing Identification	<p>Enter the reference of the instruction assigned by the receiving CSD participant.</p> <p>Required format is: max. 16 characters (SWIFT-x-red)</p>
Client of the Receiving CSD Participant	
Party BIC	<p>Enter BIC of the client of the receiving CSD participant.</p> <p>Required format is: max. 11 characters (SWIFT-x)</p> <p>Only one of the following party identifications can be filled in for a given settlement party: 'Party BIC', 'Name' or the combination of 'Identification', 'Issuer' and optionally 'Schema Name'.</p>

General	
	<p>References for error messages: [▶ 1382]</p> <ul style="list-style-type: none"><input type="checkbox"/> MVCV254<input type="checkbox"/> MVCV123 <p>If the 'Client of the Receiving CSD Participant – Party BIC' field is present the 'Receiving CSD Participant - Party BIC' field must be present.</p>
Name	<p>Enter the name and address of the client of the receiving CSD participant.</p> <p>Required format is: max. 140 characters (SWIFT-x)</p> <p>Only one of the following party identifications can be filled in for a given settlement party: 'Party BIC', 'Name' or the combination of 'Identification', 'Issuer' and optionally 'Schema Name'.</p>
Identification	<p>Enter the proprietary information, often a code, of the client of the receiving CSD participant.</p> <p>Required format is: max. 34 characters (SWIFT-x)</p> <p>Only one of the following party identifications can be filled in for a given settlement party: 'Party BIC', 'Name' or the combination of 'Identification', 'Issuer' and optionally 'Schema Name'.</p>
Issuer	<p>Enter the issuer identification of the client of the receiving CSD participant.</p> <p>Required format is: max. 4 characters (SWIFT-x)</p> <p>Only one of the following party identifications can be filled in for a given settlement party: 'Party BIC', 'Name' or the combination of 'Identification', 'Issuer' and optionally 'Schema Name'.</p>
Schema Name	<p>Enter a short textual description of the schema of the client of the receiving CSD participant.</p> <p>Required format is: max. 4 characters (SWIFT-x)</p> <p>Only one of the following party identifications can be filled in for a given settlement party: 'Party BIC', 'Name' or the combination of 'Identification', 'Issuer' and optionally 'Schema Name'.</p>
Securities Account	<p>Enter the securities account of the client of the receiving CSD participant.</p>

General	
	<p>Required format is: max. 35 characters (SWIFT-x)</p> <p>References for error messages: [▶ 1382]</p> <ul style="list-style-type: none"><input type="checkbox"/> MVCP044<input type="checkbox"/> MVCV271<input type="checkbox"/> MVCV273<input type="checkbox"/> MVCV275<input type="checkbox"/> MVCV276<input type="checkbox"/> MVCV280<input type="checkbox"/> MVCV001 <p>This field becomes mandatory in case the settlement instruction is already matched and is delivering securities.</p> <p>If the 'Client of the Receiving CSD Participant - Securities Account' field is present, one of the party identifiers for the client of the receiving CSD participant becomes mandatory.</p>
Delivering Depository BIC	<p>Enter the BIC of the delivering depository.</p> <p>Required format is: max. 11 characters (SWIFT-x)</p> <p>References for error messages: [▶ 1382]</p> <ul style="list-style-type: none"><input type="checkbox"/> MVCP011<input type="checkbox"/> MVCP038<input type="checkbox"/> MVCV008<input type="checkbox"/> MVCV234<input type="checkbox"/> MVCV235<input type="checkbox"/> MVCV236<input type="checkbox"/> MVCV237<input type="checkbox"/> MVCV238<input type="checkbox"/> MVCV239<input type="checkbox"/> MVCV241<input type="checkbox"/> MVCV242<input type="checkbox"/> MVCV273<input type="checkbox"/> MVCV276<input type="checkbox"/> MVCV278<input type="checkbox"/> MVCV279

General	
	<ul style="list-style-type: none"> <input type="checkbox"/> MVCV280 <input type="checkbox"/> MVCV001 <input type="checkbox"/> MVIC305 <input type="checkbox"/> MVIC307 <input type="checkbox"/> MVIC308 <input type="checkbox"/> MVCP102 <input type="checkbox"/> MVCV120 <input type="checkbox"/> MVCV298 <input type="checkbox"/> MVCV003 <input type="checkbox"/> MVCV283 <input type="checkbox"/> MVCV287 <input type="checkbox"/> MVCV289 <input type="checkbox"/> MVIC316 <input type="checkbox"/> MVCP127 <p>The field 'Delivering Depository BIC' becomes mandatory if:</p> <ul style="list-style-type: none"> <input type="checkbox"/> The 'Securities Movement Type Code' is set to 'RECE'. <input type="checkbox"/> The 'Securities Movement Type Code' is set to 'DELI' and the settlement instruction is already matched cross-CSD
Delivering CSD Participant	
Party BIC	<p>Enter the BIC of the delivering CSD participant.</p> <p>Required format is: max. 11 characters (SWIFT-x)</p> <p>References for error messages: [▶ 1382]</p> <ul style="list-style-type: none"> <input type="checkbox"/> MVCV007 <input type="checkbox"/> MVCV244 <input type="checkbox"/> MVCV120 <input type="checkbox"/> MVCV121 <input type="checkbox"/> MVCV237 <input type="checkbox"/> MVCV238 <input type="checkbox"/> MVCV239 <input type="checkbox"/> MVCV241 <input type="checkbox"/> MVCV242

General	
	<ul style="list-style-type: none"> <input type="checkbox"/> MVCV243 <input type="checkbox"/> MVCV280 <input type="checkbox"/> MVCV283 <p>In case the 'Securities Movement Type Code' is set to 'RECE', the 'Delivering CSD Participant – Party BIC' field becomes mandatory.</p> <p>If the Securities Movement Type Code is set to 'DELI', and the settlement instruction is already matched cross-CSD, the 'Delivering CSD participant – Party BIC' field becomes mandatory.</p> <p>If the 'Securities Movement Type Code' is set to 'DELI' and both the 'Securities Account Owner BIC' field and the 'Delivering CSD Participant – Party BIC' field are filled in, they must be the same.</p> <p>If the 'Delivering CSD Participant BIC' field is present, the 'Delivering Depository BIC' field must be present.</p>
Securities Account	<p>Enter the securities account of the delivering CSD participant.</p> <p>Required format is: max. 35 characters (SWIFT-x)</p> <p>References for error messages: [▶ 1382]</p> <ul style="list-style-type: none"> <input type="checkbox"/> MVCP044 <input type="checkbox"/> MVCV271 <input type="checkbox"/> MVCV273 <input type="checkbox"/> MVCV275 <input type="checkbox"/> MVCV276 <input type="checkbox"/> MVCV280 <input type="checkbox"/> MVCV001 <input type="checkbox"/> MVCV003 <input type="checkbox"/> MVCV272 <input type="checkbox"/> MVCV305 <input type="checkbox"/> MVCP124 <input type="checkbox"/> MVCP125 <input type="checkbox"/> MVCP126 <input type="checkbox"/> MVIC319

General	
	This field becomes mandatory in case the settlement instruction is already matched and is receiving securities.
Processing Identification	<p>Enter the reference of the instruction assigned by the delivering CSD participant.</p> <p>Required format is: max. 16 characters (SWIFT-x-red)</p> <p>References for error messages: [▶ 1382]</p> <p><input type="checkbox"/> MVCV244</p>
Client of the Delivering CSD Participant	
Party BIC	<p>Enter BIC of the client of the delivering CSD participant.</p> <p>Required format is: max. 11 characters (SWIFT-x)</p> <p>Only one of the following party identifications can be filled in for a given settlement party: 'Party BIC', 'Name' or the combination of 'Identification', 'Issuer' and optionally 'Schema Name'.</p> <p>References for error messages: [▶ 1382]</p> <p><input type="checkbox"/> MVCV244</p> <p>If the 'Client of the Delivering CSD Participant - Party BIC' field is present the 'Delivering CSD Participant – Party BIC' field must be present as well.</p>
Name	<p>Enter the name and address of the client of the delivering CSD participant.</p> <p>Required format is: max. 140 characters (SWIFT-x)</p> <p>Only one of the following party identifications can be filled in for a given settlement party: 'Party BIC', 'Name' or the combination of 'Identification', 'Issuer' and optionally 'Schema Name'.</p>
Identification	<p>Enter the proprietary information, often a code, of the client of the delivering CSD participant.</p> <p>Required format is: max. 34 characters (SWIFT-x)</p> <p>Only one of the following party identifications can be filled in for a given settlement party: 'Party BIC', 'Name' or the combination of 'Identification', 'Issuer' and optionally 'Schema Name'.</p>
Issuer	Enter the issuer identification of the client of the delivering CSD participant.

General	
	<p>Required format is: max. 4 characters (SWIFT-x)</p> <p>Only one of the following party identifications can be filled in for a given settlement party: 'Party BIC', 'Name' or the combination of 'Identification', 'Issuer' and optionally 'Schema Name'.</p>
Schema Name	<p>Enter a short textual description of the schema of the client of the delivering CSD participant.</p> <p>Required format is: max. 4 characters (SWIFT-x)</p> <p>Only one of the following party identifications can be filled in for a given settlement party: 'Party BIC', 'Name' or the combination of 'Identification', 'Issuer' and optionally 'Schema Name'.</p>
Securities Account	<p>Enter the securities account of the client of the delivering CSD participant.</p> <p>Required format is: max. 35 characters (SWIFT-x)</p> <p>If the 'Client of the Delivering CSD Participant - Securities Account' field is present, one of the party identifiers for the client of the delivering CSD participant becomes mandatory.</p>
Detailed Information	
Priority*	<p>Select the level of priority from the possible values:</p> <ul style="list-style-type: none"><input type="checkbox"/> Normal (default value)<input type="checkbox"/> High<input type="checkbox"/> Reserved <p>References for error messages:</p> <ul style="list-style-type: none"><input type="checkbox"/> MVSP208
Allowed Modification Flag	<p>Select, if the modification of the instruction by CSD participants is disallowed from the possible values:</p> <ul style="list-style-type: none"><input type="checkbox"/> Empty (default value)<input type="checkbox"/> TRUE: only the instructed leg can be modified / cancelled<input type="checkbox"/> FALSE:<ul style="list-style-type: none"><input type="checkbox"/> Already Matched SIs: the instructed leg cannot be modified / cancelled, but the T2S generated counter-leg can

General	
	<ul style="list-style-type: none"> <input type="checkbox"/> Unmatched SIs: the instructed leg cannot be modified / cancelled <input type="checkbox"/> NONE: neither the instructed nor the T2S generated leg can be modified / cancelled <input type="checkbox"/> BOTH: both legs can be modified / cancelled <p>References for error messages: [▶ 1382]</p> <ul style="list-style-type: none"> <input type="checkbox"/> MVCP012
Corporate Action Event Identification	<p>Enter the identification of the corporate action event.</p> <p>Required format is: max. 16 characters (SWIFT-x-red)</p>
Common Reference	<p>Enter the reference when the settlement instruction is already matched or in order to facilitate the matching within T2S.</p> <p>Required format is: max. 16 characters (SWIFT-x-red)</p>
Beneficial Ownership	<p>Select, if there is a change of beneficial ownership:</p> <ul style="list-style-type: none"> <input type="checkbox"/> Empty (default value) <input type="checkbox"/> Yes <input type="checkbox"/> No
Repo Reference	<p>Enter the identification of a collateral transaction.</p> <p>Required format is: max. 16 characters (SWIFT-x-red)</p>
Securities Transaction Type*	<p>Select the type of transaction from the possible values:</p> <ul style="list-style-type: none"> <input type="checkbox"/> AUTO (for auto-collateralisation) <input type="checkbox"/> BYIY (for buy-in) <input type="checkbox"/> BSBK (for buy sell back) <input type="checkbox"/> CLAI (for market claim) <input type="checkbox"/> CNCB (for central bank collateral operation) <input type="checkbox"/> COLI (for collateral in) <input type="checkbox"/> COLO (for collateral out) <input type="checkbox"/> CONV (for depository receipt conversion) <input type="checkbox"/> CORP (for corporate action) <input type="checkbox"/> FCTA (for factor update) <input type="checkbox"/> INSP (for move of stock) <input type="checkbox"/> ISSU (for depository receipt issue) <input type="checkbox"/> MKDW (for mark down)

General

- MKUP (for mark up)
- NETT (for netting)
- NSYN (for non syndicated)
- OWNE (for external account transfer)
- OWNI (for internal account transfer)
- PAIR (for pair off)
- PLAC (for placement)
- PORT (for portfolio move)
- REAL (for realignment)
- REDI (for withdrawal)
- REDM (for redemption)
- RELE (for depository receipt release cancellation)
- REPU (for repo)
- RODE (for return delivery without matching)
- RVPO (for reverse repurchase agreement)
- SBBK (for sell buy back)
- SBRE (for borrowing reallocation)
- SECB (for securities borrowing)
- SECL (for securities lending)
- SLRE (for lending reallocation)
- SUBS (for subscription)
- SWIF (Switch From)
- SWIT (Switch To)
- SYND (for syndicate underwriters)
- TBAC (for TBA closing)
- TRAD (for trade)
- TRPO (for triparty repo)
- TRVO (for triparty reverse repo)
- ETFT (for exchange trade funds)
- TURN (for turnaround)

References for error messages: [▶ 1382]

- MVCP052

General	
<input type="checkbox"/>	MVCP053
<input type="checkbox"/>	MVCP054
<input type="checkbox"/>	MVCP055
<input type="checkbox"/>	MVCP056
<input type="checkbox"/>	MVCP057
<input type="checkbox"/>	MVCP058
<input type="checkbox"/>	MVCP059
<input type="checkbox"/>	MVCP060
<input type="checkbox"/>	MVCP061
<input type="checkbox"/>	MVCP062
<input type="checkbox"/>	MVCP063
<input type="checkbox"/>	MVCP064
<input type="checkbox"/>	MVCP065
<input type="checkbox"/>	MVCP066
<input type="checkbox"/>	MVCP067
<input type="checkbox"/>	MVCP068
<input type="checkbox"/>	MVCP069
<input type="checkbox"/>	MVCP070
<input type="checkbox"/>	MVCP071
<input type="checkbox"/>	MVCP072
<input type="checkbox"/>	MVCP073
<input type="checkbox"/>	MVCP074
<input type="checkbox"/>	MVCP075
<input type="checkbox"/>	MVCP076
<input type="checkbox"/>	MVCP077
<input type="checkbox"/>	MVCP078
<input type="checkbox"/>	MVCP079
<input type="checkbox"/>	MVCP080
<input type="checkbox"/>	MVCP081
<input type="checkbox"/>	MVCP082
<input type="checkbox"/>	MVCP083
<input type="checkbox"/>	MVCP084

General	
	<ul style="list-style-type: none"><input type="checkbox"/> MVCP085<input type="checkbox"/> MVCP086<input type="checkbox"/> MVCP087<input type="checkbox"/> MVCP088<input type="checkbox"/> MVCP089<input type="checkbox"/> MVCP090<input type="checkbox"/> MVCP091<input type="checkbox"/> MVCP128<input type="checkbox"/> MVCP130<input type="checkbox"/> MVSQ602<input type="checkbox"/> MVSQ606<input type="checkbox"/> MVSQ610
Cum/EX Indicator	Select the cum/ex indicator from the possible values: <ul style="list-style-type: none"><input type="checkbox"/> Cum<input type="checkbox"/> Ex<input type="checkbox"/> Empty (default value)
Settlement Transaction Condition Indicator	Select the code condition under which the trade is going to be settled from the possible values: <ul style="list-style-type: none"><input type="checkbox"/> Empty (default value)<input type="checkbox"/> ADEA (accept after regular settlement deadline)<input type="checkbox"/> ASGN (assignment)<input type="checkbox"/> BUTC (buy to cover)<input type="checkbox"/> BSSP (buy in partially succesful)<input type="checkbox"/> CLEN (clean)<input type="checkbox"/> DIRT (dirty)<input type="checkbox"/> DLWM (delivery without matching)<input type="checkbox"/> DRAW (drawn)<input type="checkbox"/> EXER (exercised)<input type="checkbox"/> EXPI (expired)<input type="checkbox"/> FRCL (free clean settlement)<input type="checkbox"/> KNOC (knocked out)<input type="checkbox"/> NOMC (no automatic market claim)

General	
	<input type="checkbox"/> PENS (pending sale) <input type="checkbox"/> PHYS (physical) <input type="checkbox"/> RESI (residual) <input type="checkbox"/> RHYP (rehypothecation) <input type="checkbox"/> RPTO (reporting) <input type="checkbox"/> SHOR (short sell) <input type="checkbox"/> SPDL (special delivery) <input type="checkbox"/> SPST (split settlement) <input type="checkbox"/> TRAN (transformation) <input type="checkbox"/> TRIP (triparty segregation) <input type="checkbox"/> UNEX (unexposed)
Link	
Link Type	Select a link processing position of the possible values: <input type="checkbox"/> After (default value) <input type="checkbox"/> Before <input type="checkbox"/> With <input type="checkbox"/> Info References for error messages: [▶ 1382] <input type="checkbox"/> MVLI801 <input type="checkbox"/> MVLI802 <input type="checkbox"/> MVLI803 <input type="checkbox"/> MVLI813 <input type="checkbox"/> MVLI814 <input type="checkbox"/> MVLI815 <input type="checkbox"/> MVLI816 <input type="checkbox"/> MVLI817 <input type="checkbox"/> MVLI818 <input type="checkbox"/> MVLI831 <input type="checkbox"/> MVLI832 <input type="checkbox"/> MVLI833 <input type="checkbox"/> MVLI851 <input type="checkbox"/> MVLI854

General	
	<ul style="list-style-type: none"><input type="checkbox"/> MVL1857<input type="checkbox"/> MVL1860<input type="checkbox"/> MVL1863<input type="checkbox"/> MVL1865<input type="checkbox"/> MVCP013<input type="checkbox"/> MVL1875<input type="checkbox"/> MVL1872 <p>This field is also available as a show field for existing records.</p>
Reference Type	<p>Select the reference type of the instruction to be linked to from the possible values:</p> <ul style="list-style-type: none"><input type="checkbox"/> Account Owner Settlement Instruction Reference<input type="checkbox"/> Account Owner Intra Balance Movement Reference<input type="checkbox"/> Account Owner Intra Position Movement Reference<input type="checkbox"/> Account Servicer Reference<input type="checkbox"/> Third Party reference<input type="checkbox"/> T2S reference <p>Required format is: max. 46 characters (SWIFT-x)</p> <p>This field is also available as a show field for existing records.</p>
Reference	<p>Enter the identification of the instruction to be linked to.</p> <p>Required format is: max. 16 characters (SWIFT-x-red)</p> <p>References for error messages: [▶ 1382]</p> <ul style="list-style-type: none"><input type="checkbox"/> MVCP099<input type="checkbox"/> MVL1869<input type="checkbox"/> MVL1872 <p>This field is also available as a show field for existing records.</p>
Reference Owner	<p>Enter the BIC of the instructing party of the instruction to be linked to.</p> <p>Required format is: max. 11 characters (SWIFT-x)</p> <p>If the 'Reference Type' is set to any value different than 'T2S reference' this field becomes mandatory.</p>

General	
	This field is also available as a show field for existing records.
Options	Information on functions (icons) can be found in Common Buttons and Icons [▶ 43].
Pool Instruction Reference	<p>Enter the pool identification.</p> <p>Required format is: max. 16 characters (SWIFT-x-red)</p> <p>References for error messages: [▶ 1382]</p> <ul style="list-style-type: none"> <input type="checkbox"/> MVL1833 <input type="checkbox"/> MVL1847 <input type="checkbox"/> MVL1868
Pool Instruction Counter	<p>Enter the number of linked instructions included in the pool.</p> <p>Required format is: Integer</p> <p>References for error messages: [▶ 1382]</p> <ul style="list-style-type: none"> <input type="checkbox"/> MVL1843 <input type="checkbox"/> MVL1845 <p>This field becomes mandatory when the 'Pool Instruction Reference' is filled in.</p>
Current Instruction Number	<p>Enter the sequential number of the instruction.</p> <p>Required format is: Integer</p> <p>This field becomes mandatory when the 'Pool Instruction Reference' is filled in.</p>
Pool Reference Owner BIC	<p>Enter the BIC of the owner of the Pool Instruction Reference.</p> <p>Required format is: max. 11 characters (SWIFT-x)</p> <p>The field 'Pool Reference Owner BIC' becomes mandatory when the field 'Pool Instruction Reference' is filled in.</p>
Link Additional Information	
Message Number/ Long Number	<p>Enter the type number/message identified of the message referenced in the linkage sequence.</p> <p>Required format is: max. 12 characters</p>
Linked Quantity/ Paired Off Quantity/ Unit	Enter the quantity of the linked transaction to be paired-off expressed in units.

General	
	<p>Required format: max. 15 digit(s) incl. decimal point (thereof max. 14 decimal places).</p> <p>Only one of the values for quantity can be filled in: 'Unit', 'Face Amount' or 'Amortised Value'.</p> <p>If 'Paired Off Quantity' is filled in, then 'Turned Quantity' cannot be filled in.</p>
Linked Quantity/ Paired Off Quantity/ Face Amount	<p>Enter the quantity of the linked transaction to be paired-off expressed in face amount.</p> <p>Required format: max. 15 digit(s) incl. decimal point (thereof max. 5 decimal places).</p> <p>Only one of the values for quantity can be filled in: 'Unit', 'Face Amount' or 'Amortised Value'.</p> <p>If 'Paired Off Quantity' is filled in, then 'Turned Quantity' cannot be filled in.</p>
Linked Quantity/ Paired Off Quantity/ Amortised Value	<p>Enter the quantity of the linked transaction to be paired-off expressed in amortised value.</p> <p>Required format: max. 15 digit(s) incl. decimal point (thereof max. 5 decimal places).</p> <p>Only one of the values for quantity can be filled in: 'Unit', 'Face Amount' or 'Amortised Value'.</p> <p>If 'Paired Off Quantity' is filled in, then 'Turned Quantity' cannot be filled in.</p>
Linked Quantity/ Turned Quantity/Unit	<p>Enter the quantity of the linked transaction to be turned expressed in units.</p> <p>Required format: max. 15 digit(s) incl. decimal point (thereof max. 14 decimal places).</p> <p>Only one of the values for quantity can be filled in: 'Unit', 'Face Amount' or 'Amortised Value'.</p> <p>If 'Turned Quantity' is filled in, then 'Paired Off Quantity' cannot be filled in.</p>
Linked Quantity/ Turned Quantity/ Face Amount	<p>Enter the quantity of the linked transaction to be turned expressed in face amount.</p> <p>Required format: max. 15 digit(s) incl. decimal point (thereof max. 5 decimal places).</p> <p>Only one of the values for quantity can be filled in: 'Unit', 'Face Amount' or 'Amortised Value'.</p>

General	
	If 'Turned Quantity' is filled in, then 'Paired Off Quantity' cannot be filled in.
Linked Quantity/ Turned Quantity/ Amortised Value	<p>Enter the quantity of the linked transaction to be turned expressed in amortised value.</p> <p>Required format: max. 15 digit(s) incl. decimal point (thereof max. 5 decimal places).</p> <p>Only one of the values for quantity can be filled in: 'Unit', 'Face Amount' or 'Amortised Value'.</p> <p>If 'Turned Quantity' is filled in, then 'Paired Off Quantity' cannot be filled in.</p>
Use of Restriction	
Cash Sub Balance Type	<p>You can choose to either enter the code to identify the restriction on cash or to select it from the suggested items in the drop-down menu.</p> <p>Required format is: max. 4 characters (SWIFT-x)</p> <p>References for error messages: [▶ 1382]</p> <ul style="list-style-type: none"> <input type="checkbox"/> MVRR988 <input type="checkbox"/> MVRR926 <input type="checkbox"/> MVRR941 <input type="checkbox"/> MVRR957 <input type="checkbox"/> MVRR958
Delivering Securities Sub Balance Type	<p>You can choose to either enter the code to identify the restriction on securities or to select it from the suggested items in the drop-down menu. This field is only available if it is a delivering instruction or the field 'Externally Matched' is filled with 'Yes'.</p> <p>Required format is: max. 4 characters (SWIFT-x)</p> <p>References for error messages: [▶ 1382]</p> <ul style="list-style-type: none"> <input type="checkbox"/> MVRR937 <input type="checkbox"/> MVRR942 <input type="checkbox"/> MVRR948 <input type="checkbox"/> MVRR959 <input type="checkbox"/> MVRR960 <input type="checkbox"/> MVRR961

General	
	<input type="checkbox"/> MVRR963 <input type="checkbox"/> MVRR964 <input type="checkbox"/> MVRR986 <input type="checkbox"/> MVRR987
Receiving Securities Sub Balance Type	<p>You can choose to either enter the code to identify the restriction on securities or to select it from the suggested items in the drop-down menu. This field is only available if it is a receiving instruction or the field 'Externally Matched' is filled with 'Yes'.</p> <p>Required format is: max. 4 characters (SWIFT-x)</p> <p>References for error messages: [▶ 1382]</p> <input type="checkbox"/> MVRR929 <input type="checkbox"/> MVRR948 <input type="checkbox"/> MVRR962 <input type="checkbox"/> MVRR965 <input type="checkbox"/> MVRR972 <input type="checkbox"/> MVRR984
Restriction Reference	<p>Enter the restriction reference applying on securities.</p> <p>Required format is: max. 30 characters (SWIFT-x-red)</p> <p>References for error messages: [▶ 1382]</p> <input type="checkbox"/> MVRR934 <input type="checkbox"/> MVRR935 <input type="checkbox"/> MVRR936 <input type="checkbox"/> MVRR937 <input type="checkbox"/> MVRR941 <input type="checkbox"/> MVRR942 <input type="checkbox"/> MVRR944 <input type="checkbox"/> MVRR945 <input type="checkbox"/> MVRR947 <input type="checkbox"/> MVRR951 <input type="checkbox"/> MVRR963 <input type="checkbox"/> MVRR964 <input type="checkbox"/> MVRR984

General	
	<input type="checkbox"/> MVRR986 <input type="checkbox"/> MVRR987 Click on the '+' button to add a restriction reference.
Restriction Reference	Shows the restriction reference applying on securities. References for error messages: [▶ 1382] <input type="checkbox"/> MVRR934 <input type="checkbox"/> MVRR935 <input type="checkbox"/> MVRR936 <input type="checkbox"/> MVRR937 <input type="checkbox"/> MVRR941 <input type="checkbox"/> MVRR942 <input type="checkbox"/> MVRR944 <input type="checkbox"/> MVRR945 <input type="checkbox"/> MVRR947 <input type="checkbox"/> MVRR951 <input type="checkbox"/> MVRR963 <input type="checkbox"/> MVRR964 <input type="checkbox"/> MVRR984 <input type="checkbox"/> MVRR986 <input type="checkbox"/> MVRR987
Use of Restriction Additional Information	
Lot Quantity/Unit	Enter the quantity that is part of the lot described expressed in units. Required format: max. 15 digit(s) incl. decimal point (thereof max. 14 decimal places). Only one of the values for quantity can be filled in: 'Unit', 'Face Amount' or 'Amortised Value'.
Lot Quantity/Face Amount	Enter the quantity that is part of the lot described expressed in face amount. Required format: max. 15 digit(s) incl. decimal point (thereof max. 5 decimal places). Only one of the values for quantity can be filled in: 'Unit', 'Face Amount' or 'Amortised Value'.

General	
Lot Quantity/Amortised Value	<p>Enter the quantity that is part of the lot described expressed in amortised value.</p> <p>Required format: max. 15 digit(s) incl. decimal point (thereof max. 5 decimal places).</p> <p>Only one of the values for quantity can be filled in: 'Unit', 'Face Amount' or 'Amortised Value'.</p>
Lot Date Time/Date	<p>Enter the date on which the lot was purchased or use the <i>calendar</i> icon.</p> <p>Required format: YYYY-MM-DD</p> <p>Only one field among 'Date' and 'Date Time' can be filled in.</p>
Lot Date Time/Date Time	<p>Enter the date/time on which the lot was purchased or use the <i>calendar</i> icon.</p> <p>Required format: YYYY-MM-DD hh:mm:ss.µsµsµsµsµs</p> <p>Only one field among 'Date' and 'Date Time' can be filled in.</p>
Lot Price/Type/Yielded	<p>Select whether or not the price is expressed as a yield from the possible values:</p> <p><input type="checkbox"/> Yes</p> <p><input type="checkbox"/> No</p> <p>Only one field among 'Value Type' and 'Yielded' can be filled in.</p>
Lot Price/Type/Value Type	<p>Select the type of value in which the price is expressed from the possible values:</p> <p><input type="checkbox"/> Discount (default value)</p> <p><input type="checkbox"/> Premium</p> <p><input type="checkbox"/> Par</p> <p>Only one field among 'Value Type' and 'Yielded' can be filled in.</p>
Lot Price/Value/Rate	<p>Enter the price expressed as a rate.</p> <p>Required format is: max. 12 digit(s) incl. decimal point (thereof max. 10 decimal places)</p> <p>Only one field among 'Value Amount' and 'Value Rate' can be filled in.</p>

General	
Lot Price/Value/ Amount	<p>Enter the price expressed as a value.</p> <p>Required format is: max. 15 digit(s) incl. decimal point (thereof max. 13 decimal places)</p> <p>Only one field among 'Value Amount' and 'Value Rate' can be filled in.</p>
Lot Price/Value/Currency	<p>Select the currency of the value amount from the drop-down menu.</p> <p>Required format is: 3 characters (SWIFT-x)</p>
Type of Price/Code	<p>Select the ISO 20022 codes to indicate the type of price from the possible value:</p> <p><input type="checkbox"/> Average</p> <p>Only one of the following types can be filled in for a given place of trade:</p> <p>'Code' or the combination of 'Identification', 'Issuer' and optionally 'Schema Name'.</p>
Type of Price/Proprietary/Identification	<p>Enter the proprietary information, often a code, of the type of price.</p> <p>Required format is: max. 4 characters (SWIFT-x)</p> <p>Only one of the following types can be filled in for a given type of price:</p> <p>'Code' or the combination of 'Identification', 'Issuer' and optionally 'Schema Name'.</p>
Type of Price/Proprietary/Issuer	<p>Enter the issuer information of the type of price.</p> <p>Required format is: max. 4 characters (SWIFT-x)</p> <p>Only one of the following types can be filled in for a given type of price:</p> <p>'Code' or the combination of 'Identification', 'Issuer' and optionally 'Schema Name'.</p>
Type of Price/Proprietary/Schema Name	<p>Enter a short textual description of the schema of the type of price.</p> <p>Required format is: max. 4 characters (SWIFT-x)</p> <p>Only one of the following types can be filled in for a given type of price:</p> <p>'Code' or the combination of 'Identification', 'Issuer' and optionally 'Schema Name'.</p>

General	
Additional Receiving Parties	
Receiving Party 3	
Party BIC	<p>Enter the BIC of the client of the receiving CSD participant.</p> <p>Required format is: max. 11 characters (SWIFT-x)</p> <p>In case a BIC8 is entered for this field no automatic supplementation to BIC11 is performed.</p> <p>Only one of the following party identifications can be filled in for a given settlement party: 'Party BIC', 'Name' or the combination of 'Identification', 'Issuer' and optionally 'Schema Name'.</p>
Name	<p>Enter the name and address of the party.</p> <p>Required format is: max. 140 characters (SWIFT-x)</p> <p>Only one of the following party identifications can be filled in for a given settlement party: 'Party BIC', 'Name' or the combination of 'Identification', 'Issuer' and optionally 'Schema Name'.</p>
Proprietary Identification	<p>Enter the proprietary information, often a code, issued by the data source scheme issuer.</p> <p>Required format is: max. 34 characters (SWIFT-x)</p> <p>Only one of the following party identifications can be filled in for a given settlement party: 'Party BIC', 'Name' or the combination of 'Identification', 'Issuer' and optionally 'Schema Name'.</p>
Issuer	<p>Enter the entity that assigns the identification.</p> <p>Required format is: max. 4 characters (SWIFT-x)</p> <p>Only one of the following party identifications can be filled in for a given settlement party: 'Party BIC', 'Name' or the combination of 'Identification', 'Issuer' and optionally 'Schema Name'.</p>
Schema Name	<p>Enter the short textual description of the schema.</p> <p>Required format is: max. 4 characters (SWIFT-x)</p> <p>Only one of the following party identifications can be filled in for a given settlement party: 'Party BIC', 'Name' or the combination of 'Identification', 'Issuer' and optionally 'Schema Name'.</p>
Receiving Party 4	

General	
Party BIC	<p>Enter the BIC of the client of the receiving CSD participant.</p> <p>Required format is: max. 11 characters (SWIFT-x)</p> <p>In case a BIC8 is entered for this field no automatic supplementation to BIC11 is performed.</p> <p>Only one of the following party identifications can be filled in for a given settlement party: 'Party BIC', 'Name' or the combination of 'Identification', 'Issuer' and optionally 'Schema Name'.</p>
Name	<p>Enter the name and address of the party.</p> <p>Required format is: max. 140 characters (SWIFT-x)</p> <p>Only one of the following party identifications can be filled in for a given settlement party: 'Party BIC', 'Name' or the combination of 'Identification', 'Issuer' and optionally 'Schema Name'.</p>
Proprietary Identification	<p>Enter the proprietary information, often a code, issued by the data source scheme issuer.</p> <p>Required format is: max. 34 characters (SWIFT-x)</p> <p>Only one of the following party identifications can be filled in for a given settlement party: 'Party BIC', 'Name' or the combination of 'Identification', 'Issuer' and optionally 'Schema Name'.</p>
Issuer	<p>Enter the entity that assigns the identification.</p> <p>Required format is: max. 4 characters (SWIFT-x)</p> <p>Only one of the following party identifications can be filled in for a given settlement party: 'Party BIC', 'Name' or the combination of 'Identification', 'Issuer' and optionally 'Schema Name'.</p>
Schema Name	<p>Enter the short textual description of the schema.</p> <p>Required format is: max. 4 characters (SWIFT-x)</p> <p>Only one of the following party identifications can be filled in for a given settlement party: 'Party BIC', 'Name' or the combination of 'Identification', 'Issuer' and optionally 'Schema Name'.</p>
Receiving Party 5	
Party BIC	<p>Enter the BIC of the client of the receiving CSD participant.</p> <p>Required format is: max. 11 characters (SWIFT-x)</p>

General	
	<p>In case a BIC8 is entered for this field no automatic supplementation to BIC11 is performed.</p> <p>Only one of the following party identifications can be filled in for a given settlement party: 'Party BIC', 'Name' or the combination of 'Identification', 'Issuer' and optionally 'Schema Name'.</p>
Name	<p>Enter the name and address of the party.</p> <p>Required format is: max. 140 characters (SWIFT-x)</p> <p>Only one of the following party identifications can be filled in for a given settlement party: 'Party BIC', 'Name' or the combination of 'Identification', 'Issuer' and optionally 'Schema Name'.</p>
Proprietary Identification	<p>Enter the proprietary information, often a code, issued by the data source scheme issuer.</p> <p>Required format is: max. 34 characters (SWIFT-x)</p> <p>Only one of the following party identifications can be filled in for a given settlement party: 'Party BIC', 'Name' or the combination of 'Identification', 'Issuer' and optionally 'Schema Name'.</p>
Issuer	<p>Enter the entity that assigns the identification.</p> <p>Required format is: max. 4 characters (SWIFT-x)</p> <p>Only one of the following party identifications can be filled in for a given settlement party: 'Party BIC', 'Name' or the combination of 'Identification', 'Issuer' and optionally 'Schema Name'.</p>
Schema Name	<p>Enter the short textual description of the schema.</p> <p>Required format is: max. 4 characters (SWIFT-x)</p> <p>Only one of the following party identifications can be filled in for a given settlement party: 'Party BIC', 'Name' or the combination of 'Identification', 'Issuer' and optionally 'Schema Name'.</p>
Additional Delivering Parties	
Delivering Party 3	
Party BIC	<p>Enter the BIC of the client of the delivering CSD participant.</p> <p>Required format is: max. 11 characters (SWIFT-x)</p>

General	
	<p>In case a BIC8 is entered for this field no automatic supplementation to BIC11 is performed.</p> <p>Only one of the following party identifications can be filled in for a given settlement party: 'Party BIC', 'Name' or the combination of 'Identification', 'Issuer' and optionally 'Schema Name'.</p>
Name	<p>Enter the name and address of the party.</p> <p>Required format is: max. 140 characters (SWIFT-x)</p> <p>Only one of the following party identifications can be filled in for a given settlement party: 'Party BIC', 'Name' or the combination of 'Identification', 'Issuer' and optionally 'Schema Name'.</p>
Proprietary Identification	<p>Enter the proprietary information, often a code, issued by the data source scheme issuer.</p> <p>Required format is: max. 34 characters (SWIFT-x)</p> <p>Only one of the following party identifications can be filled in for a given settlement party: 'Party BIC', 'Name' or the combination of 'Identification', 'Issuer' and optionally 'Schema Name'.</p>
Issuer	<p>Enter the entity that assigns the identification.</p> <p>Required format is: max. 4 characters (SWIFT-x)</p> <p>Only one of the following party identifications can be filled in for a given settlement party: 'Party BIC', 'Name' or the combination of 'Identification', 'Issuer' and optionally 'Schema Name'.</p>
Schema Name	<p>Enter the short textual description of the schema.</p> <p>Required format is: max. 4 characters (SWIFT-x)</p> <p>Only one of the following party identifications can be filled in for a given settlement party: 'Party BIC', 'Name' or the combination of 'Identification', 'Issuer' and optionally 'Schema Name'.</p>
Delivering Party 4	
Party BIC	<p>Enter the BIC of the client of the delivering CSD participant.</p> <p>Required format is: max. 11 characters (SWIFT-x)</p>

General	
	<p>In case a BIC8 is entered for this field no automatic supplementation to BIC11 is performed.</p> <p>Only one of the following party identifications can be filled in for a given settlement party: 'Party BIC', 'Name' or the combination of 'Identification', 'Issuer' and optionally 'Schema Name'.</p>
Name	<p>Enter the name and address of the party.</p> <p>Required format is: max. 140 characters (SWIFT-x)</p> <p>Only one of the following party identifications can be filled in for a given settlement party: 'Party BIC', 'Name' or the combination of 'Identification', 'Issuer' and optionally 'Schema Name'.</p>
Proprietary Identification	<p>Enter the proprietary information, often a code, issued by the data source scheme issuer.</p> <p>Required format is: max. 34 characters (SWIFT-x)</p> <p>Only one of the following party identifications can be filled in for a given settlement party: 'Party BIC', 'Name' or the combination of 'Identification', 'Issuer' and optionally 'Schema Name'.</p>
Issuer	<p>Enter the entity that assigns the identification.</p> <p>Required format is: max. 4 characters (SWIFT-x)</p> <p>Only one of the following party identifications can be filled in for a given settlement party: 'Party BIC', 'Name' or the combination of 'Identification', 'Issuer' and optionally 'Schema Name'.</p>
Schema Name	<p>Enter the short textual description of the schema.</p> <p>Required format is: max. 4 characters (SWIFT-x)</p> <p>Only one of the following party identifications can be filled in for a given settlement party: 'Party BIC', 'Name' or the combination of 'Identification', 'Issuer' and optionally 'Schema Name'.</p>
Delivering Party 5	
Party BIC	<p>Enter the BIC of the client of the delivering CSD participant.</p> <p>Required format is: max. 11 characters (SWIFT-x)</p>

General	
	<p>In case a BIC8 is entered for this field no automatic supplementation to BIC11 is performed.</p> <p>Only one of the following party identifications can be filled in for a given settlement party: 'Party BIC', 'Name' or the combination of 'Identification', 'Issuer' and optionally 'Schema Name'.</p>
Name	<p>Enter the name and address of the party.</p> <p>Required format is: max. 140 characters (SWIFT-x)</p>
Proprietary Identification	<p>Enter the proprietary information, often a code, issued by the data source scheme issuer.</p> <p>Required format is: max. 34 characters (SWIFT-x)</p> <p>Only one of the following party identifications can be filled in for a given settlement party: 'Party BIC', 'Name' or the combination of 'Identification', 'Issuer' and optionally 'Schema Name'.</p>
Issuer	<p>Enter the entity that assigns the identification.</p> <p>Required format is: max. 4 characters (SWIFT-x)</p> <p>Only one of the following party identifications can be filled in for a given settlement party: 'Party BIC', 'Name' or the combination of 'Identification', 'Issuer' and optionally 'Schema Name'.</p>
Schema Name	<p>Enter the short textual description of the schema.</p> <p>Required format is: max. 4 characters (SWIFT-x)</p> <p>Only one of the following party identifications can be filled in for a given settlement party: 'Party BIC', 'Name' or the combination of 'Identification', 'Issuer' and optionally 'Schema Name'.</p>
Other Information	
Deal Price	
Value Amount	<p>Enter the value of the amount of the deal price.</p> <p>Required format is: max. 15 digit(s) incl. decimal point (thereof max. 13 decimal places)</p> <p>Only one field among 'Value Amount' and 'Value Rate' can be filled in. If any of these two fields is filled in the other one cannot be filled in.</p>

General	
	If either 'Value Amount' or 'Value Rate' is filled in, then either 'Value Type' or 'Yielded' must also be filled in.
Value Currency	Select the currency of the amount of the deal price from the possible values. Required format is: 3 characters (SWIFT-x)
Value Rate	Enter the price expressed as a rate. Required format is: max. 12 digit(s) incl. decimal point (thereof max. 10 decimal places) Only one field among 'Value Amount' and 'Value Rate' can be filled in. If any of these two fields is filled in the other one cannot be filled in. If either 'Value Amount' or 'Value Rate' is filled in, then either 'Value Type' or 'Yielded' must also be filled in.
Value Type	Select the type of value in which the price is expressed from the possible values: <input type="checkbox"/> Empty (default value) <input type="checkbox"/> Discount <input type="checkbox"/> Par <input type="checkbox"/> Premium Only one field among 'Value Type' and 'Yielded' can be filled in. If any of these two fields is filled in the other one cannot be filled in. If either 'Value Type' or 'Yielded' is filled in, then either 'Value Amount' or 'Value Rate' must also be filled in.
Yielded	Select yes or no to indicate that the price is expressed as a yield. Possible values: <input type="checkbox"/> Empty (default value) <input type="checkbox"/> Yes <input type="checkbox"/> No Only one field among 'Value Type' and 'Yielded' can be filled in. If any of these two fields is filled in the other one cannot be filled in. If either 'Value Type' or 'Yielded' is filled in, then either 'Value Amount' or 'Value Rate' must also be filled in.

General	
Foreign Exchange	
Exchange Rate	Enter the factor used for the conversion of an amount from one currency into another. This reflects the price at which one currency was bought with another currency. Required format is: max. 12 digit(s) incl. decimal point (thereof max. 10 decimal places)
Quoted Currency	Select the currency into which the base currency is converted, in a currency exchange from the drop-down menu.
Resulting Amount	Enter the counter value of a foreign exchange conversion. Required format is: max. 15 digit(s) incl. decimal point (thereof max. 5 decimal places)
Resulting Amount Currency	Select the currency of the counter value of a foreign exchange conversion from the drop-down menu.
Unit Currency	Select the currency into which the base currency is converted, in a currency exchange for unit from the drop-down menu.
Place of Trade	
Place of Trade Description	Enter the description of the market in which a trade transaction has been executed. Either this field or Place of Trade Market Identifier Code can be filled, but not both. Required format is: max. 30 characters (SWIFT-x-red)
Place of Trade Market Identifier Code	Enter the Identifier Code of the market in which a trade transaction has been executed. Either this field or Place of Trade Description can be filled, but not both. Required format is: max. 4 characters (SWIFT-x)
Place of Trade Additional Information	
Type/Code	Select the ISO 20022 code to indicate the type of market in which transactions take place from the possible values: <input type="checkbox"/> PRIM (for Primary Market) <input type="checkbox"/> SECM (for Secondary Market) <input type="checkbox"/> OTCO (for Over the Counter)

General	
	<input type="checkbox"/> VARI (for Various) <input type="checkbox"/> EXCH (for Stock Exchange) Required format is: max. 4 characters (SWIFT-x). In case either 'Place of Trade Description' or 'Place of Trade Market Identifier Code' are filled, either 'Place of Trade Code' or Proprietary Information must be provided. Only one of the following types can be filled in for a given place of trade: 'Code' or the combination of 'Identification', 'Issuer' and optionally 'Schema Name'.
Type/Proprietary/Identification	Enter the proprietary information, often a code, of the place of trade type. Required format is: max. 4 characters (SWIFT-x). Only one of the following types can be filled in for a given place of trade: 'Code' or the combination of 'Identification', 'Issuer' and optionally 'Schema Name'.
Type/Proprietary/Issuer	Enter the issuer information of the place of trade type. Required format is: max. 4 characters (SWIFT-x). Only one of the following types can be filled in for a given place of trade: 'Code' or the combination of 'Identification', 'Issuer' and optionally 'Schema Name'.
Type/Proprietary/Schema Name	Enter a short textual description of the schema of the place of trade type. Required format is: max. 4 characters (SWIFT-x). Only one of the following types can be filled in for a given place of trade: 'Code' or the combination of 'Identification', 'Issuer' and optionally 'Schema Name'.
Other Information	
Other	
Number of Days Accrued	Enter the number of days on which the interest rate accrues (daily accrual note). Required format is: Integer values from -999 to 999

General	
Original Ordered Amount	Enter the original ordered amount. Required format is: max. 15 digit(s) incl. decimal point (thereof max. 5 decimal places)
Original Ordered Currency	Select the currency of the original ordered amount from the drop-down menu.
Market Client Side Code	Specifies if an instruction is for a market side or client side transaction: <input type="checkbox"/> CLNT (for Client Side) <input type="checkbox"/> MAKT (for Market Side) Either this field or the proprietary identification of the market client side in addition to the issuer and scheme name is available. Required format is: max. 4 characters (SWIFT-x)
Market Client Side Proprietary Identification	Select the identification assigned by an institution. In case Proprietary Information is filled, at least Identification and Issuer must be provided. Required format is: max. 4 characters (SWIFT-x)
Market Client Side Issuer	Select the entity that assigns the identification. In case Proprietary Information is filled, at least Identification and Issuer must be provided. Required format is: max. 4 characters (SWIFT-x)
Market Client Side Schema Name	Select the name of the identification scheme. Required format is: max. 4 characters (SWIFT-x)
Additional Information	
Level 1	Select the first level of the XML hierarchy.
Level 2	Select the second level of the XML hierarchy.
Level 3	Select the third level of the XML hierarchy.
Level 4	Select the fourth level of the XML hierarchy.
Level 5	Select the fifth level of the XML hierarchy.
Level 6	Select the sixth level of the XML hierarchy.
Value	Enter the value of the corresponding XML field chosen through the different levels.
Path	Shows the XML selected hierarchy.

General	
Value	Shows the value of the corresponding XML field chosen through the different levels.

Buttons

Cancel	<p>This function enables you to cancel the process and return to the previous screen.</p> <p>Next screen:</p> <ul style="list-style-type: none"><input type="checkbox"/> <i>Settlement instructions – search/list</i> screen [▶ 177]
Reset	<p>This function enables you to set all fields to default value and blanks out all optional fields.</p> <p>Next screen:</p> <ul style="list-style-type: none"><input type="checkbox"/> <i>Settlement instruction – new</i> screen
Submit	<p>This function enables you to create a new settlement instruction. Upon clicking on the <i>submit</i> button you will be asked to enter your PIN for digital signature purposes (NRO). With the entry of the PIN, T2S attaches a digital signature to the instruction entered by the T2S actor.</p> <p>Next screen:</p> <ul style="list-style-type: none"><input type="checkbox"/> <i>Settlement instructions – search/list</i> screen [▶ 177] <p>References for error messages: [▶ 1382]</p> <ul style="list-style-type: none"><input type="checkbox"/> MVCA105<input type="checkbox"/> MVCA501<input type="checkbox"/> MVCA502<input type="checkbox"/> MVCA503<input type="checkbox"/> MVCA505<input type="checkbox"/> MVCA506<input type="checkbox"/> MVCA507<input type="checkbox"/> MVCA509<input type="checkbox"/> MVCA510<input type="checkbox"/> MVCA511<input type="checkbox"/> MVCA514<input type="checkbox"/> MVCA515<input type="checkbox"/> MVCA516

- MVCA517
- MVCA518
- MVCA519
- MVCP009
- MVCP010
- MVCP011
- MVCP012
- MVCP013
- MVCP036
- MVCP037
- MVCP052
- MVCP053
- MVCP054
- MVCP055
- MVCP056
- MVCP057
- MVCP058
- MVCP059
- MVCP060
- MVCP061
- MVCP062
- MVCP063
- MVCP064
- MVCP065
- MVCP066
- MVCP067
- MVCP068
- MVCP069
- MVCP070
- MVCP071
- MVCP072
- MVCP073

- MVCP074
- MVCP075
- MVCP076
- MVCP077
- MVCP078
- MVCP079
- MVCP080
- MVCP081
- MVCP082
- MVCP083
- MVCP084
- MVCP085
- MVCP086
- MVCP087
- MVCP088
- MVCP089
- MVCP090
- MVCP091
- MVCP092
- MVCP099
- MVCP102
- MVCP103
- MVCP110
- MVCP119
- MVCP124
- MVCP125
- MVCP126
- MVCP127
- MVCP128
- MVCP130
- MVCU103
- MVCU107

- MVCV001
- MVCV002
- MVCV003
- MVCV106
- MVCV120
- MVCV122
- MVCV123
- MVCV205
- MVCV229
- MVCV234
- MVCV235
- MVCV236
- MVCV237
- MVCV238
- MVCV239
- MVCV241
- MVCV242
- MVCV243
- MVCV244
- MVCV245
- MVCV246
- MVCV247
- MVCV248
- MVCV249
- MVCV250
- MVCV251
- MVCV252
- MVCV253
- MVCV256
- MVCV257
- MVCV271
- MVCV272

- MVCV273
- MVCV274
- MVCV275
- MVCV276
- MVCV277
- MVCV278
- MVCV279
- MVCV280
- MVCV281
- MVCV282
- MVCV283
- MVCV286
- MVCV287
- MVCV288
- MVCV289
- MVCV298
- MVCV299
- MVCV301
- MVCV303
- MVCV305
- MVDC002
- MVDC004
- MVDC006
- MVDC014
- MVDC016
- MVDC018
- MVDC021
- MVDC024
- MVIC305
- MVIC307
- MVIC308
- MVIC309

- MVIC311
- MVIC313
- MVIC315
- MVIC316
- MVIC317
- MVIC318
- MVIC319
- MVIC320
- MVLI801
- MVLI802
- MVLI803
- MVLI813
- MVLI814
- MVLI815
- MVLI816
- MVLI817
- MVLI818
- MVLI831
- MVLI832
- MVLI833
- MVLI843
- MVLI845
- MVLI847
- MVLI851
- MVLI854
- MVLI857
- MVLI860
- MVLI863
- MVLI865
- MVLI868
- MVLI869
- MVLI872

- MVLI875
- MVRR926
- MVRR929
- MVRR934
- MVRR935
- MVRR936
- MVRR937
- MVRR941
- MVRR942
- MVRR944
- MVRR945
- MVRR947
- MVRR948
- MVRR951
- MVRR957
- MVRR958
- MVRR959
- MVRR960
- MVRR961
- MVRR963
- MVRR964
- MVRR984
- MVRR986
- MVRR987
- MVSD401
- MVSD403
- MVSD406
- MVSD411
- MVSD412
- MVSP208
- MVSQ602
- MVSQ604

<input type="checkbox"/>	MVSQ606
<input type="checkbox"/>	MVSQ610
<input type="checkbox"/>	MVSQ612
<input type="checkbox"/>	MVSR701
<input type="checkbox"/>	MVSR702
<input type="checkbox"/>	MVSR703
<input type="checkbox"/>	MVSR704
<input type="checkbox"/>	MVSR707

2.2.2.20 Status History - Details Screen

Context of Usage

This screen displays detailed information on the status history of the selected instruction. You can check the data.

There is no usage restriction for this screen.

Screen Access

- Securities >> Settlement >> Intra-Position Movements >> *Intra-position movements with current and historical status – search* screen >> Click on the *search* button >> *Intra-position movements – list* screen >> Click on the *details* button >> *Intra-position movement - details* screen >> Click on the *status history* button
- Securities >> Settlement >> Intra-Balance Movements >> *Intra-balance movements with current and historical status – search* screen >> Click on the *search* button >> *Intra-balance movements – list* screen >> Click on the *details* button >> *Intra-balance movement - details* screen >> Click on the *status history* button
- Securities >> Settlement >> Settlement Instructions >> *Settlement instructions with current and historical status – search* screen >> Click on the *search* button >> *Settlement instructions – list* screen >> Click on the *details* button >> *Settlement instruction – details* screen >> Click on the *status history* button
- Securities >> Settlement >> Maintenance Securities Instructions >> *Maintenance securities instructions - search* screen >> Click on the *search* button >> *Maintenance securities instructions - list* screen >> Click on the *details* button >> *Amendment securities instruction – details* screen >> Click on the *status history* button

- Securities >> Settlement >> Maintenance Securities Instructions >> *Maintenance securities instructions - search* screen >> Click on the *search* button >> *Maintenance securities instructions - list* screen >> Click on the *details* button >> *Cancellation securities instruction – details* screen >> Click on the *status history* button
- Securities >> Settlement >> Maintenance Securities Instructions >> *Maintenance securities instructions - search* screen >> Click on the *search* button >> *Maintenance securities instructions - list* screen >> Click on the *details* button >> *Hold/release Instruction – details* screen >> Click on the *status history* button
- Cash >> Settlement >> Maintenance Cash Instructions >> *Maintenance cash instructions - search* screen >> Click on the *search* button >> *Maintenance cash instructions - list* screen >> Click on the *details* button >> *Amendment cash instruction – details* screen >> Click on the *status history* button
- Cash >> Settlement >> Maintenance Cash Instructions >> *Maintenance cash instructions - search* screen >> Click on the *search* button >> *Maintenance cash instructions - list* screen >> Click on the *details* button >> *Cancellation cash instruction – details* screen >> Click on the *status history* button

Privileges To use this screen, you need the privileges necessary for the business object for which you want to view the status history.

References **User Instructions Part**

This screen is part of the following business scenario:

- View settlement instruction status history [▶ 773]

Business Functionality Document

This screen corresponds to the following business function:

- Display instruction details (T2S.GUI.SESE.INX.0030)

Screenshot

Status History				
Instruction		Effective		
1810150291929194		2018-12-21 17:42:57		
Rows per page: 10 page 1 of 2 - lines 1 to 10 of 14 Go to page: 1				
Date and Time	Status Type	Status Value	Settled Settlement Amount	Settled Settlement Quantity
2018-10-19 09:13:43	Settlement Status	Settled		1
2018-10-18 19:39:16	Settlement Status	Unsettled - Failing		
2018-10-18 19:33:26	Settlement Status	Unsettled - Failing		
2018-10-18 19:19:41	Settlement Status	Unsettled - Failing		
2018-10-16 11:23:28	Settlement Status	Unsettled - Pending		
2018-10-15 11:23:26	Match Status	Matched		
2018-10-15 11:23:25	Match Status	Unmatched		
2018-10-15 11:23:25	Settlement Status	Unsettled - Pending		
2018-10-15 11:23:25	Cancellation Status	Not cancelled		
2018-10-15 11:23:25	Approval Status	Approved		

Illustration 59: Status history - details screen

Field Description

Settlement Instruction - Status History	
Instruction	Shows the reference of the instruction for which the status history is shown. Displayed format is: max. 16 characters (SWIFT-x)
Effective Date and Time	Shows the timestamp when the status query was made. Displayed format is: YYYY-MM-DD hh:mm:ss
Date and Time	Shows the date and time when the status value was modified. Displayed format is: YYYY-MM-DD hh:mm:ss
Status Type	Shows the status type depending on the instruction type from the possible values: <ul style="list-style-type: none"> <input type="checkbox"/> Settlement Status (for settlement instructions and restrictions) <input type="checkbox"/> Match Status (for all types of LCMM instructions) <input type="checkbox"/> Cancellation Status (for all types of LCMM instructions) <input type="checkbox"/> Party Hold (for settlement instructions) <input type="checkbox"/> CSD Hold Status (for settlement instructions) <input type="checkbox"/> CSD Validation Hold Status (for settlement instructions) <input type="checkbox"/> CoSD Hold Status (for settlement instructions) <input type="checkbox"/> Execution Status (for cancellation instructions and condition modification instructions) <input type="checkbox"/> Approval Status (for all types of LCMM instructions)

Settlement Instruction - Status History	
Status Value	Shows the status value of the 'Status Type' field depending on the status type and the instruction type from the possible values: <ul style="list-style-type: none"> <input type="checkbox"/> Match status: 'Matched' or 'Unmatched' <input type="checkbox"/> Cancellation status for settlement instructions and restrictions: 'Cancelled' or 'Not Cancelled' <input type="checkbox"/> Cancellation status for cancellation instructions and condition modification instructions: 'Denied' or 'Not Denied' <input type="checkbox"/> Settlement status: 'Unsettled'- Pending' or 'Unsettled - Failing' or 'Partially Settled'- Pending' or 'Partially Settled' - Failing' or 'Settled' <input type="checkbox"/> CoSD hold status: 'Yes' or 'No' <input type="checkbox"/> Party hold status: 'Yes' or 'No' <input type="checkbox"/> CSD hold status: 'Yes' or 'No' <input type="checkbox"/> CSD validation hold status : 'Yes' or 'No' <input type="checkbox"/> Execution status: 'Executed' or 'Not Executed' <input type="checkbox"/> Approval status: 'Approved' or 'Awaiting for Approval' or 'Revoked'
Settled Settlement Amount	Shows the amount settled in the current status update. This field is only filled for an update in a settlement status.
Settled Settlement Quantity	Shows the quantity settled in the current status update. This field is only filled for an update in a settlement status.

2.2.2.21 Insolvency procedure Settlement Instructions - Search/List Screen

Context of Usage

This screen contains a number of search fields. By inputting the relevant data, you can search for settlement instructions under insolvency situation. The search results will be displayed in a list.

After selecting an entry, you can proceed further by clicking on the buttons below.

This screen will be available for the User in case the Insolvency system parameter is activated.

When exporting the content of this screen, you receive the query result in a csv-file.

This screen is not relevant for CB users.

Screen Access Securities >> Settlement >> Insolvency procedure Settlement Instructions

Privileges To use this screen, you need the following privilege [[▶ 1215](#)]:

- Settlement instruction matched and accepted status query privilege

References **User Instructions Part**

This screen is part of the following business scenario:

- View SF1/SF2 timestamps of Settlement Instructions in case of Insolvency situation [[▶ 774](#)]

Business Functionality Document

This screen corresponds to the following business functions:

- Query instruction (T2S.GUI.SESE.INX.0010)
- Display instruction list (T2S.GUI.SESE.INX.0020)

Screenshot

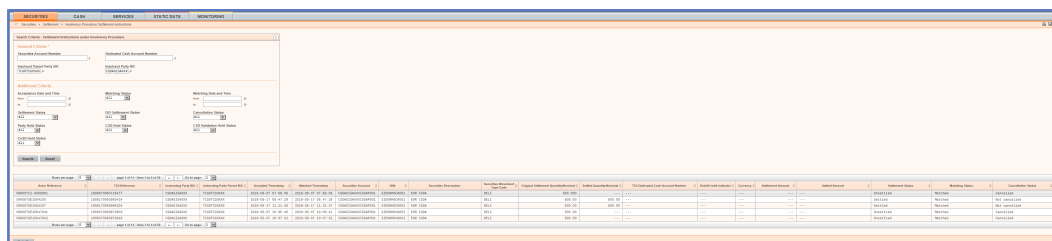

Illustration 60: Insolvency procedure settlement instructions –search/list screen

Field description

Insolvency procedure Settlement Instructions – Search Criteria	
Insolvent Object Criteria*	
Securities Account Number	<p>You can choose to either enter the ‘Securities Account Number’ or to select it from the suggested items in the drop-down menu.</p> <p>Only one of the insolvent object criteria must be filled in: ‘Securities Account Number’, ‘Dedicated Cash Account Number’ or the combination of ‘Insolvent Party BIC’ and ‘Insolvent Parent Party BIC’.</p> <p>In order to query external CSD settlement instructions the search criterion ‘securities account’ must not be filled in.</p> <p>Required format is: max. 35 characters (SWIFT-x)</p> <p>Reference for error message [▶ 1321]:</p> <ul style="list-style-type: none"> <input type="checkbox"/> QMPC030
Dedicated Cash Account Number	<p>You can choose to either enter the ‘Dedicated Cash Account Number’ or to select it from the suggested items in the drop-down menu.</p>

Insolvency procedure Settlement Instructions – Search Criteria	
	<p>Only one of the insolvent object criteria must be filled in: 'Securities Account Number', 'Dedicated Cash Account Number' or the combination of 'Insolvent Party BIC' and 'Insolvent Parent Party BIC'.</p> <p>Required format is: max. 34 characters (SWIFT-x)</p> <p>Reference for error message [▶ 1321]:</p> <ul style="list-style-type: none"> <input type="checkbox"/> QMPC031
Insolvent Party BIC	<p>You can choose to either enter the 'Insolvent Party BIC' or to select it from the suggested items in the drop-down menu.</p> <p>Only one of the insolvent object criteria must be filled: 'Securities Account Number', 'Dedicated Cash Account Number' or the combination of 'Insolvent Party BIC' and 'Insolvent Parent Party BIC'.</p> <p>If the Insolvent Party BIC is filled in, the Insolvent Parent Party BIC needs to be filled in as well.</p> <p>Required format is: max. 11 characters (SWIFT-x)</p> <p>References for error messages [▶ 1321]:</p> <ul style="list-style-type: none"> <input type="checkbox"/> QMPC032 <input type="checkbox"/> QMPC084
Insolvent Parent Party BIC	<p>You can choose to either enter the 'Insolvent Party Parent BIC' or to select it from the suggested items in the drop-down menu.</p> <p>Only one of the insolvent object criteria must be filled in: 'Securities Account Number', 'Dedicated Cash Account Number' or the combination of 'Insolvent Party BIC' and 'Insolvent Parent Party BIC'.</p> <p>If the Insolvent Parent Party BIC is filled in, the Insolvent Party BIC needs to be filled in as well.</p> <p>Required format is: max. 11 characters (SWIFT-x)</p> <p>References for error messages [▶ 1321]:</p> <ul style="list-style-type: none"> <input type="checkbox"/> QMPC048 <input type="checkbox"/> QMPC084
Additional Criteria	

Insolvency procedure Settlement Instructions – Search Criteria	
Acceptance Date and Time – from	<p>Enter the lower bound of the search range for the acceptance date and time (i.e. SF1: moment of acceptance) or use the <i>calendar</i> icon.</p> <p>Required format is: YYYY-MM-DD hh:mm:ss</p> <p>Reference for error message [▶ 1321]:</p> <ul style="list-style-type: none"><input type="checkbox"/> QMPC015 <p>Only Settlement Instructions successfully created in 4-eyes mode (i.e. approval status = approved) will be considered in the query. Settlement Instructions with other approval status value will not be included in the search results.</p>
Acceptance Date and Time – to	<p>Enter the upper bound of the search range for the acceptance date and time (i.e. SF1: moment of acceptance) or use the <i>calendar</i> icon.</p> <p>Required format is: YYYY-MM-DD hh:mm:ss</p> <p>Reference for error message [▶ 1321]:</p> <ul style="list-style-type: none"><input type="checkbox"/> QMPC015 <p>Only Settlement Instructions successfully created in 4-eyes mode (i.e. approval status = approved) will be considered in the query. Settlement Instructions with other approval status value will not be included in the query results.</p>
Matching Status	<p>Select the matching status from the possible values:</p> <ul style="list-style-type: none"><input type="checkbox"/> All (default value)<input type="checkbox"/> Unmatched<input type="checkbox"/> Matched
Matching Date and Time - from	<p>Enter the lower bound of the search range for the matching date and time (i.e. SF2: moment of irrevocability) or use the <i>calendar</i> icon.</p> <p>Required format is: YYYY-MM-DD hh:mm:ss</p> <p>Reference for error message [▶ 1321]:</p> <ul style="list-style-type: none"><input type="checkbox"/> QMPC015
Matching Date and Time - to	<p>Enter the upper bound of the search range for the matching date and time (i.e. SF2: moment of irrevocability) or use the <i>calendar</i> icon.</p>

Insolvency procedure Settlement Instructions – Search Criteria	
	<p>Required format is: YYYY-MM-DD hh:mm:ss</p> <p>Reference for error message [▶ 1321]:</p> <p><input type="checkbox"/> QMPC015</p>
Settlement Status	<p>Select the settlement status from the possible values:</p> <p><input type="checkbox"/> All (default value)</p> <p><input type="checkbox"/> Unsettled</p> <p><input type="checkbox"/> Settled</p> <p><input type="checkbox"/> Partially settled</p>
ISO Settlement status	<p>Select the settlement status of the settlement restriction from the possible values:</p> <p><input type="checkbox"/> All (default value)</p> <p><input type="checkbox"/> Pending</p> <p><input type="checkbox"/> Failing</p> <p>If value 'Settlement Status' field is set to 'Settled' or 'Cancellation Status' field is set to 'Cancelled', this field is disabled.</p>
Cancellation Status	<p>Select the cancellation status from the possible values:</p> <p><input type="checkbox"/> All (default value)</p> <p><input type="checkbox"/> Cancelled</p> <p><input type="checkbox"/> Not cancelled</p>
Party Hold Status	<p>Select the party hold status from the possible values:</p> <p><input type="checkbox"/> All (default value)</p> <p><input type="checkbox"/> On hold</p> <p><input type="checkbox"/> Released</p>
CSD Hold Status	<p>Select the CSD hold status from the possible values:</p> <p><input type="checkbox"/> All (default value)</p> <p><input type="checkbox"/> On hold</p> <p><input type="checkbox"/> Released</p>
CSD Validation Hold Status	<p>Select the CSD validation hold status from the possible values:</p> <p><input type="checkbox"/> All (default value)</p> <p><input type="checkbox"/> On hold</p> <p><input type="checkbox"/> Released</p>

Insolvency procedure Settlement Instructions – Search Criteria	
CoSD Hold status	Select the CoSD hold status from the possible values: <input type="checkbox"/> All (default value) <input type="checkbox"/> On hold <input type="checkbox"/> Released
Insolvency procedure Settlement Instructions - List	
Actor Reference	Shows the reference assigned by the Actor to the settlement instruction.
T2S Reference	Shows the reference assigned by T2S to the settlement instruction.
Instructing Party BIC	Shows the BIC of the instructing party of the settlement instruction.
Instructing Party Parent BIC	Shows the parent BIC of the instructing party of the settlement instruction.
Accepted Timestamp (SF1)	Shows the accepted timestamp of the settlement instruction.
Matched Timestamp (SF2)	Shows the matched timestamp of the settlement instruction. In case the settlement instruction is unmatched no timestamp will be shown.
Securities Account Number	Shows the securities account number to or from which a securities entry is made.
ISIN	Shows the ISIN code of the security.
Securities Description	Shows the description of the security.
Securities Movement Type Code	Shows the securities movement type code from the possible values: <input type="checkbox"/> DELI <input type="checkbox"/> RECE
Original Settlement Quantity/Nominal	Shows the quantity of securities to be settled.
Settled Quantity/Nominal	Shows the settled quantity of the settlement instructions.

Insolvency procedure Settlement Instructions – Search Criteria	
T2S Dedicated Cash Account Number	Shows the T2S dedicated cash account number stated in the settlement instruction or the default T2S dedicated cash account number in case it was not stated in the settlement instruction.
Debit/Credit Indicator	Shows the debit credit indicator related to the cash posting from one of the possible values: <ul style="list-style-type: none"> <input type="checkbox"/> DEBIT <input type="checkbox"/> CREDIT <input type="checkbox"/> Empty In case the settlement instruction does not contain the debit credit information, no value will be shown.
Currency	Shows the currency stated in the settlement instruction.
Settlement Amount	Shows the settlement amount as stated in the settlement instruction. In case the settlement instruction does not contain the Settlement Amount information, no value will be shown.
Settled Amount	Shows the total settled amount.
Settlement Status	Shows the settlement status of the settlement instruction. Possible values: <ul style="list-style-type: none"> <input type="checkbox"/> Unsettled <input type="checkbox"/> Settled <input type="checkbox"/> Partially settled
Matching Status	Shows the matching status of the settlement instruction. Possible values: <ul style="list-style-type: none"> <input type="checkbox"/> Unmatched <input type="checkbox"/> Matched
Cancellation Status	Shows the cancellation status of the settlement instruction. Possible values: <ul style="list-style-type: none"> <input type="checkbox"/> Cancelled <input type="checkbox"/> Not Cancelled

Buttons

Search	This function enables you to start a search according to the criteria entered. The results are displayed in a list on the next screen.
--------	--

	<p>If the search retrieves a single record, the <i>settlement instruction - details</i> screen is displayed (to retrieve the relevant timestamps, the <i>back</i> icon of the <i>settlement instruction - details</i> screen must be used).</p> <p>Next screen:</p> <ul style="list-style-type: none"> <input type="checkbox"/> <i>Insolvency procedure settlement instructions – search/ list</i> screen <input type="checkbox"/> <i>Settlement instruction – details</i> screen [▶ 192] <p>References for error messages [▶ 1321]:</p> <ul style="list-style-type: none"> <input type="checkbox"/> QMPC015 <input type="checkbox"/> QMPC030 <input type="checkbox"/> QMPC031 <input type="checkbox"/> QMPC032 <input type="checkbox"/> QMPC048 <input type="checkbox"/> QMPC084
Reset	<p>This function enables you to set all fields to default value and blanks out all optional fields</p> <p>Next screen:</p> <ul style="list-style-type: none"> <input type="checkbox"/> <i>Insolvency procedure settlement instructions – search/ list</i> screen
Details	<p>This function enables you to display the details of the selected instruction.</p> <p>Next screen:</p> <ul style="list-style-type: none"> <input type="checkbox"/> <i>Settlement Instruction – details</i> screen [▶ 192]

2.2.2.22 Links Preventing Settlement - List Screen

Context of Usage

This screen displays the list of all the linked instructions preventing settlement of the selected instruction with the associated constraints.

You can perform the following action: You can check the data.

Screen Access

- Securities >> Settlement >> Settlement Instructions >> *Settlement instructions – search/list* screen >> Click on the *search* button >> *Settlement instructions – search/list* screen >> Click on the *details* button >> *Settlement instruction - details* screen >> Click on the *Links* button

- Securities >> Settlement >> Intra-Position Movements >> *Intra-position movements – search/list* screen >> Click on the *search* button >> *Intra-position movements – search/list* screen >> Click on the *details* button >> *Intra-position movement - details* screen >> Click on the *Links* button
- Cash >> Settlement >> Intra-Balance Movements >> *Intra-balance movements – search/list* screen >> Click on the *search* button >> *Intra-balance movements – search/list* screen >> Click on the *details* button >> *Intra-balance movement - details* screen >> Click on the *Links* button

Privileges

To use this screen, you need the following privileges:

- Settlement instruction audit trail query
- Intra position movements query
- Intra balance movement audit trail list query

References

User Instructions Part

This screen is part of the following business scenarios:

- View the list of links data preventing settlement of a selected settlement instruction
- View the list of links data preventing settlement of a selected settlement restriction on securities
- View the list of links data preventing settlement of a selected settlement restriction on cash

Business Functionality Document

This screen corresponds to the following business functions:

- Query instruction (T2S.GUI.SESE.INX.0010)
- Display instruction list (T2S.GUI.SESE.INX.0020)

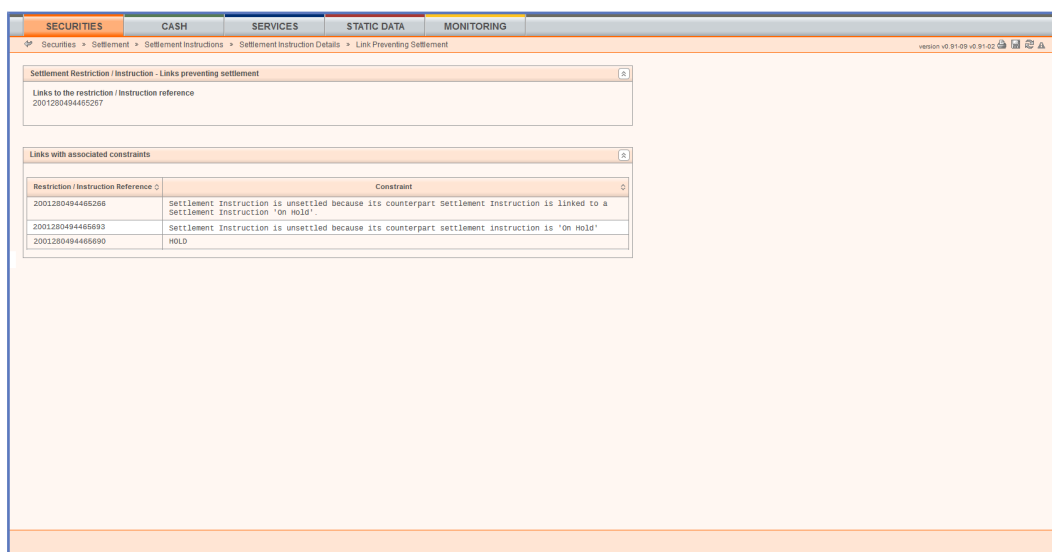

Illustration 61: Links preventing settlement – list screen

Field	Settlement Restriction / Instruction – Links preventing settlement	
Description	Links to the restriction / Instruction reference	Shows the T2S Reference assigned by T2S to the settlement instruction or settlement restriction selected in one of the following screens: <ul style="list-style-type: none"> <input type="checkbox"/> Settlement instruction details <input type="checkbox"/> Intra-Position movement details <input type="checkbox"/> Intra-balance movement details
Links with associated constraints		
	Restriction / Instruction reference	Shows the T2S Reference of the linked settlement restriction or settlement instruction preventing the settlement of the selected settlement instruction or settlement restriction
	Constraint	Lists the constraint applied to the linked settlement instruction or settlement restriction preventing the settlement of the selected settlement instruction or settlement restriction

2.2.2.23 Penalty - Search/List Screen

Context of Usage

This screen contains a number of search fields. By inputting the relevant data, you can search for penalties computed for settlement instructions.

This screen is structured according to the allowed queries.

This screen will only return results where the relevant CSD has the right to access the underlying data (i.e. the penalty is in its data scope).

The search results will be displayed in a list when more than one result is retrieved by T2S. After selecting an entry, you can proceed further by clicking on the buttons below.

When only one result is retrieved, the Penalty – details Screen will be displayed.

When exporting the content of this screen, you receive the query result in a csv-file.

This screen is only available for CSD authorised users and T2S Operator user.

This screen will not be available during the processing of penalties, i.e. between the Events “PMSS” (Penalty Mechanism- Stop Screens and penalty modification requests) and “PMRR” (Penalty Mechanism- Restart GUI and Restart processing penalty modification requests).

- Screen Access**
- Securities >> Settlement >> Daily Penalties
 - Securities >> Settlement >> Settlement Instructions >> *Settlement instructions – search/list* screen >> Click on the *search* button >> *Settlement instructions – search/list* screen >> Click on the *details* button >> *Settlement Instruction – details* screen >> Click on the *associated penalties* button
- Privileges**
- To use this screen, you need the following privilege:
- Penalty List Query Privilege
 - Settlement Instruction Audit Trail Query
- References**
- User Instructions Part**
- This screen is part of the following business scenarios:
- View the individual penalty details
 - View list of penalties

Screenshot

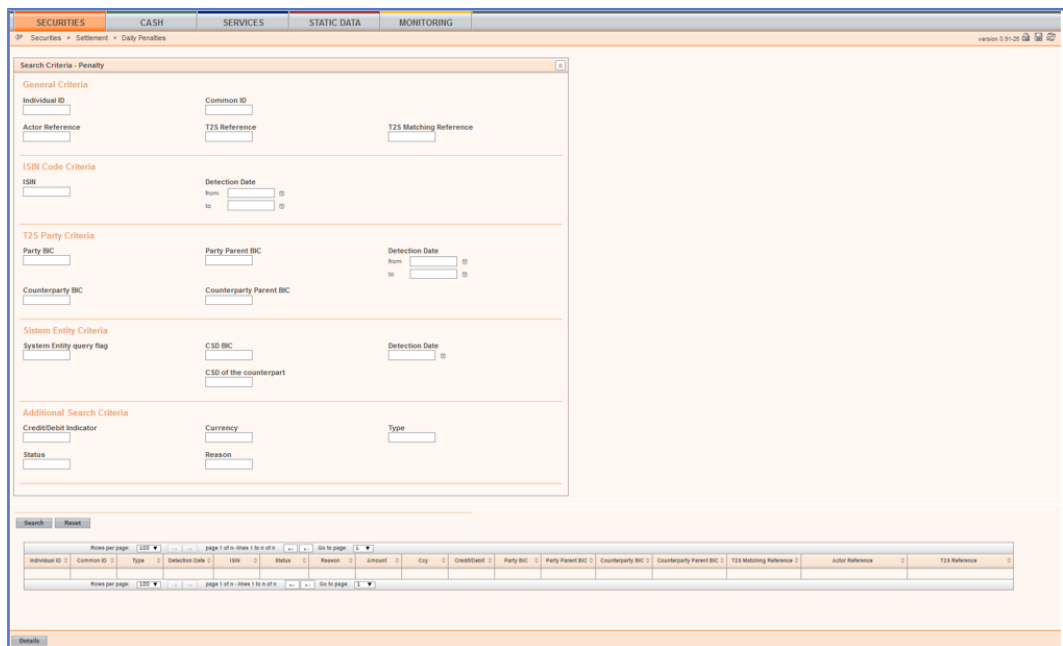

Illustration 62: Penalty – search/list screen

Field Description

Penalty – Search Criteria	
General Criteria	
Individual ID	Enter the individual unique reference assigned to the penalty by T2S for the relevant party. A given penalty can be identified by its individual unique reference assigned by T2S for either the failing or the non-failing party.

Penalty – Search Criteria	
	<p>At least one of the reference parameters needs to be specified to perform this query with a reference.</p> <p>This parameter cannot be combined with parameters of any other queries (i.e. parameters in other Groups).</p> <p>Specifying this parameter will return the Penalty - details screen.</p> <p>Required format is: max. 16 characters (SWIFT-x) , no wildcards allowed.</p>
Common ID	<p>Enter the common reference assigned to the penalty by T2S.</p> <p>A given penalty can be identified by its common reference assigned by T2S for both the failing and the non-failing party.</p> <p>At least one of the reference parameters needs to be specified to perform this query with a reference.</p> <p>This parameter cannot be combined with parameters of any other queries (i.e. parameters in other Groups).</p> <p>Specifying this parameter will return the Penalty - details screen if only a single penalty is retrieved (because only one of the two individual penalties is under the data scope of the CSD). Otherwise, the screen will return the relevant list of penalties (i.e. two penalties, the penalty as reported for the failing party and the penalty as reported to the non-failing party).</p> <p>Required format is: max. 16 characters (SWIFT-x), no wildcards allowed</p>
Actor Reference	<p>Enter the identification of the settlement instruction assigned by the T2S Actor.</p>

Penalty – Search Criteria	
	<p>Penalties can be identified by the T2S Actor Reference of the underlying settlement instruction.</p> <p>At least one of the reference parameters needs to be specified to perform this query.</p> <p>This parameter cannot be combined with parameters of any other queries (i.e. parameters in other Groups).</p> <p>Specifying this parameter will return the Penalty - details screen if only a single penalty is found, otherwise it will return the relevant list of penalties.</p> <p>Required format is: max. 16 characters (SWIFT-x), no wildcards allowed</p>
T2S Reference	<p>Enter the identification assigned by T2S to the settlement instruction.</p> <p>Penalties can be identified by the T2S Reference of the underlying settlement instruction.</p> <p>At least one of the reference parameters needs to be specified to perform this query.</p> <p>This parameter cannot be combined with parameters of any other queries (i.e. parameters in other Groups).</p> <p>Specifying this parameter will return the Penalty - details screen if only a single penalty is found, otherwise it will return the relevant list of penalties.</p> <p>Required format is: max. 16 characters (SWIFT-x), no wildcards allowed</p>
T2S Matching Reference	<p>Enter the settlement instruction matching identification assigned by T2S.</p> <p>Penalties can be identified by the T2S Matching Reference of the underlying settlement instruction.</p>

Penalty – Search Criteria	
	<p>At least one of the reference parameters needs to be specified to perform this query.</p> <p>This parameter cannot be combined with parameters of any other queries (i.e. parameters in other Groups).</p> <p>Specifying this parameter will return the Penalty - details screen if only a single penalty is found, otherwise it will return the relevant list of penalties.</p> <p>Required format is: max. 16 characters (SWIFT-x), no wildcards allowed</p>
ISIN Code Criteria	
ISIN	<p>Enter the ISIN of the security relevant for the penalty.</p> <p>This query parameter is mandatory for queries by ISIN Code Criteria.</p> <p>The ISIN must exist in T2S.</p> <p>Required format is: 12 characters (SWIFT-x).</p>
Detection Date (Date from or equal/ Date to)	<p>Enter the specific business day on which the penalty was detected or use the <i>calendar</i> icon.</p> <p>In order to search for a period, enter the lower and the upper bound of the search range for the business day for which the penalty was initially detected or use the calendar icon.</p> <p>Note: This date is not updated upon recalculation of the penalty and always relates to the business day for which the penalty was initially detected.</p> <p>This query parameter is mandatory for queries by ISIN Code Criteria.</p> <p>Required format is: YYYY-MM-DD</p>
T2S Party Criteria	

Penalty – Search Criteria	
Party BIC	<p>You can choose to either enter the 'Party BIC' or to select it from the suggested items in the drop-down menu.</p> <p>The selected BIC corresponds to the party imposed with or entitled to receive the penalty(ies) retrieved by the query.</p> <p>This query parameter is mandatory for queries by T2S Party Criteria.</p> <p>Required format is: max. 11 characters (SWIFT-x)</p>
Party Parent BIC	<p>This parameter is mandatory when Party BIC is fulfilled.</p> <p>Field is empty by default. You can select the 'Party Parent BIC' from the suggested items in the drop-down menu, which displays the following values to be input:</p> <ul style="list-style-type: none"><input type="checkbox"/> The BIC of the CSD<input type="checkbox"/> T2S BIC <p>Note: In order to determine the data scope of the query, T2S automatically considers the CSD associated to the user performing the query. Hence, the parameter 'Party Parent BIC' is only relevant to query those penalties where the CSD itself is reported as failing or non-failing party (for which case, the user needs to input the T2S BIC)</p> <p>Required format is: max. 11 characters (SWIFT-x).</p>
Detection Date (Date from or equal/ Date to)	<p>Enter the specific business day for which the penalty was detected or use the <i>calendar</i> icon.</p> <p>In order to search for a period, enter the lower and upper bound of the search range for the business day for which the penalty was initially detected or use the <i>calendar</i> icon.</p>

Penalty – Search Criteria	
	<p>Note: This date is not updated upon recalculation of the penalty and always relates to the business day for which the penalty was initially detected.</p> <p>This query parameter is mandatory for queries by T2S Party Criteria.</p> <p>Required format is: YYYY-MM-DD</p>
Counterparty BIC	<p>You can choose to either enter the 'Counterparty BIC' or to select it from the suggested items in the drop-down menu.</p> <p>The selected BIC corresponds to the counterparty entitled to receive or imposed with the penalty(ies) retrieved by the query.</p> <p>This parameter can be used as search criteria only if the Party BIC is provided.</p> <p>Required format is: max. 11 characters (SWIFT-x)</p>
Counterparty Parent BIC	<p>You can select the 'Counterparty Parent BIC' from the suggested items in the drop-down menu.</p> <p>The selected BIC corresponds to the parent of the counterparty entitled to receive or imposed with the penalty(ies) retrieved by the query.</p> <p>This parameter is mandatory when Counterparty BIC is fulfilled.</p> <p>Field is empty by default, displays the following values to be input:</p> <ul style="list-style-type: none"> <input type="checkbox"/> The BICs of all CSD and the T2S BIC. <p>Required format is: max. 11 characters (SWIFT-x).</p>
System Entity Criteria	

Penalty – Search Criteria	
System Entity query flag	<p>Select if the query desired is a System Entity wide Penalty Query from the possible values:</p> <ul style="list-style-type: none"><input type="checkbox"/> Yes<input type="checkbox"/> No (default value) <p>This parameter is mandatory for queries by System Entity Criteria.</p>
CSD BIC	<p>Select the BIC of the CSD whose Participants are imposed with or entitled to receive the penalties retrieved by the query.</p> <p>This parameter is mandatory for queries by System Entity Criteria.</p> <p>If the System Entity query flag = NO, this field is not available.</p> <p>If the System Entity query flag = YES, this field is mandatory and displays the following value:</p> <ul style="list-style-type: none"><input type="checkbox"/> CSD BIC <p>Required format is: max. 11 characters (SWIFT-x)</p>
Detection Date	<p>Enter the specific business day for which the penalty was detected or use the <i>calendar</i> icon.</p> <p>Note: This date is not updated upon recalculation of the penalty and always relates to the business day for which the penalty was initially detected.</p> <p>This parameter is mandatory for queries by System Entity Criteria.</p> <p>If the System Entity query flag = NO, this field is not available.</p> <p>If the System Entity query flag = YES, this field is mandatory</p> <p>Required format is: YYYY-MM-DD</p>

Penalty – Search Criteria	
CSD of the counterpart	<p>Select the BIC of the CSD of the counterparty of the penalty</p> <p>If the System Entity query flag = NO, this field is not available.</p> <p>If the System Entity query flag = YES, this field displays the following values:</p> <ul style="list-style-type: none"><input type="checkbox"/> All (default value)<input type="checkbox"/> The BICs of all CSDs <p>Required format is: max. 11 characters (SWIFT-x)</p>
Additional Search Criteria (Use to limit query results of ISIN Code, T2S Party and System Entity Search Criteria)	
Credit/Debit Indicator	<p>Select the Party Credit/Debit Code identifying the party as non-failing or failing from the possible values:</p> <ul style="list-style-type: none"><input type="checkbox"/> All (default value)<input type="checkbox"/> DBIT (Debit)<input type="checkbox"/> CRDT (Credit) <p>Required format is: 4 characters (SWIFT-x)</p>
Currency	<p>Enter the relevant T2S currency of the penalty or use the drop-down menu</p> <p>Possible values:</p> <ul style="list-style-type: none"><input type="checkbox"/> 'All' (default value)<input type="checkbox"/> Reference Data Settlement Currencies <p>Required format is: 3 characters (SWIFT-x)</p>
Type	<p>Select the type of penalty from the possible values:</p> <ul style="list-style-type: none"><input type="checkbox"/> All (default value)<input type="checkbox"/> SEFP (Settlement Fail Penalty)<input type="checkbox"/> LMFP (Late Match Fail Penalty)

Penalty – Search Criteria	
	Required format is: 4 characters (SWIFT-x)
Status	<p>Select the status of the penalty from the possible values:</p> <ul style="list-style-type: none"><input type="checkbox"/> All (default value)<input type="checkbox"/> ACTV (Active)<input type="checkbox"/> REMO (Removed)<input type="checkbox"/> NCOM (Not computed) <p>Required format is: 4 characters (SWIFT-x)</p>
Reason	<p>Select the reason of the penalty status from the possible values:</p> <ul style="list-style-type: none"><input type="checkbox"/> All (default value)<input type="checkbox"/> UPDT (updated)<input type="checkbox"/> NEWP (New penalty resulting from the insertion of a Security Subject to Penalties with Valid From in the past, or from a contingency scenario)<input type="checkbox"/> RALO (re-allocated)<input type="checkbox"/> SWIC (switched)<input type="checkbox"/> INSO (removed due to insolvency)<input type="checkbox"/> SESU (removed due to ISIN suspension from SETT)<input type="checkbox"/> SUSP (removed due to ISIN suspension from trading)<input type="checkbox"/> SEMP (removed due to settlement on multiple platforms)<input type="checkbox"/> TECH (removed due to technical impossibilities that prevent settlement)<input type="checkbox"/> OTHR (removed due to another reason) <p>Required format is: 4 characters (SWIFT-x)</p>

Penalty – Search Criteria	
Penalty - List	
Individual ID	Shows the individual unique reference assigned to the penalty by T2S.
Common ID	Shows the common reference assigned to the penalty by T2S, which is common for both the failing and the non-failing participant.
Type	Shows the type of penalty from the possible values: <ul style="list-style-type: none"><input type="checkbox"/> SEFP (Settlement Fail Penalty)<input type="checkbox"/> LMFP (Late Match Fail Penalty)
Detection Date	Shows the Business day when the penalty was detected.
ISIN	Shows the ISIN of the security used for the penalty calculation.
Status	Shows the status of the penalty from the possible values: <ul style="list-style-type: none"><input type="checkbox"/> ACTV (Active)<input type="checkbox"/> REMO (Removed)<input type="checkbox"/> NCOM (Not computed)
Reason	Shows the reason of the penalty status from the possible values: <ul style="list-style-type: none"><input type="checkbox"/> Empty (default value)<input type="checkbox"/> UPDT (updated)<input type="checkbox"/> NEWP (New penalty resulting from the insertion of a Security Subject to Penalties with Valid From in the past, or from a contingency scenario)<input type="checkbox"/> RALO (re-allocated)<input type="checkbox"/> SWIC (switched)<input type="checkbox"/> INSO (removed due to insolvency)<input type="checkbox"/> SESU (removed due to ISIN suspension from SETT)

Penalty – Search Criteria	
	<ul style="list-style-type: none"><input type="checkbox"/> SUSP (removed due to ISIN suspension from trading)<input type="checkbox"/> SEMP (removed due to settlement on multiple platforms)<input type="checkbox"/> TECH (removed due to technical impossibilities that prevent settlement)<input type="checkbox"/> OTHR (removed due to another reason)
Amount	Shows the amount of the penalty.
Ccy	Shows the T2S relevant currency of the amount of the penalty.
Credit/Debit	Shows the Party Credit/Debit Code identifying the party as non-failing or failing.
Party BIC	Shows the BIC of the Party imposed with or entitled to receive the penalties retrieved by the query.
Party Parent BIC	Shows the BIC of the Parent Party imposed with or entitled to receive the penalties retrieved by the query.
Counterparty BIC	Shows the BIC of the counterparty entitled to receive or imposed with the amount retrieved by the query.
Counterparty Parent BIC	Shows the BIC of the parent of the counterparty entitled to receive or imposed with the amount retrieved by the query.
T2S Matching Reference	Shows the matching identification code assigned by T2S to the related settlement instruction.
Actor Reference	Shows the identification assigned by the T2S Actor to the related settlement instruction.
T2S Reference	Shows the instruction identification code assigned by T2S to the related settlement instruction.

Note: the above order is the default one provided by T2S as a result of the query. Nevertheless, once the list is displayed in the screen it should be allowed for the user to reorganise the order of the columns in the screen (although in case it is exported, the list is displayed in the original order).

Buttons

Buttons	
Search	<p>This function enables you to start a search according to the criteria entered. The results are displayed in a list on the next screen, if the search retrieves several records.</p> <p>If the search retrieves a single record, the Penalty - details screen is displayed.</p> <p>Next screens:</p> <ul style="list-style-type: none"> <input type="checkbox"/> Penalty - Search/List Screen [▶ 279] <input type="checkbox"/> Penalty - Details Screen [▶ 291]
Reset	<p>This function enables you to set all fields to default value and blanks out all optional fields.</p> <p>Next screen:</p> <ul style="list-style-type: none"> <input type="checkbox"/> Penalty - Search/List Screen [▶ 279]
Details	<p>This function enables you to display the details of the selected penalty.</p> <p>Next screen:</p> <ul style="list-style-type: none"> <input type="checkbox"/> Penalty - Details Screen [▶ 291]

2.2.2.24 Penalty - Details Screen

Context of Usage

This screen displays detailed information on the selected penalty. You can check the data and proceed further by clicking the buttons below.

You can perform the following foreseen actions: check the specific details of a penalty, remove it, re-include it, re-allocate it, switch it, see its revisions/audit trail, and access the details of the underlying settlement instruction.

When exporting the content of this screen, you receive the query result in a csv-file.

This screen is only available for CSD authorised users and T2S Operator user.

This screen will not be available during the processing of penalties, i.e. between the Events “PMSS” (Penalty Mechanism- Stop Screens and penalty modification requests) and “PMRR” (Penalty Mechanism- Restart GUI and Restart processing penalty modification requests).

Screen Access

- Securities >> Settlement >> Daily Penalties >> Penalty – search/list screen >> Click on the search button
- Securities >> Settlement >> Daily Penalties >> Penalty – search/list screen >> Click on the search button >> Penalty – search/list screen >> Click on the details button
- Securities >> Settlement >> Settlement Instruction >> Settlement instructions – search/list screen >> Click on the search and/or details button >> Settlement Instruction – details screen >> Click on the associated penalties button

Privileges

To use this screen, you need the following privilege:

- Penalty Details Query Privilege
- Settlement Instruction Audit Trail Query References

References**User Instructions Part**

This screen is part of the following business scenarios:

- View the individual penalty details
- Modification of existing penalties
- View settlement instruction details

Screenshot

SECURITIES	CASH	SERVICES	STATIC DATA	MONITORING
<p>Securities > Settlement > Daily Penalties > Penalty Details</p>				
<p>Penalty</p>				
<p>General Details</p>				
Individual ID F20030300000007	Common ID 200303000000007	Re-allocated to/from penalty ---		
Party BIC PARBESDPXXX	Party Parent BIC CSDYESDPXXX	Credit/Debit Indicator DBIT		
Counterparty BIC CSDYESDPXXX	Counterparty Parent BIC CSDYESDPXXX			
Type SEFP	Detection Date 2020-02-28	In Appeal Period NO		
Amount of the penalty ---	To be recalculated NO			
Status NCOM	Reason ---	Description ---		
Number of Days 1	Calculation Method CASH			
<p>Calculation Details</p>				
Date Fri Feb 28 00:00:00 CET 2020				
Security Subject to Penalties FALSE	Cannot be calculated ---			
Financial Instrument Type ---	Liquidity ---			
Place of Trade Market Identifier Code ---	SME Growth Market ---	Security Penalty Rate ---		
Original Currency ---	Euro Foreign Exchange ---	EURDKK FX (for pivot) ---		
Sub-amount Securities ---	Cash Discount Penalty Rate ---	Sub-amount Cash ---		
<p>Related Settlement Instruction Details</p>				
Actor Reference C654-ALM-150DAF	Reference owner BIC PARBESDPXXX	Reference owner Parent BIC CSDYESDPXXX		
T2S Reference 2002190494852167	T2S Matching Reference 0120059917921000			
Common Reference C654-ALM-150F	Corporate Action Event Identification ---			
Intended Settlement Date 2020-02-20	Securities Transaction Type NSYN	Already Matched Flag NO		
Securities Movement Type Delivery	ISIN ESES DP200378	Quantity ---		
Securities Account Number PARBESDPXXXCSDP0001	Account Owner BIC ---	BIC of the Depository ---		
Settlement Type Units				
Payment Type Code APMT	Credit/Debit CRDT	Amount 1		
Dedicated Cash Account Number PMBAESDMXXXEURDCA0004	DCA Owner BIC ---			
Accepted Timestamp 2020-02-19 12:28:12.072	Matched Timestamp 2020-02-19 12:32:40.608	Failed Reason BLOC SXAA002 Settlement Instruction is not settled because of an intraday restriction on the cash account used by the counterparty ELOC SXAA003 Settlement Instruction is not settled because of an intraday restriction on the securities account used		
Cut-off IDVP	Cut-off Start TS 2020-03-02 19:21:52.125	Cut-off End TS 2020-03-02 19:24:30.432		
<p>Removal Re-include Re-allocate Switch Revisions SI Details</p>				

Illustration 63: Penalty - Details Screen UHB

Field Description

Penalty Details	
General Details	
Individual ID	Shows the individual unique reference assigned to the penalty by T2S.

Penalty Details	
	<p>A given penalty can be identified by its individual unique reference assigned by T2S for either the failing or the non-failing party.</p>
Common ID	<p>Shows the common reference assigned to the penalty by T2S.</p> <p>A given penalty can be identified by its common reference assigned by T2S for both the failing and the non-failing party.</p>
Re-allocated to/from penalty	<p>Shows the Common ID of the penalty re-allocated to/from the penalty retrieved by the query.</p> <p>It will be updated with the new/old Common Id after a re-allocation execution.</p>
Party BIC	<p>Shows the BIC of the Party imposed with or entitled to receive the penalty retrieved by the query.</p> <p>The party is the failing or the non-failing party depending on the direction of the penalty.</p>
Party Parent BIC	<p>Shows the BIC of the Parent Party imposed with or entitled to receive the penalty retrieved by the query.</p>
Credit/Debit Indicator	<p>Shows the Party Credit/Debit Code identifying the party as non-failing or failing from the possible values:</p> <ul style="list-style-type: none"><input type="checkbox"/> CRDT (Credit)<input type="checkbox"/> DBIT (Debit)
Counterparty BIC	<p>Shows the BIC of the counterparty of the party imposed with or entitled to receive the penalty retrieved by the query.</p> <p>The Counterparty is the failing or the non-failing party depending on the direction of the penalty.</p>

Penalty Details	
Counterparty Parent BIC	Shows the BIC of the parent of the counterparty imposed with or entitled to receive the penalty retrieved by the query.
Type	Shows the type of penalty from the possible values: <input type="checkbox"/> SEFP (Settlement Fail Penalty) <input type="checkbox"/> LMFP (Late Match Fail Penalty)
Detection Date	Shows the business day when the penalty was detected. I.e. <input type="checkbox"/> The date on which the instruction matched for LMFPs. <input type="checkbox"/> The date on which an instruction failed to settle in T2S for SEFPs. This date is not updated upon re-calculation of the penalty.
In appeal period	Shows if the penalty is within its appeal period. Possible values: <input type="checkbox"/> YES <input type="checkbox"/> NO
Amount of the penalty	Shows the amount of the penalty with its T2S relevant currency.
To be recalculated	Shows if the penalty is pending to be re-calculated after being modified. Possible values: <input type="checkbox"/> YES <input type="checkbox"/> NO
Status	Shows the status of the penalty from the possible values: <input type="checkbox"/> ACTV (Active) <input type="checkbox"/> REMO (Removed) <input type="checkbox"/> NCOM (Not computed)

Penalty Details	
	Note: If the status of the penalty is REMO, the attributes of "Calculation Details" are not visible.
Reason	<p>Shows the reason of the penalty status from the possible values:</p> <ul style="list-style-type: none"><input type="checkbox"/> Empty (default value, for new penalties)<input type="checkbox"/> UPDT (updated)<input type="checkbox"/> NEWP (New penalty resulting from the insertion of a Security Subject to Penalties with Valid From in the past, or from a contingency scenario)<input type="checkbox"/> RALO (re-allocated)<input type="checkbox"/> SWIC (switched)<input type="checkbox"/> INSO (removed due to insolvency)<input type="checkbox"/> SESU (removed due to ISIN suspension from SETT)<input type="checkbox"/> SUSP (removed due to ISIN suspension from trading)<input type="checkbox"/> SEMP (removed due to settlement on multiple platforms)<input type="checkbox"/> TECH (removed due to technical impossibilities that prevent settlement)<input type="checkbox"/> OTHR (removed due to another reason)
Description	Shows the reason for the removal (when the status of the penalty is 'Removed' and the reason is 'OTHR') and for the switch (when the status of the penalty is 'Active' and the reason is 'SWIC') as provided by the CSD when the penalty modification was requested.
Number of Days	The value is 1 always in case of 'SEFP'.

Penalty Details	
	Shows the number of business days used for the calculation of the penalty in case of 'LMFP'.
Calculation Method	<p>Shows the calculation rule used to compute the penalty from the possible values:</p> <ul style="list-style-type: none"> <input type="checkbox"/> SECU (The penalty is based on the quantity of securities failed to be delivered and penalty rate of the relevant asset type). <input type="checkbox"/> MIXE (The penalty is based on the quantity of securities failed to be delivered and penalty rate is the discount rate of the relevant currency). <input type="checkbox"/> CASH (The penalty is based on the amount of cash failed to be delivered and the penalty rate is the discount rate of the relevant currency). <input type="checkbox"/> BOTH (The penalty is the sum of SECU and CASH).
<p>Calculation Details</p> <p>Block with the details for any of the applicable Business Days considered in the computation of the penalty</p> <p>The block is not shown in case the penalty is Removed.</p>	
Date	<p>Shows the Business Day for the data provided in this block.</p> <p>When "Number of Days" = 1 this field will be displayed as a text (i.e. the date of the penalty is displayed)</p> <p>When "Number of Days">1 it will display a list with all the applicable Business Days (i.e. when there is a sub-amount).</p>

Penalty Details	
	<p>The order of the list will be descending (i.e. first value of the list will be the Closest Business Day to the current Business day).</p> <p>Limit: The user can only select (to see the Calculation Details) dates within the last 3 months. Former days (before 3 months) have the same Calculation Details than the ones for the Date equal to 3 months ago.</p>
Security Subject to Penalties	<p>Shows if the security is subject to penalties on the business day. Possible values:</p> <ul style="list-style-type: none"> <input type="checkbox"/> TRUE (default) <input type="checkbox"/> FALSE <p>It will be shown the information corresponding to the date chosen in the field DATE.</p> <p>If no value is retrieved, it will show "---"</p>
Cannot be calculated	<p>This information is only provided for penalties where there is missing or diverging reference data needed for the penalty calculation.</p> <p>Possible values:</p> <ul style="list-style-type: none"> <input type="checkbox"/> Empty (default). If value is FALSE in the data base or if no value is retrieved, it will show empty ("---") <input type="checkbox"/> TRUE
Reason for not calculation	<p>Shows the reason why the Penalty cannot be calculated.</p> <p>Only shown if the Cannot be calculated field is TRUE.</p>
Financial Instrument Type	<p>Shows the type of the financial instrument from the possible values:</p> <ul style="list-style-type: none"> <input type="checkbox"/> SHRS <input type="checkbox"/> SOVR

Penalty Details	
	<ul style="list-style-type: none"> <input type="checkbox"/> DEBT <input type="checkbox"/> SECU <input type="checkbox"/> ETFS <input type="checkbox"/> UCIT <input type="checkbox"/> MMKT <input type="checkbox"/> EMAL <input type="checkbox"/> OTHR <p>It will be shown the information corresponding to the date chosen in the field DATE.</p> <p>If no value is retrieved, it will show "---"</p>
Liquidity	<p>Shows the binary classification of securities applying for shares.</p> <p>It will show the information corresponding to the date chosen in the field DATE.</p> <p>Possible values:</p> <ul style="list-style-type: none"> <input type="checkbox"/> Empty ("---") <input type="checkbox"/> TRUE <input type="checkbox"/> FALSE <p>Informed only if:</p> <ul style="list-style-type: none"> <input type="checkbox"/> The Security is Subject to penalties <input type="checkbox"/> The Financial Instrument Type of the security (Classification type) is "SHRS", and <input type="checkbox"/> The Calculation method code is "SECU" or "BOTH". <p>Otherwise it is empty.</p> <p>If no value is retrieved, it will also show "---"</p>
Place of Trade Market Identifier Code	<p>Shows the Market identifier Code when it was informed equally in the Place of Trade of the two matched Settlement Instructions. If it was not informed equally, the field will be empty.</p>

Penalty Details	
	If no value is retrieved, it will show "---"
SME Growth Market	<p>Shows if the Place of Trade (MIC) is in the list of recognised SME Growth Markets Trading Venues.</p> <p>It will show the information corresponding to the date chosen in the field DATE.</p> <ul style="list-style-type: none"><input type="checkbox"/> Possible values:<input type="checkbox"/> Empty ("---")<input type="checkbox"/> TRUE<input type="checkbox"/> FALSE <p>Informed only if:</p> <ul style="list-style-type: none"><input type="checkbox"/> The Security is Subject to penalties<input type="checkbox"/> The Financial Instrument Type of the security (Classification type) is different from "SOVR", and<input type="checkbox"/> The Calculation method code is "SECU" or "BOTH". <p>Otherwise it is empty.</p> <p>If no value is retrieved, it will also show "---"</p>
Security Penalty Rate	<p>Shows the security penalty rate that based on the asset type was used for the calculation of the penalty.</p> <p>It will show the information corresponding to the date chosen in the field DATE.</p> <p>Informed when the calculation method is "SECU" or "BOTH". Otherwise it is empty.</p> <p>If no value is retrieved, it will show "---"</p>
Original Currency	<p>Shows the currency of the reference price (i.e. when the security is in Unit) or of the reference security (i.e when the security is in FAMT) of the Settlement Instruction.</p>

Penalty Details	
	<p>It will show the information corresponding to the date chosen in the field DATE.</p> <p>If no value is retrieved, it will show "---"</p>
Euro Foreign Exchange	<p>Shows the Euro Foreign Exchange unit and currency used for the computation of the penalty, when necessary.</p> <p>It will show the information corresponding to the date chosen in the field DATE.</p> <p>If no value is retrieved, it will show "---"</p>
EURDKK FX (for pivot)	<p>Shows the second Euro Foreign Exchange unit and currency used as pivot for the computation of the penalty, when necessary.</p> <p>It will show the information corresponding to the date chosen in the field DATE.</p> <p>If no value is retrieved, it will show "---"</p>
Sub-amount Securities	<p>Shows the amount of the penalty for this business day and its T2S relevant currency.</p> <p>It is only provided if the number of days is higher than one (i.e. when it is a LMFP and the block calculation details has more than one instance) or if the calculation method is BOTH (in this case Sub-amount cash is also provided).</p> <p>It will show the information corresponding to the date chosen in the field DATE.</p> <p>If no value is retrieved, it will show "---"</p>
Cash Discount Penalty Rate	<p>Shows the currency discount penalty rate used for the computation of the penalty.</p>

Penalty Details	
	<p>Informed when the calculation method is MIXE, CASH or BOTH. Otherwise it is empty.</p> <p>It will show the information corresponding to the date chosen in the field DATE.</p> <p>If no value is retrieved, it will show "---"</p>
Sub-amount Cash	<p>Shows the amount of the penalty for this business day and its T2S relevant currency.</p> <p>It is only provided if the number of days is higher than one (i.e. when it is a LMFP and the block calculation details has more than one instance) or if the calculation method is BOTH (in this case also Sub-amount securities is provided).</p> <p>It will show the information corresponding to the date chosen in the field DATE.</p> <p>If no value is retrieved, it will show "---"</p>
Related Settlement Instruction Details	
Actor Reference	Shows the identification assigned by the T2S Actor to the related settlement instruction.
Reference Owner BIC	Shows the BIC of the Instructing Party of the settlement instruction.
Reference Owner Parent BIC	Shows the Parent BIC of the Instructing Party of the settlement instruction.
T2S Reference	Shows the instruction identification code assigned by T2S to the related settlement instruction.
T2S Matching Reference	Shows the matching identification code assigned by T2S to the related settlement instruction.

Penalty Details	
Common Reference	Shows the reference provided by the T2S Actor when the LCMM Instruction is already matched or in order to facilitate the matching within T2S.
Corporate Action Event Id	Shows the identification assigned by the account servicer to unambiguously identify a corporate action event.
Intended Settlement Date	Shows the date when the settlement instruction becomes eligible to be submitted to settlement. Displayed format is: YYYY-MM-DD
Securities Transaction Type	Shows the securities transaction type expressed as an ISO 20022 code from the possible values: <ul style="list-style-type: none"><input type="checkbox"/> AUTO (for auto-collateralisation)<input type="checkbox"/> BSBK (for buy sell back)<input type="checkbox"/> BYIY (for buy-in)<input type="checkbox"/> CLAI (for market claim)<input type="checkbox"/> CNCB (for central bank collateral operation)<input type="checkbox"/> COLI (for collateral in)<input type="checkbox"/> COLO (for collateral out)<input type="checkbox"/> CONV (for depository receipt conversion)<input type="checkbox"/> CORP (for corporate action)<input type="checkbox"/> ETFT (for exchange traded funds)<input type="checkbox"/> FCTA (for factor update)<input type="checkbox"/> INSP (for move of stock)<input type="checkbox"/> ISSU (for depository receipt issue)<input type="checkbox"/> MKDW (for mark down)<input type="checkbox"/> MKUP (for mark up)<input type="checkbox"/> NETT (for netting)<input type="checkbox"/> NSYN (for non syndicated)<input type="checkbox"/> OWNE (for external account transfer)

Penalty Details	
	<ul style="list-style-type: none"><input type="checkbox"/> OWNI (for internal account transfer)<input type="checkbox"/> PAIR (for pair off)<input type="checkbox"/> PLAC (for placement)<input type="checkbox"/> PORT (for portfolio move)<input type="checkbox"/> REAL (for realignment)<input type="checkbox"/> REBL (Rebalancing)<input type="checkbox"/> REDI (for withdrawal)<input type="checkbox"/> REDM (for redemption)<input type="checkbox"/> RELE (for depository receipt release cancellation)<input type="checkbox"/> REPU (for repo)<input type="checkbox"/> RODE (for return delivery without matching)<input type="checkbox"/> RVPO (for reverse repo)<input type="checkbox"/> SBBK (for sell buy back)<input type="checkbox"/> SBRE (for borrowing reallocation)<input type="checkbox"/> SECB (for securities borrowing)<input type="checkbox"/> SECL (for securities lending)<input type="checkbox"/> SLRE (for lending reallocation)<input type="checkbox"/> SUBS (for subscription)<input type="checkbox"/> SWIF (Switch From)<input type="checkbox"/> SWIT (Switch To)<input type="checkbox"/> SYND (for syndicate underwriters)<input type="checkbox"/> TBAC (for TBA closing)<input type="checkbox"/> TRAD (for trade)<input type="checkbox"/> TRPO (for triparty repo)<input type="checkbox"/> TRVO (for triparty reverse repo)<input type="checkbox"/> TURN (for turnaround)
Already Matched Flag	<p>Shows if the settlement instruction was sent as already matched to T2S or not (for LMFP). Possible values:</p> <ul style="list-style-type: none"><input type="checkbox"/> YES<input type="checkbox"/> NO

Penalty Details	
Securities Movement Type	Shows if the movement on a securities account results from a deliver or a receive instruction from the possible values: <input type="checkbox"/> DELI (for deliver) <input type="checkbox"/> RECE (for receive)
ISIN	Shows the ISIN code of the security.
Quantity	Shows the remaining quantity of the underlying Settlement Instruction used for the calculation of the SEFP. Shows the matched quantity of the underlying Settlement Instruction used for the calculation of the LMFP
Securities Account Number	Shows the account to or from which a securities entry is made.
Account Owner BIC	Shows the BIC of the Securities Account owner.
BIC of the Depository	Shows the BIC of the CSD of the Securities Account Owner. It is filled only in case of LMFP. Otherwise, it will show "---".
Settlement Type	Shows the type of settlement foreseen for the security, stated in the instruction. Possible values: <input type="checkbox"/> Units <input type="checkbox"/> Face Amount
Payment Type Code	Shows if the transaction is to be settled with or without payment from the possible values: <input type="checkbox"/> APMT (for 'Against Payment Settlement') <input type="checkbox"/> FREE (for 'Separate Settlement')

Penalty Details	
Credit/Debit	Shows if the original settlement amount is to be credited or debited. from the possible values: <input type="checkbox"/> DBIT (Debit) <input type="checkbox"/> CRDT (Credit)
Amount	Shows the remaining amount of the underlying Settlement Instruction used for the calculation of the SEFP. Shows the matched amount of the underlying Settlement Instruction used for the calculation of the LMFP. This field also shows the T2S relevant currency of the amount of the instruction.
Dedicated Cash Account Number	Shows the cash account stated in the settlement instruction (only in case of settlement instructions against payment).
DCA Owner BIC	Shows the BIC of the owner of the cash account stated in the settlement instruction (only in case of settlement instructions against payment).
Accepted Timestamp	Shows the accepted timestamp of the settlement instruction.
Matched Timestamp	Shows the matched timestamp of the settlement instruction.
Failed Reason	Shows the reason for the instruction not being fully settled at the end of the processing of its cut-off (for SEFP)
Cut-off	Shows the relevant cut-off considered in the calculation of the penalty (for SEFP).
Cut-off Start TS	Shows the start time of execution of the relevant cut-off (for SEFP).
Cut-off End TS	Shows the end time of execution of the relevant cut-off (for SEFP).

Buttons

Buttons	
Removal	<p>This function enables you to remove existing penalties.</p> <p>This button will only be available if the Penalty:</p> <ul style="list-style-type: none"> <input type="checkbox"/> has status 'Active' (ACTV) <input type="checkbox"/> is a 'Debit' <input type="checkbox"/> is in its appeal period (i.e. "In appeal period" is "Yes") <p>By clicking this button the d [▶ 315] will pop up with the relevant information to create a Removal Request based on the Penalty of the screen.</p>
Re-include	<p>This function enables you to re-include penalties with status 'Removed' and reason different from 'Re-allocated'. Upon clicking on the Re-include button you will be asked to enter your PIN for digital signature purposes (NRO). With the entry of the PIN, T2S attaches a digital signature to the modification request entered by the T2S actor.</p> <ul style="list-style-type: none"> <input type="checkbox"/> This button will only be available if the Penalty; <input type="checkbox"/> has status 'Removed' (REMO) <input type="checkbox"/> is a 'Debit' <input type="checkbox"/> is in its appeal period (i.e. "In appeal period" is Yes) <p>By clicking this button the Confirmation prompt will pop-up. Hence, the action is triggered (i.e. the Re-inclusion Request is sent) and the Penalty - details screen is displayed again:</p> <ul style="list-style-type: none"> <input type="checkbox"/> Either updated (i.e. Penalty with new status ACTV, (Active), new Reason Code UPDT (Updated) and description (if applies), penalty amount and Calculation details be-

	<p>for the penalty was removed and the flag To be recalculated set to YES) if the Re-inclusion Request is confirmed and executed (the action was triggered in Two-eyes);</p> <ul style="list-style-type: none"> <input type="checkbox"/> Or not updated if: <ul style="list-style-type: none"> <input type="checkbox"/> the Re-inclusion Request is Validated and Awaiting for Approval (the action was triggered in Four-eyes and the Penalty - details screen shows the ID for the action awaiting for approval) <input type="checkbox"/> the Re-inclusion Request is rejected shows the reason for rejecting the action). <p>References for error messages:</p> <ul style="list-style-type: none"> <input type="checkbox"/> PMMO010 <input type="checkbox"/> PMMO016 <input type="checkbox"/> PMMO031 <input type="checkbox"/> PMMO032
<p>Re-allocate</p>	<p>This function enables you to re-allocate existing penalties if they are LMFP over a Settlement Instruction sent as already matched to T2S.</p> <p>This button will only be available if :</p> <ul style="list-style-type: none"> <input type="checkbox"/> The status of the penalty is “Active” <input type="checkbox"/> It is a LMFP <input type="checkbox"/> The LMFP has not been re-allocated before (i.e. “Re-allocated to/ from penalty” is empty) <input type="checkbox"/> Underlying settlement instruction was sent as already matched to T2S (i.e. “Already Matched Flag” is Yes)

	<ul style="list-style-type: none"> <input type="checkbox"/> The penalty is still in its appeal period (i.e. "In appeal period" is Yes) <p>By clicking this button the Penalty re-allocation screen will pop-up with the relevant information to create a Re-allocation Request based on the Penalty of the screen.</p>
Switch	<p>This function enables you to switch the failing party and non-failing party of existing penalties.</p> <p>This button will only be available if the Penalty:</p> <ul style="list-style-type: none"> <input type="checkbox"/> has status 'Active' (ACTV) <input type="checkbox"/> is a 'Debit' <input type="checkbox"/> is in its appeal period (i.e. "In appeal period" is Yes) <p>By clicking this button the Penalty switch screen will pop-up with the relevant information to create a Switch Request based on the Penalty of the screen.</p>
Revisions	<p>This function enables you to display the revisions of the selected penalty.</p> <p>Next screen:</p> <ul style="list-style-type: none"> <input type="checkbox"/> Revisions/Audit Trail - list Screen [▶ 662]
SI Details	<p>This function enables you to display the details of the relevant settlement instruction.</p> <p>Next screen:</p> <ul style="list-style-type: none"> <input type="checkbox"/> Settlement Instruction - details Screen

2.2.2.25 Monthly Net Penalty Amounts - Search/List Screen

Context of Usage

This screen contains a number of search fields. By inputting the relevant data, you can search for monthly net amounts for the penalties computed by T2S for the business days of a previous month, for a given T2S Party and counterpart(s).

The query allows to search per currency, party and counterparty.

This screen will only return results where the relevant CSD has the right to access the underlying data (i.e. party is in its data scope).

The search results will be displayed in a list when more than one result is retrieved by T2S.

When only one result is retrieved, the relevant aggregated amount resulting from the query will be displayed in the same format used by the list screen.

The monthly net amounts of a particular month will be available only once T2S has produced the Monthly reporting of aggregated amounts of cash penalties for that month.

When exporting the content of this screen, you receive the query result in a csv-file.

This screen is only available for CSD authorised users and T2S Operator user.

Screen Access

Securities >> Settlement >> Monthly Penalties >> *Monthly Net Penalty Amounts – Search/List* screen

Privileges

To use this screen, you need the following privilege:

Monthly Net Penalty Amount Query Privilege

References

User Instructions Part

This screen is part of the following business scenarios:

View monthly net amounts of penalties

Screenshot

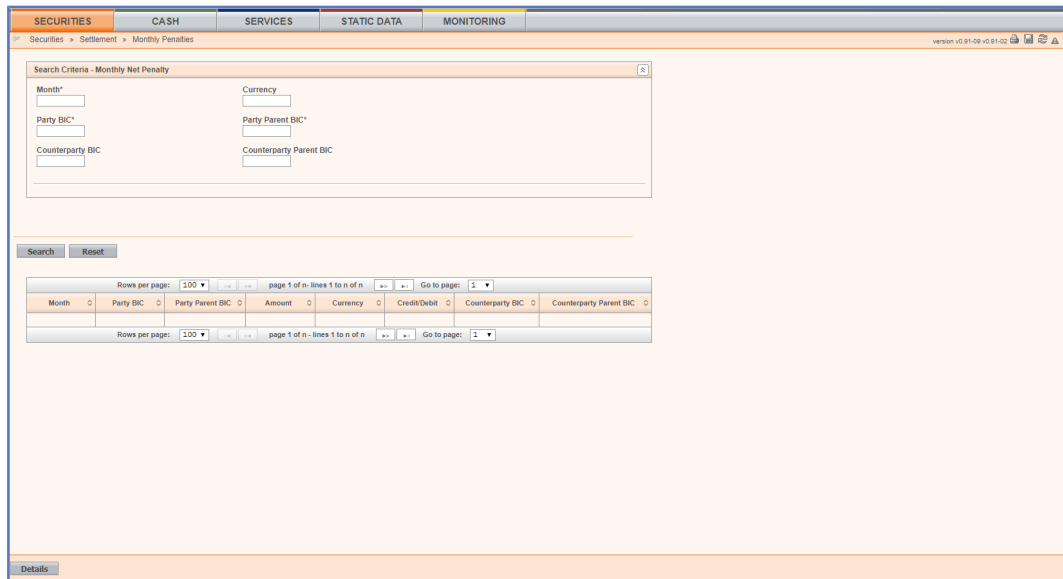

Illustration 64: Monthly net penalty amounts – search/list screen

Field

Description

Monthly Net Penalty Amount – Search Criteria	
Month	<p>Enter the relevant month you search for or select it from the drop-down menu.</p> <p>Only the past 3 months will be available.</p> <p>This parameter is mandatory for queries by Search Criteria.</p> <p>Required format is: YYYY-MM</p>
Currency	<p>Enter the relevant T2S currency of the monthly net penalty amount or use the drop-down menu.</p> <p>The default value is 'All'.</p> <p>Required format is: 3 characters (SWIFT-x)</p>
Party BIC	<p>You can choose to either enter the 'Party BIC' or to select it from the suggested items in the drop-down menu.</p> <p>The selected BIC corresponds to the party imposed with or entitled to receive the amount retrieved by the query.</p> <p>This parameter is mandatory for queries by Search Criteria.</p> <p>Required format is: max. 11 characters (SWIFT-x)</p>

Monthly Net Penalty Amount – Search Criteria	
Party Parent BIC	<p>You can select the ‘Party Parent BIC’ from the suggested items in the drop-down menu.</p> <p>The selected BIC corresponds to the parent of the party imposed with or entitled to receive the amount retrieved by the query.</p> <p>This parameter is mandatory for queries by Search Criteria.</p> <p>In order to determine the data scope of the query, T2S automatically considers the CSD associated to the user performing the query. Hence, the parameter ‘Party Parent BIC’ is only relevant to query those amounts where the CSD itself is reported as failing or non-failing party(for which case, the user needs to input the T2S BIC).</p> <p>Field is empty by default and displays the following values to be input:</p> <ul style="list-style-type: none"> <input type="checkbox"/> CSD BIC <input type="checkbox"/> T2S BIC <p>Required format is: max. 11 characters (SWIFT-x).</p>
Counterparty BIC	<p>You can choose to either enter the ‘Counterparty BIC’ or to select it from the suggested items in the drop-down menu.</p> <p>The selected BIC corresponds to the counterparty entitled to receive or imposed with the amount retrieved by the query.</p> <p>Required format is: max. 11 characters (SWIFT-x).</p>
Counterparty Parent BIC	<p>You can select the ‘Counterparty Parent BIC’ from the suggested items in the drop-down menu.</p>

Monthly Net Penalty Amount – Search Criteria	
	<p>The selected BIC corresponds to the parent of the counterparty entitled to receive or imposed with the amount retrieved by the query.</p> <p>This parameter can be used as search criteria only if the Counterparty BIC is introduced. Hence, this parameter is mandatory when Counterparty BIC is fulfilled.</p> <p>This field displays the BICs of all CSD and the T2S BIC.</p> <p>Required format is: max. 11 characters (SWIFT-x).</p>
Monthly Net Penalty Amount – List	
Month	<p>Shows the relevant month for the amount calculation.</p> <p>Only the aggregated amounts for the past 3 months will be available.</p>
Party BIC	Shows the 'Party BIC' of the party imposed with or entitled to receive the amount retrieved by the query.
Party Parent BIC	Shows the 'Party Parent BIC' of the party imposed with or entitled to receive the amount retrieved by the query.
Amount	<p>Shows the monthly net amount retrieved by the query and equal to:</p> <ul style="list-style-type: none"> <input type="checkbox"/> The sum of all penalties of the relevant month in the relevant currency and that this party is entitled to receive (reported as credit) from the same counterpart (i.e. to be paid by this counterpart); <p>Minus</p>

Monthly Net Penalty Amount – Search Criteria	
	<input type="checkbox"/> The sum of all penalties of the relevant month in the relevant currency, that were imposed to this party (reported as debit), and to be paid to a given counterpart.
Currency	Shows the relevant T2S currency of the monthly net penalty amount.
Credit/Debit	Shows the Credit/Debit Code identifying the monthly net amount as to be debited or credited to the party. Possible values: <ul style="list-style-type: none"> <input type="checkbox"/> DBIT (Debit) <input type="checkbox"/> CRDT (Credit) Note: If the amount is equal to zero, this field is empty.
Counterparty BIC	Shows the 'Counterparty Party BIC' of the party imposed with or entitled to receive the amount retrieved by the query.
Counterparty Parent BIC	Shows the 'Counterparty Parent BIC' of the party imposed with or entitled to receive the amount retrieved by the query.

Buttons

Buttons	
Search	This function enables you to start a search according to the criteria entered. The results are displayed on the list screen. Next screens: <ul style="list-style-type: none"> <input type="checkbox"/> Monthly Net Penalty Amounts – search/list screen
Reset	This function enables you to set all fields to default value and blanks out all optional fields. Next screen:

	<input type="checkbox"/> Monthly Net Penalty Amounts – search/list screen

2.2.2.26 Penalty - Removal Screen

Context of Usage

This screen is accessible by clicking on the “Remove” button of the Penalty – details screen. This action triggers a pop up screen (the Penalty removal screen) that allows entering relevant information to remove the penalty (i.e. the individual Id of the penalty, a drop-down menu to select the reason code and also a text box to insert a description text if the reason selected is OTHR). The confirmation will be completed after clicking on the “Submit” button.

This function is available if the status of the penalty is “Active”, it is a debit and it is still in the appeal period.

The Penalty removal screen is linked to the related Penalty - details screen.

This screen is only available for CSD authorised users and T2S Operator user.

This screen will not be available during the processing of penalties, i.e. between the Events “PMSS” (Penalty Mechanism- Stop Screens and penalty modification requests) and “PMRR” (Penalty Mechanism- Restart GUI and Restart processing penalty modification requests).

Screen Access

- Securities >> Settlement >> Daily Penalties >> *Penalty – search/list* screen >> Click on the *search* button >> *Penalty – details* screen >> Click on the *removal* button
- Securities >> Settlement >> Daily Penalties >> *Penalty – search/list* screen >> Click on the *search* button >> *Penalty – search/list* screen >> Click on the *details* button >> *Penalty – details* screen >> Click on the *removal* button
- Securities >> Settlement >> Settlement Instruction >> *Settlement instructions – search/list* screen >> Click on the *search* and/or *details* button >> *Settlement Instruction – details* screen >> Click on the *associated penalties* button >> *Penalty – details* screen >> Click on the *removal* button

Privileges

To use this screen, you need the following privilege:

- Penalty Details Query Privilege
- Settlement Instruction Audit Trail Query
- Modification of penalties

References

User Instructions Part

This screen is part of the following business scenarios:

- Modification of existing penalties

- View the individual penalty details

Screenshot

Illustration 65: Penalty – removal screen

Field

Description

Penalty Removal	
Individual ID	Shows the individual unique reference assigned to the penalty by T2S. This attribute is passed from previous screen.
Reason	Selects the reason for the removal of the penalty from the possible values: <ul style="list-style-type: none"> <input type="checkbox"/> INSO (removed due to insolvency) <input type="checkbox"/> SESU (removed due to ISIN suspension from SETT) <input type="checkbox"/> SUSP (removed due to ISIN suspension from trading) <input type="checkbox"/> SEMP (removed due to settlement on multiple platforms) <input type="checkbox"/> TECH (removed due to technical impossibilities that prevent settlement) <input type="checkbox"/> OTHR (removed due to another reason)
Description	A free text box to insert a description text if the reason selected is "OTHR". Therefore, description must be fulfilled if the Reason Code is OTHR, otherwise it must be blank.

Buttons**Submit**

This function enables you to complete the Removal Request of the penalty. Upon clicking on the submit button you will be asked to enter your PIN for digital signature purposes (NRO). With the entry of the PIN, T2S attaches a digital signature to the modification request entered by the T2S actor.

When the button is clicked, the pop up is closed and the Penalty – details screen is displayed again as follows:

- Either displayed updated (i.e. Penalty with new status REMO, the corresponding Reason Code and description (if applies), the penalty amount reduced to zero and Calculation Details no longer visible) if the Removal Request is confirmed and executed (the action was triggered in Two-eyes);
- Or not updated if the Removal Request is Validated and Awaiting for Approval (the action was triggered in Four-eyes and the Penalty - details screen shows the ID for the action awaiting for approval).

When the Removal Request is rejected the pop up is closed and the Penalty – details screen is displayed not updated (with the previous values) but showing the reason for rejecting the action.

Next screen:

- Penalty - Details Screen [▶ 291]

References for error messages:

- PMMO010
- PMMO016
- PMMO030

Cancel	<p>This function enables you to get back to the previous screen without removing the penalty.</p> <p>When Penalty – details screen is displayed again, it should be displayed not updated (with the previous values, i.e. still as an active penalty).</p> <p>Next screen:</p> <ul style="list-style-type: none"> <input type="checkbox"/> Penalty - Details Screen [291]
--------	---

2.2.2.27 Penalty - Re-allocation Screen

Context of Usage

This screen is accessible by clicking on the “Re-allocate” button of the Penalty – details screen. This action triggers a pop up screen (the Penalty re-allocation screen) that allows entering the relevant information, to re-allocate the penalty. The confirmation will be completed after clicking on the “Submit” button.

This function is available if the status of the penalty is “Active”, the penalty is a LMFP and the LMFP has not been reallocated before. Furthermore, the underlying instruction must have been sent as already matched to T2S and the penalty must be still in its appeal period.

The Penalty re-allocation screen is linked to the related Penalty – details screen.

This screen is only available for CSD authorised users and T2S Operator user.

This screen will not be available during the processing of penalties, i.e. between the Events “PMSS” (Penalty Mechanism- Stop Screens and penalty modification requests) and “PMRR” (Penalty Mechanism- Restart GUI and Restart processing penalty modification requests).

Screen Access

- Securities >> Settlement >> Daily Penalties >> *Penalty – search/list* screen >> Click on the *search* button >> *Penalty – details* screen >> Click on the *re-allocation* button
- Securities >> Settlement >> Daily Penalties >> *Penalty – search/list* screen >> Click on the *search* button >> *Penalty – search/list* screen >> Click on the *details* button >> *Penalty – details* screen >> Click on the *re-allocation* button
- Securities >> Settlement >> Settlement Instruction >> *Settlement instructions – search/list* screen >> Click on the *search* and/or *details* button >> *Settlement Instruction – details* screen >> Click on the *associated penalties* button >> *Penalty – details* screen >> Click on the *re-allocation* button

Privileges To use this screen, you need the following privilege:

- Penalty Details Query Privilege
- Settlement Instruction Audit Trail Query
- Modification of penalties

References **User Instructions Part**

This screen is part of the following business scenarios:

- Modification of existing penalties
- View the individual penalty details

Screenshot



Illustration 66: Penalty – re-allocation screen

Field

Description

Penalty Re-allocation	
Common ID	Shows the common reference assigned to the penalty by T2S, which is common for both the failing and the non-failing participant. This attribute is passed from previous screen.
New Parties	
New Failing Party BIC	<p>BIC of the Party that will become the failing party of the penalty after the re-allocation.</p> <p>Possible values are the BICs of the underlying Settlement Instruction, as follows:</p> <ul style="list-style-type: none"> <input type="checkbox"/> The BIC of the T2S Delivering Party <input type="checkbox"/> The BIC of the T2S Receiving Party <p>References for error messages:</p> <ul style="list-style-type: none"> <input type="checkbox"/> PMMO021 <input type="checkbox"/> PMMO023
New Non-Failing Party BIC	BIC of the non-failing party of the penalty.

Penalty Re-allocation	
	This field is fulfilled automatically with the other value (BIC) not chosen/selected for the New Failing Party BIC.
T2S Reference of Failing Settlement Instruction	<p>Instruction identification code assigned by T2S to the related settlement instruction.</p> <p>It must be provided in case the two BICs retrieved for the New failing Party BIC are the same</p> <p>Otherwise, it must be blank.</p> <p>References for error messages: PMMO025</p>
Movement of the Failing Settlement Instruction	<p>Shows the Securities Movement Type of the selected Failing Settlement Instruction. (i.e. fulfilled automatically with the Movement Type of the Settlement instruction chosen as T2S Reference of Failing Settlement Instruction).</p> <p>If no Settlement Instruction has been chosen/selected, it must be blank</p>

Buttons

Buttons	
Submit	<p>This function enables you to complete the Re-allocation Request of the penalty. Upon clicking on the submit button you will be asked to enter your PIN for digital signature purposes (NRO). With the entry of the PIN, T2S attaches a digital signature to the modification request entered by the T2S actor.</p> <p>When this button is clicked the pop up is closed and the Penalty – details screen is displayed again as follows:</p> <ul style="list-style-type: none"> <input type="checkbox"/> Either displayed updated (i.e. status “REMO”, reason code “RALO” and the Re-allocated to/from penalty fulfilled with the common ID of the new Penalty) if the Re-allocation Re-

	<p>quest is confirmed and executed (the action was triggered in Two-eyes);</p> <ul style="list-style-type: none"> <input type="checkbox"/> Or not updated if the Re-allocation Request is Validated and Awaiting for Approval (the action was triggered in Four-eyes and the Penalty - details screen shows the ID for the action awaiting for approval). <p>When the Re-allocation Request is rejected (i.e. a reason for rejection is provided) the pop up is closed and the Penalty – details screen shows the reason for rejecting the action.</p> <p>Next screen:</p> <ul style="list-style-type: none"> <input type="checkbox"/> Penalty - Details Screen [▶ 291] <p>References for error messages:</p> <ul style="list-style-type: none"> <input type="checkbox"/> PMMO008 <input type="checkbox"/> PMMO021 <input type="checkbox"/> PMMO023 <input type="checkbox"/> PMMO025 <input type="checkbox"/> PMMO033 <input type="checkbox"/> PMMO034 <input type="checkbox"/> PMMO035 <input type="checkbox"/> PMMO037
<p>Cancel</p>	<p>This function enables you to get back to the previous screen without re-allocating the penalty.</p> <p>When Penalty – details screen is displayed again, it should be displayed not updated (with the old values).</p> <p>Next screen:</p> <ul style="list-style-type: none"> <input type="checkbox"/> Penalty - Details Screen [▶ 291]

2.2.2.28 Penalty - Switch Screen

Context of Usage	<p>This screen is accessible by clicking on the “Switch” button of the Penalty – details screen. This action triggers a pop up screen (the Penalty switch screen) that shows the relevant information to switch the penalty (i.e. the individual Id of the penalty and a free text box to insert a description text). The confirmation will be completed after clicking on the “Submit” button.</p> <p>This function is available if the status of the penalty is “Active”, the penalty is a debit and the penalty is still in the appeal period.</p> <p>The Penalty switch screen is linked to the related Penalty – details screen.</p> <p>This screen is only available for CSD authorised users and T2S Operator user.</p> <p>This screen will not be available during the processing of penalties, i.e. between the Events “PMSS” (Penalty Mechanism- Stop Screens and penalty modification requests) and “PMRR” (Penalty Mechanism- Restart GUI and Restart processing penalty modification requests).</p>
Screen Access	<ul style="list-style-type: none"><input type="checkbox"/> Securities >> Settlement >> Daily Penalties >> <i>Penalty – search/list</i> screen >> Click on the <i>search</i> button >> <i>Penalty – details</i> screen >> Click on the <i>switch</i> button<input type="checkbox"/> Securities >> Settlement >> Daily Penalties >> <i>Penalty – search/list</i> screen >> Click on the <i>search</i> button >> <i>Penalty – search/list</i> screen >> Click on the <i>details</i> button >> <i>Penalty – details</i> screen >> Click on the <i>switch</i> button<input type="checkbox"/> Securities >> Settlement >> Settlement Instruction >> <i>Settlement instructions – search/list</i> screen >> Click on the <i>search</i> and/or <i>details</i> button >> <i>Settlement Instruction – details</i> screen >> Click on the <i>associated penalties</i> button >> <i>Penalty – details</i> screen >> Click on the <i>switch</i> button
Privileges	<p>To use this screen, you need the following privilege:</p> <ul style="list-style-type: none"><input type="checkbox"/> Penalty Details Query Privilege<input type="checkbox"/> Settlement Instruction Audit Trail Query<input type="checkbox"/> Modification of penalties
References	<p>User Instructions Part</p> <p>This screen is part of the following business scenarios:</p> <ul style="list-style-type: none"><input type="checkbox"/> Modification of existing penalties<input type="checkbox"/> View the individual penalty details

Screenshot

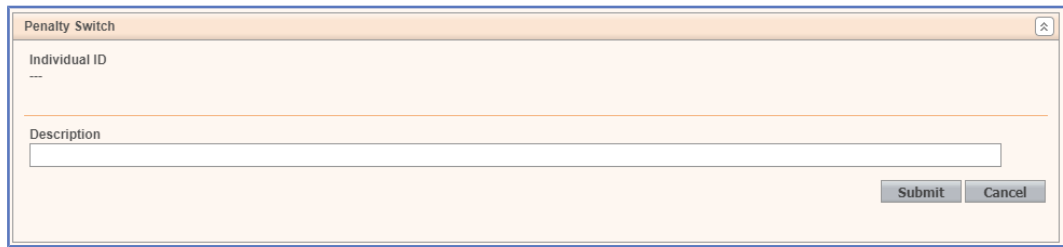

Illustration 67: Penalty - switch screen

Field

Description

Penalty Switch	
Individual ID	Shows the individual unique reference assigned to the penalty by T2S. This attribute is passed from previous screen.
Description	A free text box to insert a description text. This box must be fulfilled.

Buttons

Submit	<p>This function enables you to complete the Switch Request of the penalty. Upon clicking on the submit button you will be asked to enter your PIN for digital signature purposes (NRO). With the entry of the PIN, T2S attaches a digital signature to the modification request entered by the T2S actor.</p> <p>When the button is clicked, the pop up is closed and the Penalty – details screen is displayed again as follows:</p> <ul style="list-style-type: none"> □ Either displayed updated (i.e. status ACTV, reason code SWIC, the description provided by the user, the “Credit/Debit” changed to Credit and the To be recalculated flag set to YES and updated the new Calculation Method when necessary) if the Switch Request is confirmed and executed (the action was triggered in Two-eyes);
--------	---

	<ul style="list-style-type: none"><input type="checkbox"/> Or not updated if the Switch Request is Validated and Awaiting for Approval (the action was triggered in Four-eyes and the Penalty - details screen shows the ID for the action awaiting for approval). <p>When the Switch Request is rejected (i.e. a reason for rejection is provided) and the pop up is closed and the Penalty – details screen shows the reason for rejecting the action.</p> <p>Next screen:</p> <ul style="list-style-type: none"><input type="checkbox"/> Penalty - Details Screen [▶ 291] <p>References for error messages:</p> <ul style="list-style-type: none"><input type="checkbox"/> PMMO010<input type="checkbox"/> PMMO016<input type="checkbox"/> PMMO036
Cancel	<p>This function enables you to back to the previous screen without switching the penalty.</p> <p>When Penalty – details screen is displayed again, it should be displayed with the old values.</p> <p>Next screen:</p> <ul style="list-style-type: none"><input type="checkbox"/> Penalty - Details Screen [▶ 291]

2.3 Cash

2.3.1 Cash Account

2.3.1.1 Cash Forecasts - Search/List Screen

Context of Usage

This screen contains a number of search fields. By inputting the relevant data, you can search for cash forecasts for T2S dedicated cash account owners, i.e. a party which is a payment bank or central bank. The search results will be dis-

played in a list, which is sorted by the values of the 'Party BIC' column in ascending order (default setting). After selecting an entry, you can proceed further by clicking on the buttons below.

The cash forecast takes into account the cash needs and proceeds of a party on all its T2S dedicated cash accounts related to the pending instructions to be settled during the current or the following business day, as well as the liquidity that can be obtained through auto-collateralisation.

When exporting the content of this screen, you receive the list and the corresponding details for each data record.

During the Start of Day, when the CRDM data is being replicated in the Settlement domain, only the cash forecast data available at the End-of-Day of the previous business day is displayed at the screen. The cash forecast data for the new business day is available as of the end of the CRDM data replication.{CR-634}

During night-time, the cash forecast can only be displayed in-between night-time settlement sequences.

There is no usage restriction for this screen.

Screen Access

Cash >> Cash Account >> Cash Forecast

Privileges

To use this screen, you need the following privilege [**▶ 1208**]:

Cash forecast query

References

User Instructions Part

This screen is part of the following business scenario:

View overall liquidity [**▶ 718**]

Business Functionality Document

This screen corresponds to the following business functions:

Query cash forecast (T2S.GUI.LMSE.CSH.0050)

Display cash forecast (T2S.GUI.LMSE.CSH.0060)

Screenshot

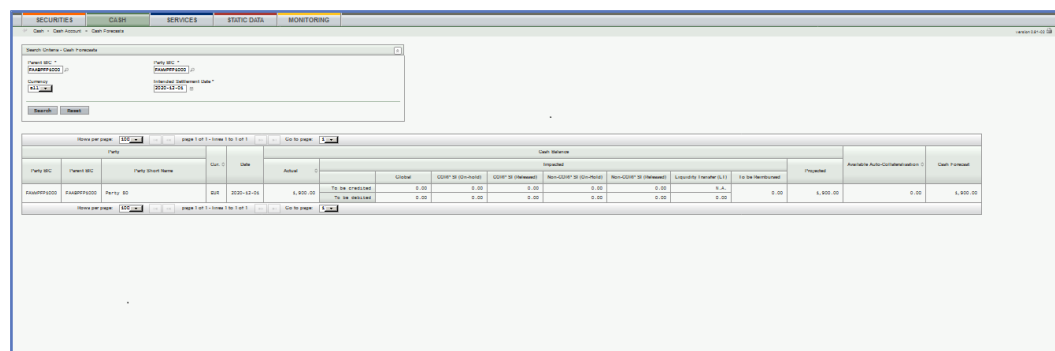

Illustration 68: Cash forecasts – search/list screen

Field Description	Cash Forecast – Search Criteria	
Party BIC*	Select the BIC of the party owning the T2S dedicated cash account(s) from the drop-down menu or search via the <i>magnifier</i> icon.	References for error messages [▶ 1294]: <input type="checkbox"/> QMPC032 <input type="checkbox"/> QMPC084
Parent BIC*	Select the parent BIC of the party owning the T2S dedicated cash account(s) from the drop-down menu.	References for error messages [▶ 1294]: <input type="checkbox"/> QMPC048 <input type="checkbox"/> QMPC084
Currency	Select the currency of the T2S dedicated cash account(s) from the drop-down menu. The default value is 'all'.	Reference for error message [▶ 1294]: <input type="checkbox"/> QMPC054
Intended Settlement Date*	Enter the intended settlement date which is used for the calculation of the cash forecast or use the <i>calendar</i> icon.	Required format is: YYYY-MM-DD The default value is the current business day. This date must be a valid business date equal to or later than the current business date. Reference for error message [▶ 1294]: <input type="checkbox"/> QMPC017
Cash Forecast - List		
Party		
Party BIC	Shows the BIC of the party owning the T2S dedicated cash account(s).	References for error messages [▶ 1294]: <input type="checkbox"/> QMPC032 <input type="checkbox"/> QMPC084
Parent BIC	Shows the parent BIC of the party owning the T2S dedicated cash account(s).	References for error messages [▶ 1294]: <input type="checkbox"/> QMPC048

Cash Forecast – Search Criteria	
	<input type="checkbox"/> QMPC084
Party Short Name	Shows the short name of the party owning the T2S dedicated cash account(s).
Currency	Shows the currency of the T2S dedicated cash account(s). Reference for error message [▶ 1294]: <input type="checkbox"/> QMPC054
Date	Shows the intended settlement date which is used for the calculation of the cash forecast. Displayed format is: YYYY-MM-DD
Cash Balances	
Actual	Shows the sum of the cash balance of the T2S dedicated cash account(s). Provision of '99999...99' in case oversizing occurs in the integer part. Truncation of decimals in case oversizing occurs in the decimal part.
Impacted –To be debited (LT)	Shows the sum of the debiting liquidity transfer orders which debit a T2S dedicated cash account of the party and which would be effective during the date used for the calculation of the cash forecast. Provision of '99999...99' in case oversizing occurs in the integer part. Truncation of decimals in case oversizing occurs in the decimal part.
Impacted - To be credited (SI)	Shows the sum of settlement instructions eligible for cash forecast ³ which credit a T2S dedicated cash account of the party and have an intended settlement date earlier than or equal to the intended settlement date used for the calculation of the cash forecast. Provision of '99999...99' in case oversizing occurs in the integer part. Truncation of decimals in case oversizing occurs in the decimal part.

³ Eligible for cash forecast refers to settlement instructions that are accepted, matched, not cancelled and not finally settled. This definition includes instructions on hold, under intraday restriction.

Cash Forecast – Search Criteria	
Impacted - To be debited (SI)	<p>Shows the sum of settlement instructions eligible for cash forecast which debit a T2S dedicated cash account of the party and have an intended settlement date earlier than or equal to the intended settlement date used for the calculation of the cash forecast.</p> <p>The pending reverse collateral movements are excluded from this sum.</p> <p>Provision of '99999...99' in case oversizing occurs in the integer part. Truncation of decimals in case oversizing occurs in the decimal part.</p>
Impacted - To be credited (SI) – Corporate Actions, On hold	<p>Shows the sum of the settlement instructions related to corporate actions which are eligible for cash forecast, on hold ⁴, credit a T2S dedicated cash account of the party and have an intended settlement date earlier than or equal to the intended settlement date used for the calculation of the cash forecast.</p> <p>Provision of '99999...99' in case oversizing occurs in the integer part. Truncation of decimals in case oversizing occurs in the decimal part.</p>
Impacted –To be credited (SI) – Corporate Actions, Released	<p>Shows the sum of the settlement instructions related to corporate actions which are eligible for cash forecast, released ⁵, credit a T2S dedicated cash account of the party and have an intended settlement date earlier than or equal to the intended settlement date used for the calculation of the cash forecast.</p> <p>Provision of '99999...99' in case oversizing occurs in the integer part. Truncation of decimals in case oversizing occurs in the decimal part.</p>
Impacted –To be credited (SI) – Non Corporate Actions, On hold	<p>Shows the sum of the settlement instructions not related to corporate actions which are eligible for cash forecast, on hold ⁶, credit a T2S dedicated cash account of the party and have an intended settlement date earlier than or equal to the intended settlement date used for the calculation of the cash forecast.</p>

4 'On Hold' includes CSD Hold, Party Hold, CSD Validation Hold, CoSD Hold, and the non-released part of Partially Released instructions.

5 'Released' includes also the released portion of a Partially Released instruction

6 'On Hold' includes CSD Hold, Party Hold, CSD Validation Hold, CoSD Hold, and the non-released part of Partially Released instructions.

Cash Forecast – Search Criteria	
	Provision of '99999...99' in case oversizing occurs in the integer part. Truncation of decimals in case oversizing occurs in the decimal part.
Impacted - To be credited (SI) – Non Corporate Actions, Released	<p>Shows the sum of the settlement instructions not related to corporate actions which are eligible for cash forecast, released ⁷, credit a T2S dedicated cash account of the party and have an intended settlement date earlier than or equal to the intended settlement date used for the calculation of the cash forecast.</p> <p>Provision of '99999...99' in case oversizing occurs in the integer part. Truncation of decimals in case oversizing occurs in the decimal part.</p>
Impacted –To be debited (SI) – Corporate Actions, On hold	<p>Shows the sum of the settlement instructions related to corporate actions which are eligible for cash forecast, on hold, debit a T2S dedicated cash account of the party and have an intended settlement date earlier than or equal to the intended settlement date used for the calculation of the cash forecast.</p> <p>The pending reverse collateral movements are excluded from this sum.</p> <p>Provision of '99999...99' in case oversizing occurs in the integer part. Truncation of decimals in case oversizing occurs in the decimal part.</p>
Impacted - To be debited (SI) – Corporate Actions, Released	<p>Shows the sum of the settlement instructions related to corporate actions which are eligible for cash forecast, released, debit a T2S dedicated cash account of the party and have an intended settlement date earlier than or equal to the intended settlement date used for the calculation of the cash forecast.</p> <p>The pending reverse collateral movements are excluded from this sum.</p> <p>Provision of '99999...99' in case oversizing occurs in the integer part. Truncation of decimals in case oversizing occurs in the decimal part.</p>

⁷ 'Released' includes also the released portion of a Partially Released instruction.

Cash Forecast – Search Criteria	
Impacted – To be debited (SI) – Non Corporate Actions, On hold	<p>Shows the sum of the settlement instructions not related to corporate actions which are eligible for cash forecast, on hold, debit a T2S dedicated cash account of the party and have an intended settlement date earlier than or equal to the intended settlement date used for the calculation of the cash forecast.</p> <p>The pending reverse collateral movements are excluded from this sum.</p> <p>Provision of '99999...99' in case oversizing occurs in the integer part. Truncation of decimals in case oversizing occurs in the decimal part.</p>
Impacted – To be debited (SI) – Non Corporate Actions, Released	<p>Shows the sum of the settlement instructions not related to corporate actions which are eligible for cash forecast, released ⁸, debit a T2S dedicated cash account of the party and have an intended settlement date earlier than or equal to the intended settlement date used for the calculation of the cash forecast.</p> <p>The pending reverse collateral movements are excluded from this sum.</p> <p>Provision of '99999...99' in case oversizing occurs in the integer part. Truncation of decimals in case oversizing occurs in the decimal part.</p>
Impacted - To be reimbursed	<p>Shows the sum of the pending reverse collateral movements which debit a T2S dedicated cash account of the party.</p> <p>Provision of '99999...99' in case oversizing occurs in the integer part. Truncation of decimals in case oversizing occurs in the decimal part.</p>
Projected ⁹	<p>Shows the projected cash balance.</p> <p>The figure consists of the Actual cash balance + To be credited (SI) – To be debited (SI) – To be debited (LT) – To be reimbursed.</p>

8 'Released' includes also the released portion of a Partially Released instruction.

9 In UHB and T2S GUI, "projected balance" means the sum of cash balance and pending LTs and SIs and outstanding intraday credit from auto-collateralisation. In T2S UDFS and MyStandards, "projected balance" means the sum of cash balance and pending LTs and SIs (outstanding intraday credit from auto-collateralisation is not part of the calculation, i.e. is not subtracted).

Cash Forecast – Search Criteria	
	Provision of '99999...99' in case oversizing occurs in the integer part. Truncation of decimals in case oversizing occurs in the decimal part.
Available Auto-Collateralisation	<p>Shows the available auto-collateralisation value of the party.</p> <p>The figure consists of the minimum value between:</p> <ul style="list-style-type: none"> <input type="checkbox"/> The available collateral value that the party holds on the securities account(s) linked to its T2S dedicated cash account(s) <input type="checkbox"/> The auto-collateralisation limit headroom of the party <p>Provision of '99999...99' in case oversizing occurs in the integer part. Truncation of decimals in case oversizing occurs in the decimal part.</p>
Cash Forecast	<p>Shows the sum of the projected cash balance and the available auto-collateralisation.</p> <p>Provision of '99999...99' in case oversizing occurs in the integer part. Truncation of decimals in case oversizing occurs in the decimal part.</p>

Buttons

Search	<p>This function enables you to start a search according to the criteria entered. The results are displayed in a list on the same screen.</p> <p>If the search retrieves a single record, the <i>details</i> screen is displayed directly.</p> <p>Next screens:</p> <ul style="list-style-type: none"> <input type="checkbox"/> <i>Cash forecasts – search/list</i> screen <input type="checkbox"/> <i>Cash forecast – details</i> screen [▶ 332] <p>References for error messages [▶ 1294]:</p> <ul style="list-style-type: none"> <input type="checkbox"/> QMPC017 <input type="checkbox"/> QMPC032 <input type="checkbox"/> QMPC048 <input type="checkbox"/> QMPC054 <input type="checkbox"/> QMPC084
--------	---

Reset	This function enables you to set default search criteria and blanks out all optional criteria. Next screen: <input type="checkbox"/> <i>Cash forecasts – search/list</i> screen
Details	This function enables you to display the details of the selected cash forecast. Next screen: <input type="checkbox"/> <i>Cash forecast - details</i> screen [▶ 332]

2.3.1.2 Cash Forecast - Details Screen

Context of Usage

This screen displays detailed information on the cash forecast for a T2S dedicated cash account owner, i.e. a party which is a payment bank or central bank. The global cash forecast is displayed for the previously selected business date and currency. The cash forecast per T2S dedicated cash account of the party for the previously selected business date and currency is displayed in a list on the same screen. You can check the data and proceed further by clicking on the buttons below.

The cash forecast takes into account the cash needs and proceeds of a party on all its T2S dedicated cash accounts related to the pending instructions to be settled during the current or the following business day, as well as the liquidity that can be obtained through auto-collateralisation.

During the Start of Day, when the CRDM data is being replicated in the Settlement domain, only the cash forecast data available at the End-of-Day of the previous business day is displayed at the screen. The cash forecast data for the new business day is available as of the end of the CRDM data replication.{CR-634}

During night-time, the cash forecast can only be displayed in-between night-time settlement sequences.

There is no usage restriction for this screen.

Screen Access

Cash >> Cash Account >> Cash Forecast >> *Cash forecasts – search/list* screen >> Click on the *search* and/or *details* button

Privileges

No privilege needed to use this screen.

References

User Instructions Part

This screen is part of the following business scenario:

View overall liquidity [▶ 718]

Business Functionality Document

This screen corresponds to the following business functions:

- Display cash forecast (T2S.GUI.LMSE.CSH.0060)

Screenshot

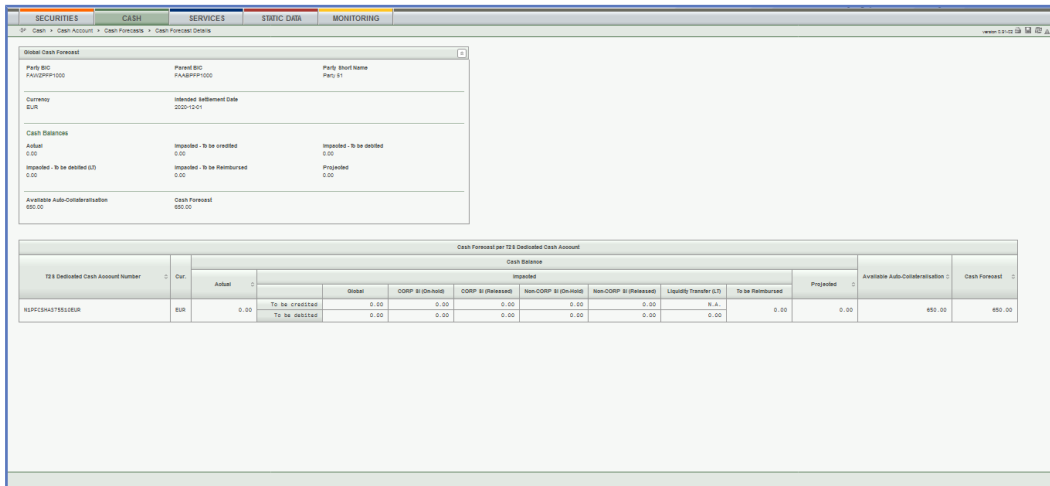

Illustration 69: Cash forecast – details screen

Field Description

Global Cash Forecast	
Party BIC	Shows the BIC of the party owning the T2S dedicated cash account(s).
Parent BIC	Shows the parent BIC of the party owning the T2S dedicated cash account(s).
Currency	Shows the currency of the T2S dedicated cash account(s).
Intended Settlement Date	Shows the intended settlement date used for the calculation of the cash forecast. Displayed format is: YYYY-MM-DD
Cash Balances	
Actual	Shows the sum of the cash balance(s) of the T2S dedicated cash account(s) of the selected party and currency. Provision of '99999...99' in case oversizing occurs in the integer part. Truncation of decimals in case oversizing occurs in the decimal part.
Impacted –To be debited (LT)	Shows the sum of the debiting liquidity transfer orders which debit a T2S dedicated cash account of the selected party and which would be effective during the date used for the calculation of the cash forecast. Provision of '99999...99' in case oversizing occurs in the integer part. Truncation of decimals in case oversizing occurs in the decimal part.

Global Cash Forecast	
Impacted –To be debited (SI)	Shows the sum of settlement instructions eligible for cash forecast which debit a T2S dedicated cash account of the selected party and have an intended settlement date earlier than or equal to the date used for the calculation of the cash forecast ¹⁰ . Provision of '99999...99' in case oversizing occurs in the integer part. Truncation of decimals in case oversizing occurs in the decimal part.
Impacted –To be credited (SI)	Shows the sum of settled settlement instructions eligible for cash forecast which credit a T2S dedicated cash account of the selected party and have an intended settlement date earlier than or equal to the date used for the calculation of the cash forecast. Provision of '99999...99' in case oversizing occurs in the integer part. Truncation of decimals in case oversizing occurs in the decimal part.
Impacted – To be Reimbursed	Shows the sum of the pending reverse collateral movements which debit a T2S dedicated cash account of the selected party. Provision of '99999...99' in case oversizing occurs in the integer part. Truncation of decimals in case oversizing occurs in the decimal part.
Projected ¹¹	Shows the projected cash balance. The figure consists of the sum Actual cash balance + To be credited (SI) – To be debited (SI) – To be debited (LT) – To be reimbursed Provision of '99999...99' in case oversizing occurs in the integer part. Truncation of decimals in case oversizing occurs in the decimal part.
Available Auto-Collateralisation	Shows the available auto-collateralisation. The figure consists of the minimum value between:

10 Eligible for cash forecast refers to settlement instructions that are accepted, matched, not cancelled and not finally settled. This definition includes instructions on hold or under intraday restriction.

11 In UHB and T2S GUI, "projected balance" means the sum of cash balance and pending LTs and SIs and outstanding intraday credit from auto-collateralisation. In T2S UDFS and MyStandards, "projected balance" means the sum of cash balance and pending LTs and SIs (outstanding intraday credit from auto-collateralisation is not part of the calculation, i.e. is not subtracted).

Global Cash Forecast	
	<ul style="list-style-type: none"> <input type="checkbox"/> The available collateral value that the selected party holds on the securities account(s) linked to its T2S dedicated cash account(s) in the selected currency. <input type="checkbox"/> The auto-collateralisation limit headroom of the T2S dedicated cash account(s) of the selected party in the selected currency. <p>Provision of '99999...99' in case oversizing occurs in the integer part. Truncation of decimals in case oversizing occurs in the decimal part.</p>
Cash Forecast	<p>Shows the sum of the projected cash balance and the available auto-collateralisation of the selected party and currency.</p> <p>Provision of '99999...99' in case oversizing occurs in the integer part. Truncation of decimals in case oversizing occurs in the decimal part.</p>
Cash Forecast per T2S Dedicated Cash Account	
T2S Dedicated Cash Account Number	Shows the number of the T2S dedicated cash account of the selected party with a cash balance and/or pending cash movement(s) in the selected currency.
Currency	Shows the currency of the T2S dedicated cash account.
Cash Balances	
Actual	Shows the cash balance of the T2S dedicated cash account.
Impacted –To be debited (LT)	Shows the sum of the debiting liquidity transfer orders which debit the T2S dedicated cash account and which would be effective during the date used for the calculation of the cash forecast.
Impacted –To be debited (SI)	<p>Shows the sum of settlement instructions eligible for cash forecast which debit the T2S dedicated cash account and have an intended settlement date earlier than or equal to the date used for the calculation of the cash forecast.</p> <p>The pending reverse collateral movements are excluded from this sum.</p>
Impacted –To be credited (SI)	Shows the sum of settlement instructions eligible for cash forecast which credit the T2S dedicated cash account and have an intended settlement date earlier than or equal to the date used for the calculation of the cash forecast.

Global Cash Forecast	
Impacted – To be credited (SI) – Corporate Actions, On hold	Shows the sum of the settlement instructions related to corporate actions which are eligible for cash forecast, on hold ¹² , credit a T2S dedicated cash account of the party and have an intended settlement date earlier than or equal to the intended settlement date used for the calculation of the cash forecast.
Impacted –To be credited (SI) – Corporate Actions, Released	Shows the sum of the settlement instructions related to corporate actions which are eligible for cash forecast, released ¹³ , credit a T2S dedicated cash account of the party and have an intended settlement date earlier than or equal to the intended settlement date used for the calculation of the cash forecast.
Impacted –To be credited (SI) – Non Corporate Actions, On hold	Shows the sum of the settlement instructions not related to non corporate actions which are eligible for cash forecast, on hold, credit a T2S dedicated cash account of the party and have an intended settlement date earlier than or equal to the intended settlement date used for the calculation of the cash forecast.
Impacted –To be credited (SI) – Non Corporate Actions, Released	Shows the sum of the settlement instructions not related to corporate actions which are eligible for cash forecast, released, credit a T2S dedicated cash account of the party and have an intended settlement date earlier than or equal to the intended settlement date used for the calculation of the cash forecast.
Impacted –To be debited (SI) – Corporate Actions, On hold	Shows the sum of the settlement instructions related to corporate actions which eligible for cash forecast, on hold, debit a T2S dedicated cash account of the party and have an intended settlement date earlier than or equal to the intended settlement date used for the calculation of the cash forecast. The pending reverse collateral movements are excluded from this sum.
Impacted –To be debited (SI) – Corporate Actions, Released	Shows the sum of the settlement instructions related to corporate actions which are eligible for cash forecast, released, debit a T2S dedicated cash account of the party

12 'On Hold' includes CSD Hold, Party Hold, CSD Validation Hold, CoSD Hold, and the non-released part of Partially Released instructions.

13 'Released' includes also the released portion of a Partially Released instruction.

Global Cash Forecast	
	<p>and have an intended settlement date earlier than or equal to the intended settlement date used for the calculation of the cash forecast.</p> <p>The pending reverse collateral movements are excluded from this sum.</p>
Impacted –To be debited (SI) – Non Corporate Actions, On hold	<p>Shows the sum of the settlement instructions not related to non corporate actions which are eligible for cash forecast, on hold, debit a T2S dedicated cash account of the party and have an intended settlement date earlier than or equal to the intended settlement date used for the calculation of the cash forecast.</p> <p>The pending reverse collateral movements are excluded from this sum.</p>
Impacted –To be debited (SI) – Non Corporate Actions, Released	<p>Shows the sum of the settlement instructions not related to corporate actions which are eligible for cash forecast, released, debit a T2S dedicated cash account of the party and have an intended settlement date earlier than or equal to the intended settlement date used for the calculation of the cash forecast.</p> <p>The pending reverse collateral movements are excluded from this sum.</p>
Impacted – To be Reimbursed	Shows the sum of the pending reverse collateral movements which debit the T2S dedicated cash account.
Projected ¹⁴	<p>Shows the projected cash balance.</p> <p>The figure consists of the sum Actual cash balance + To be credited (SI) - To be debited (SI) - To be debited (LT) - To be reimbursed + impacted collateral movements to be reimbursed</p>
Available Auto-Collateralisation	<p>Shows the available auto-collateralisation.</p> <p>The figure consists of the minimum value between:</p> <ul style="list-style-type: none"> <input type="checkbox"/> The available collateral value that the selected party holds on the securities account(s) linked to the T2S dedicated cash account.

14 In UHB and T2S GUI, "projected balance" means the sum of cash balance and pending LTs and SIs and outstanding intraday credit from auto-collateralisation. In T2S UDFS and MyStandards, "projected balance" means the sum of cash balance and pending LTs and SIs (outstanding intraday credit from auto-collateralisation is not part of the calculation, i.e. is not subtracted).

Global Cash Forecast	
	<input type="checkbox"/> The auto-collateralisation limit headroom of the T2S dedicated cash account.
Cash Forecast	Shows the sum of the projected balance and the available auto-collateralisation for the T2S dedicated cash account.

2.3.1.3 Cash Restriction Details - Search/List Screen

Context of Usage

This screen contains a number of search fields. By inputting the relevant data, you can search for cash restrictions which are sub-balances blocked or reserved for specific purpose. The search results will be displayed in a list, which is sorted by the values of the 'T2S Dedicated Cash Account Number' column in ascending order (default setting). After selecting an entry, you can proceed further by clicking on the buttons below.

During the Start of Day, when the CRDM data is being replicated in the Settlement domain, only the cash restriction details data available at the End-of-Day of the previous business day is displayed at the screen. The cash restriction details data for the new business day is available as of the end of the CRDM data replication.{CR-634}

During night-time, the cash restriction details can only be displayed in-between night-time settlement sequences.

There is no usage restriction for this screen.

Screen Access

- Cash >> Cash Account >> Cash Restriction
- Cash >> Cash Account >> Cash Account Balance >> *T2S dedicated cash account balances – search/list* screen >> Click on the *search* and/or *details* button >> *T2S dedicated cash account balance – details* screen >> Click on the *restriction reference* button
- Monitoring >> Monitoring >> Cash Account Balance >> *T2S dedicated cash account balances – search/list* screen >> Click on the *search* and/or *details* button >> *T2S dedicated cash account balance – details* screen >> Click on the *restriction reference* button
- Cash >> Settlement >> Intra-Balance Movement >> *Intra-balance movements with current and historical status – search* screen >> Click on the *search* button >> *Intra-balance movements – list* screen >> Click on the *details* button >> *Intra-balance movement – details* screen >> Click on the *cash balance details* button >> *T2S dedicated cash account balance – details* screen >> Click on the *restriction reference* button

Privileges

To use this screen, you need the following privilege [► 1208]:

- T2S dedicated cash account balance detailed restrictions query

References

User Instructions Part

This screen is part of the following business scenario:

- View cash balances details and related restrictions [▶ 715]

Business Functionality Document

This screen corresponds to the following business functions:

- Display T2S dedicated cash account balances (T2S.GUI.LMSE.CSH.0020)

Screenshot

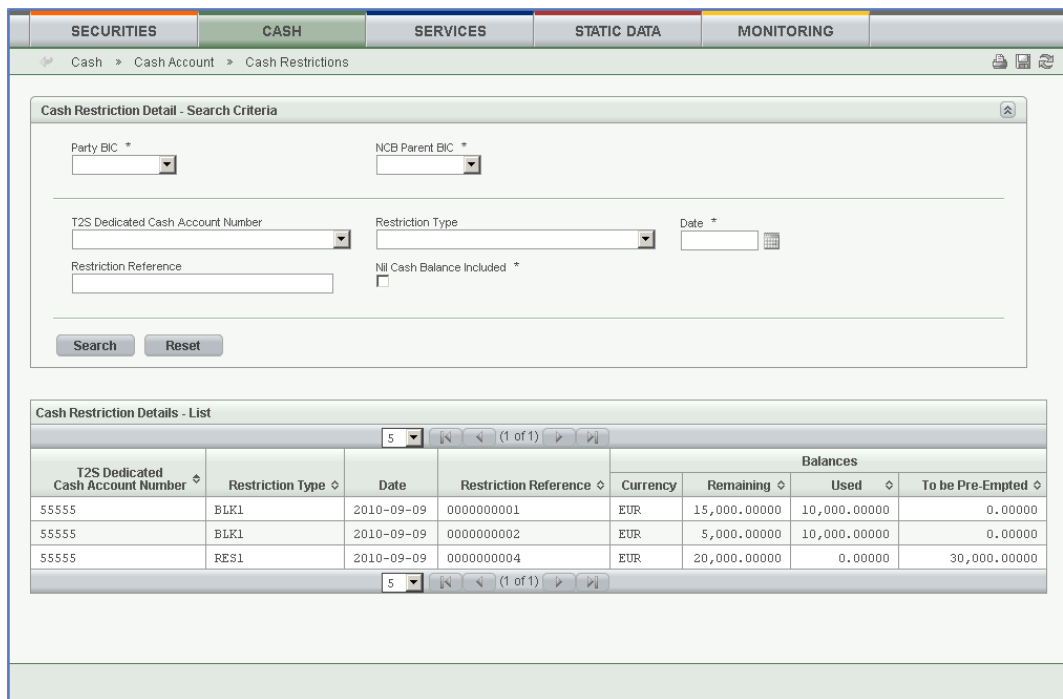

Illustration 70: Cash restriction details – search/list screen

Field Description

Cash Restriction Details – Search Criteria	
Party BIC*	<p>You can choose to either enter the BIC of the party or to select it from the suggested items in the drop-down menu.</p> <p>Required format is: max. 11 characters (SWIFT-x)</p> <p>References for error messages:</p> <ul style="list-style-type: none"> <input type="checkbox"/> QMPC032 <input type="checkbox"/> QMPC084
NCB Parent BIC*	<p>You can choose to either enter the parent BIC of the party or to select it from the suggested items in the drop-down menu.</p> <p>Required format is: max. 11 characters (SWIFT-x)</p> <p>References for error messages:</p> <ul style="list-style-type: none"> <input type="checkbox"/> QMPC048

Cash Restriction Details – Search Criteria	
	<input type="checkbox"/> QMPC084
T2S Dedicated Cash Account Number	Select the number of the T2S dedicated cash account to which the cash restriction applies from the drop-down menu. If there is only one possible account for your privileges, this field is already filled in.
Restriction Type	You can choose to either enter the type of the cash restriction or to select it from the drop-down menu. Required format is: max. 4 characters (SWIFT-x) Reference for error message: <input type="checkbox"/> QMPC091
Date	Enter the date of the movement(s) related to the restricted cash balance(s) or use the <i>calendar</i> icon. The default value is the current business day. Required format is: YYYY-MM-DD This date must be a valid business date earlier than or equal to the current business date.
Restriction Reference	Enter the identification of the cash restriction. Required format is: max. 16 characters (SWIFT-x)
Nil Cash Balance Included*	Select if cash balances equal to 0 are included. The default value is 'No'(checkbox not checked).
Cash Restriction Details - List	
T2S Dedicated Cash Account Number	Shows the number of the T2S dedicated cash account to which the cash restriction applies.
Restriction Type	Shows the restriction type of the cash restriction. Reference for error message: <input type="checkbox"/> QMPC091
Balance Date and Time	Shows the date and time of the last movement related to the cash restriction. Displayed format is: YYYY-MM-DD hh:mm:ss:µsµsµsµsµs
Restriction Reference	Shows the identification of the cash restriction.
Balances	
Currency	Shows the currency of the cash restriction.
Remaining	Shows the amount of the cash restriction remaining.

Cash Restriction Details – Search Criteria	
Used	Shows the amount of the cash restriction that is used.
To be Pre-Empted	Shows the amount of the cash restriction that is to be pre-empted.

Buttons

Buttons	
Search	<p>This function enables you to start a search according to the criteria entered. The results are displayed in a list on the same screen.</p> <p>If the search retrieves a single record, the <i>details</i> screen is displayed directly.</p> <p>Next screen:</p> <ul style="list-style-type: none"> <input type="checkbox"/> Cash restriction details – search/list screen <p>References for error messages:</p> <ul style="list-style-type: none"> <input type="checkbox"/> QMPC032 <input type="checkbox"/> QMPC048 <input type="checkbox"/> QMPC084 <input type="checkbox"/> QMPC091
Reset	<p>This function enables you to set default search criteria and blanks out all optional criteria.</p> <p>Next screen:</p> <ul style="list-style-type: none"> <input type="checkbox"/> Cash restriction details – search/list screen

2.3.1.4 Collateral Values of a Security - Search/List Screen

Context of Usage

This screen contains a number of search fields. By inputting the relevant data, you can search for the collateral value of a security for a specific T2S dedicated cash account and security. The search results will be displayed in a list, which is sorted by the values of the 'T2S Dedicated Cash Account Number' column in ascending order (default setting). After selecting an entry, you can proceed further by clicking on the buttons below.

During the Start of Day, when the CRDM data is being replicated in the Settlement domain, only the collateral value of a security data available at the End-of-Day of the previous business day is displayed at the screen. The collateral value of a security data for the new business day is available as of the end of the CRDM data replication.{CR-634}

During night-time, the collateral value of a security can only be displayed in-between night-time settlement sequences.

There is no usage restriction for this screen.

Screen Access

- Cash >> Cash Account >> Collateral Values (Security)
- Cash >> Cash Account >> Collateral Values (T2S DCA and Sec.) >> *Collateral value per T2S dedicated cash account and security – search/list* screen >> Click on the *collateral value of securities* button

Privileges

To use this screen, you need the following privilege [▶ 1209]:

- Collateral value of a security query

References

User Instructions Part

This screen is not part of a business scenario.

Business Functionality Document

This screen corresponds to the following business functions:

- Query current collateral value of security (per securities account) (T2S.GUI.LMSE.CSH.0130)
- Display current collateral value of security (per securities account) (T2S.GUI.LMSE.CSH.0140)

Screenshot

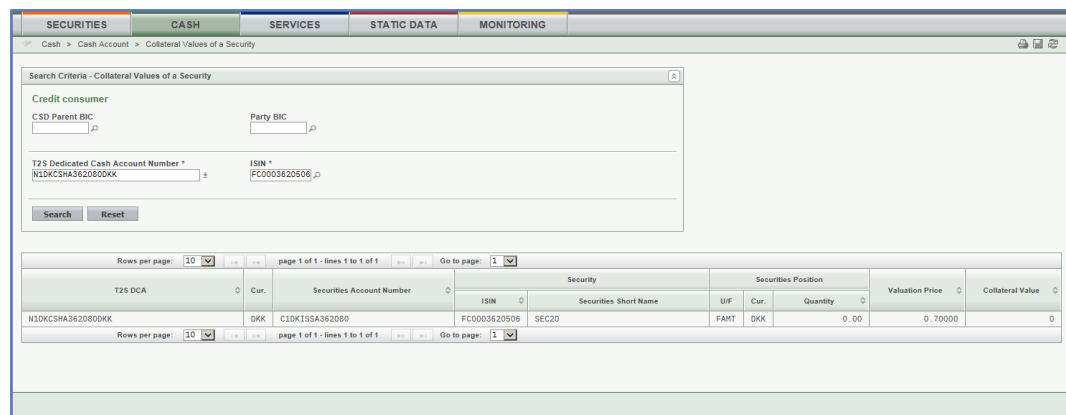

Illustration 71: Collateral value of a security – search/list screen

Field

Description

Collateral Value of a Security – Search Criteria	
Credit Consumer	
Party BIC	<p>You can choose to either enter the BIC of the securities account owner or to select it from the suggested items in the drop-down menu.</p> <p>References for error messages [▶ 1295]:</p> <ul style="list-style-type: none"> <input type="checkbox"/> QMPC032 <input type="checkbox"/> QMPC084

Collateral Value of a Security – Search Criteria	
	If the 'Party BIC' field is filled in, the 'CSD Parent BIC' field must also be filled in.
CSD Parent BIC	<p>You can choose to either enter the parent BIC of the CSD or to select it from the suggested items in the drop-down menu.</p> <p>References for error messages [▶ 1295]:</p> <ul style="list-style-type: none"> <input type="checkbox"/> QMPC032 <input type="checkbox"/> QMPC084 <p>If the 'CSD Parent BIC' field is filled in, the 'Party BIC' field must also be filled in.</p>
T2S Dedicated Cash Account Number*	<p>You can choose to either enter the number of the T2S dedicated cash account or to select it from the suggested items in the drop-down menu.</p> <p>Reference for error message [▶ 1295]:</p> <ul style="list-style-type: none"> <input type="checkbox"/> QMPC031 <p>If only one account is possible, this field is already filled in.</p>
ISIN*	<p>Select the ISIN of the security from the drop-down menu.</p> <p>Required format is: max. 12 characters (SWIFT-x)</p> <p>Reference for error message [▶ 1295]:</p> <ul style="list-style-type: none"> <input type="checkbox"/> QMPC018
Collateral Value of a Security – List	
T2S Dedicated Cash Account Number	<p>Shows the number of the T2S dedicated cash account related to the collateral value of the security list item.</p> <p>Reference for error message [▶ 1295]:</p> <ul style="list-style-type: none"> <input type="checkbox"/> QMPC031
Currency	Shows the currency of the T2S dedicated cash account.
Securities Account Number	Shows the number of the securities account related to the collateral value of the security list item.
Security	
ISIN	<p>Shows the ISIN of the security.</p> <p>Reference for error message [▶ 1295]:</p> <ul style="list-style-type: none"> <input type="checkbox"/> QMPC018

Collateral Value of a Security – Search Criteria	
Securities Short Name	Shows the short name of the security.
Securities Position	
Settlement Type	Shows the quantity type related to the securities from the possible values: <input type="checkbox"/> UNIT <input type="checkbox"/> FAMT (for face amount)
Currency	Shows the currency related to the securities if expressed in face amount.
Quantity	Shows the total quantity of securities for the aggregated securities positions. Provision of '99999...99' in case oversizing occurs in the integer portion. Truncation of decimals in case oversizing occurs in the decimal portion.
Valuation Price	Shows the valuation price of the securities for the credit provider (CB or settlement bank).
Collateral Value	Shows the resulting collateral value of the security for the aggregated securities positions. Provision of '99999...99' in case oversizing occurs in the integer portion. Truncation of decimals in case oversizing occurs in the decimal portion.

Buttons

Search	<p>This function enables you to start a search according to the criteria entered. The results are displayed in a list on the same screen.</p> <p>Next screen:</p> <ul style="list-style-type: none"> <input type="checkbox"/> <i>Collateral value of a security – search/list screen</i> <p>References for error messages [▶ 1295]:</p> <ul style="list-style-type: none"> <input type="checkbox"/> QMPC018 <input type="checkbox"/> QMPC031 <input type="checkbox"/> QMPC032 <input type="checkbox"/> QMPC084
Reset	This function enables you to set default search criteria and blanks out all optional criteria.

Next screen:	
	<input type="checkbox"/> <i>Collateral value of a security – search/list screen</i>

2.3.1.5 Collateral Values per T2S Dedicated Cash Account and Security - Search/List Screen

Context of Usage

This screen contains a number of search fields. By inputting the relevant data, you can search for the collateral value for a party and any or all of its T2S dedicated cash accounts. The search results will be displayed in a list, which is sorted by the values of the (1) 'T2S Dedicated Cash Account Number' (2) Owner of the Securities Account Parent BIC (3) Owner of the Securities Account Party BIC (4) Security-ISIN columns in ascending order (default setting).

During the Start of Day, when the CRDM data is being replicated in the Settlement domain, only the collateral value per T2S dedicated cash account data available at the End-of-Day of the previous business day is displayed at the screen. The collateral value per T2S dedicated cash account data for the new business day is available as of the end of the CRDM data replication.{CR-634}

During night-time, the collateral value per T2S dedicated cash account and security can only be displayed in-between night-time settlement sequences.

There is no usage restriction for this screen.

Screen Access

- Cash >> Cash Account >> Collateral Values (T2S DCA and Sec.)
- Cash >> Cash Account >> Total Collateral Values (T2S DCA) >> *Total collateral value per T2S dedicated cash account – search/list screen* >> Click on *detail of collateral value* button

Privileges

To use this screen, you need the following privilege [▶ 1209]:

- Collateral value per T2S dedicated cash account query

References

User Instructions Part

This screen is not part of a business scenario.

Business Functionality Document

This screen corresponds to the following business functions:

- Query total current collateral value (per T2S dedicated cash account and security) (T2S.GUI.LMSE.CSH.0110)
- Display total current collateral value (per T2S dedicated cash account and security) (T2S.GUI.LMSE.CSH.0120)

Screenshot

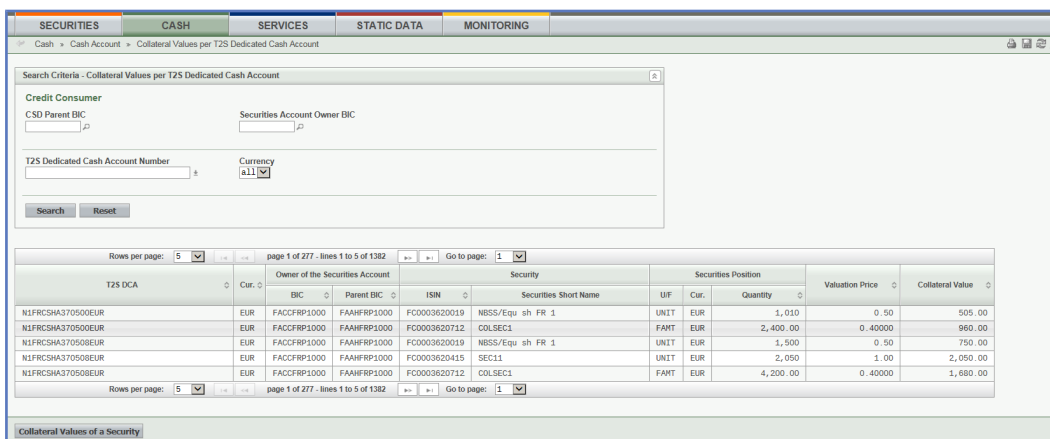

Illustration 72: Collateral value per T2S dedicated cash account and security – search/list screen

Field Description

Collateral Value per T2S Dedicated Cash Account and Security – Search Criteria	
Credit Consumer	
Securities Account Owner BIC	Select the BIC of the securities account owner (credit consumer) from the drop-down menu or search via the <i>magnifier</i> icon. If the BIC is not contained in the drop-down menu please enter the BIC manually. References for error messages [1295]: <input type="checkbox"/> QMPC032 <input type="checkbox"/> QMPC084 If none of the fields are filled in, then the privileges and access rights of the requesting party are applied.
CSD Parent BIC	Select the parent BIC of the CSD (of the credit consumer) from the drop-down menu or search via the <i>magnifier</i> icon. If the BIC is not contained in the drop-down menu please enter the BIC manually. References for error messages [1295]: <input type="checkbox"/> QMPC032 <input type="checkbox"/> QMPC084 If none of the fields are filled in, then the privileges and access rights of the requesting party are applied.
T2S Dedicated Cash Account Number	Select the number of the T2S dedicated cash account from the drop-down menu. Reference for error message [1295]: <input type="checkbox"/> QMPC031 If only one account is possible, this field is already filled in.

Collateral Value per T2S Dedicated Cash Account and Security – Search Criteria	
	If none of the fields are filled in, then the privileges and access rights of the requesting party are applied.
Currency	Select the currency of the T2S dedicated cash account from the drop-down menu. The default value is 'all'.
Collateral Value per T2S Dedicated Cash Account and Security – List	
T2S Dedicated Cash Account Number	Shows the number of the T2S dedicated cash account relating to the collateral value of the security list item. Reference for error message [▶ 1295]: <input type="checkbox"/> QMPC031
Currency	Shows the currency of the T2S dedicated cash account.
Securities Account Owner	
Party BIC	Shows the BIC of the securities account owner of the securities account that holds the valuated securities
Parent BIC	Shows the parent BIC of the securities account owner
Security	
ISIN	Shows the ISIN of the security.
Securities Short Name	Shows the short name of the security.
Securities Positions	
Settlement Type	Shows the quantity type related to the securities from the possible values: <input type="checkbox"/> Unit <input type="checkbox"/> FAMT (for face amount)
Currency	Shows the currency related to the securities if expressed in face amount.
Quantity	Shows the total quantity of securities for the aggregated securities positions. Provision of '99999...99' in case oversizing occurs in the integer portion. Truncation of decimals in case oversizing occurs in the decimal portion.
Valuation Price	Shows the valuation price of the securities for the credit provider (CB or settlement bank).

Collateral Value per T2S Dedicated Cash Account and Security – Search Criteria	
Collateral Value	Shows the resulting collateral value of the security for the aggregated securities positions. Provision of '99999...99' in case oversizing occurs in the integer portion. Truncation of decimals in case oversizing occurs in the decimal portion.

Buttons

Buttons	
Search	This function enables you to start a search according to the criteria entered. The results are displayed in a list on the same screen. Next screen: <input type="checkbox"/> <i>Collateral value per T2S dedicated cash account and security – search/list screen</i> References for error messages [▶ 1295]: <input type="checkbox"/> QMPC031 <input type="checkbox"/> QMPC032 <input type="checkbox"/> QMPC084
Reset	This function enables you to set default search criteria and blanks out all optional criteria. Next screen: <input type="checkbox"/> <i>Collateral value per T2S dedicated cash account and security – search/list screen</i>
Collateral Value of Securities	This function enables you to search for the collateral value of a security. Next screen: <input type="checkbox"/> <i>Collateral value of a security – search/list screen [▶ 341]</i> The values of the selected entry are passed to the next screen as search criteria.

2.3.1.6 Limits - Search/list Screen

See *Limits – search/list Screen*

2.3.1.7 Limit - New/Edit Screen

See *Limit – New/Edit Screen*.

2.3.1.8 Limit Utilisation - Search/List Screen

Context of Usage

This screen contains a number of search fields. By inputting the relevant data, you can search for the current limit utilisation for a given credit consumer. Depending on the input criteria, a credit consumer or credit provider can retrieve the following information:

- CBs, as credit provider, can see the utilisation of an auto-collateralisation limit associated to the T2S dedicated cash accounts of its payment banks;
- Payment banks, as credit consumer, can see the utilisation of their auto-collateralisation limit associated to their T2S dedicated cash accounts;
- Payment banks, as credit provider, can see the utilisation of the limits of their clients (three types of limits – external guarantee, auto-collateralisation, unsecured credit) associated to the Payment banks T2S dedicated cash accounts;
- Payment bank clients, as credit consumer, can see the utilisation of their limits (three types of limits – external guarantee, auto-collateralisation, unsecured credit) associated to the T2S dedicated cash accounts of their payment banks.

The search results will be displayed in a list, which is sorted by the value of the columns 'Credit Provider Party BIC', in ascending order (default setting). After selecting an entry, you can proceed further by clicking the buttons below.

During the Start of Day, when the CRDM data is being replicated in the Settlement domain, only the limit utilisation data available at the End-of-Day of the previous business day is displayed at the screen. The limit utilisation data for the new business day is available as of the end of the CRDM data replication.{CR-634}

During night-time, the limit utilisation can only be displayed in-between night-time settlement sequences.

There is no usage restriction for this screen.

Screen Access

- Cash >> Cash Account >> Limit Utilisation
- Securities >> Securities Account >> Limit Utilisation
- Static Data >> T2S Dedicated Cash Account >> Limits >> *Limits – search/list* screen >> Click on the *limit utilisation* button
- Cash >> Cash Account >> Limits >> *Limits – search/list* screen >> Click on the *limit utilisation* button
- Static Data >> T2S Dedicated Cash Account >> T2S Dedicated Cash Account >> *T2S dedicated cash accounts – search/list* screen >> Click on the *search* and/or *details* button >> *T2S dedicated cash account – details* screen >> Click on the *limits* button >> *Limits – search/list* screen >> Click on the *limit utilisation* button

- Static Data >> Parties >> Parties >> **Parties – search/list screen** >> Click on the *search* and/or *details* button >> **Party – details screen** >> Click on the *T2S dedicated cash account* button >> **T2S dedicated cash accounts – search/list screen** >> Click on the *search* and/or *details* button >> **T2S dedicated cash account – details screen** >> Click on the *limits* button >> **Limits – search/list screen** >> Click on the *limit utilisation* button

Privileges

To use this screen, you need the following privilege [▶ 1218]:

- Limit utilisation query

References

User Instructions Part

This screen is part of the following business scenario:

- View overall liquidity [▶ 718]

Business Functionality Document

This screen corresponds to the following business functions:

- Display limit utilisation (T2S.GUI.SDSE.LMT.0080)
- Query limit utilisation (T2S.GUI.SDSE.LMT.0070)

Screenshot

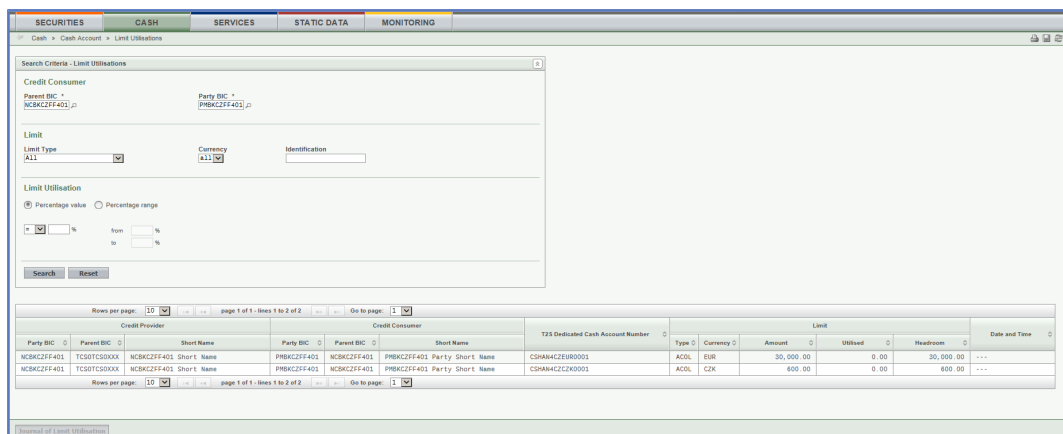

Illustration 73: Limit utilisation – search/list screen

Field

Description

Limit Utilisation – Search Criteria	
Credit Consumer	
Party BIC	You can choose to either enter the BIC of the party or to select it from the suggested items in the drop-down menu. If the querying party is a CB or a payment/settlement bank, the Party BIC is optional, otherwise it is mandatory. Required format is: max. 11 characters (SWIFT-x)
Parent BIC	You can choose to either enter the parent BIC of the party or to select it from the suggested items in the drop-down menu.

Limit Utilisation – Search Criteria	
	<p>If the querying party is a CB or a payment/settlement bank, the Party BIC is optional, otherwise it is mandatory.</p> <p>Required format is: max. 11 characters (SWIFT-x)</p>
Limit	
Limit Type	<p>Select the limit type from one of the possible values:</p> <ul style="list-style-type: none"> <input type="checkbox"/> All (default value) <input type="checkbox"/> EXGT (External Guarantee) <input type="checkbox"/> ACOL (Auto-collateralisation) <input type="checkbox"/> UCDT (Unsecured Credit) <p>If the querying party is a CB, the only possible value is 'ACOL'.</p>
Currency	<p>Select the currency of the T2S dedicated cash account from the drop-down menu. The default value is 'all'.</p>
Identification	<p>Enter the technical identifier of the limit.</p> <p>Required format: Integer</p> <p>Reference for error message: [▶ 1369]</p> <ul style="list-style-type: none"> <input type="checkbox"/> QMPC036
Limit Utilisation	
Percentage value	<p>Select whether the limit utilisation criteria is by percentage value.</p> <p>Select the limit utilisation operator from one of the possible values:</p> <ul style="list-style-type: none"> <input type="checkbox"/> = (default value) <input type="checkbox"/> >= <input type="checkbox"/> > <input type="checkbox"/> <= <input type="checkbox"/> < <p>Enter the limit utilisation as a percentage.</p> <p>Required format is: max. 5 digit(s) incl. decimal point (thereof max. 2 decimal places and decimal point)</p>
Percentage range	<p>Select whether the limit utilisation criteria is by percentage range.</p> <p>Enter the 'From' range delimiter of the limit utilisation as a percentage.</p>

Limit Utilisation – Search Criteria	
	<p>Required format is: max. 5 digit(s) incl. decimal point (thereof max. 2 decimal places and decimal point).</p> <p>Enter the 'To' range delimiter of the limit utilisation as a percentage.</p> <p>Required format is: max. 5 digit(s) incl. decimal point (thereof max. 2 decimal places and decimal point).</p> <p>Both fields must be filled in if the range of value is selected.</p> <p>Reference for error message: [▶ 1369]</p> <p><input type="checkbox"/> QMPC040</p>
Limit Utilisation – List	
Credit Provider	
Party BIC	Shows the BIC of the credit provider.
Parent BIC	Shows the parent BIC of the credit provider.
Short Name	Shows the party short name of the credit provider.
Credit Consumer	
Party BIC	Shows the BIC of the credit consumer.
Parent BIC	Shows the parent BIC of the credit consumer.
Short Name	Shows the party short name of the credit consumer.
T2S Dedicated Cash Account Number	Shows the number of the T2S dedicated cash account relating to the limit utilisation.
Limit Type	
Limit Type	<p>Shows the type of the limit from one of the possible values:</p> <p><input type="checkbox"/> EXGT (External Guarantee)</p> <p><input type="checkbox"/> ACOL (Auto-collateralisation)</p> <p><input type="checkbox"/> UCDD (Unsecured Credit)</p>
Currency	Shows the currency of the T2S dedicated cash account.
Amount	Shows the amount of the limit.
Used amount	Shows the amount of the limit that has been utilised.
Headroom	Shows the headroom of the limit.
Date and Time	<p>Shows the date and time of the most recent usage of the limit.</p> <p>Displayed format is: YYYY-MM-DD hh:mm:ss:µsµsµsµsµsµs</p>

Buttons

Search	<p>This function enables you to start a search according to the criteria entered. The results are displayed in a list on the same screen.</p> <p>Next screen:</p> <ul style="list-style-type: none"><input type="checkbox"/> <i>Limit utilisation – search/list</i> screen <p>References for error messages: [▶ 1369]</p> <ul style="list-style-type: none"><input type="checkbox"/> QMPC036<input type="checkbox"/> QMPC040
Reset	<p>This function enables you to set default search criteria and blanks out all optional criteria.</p> <p>Next screen:</p> <ul style="list-style-type: none"><input type="checkbox"/> <i>Limit utilisation – search/list</i> screen
Journal of a Limit Utilisation	<p>This function enables you to display the details of the journal of limit utilisation for the selected limit. The values of the selected row are passed as selection criteria to the next screen.</p> <p>Next screen:</p> <ul style="list-style-type: none"><input type="checkbox"/> <i>Limit utilisation journal – search/list</i> screen [▶ 353]

2.3.1.9 Limit Utilisation Journal - Search/List Screen

Context of Usage

This screen contains a number of search fields. By inputting the relevant data, you can search for the current limit utilisation journal for a given credit consumer. Depending on the input criteria, a credit consumer or credit provider can retrieve following information:

- CBs, as credit provider, can see the utilisation journal of an auto-collateralisation limit associated to the T2S dedicated cash accounts of its payment banks;
- Payment banks, as credit consumer, can see the utilisation journal of their auto-collateralisation limit associated to their T2S dedicated cash accounts;
- Payment banks, as credit provider, can see the utilisation journal of the limits of their clients (three types of limits – external guarantee, auto-collateralisation, unsecured credit) associated to the Payment banks T2S dedicated cash accounts;

- Payment bank clients, as credit consumer, can see the utilisation journal of their limits (three types of limits – external guarantee, auto-collateralisation, unsecured credit) associated to the T2S dedicated cash accounts of their payment banks.

The search results will be sorted before being displayed in a list by the values of the following columns in descending order:

1. T2S Dedicated Cash Account Number
2. Credit consumer
3. Limit Type

The results cannot be sorted afterwards.

After selecting an entry, you can proceed further by clicking the buttons below.

During the Start of Day, when the CRDM data is being replicated in the Settlement domain, only the limit utilisation Journal data available at the End-of-Day of the previous business day is displayed at the screen. The limit utilisation Journal data for the new business day is available as of the end of the CRDM data replication.{CR-634}

During night-time, the limit utilisation journal can only be displayed in-between night-time settlement sequences.

There is no usage restriction for this screen.

Screen Access

- Cash >> Cash Account >> Limit Utilisation Journal
- Securities >> Securities Account >> Limit Utilisation Journal
- Static Data >> T2S Dedicated Cash Account >> Limits >> *Limits – search/list* screen >> Click on the *limit utilisation* button >> *Limit utilisation – search/list* screen >> Click on the *journal of limit utilisation* button
- Cash >> Cash Account >> Limits >> *Limits – search/list* screen >> Click on the *limit utilisation* button >> *Limit utilisation – search/list* screen >> Click on the *journal of limit utilisation* button
- Static Data >> T2S Dedicated Cash Account >> T2S Dedicated Cash Account >> *T2S dedicated cash accounts – search/list* screen >> Click on the *search* and/or *details* button >> *T2S dedicated cash account – details* screen >> Click on the *limits* button >> *Limits – search/list* screen >> Click on the *limit utilisation* button >> *Limit utilisation – search/list* screen >> Click on the *journal of limit utilisation* button
- Static Data >> Parties >> Parties >> *Parties – search/list* screen >> Click on the *search* and/or *details* button >> *Party – details* screen >> Click on the *T2S dedicated cash account* button >> *T2S dedicated cash accounts –*

search/list screen >> Click on the *search* and/or *details* button >> *T2S dedicated cash account – details* screen >> Click on the *limits* button >> *Limits – search/list* screen >> Click on the *limit utilisation* button >> *Limit utilisation – search/list* screen >> Click on the *journal of limit utilisation* button

- Cash >> Liquidity >> Outstanding Auto-Coll. Credit >> *Outstanding auto-collateralisation credits – search/list* screen >> Click on the *journal of limit utilisation* button

Privileges

To use this screen, you need the following privilege [**▶ 1218**]:

- Limit utilisation journal query

References

User Instructions Part

This screen is part of the following business scenario:

- View overall liquidity [**▶ 718**]

Business Functionality Document

This screen corresponds to the following business functions:

- Query limit utilisation journal (T2S.GUI.SDSE.LMT.0090)
- Display limit utilisation journal (T2S.GUI.SDSE.LMT.0100)

Screenshot

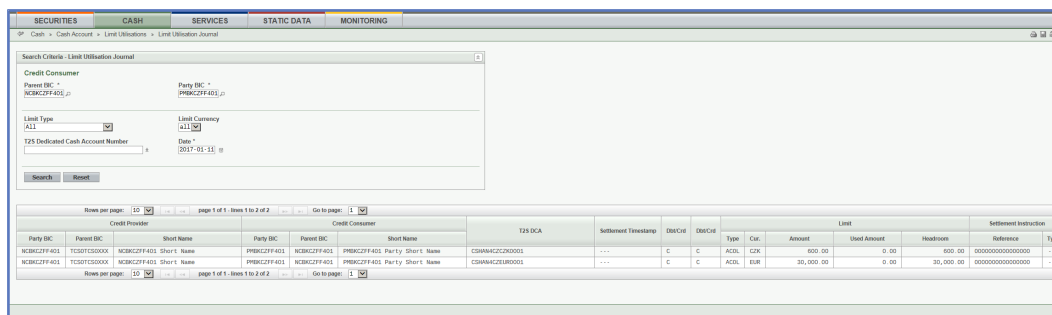

Illustration 74: Limit utilisation journal – search/list screen

Field Description

Limit Utilisation Journal – Search Criteria	
Credit Consumer	
Party BIC*	Select the BIC of the party from the drop-down menu or search via the <i>magnifier</i> icon. Required format is: max. 11 characters (SWIFT-x)
Parent BIC*	Select the parent BIC of the party from the drop-down menu or search via the <i>magnifier</i> icon. Required format is: max. 11 characters (SWIFT-x)
Limit Type	Select the limit type from one of the possible values: <ul style="list-style-type: none"> <input type="checkbox"/> All (default value) <input type="checkbox"/> EXGT (External Guarantee) <input type="checkbox"/> ACOL (Auto-collateralisation)

Limit Utilisation Journal – Search Criteria	
	<input type="checkbox"/> UCDT (Unsecured Credit)
Limit Currency	Select the currency of the T2S dedicated cash account from the drop-down menu. The default value is 'all'.
T2S Dedicated Cash Account Number	Select the number of the T2S dedicated cash account from the drop-down menu. Required format is: max. 34 characters (SWIFT-x) If there is only one possible account, this field is already filled in. Reference for error message: [▶ 1369] <input type="checkbox"/> QMPC031
Date*	Enter the date of the limit utilisation or use the <i>calendar</i> icon. Required format is: YYYY-MM-DD. The default value is the current business date. It has to be a valid business date less than or equal to the current business date. Reference for error message: [▶ 1369] <input type="checkbox"/> QMPC055
Limit Utilisation Journal – List	
Credit Provider	
Party BIC	Shows the BIC of the credit provider.
Parent BIC	Shows the parent BIC of the credit provider.
Short Name	Shows the party short name of the credit provider.
Credit Consumer	
Party BIC	Shows the BIC of the credit consumer.
Parent BIC	Shows the parent BIC of the credit consumer.
Short Name	Shows the party short name of the credit consumer.
T2S Dedicated Cash Account Number	Shows the number of the T2S dedicated cash account relating to the journal of limit utilisation. Reference for error message: [▶ 1369] <input type="checkbox"/> QMPC031
Settlement Timestamp	Shows the timestamp of the limit utilisation. Displayed format is: YYYY-MM-DD hh:mm:ss:µsµsµsµsµs

Limit Utilisation Journal – Search Criteria	
Debit/Credit Indicator	Show the debit credit indicator of the limit from the possible values: <input type="checkbox"/> D (Debit) <input type="checkbox"/> C (Credit)
Limit	
Limit Type	Shows the type of the limit from one of the possible values: <input type="checkbox"/> EXGT (External Guarantee) <input type="checkbox"/> ACOL (Auto-collateralisation) <input type="checkbox"/> UCDT (Unsecured Credit)
Currency	Shows the currency of the T2S dedicated cash account.
Amount	Shows the amount of the limit.
Used amount	Shows the amount of the limit after this utilisation.
Headroom	Shows the headroom of the limit.
Settlement Instruction	
Reference	Shows the reference of the settlement instruction related to the utilisation journal entry.
Instruction Type	Shows the type of the settlement instruction related to the utilisation journal entry.

Buttons

Search	This function enables you to start a search according to the criteria entered. The results are displayed in a list on the same screen. Next screen: <input type="checkbox"/> <i>Limit utilisation journal – search/list</i> screen References for error messages: [▶ 1369] <input type="checkbox"/> QMPC031 <input type="checkbox"/> QMPC055
Reset	This function enables you to set default search criteria and blanks out all optional criteria. Next screen: <input type="checkbox"/> <i>Limit utilisation journal – search/list</i> screen

2.3.1.10 T2S DCA Balances - Search/List Screen

Context of Usage

This screen contains a number of search fields. By inputting the relevant data, you can search for T2S dedicated cash account balances. The search results will be displayed in a list, which is sorted by the value of the 'T2S Dedicated Cash Account Number' column in ascending order (default setting). After selecting one entry, you can further proceed by clicking on the buttons below.

When exporting the content of this screen, you receive the list and the corresponding details for each data record.

During the Start of Day, when the CRDM data is being replicated in the Settlement domain, only the cash balances data available at the End-of-Day of the previous business day is displayed at the screen. The cash balances data for the new business day is available as of the end of the CRDM data replication.{CR-634}

During night-time, the cash balances can only be displayed in-between night-time settlement sequences.

This screen is not relevant for CSD or CSD participant users.

Screen Access

- Cash >> Cash Account >> Cash Account Balances
- Monitoring >> Monitoring >> Cash Account Balances

Privileges

To use this screen, you need the following privilege [▶ 1233]:

- T2S dedicated cash account balance query

References

User Instructions Part

This screen is part of the following business scenarios:

- View cash balances details and related postings [▶ 714]
- View cash balances details and related restrictions [▶ 715]

Business Functionality Document

This screen corresponds to the following business functions:

- Query T2S dedicated cash account balances (T2S.GUI.LMSE.CSH.0010)
- Display T2S dedicated cash account balances (T2S.GUI.LMSE.CSH.0020)

Screenshot

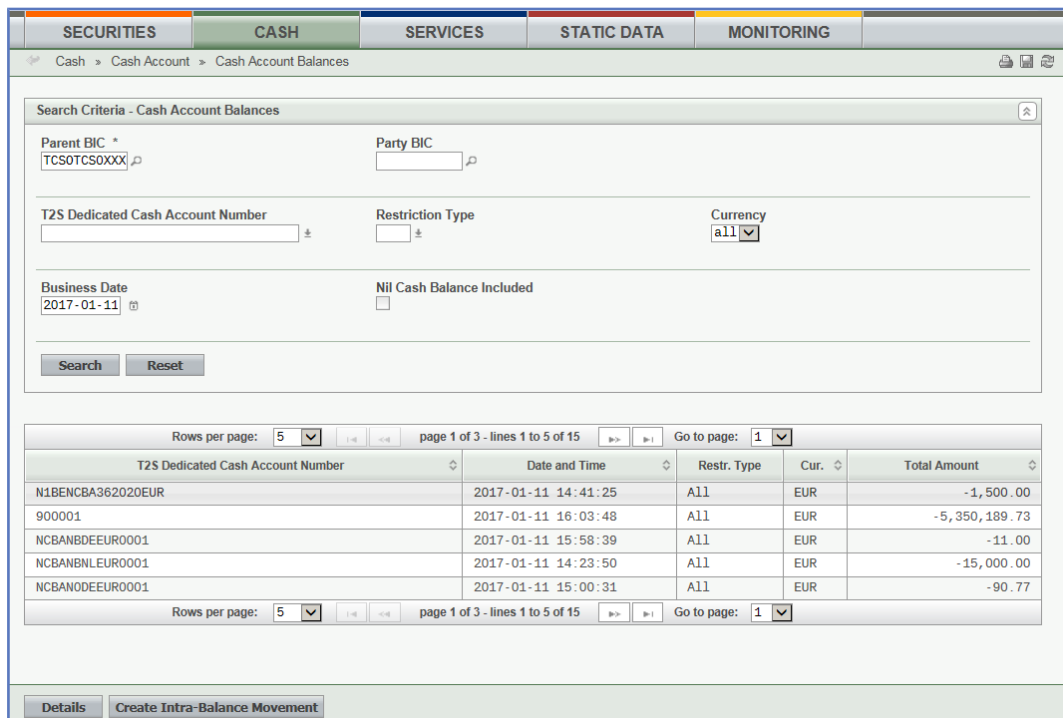

Illustration 75: T2S DCA balances – search/list screen

Field Description

Cash Balances – Search Criteria	
Party BIC*	<p>Select the BIC of the party owning the cash balances you want to retrieve from the drop-down menu or search via the <i>magnifier</i> icon.</p> <p>You have to enter at least one field among ‘Party BIC’ and ‘Date’.</p> <p>References for error messages [▶ 1449]:</p> <ul style="list-style-type: none"> <input type="checkbox"/> QMPC032 <input type="checkbox"/> QMPC072 <input type="checkbox"/> QMPC084
Parent BIC*	<p>Select the parent BIC of the CB where the above party holds the cash balances you want to retrieve from the drop-down menu.</p> <p>References for error messages [▶ 1449]:</p> <ul style="list-style-type: none"> <input type="checkbox"/> QMPC048 <input type="checkbox"/> QMPC072 <input type="checkbox"/> QMPC084

Cash Balances – Search Criteria	
T2S Dedicated Cash Account Number	<p>Select the number of the T2S dedicated cash account from the drop-down menu.</p> <p>If there is only one possible cash account, this field is read-only.</p> <p>References for error message [▶ 1449]:</p> <ul style="list-style-type: none"> <input type="checkbox"/> QMPC031 <input type="checkbox"/> QMPC072
Restriction Type	<p>Select a restriction type of the cash balance.</p> <p>If you select the value 'All', all cash balances are displayed in the list.</p> <p>Reference for error message [▶ 1449]:</p> <ul style="list-style-type: none"> <input type="checkbox"/> QMPC091
Currency	<p>Select the currency of the T2S dedicated cash account from the drop-down menu. The default value is 'all'.</p> <p>References for error messages [▶ 1449]:</p> <ul style="list-style-type: none"> <input type="checkbox"/> QMPC054 <input type="checkbox"/> QMPC072
Date	<p>Enter the date of T2S dedicated cash account balance or use the <i>calendar</i> icon.</p> <p>Required format is: YYYY-MM-DD</p> <p>You have to enter at least one field among 'Party BIC' and 'Date'.</p> <p>The default value is the current business day.</p> <p>The 'Date' must be a valid business date which is earlier than or equal to the current business date.</p> <p>Reference for error message [▶ 1449]:</p> <ul style="list-style-type: none"> <input type="checkbox"/> QMPC073
Nil Cash Balance Included	<p>Select whether the T2S dedicated cash balances equal to zero are included.</p>
Multiple Cash Balances - List	
T2S Dedicated Cash Account Number	<p>Shows the number of the T2S dedicated cash account of the cash balance.</p> <p>Reference for error message [▶ 1449]:</p> <ul style="list-style-type: none"> <input type="checkbox"/> QMPC072

Cash Balances – Search Criteria	
Date and Time	Shows the date and time of the cash balance (or the closest previous date and time). Displayed format is: YYYY-MM-DD hh:mm:ss:µsµsµsµsµs
Restriction Type	Shows the restriction type of the cash balance. Reference for error message [▶ 1449]: <input type="checkbox"/> QMPC091
Currency	Shows the currency of the T2S dedicated cash account. References for error messages [▶ 1449]: <input type="checkbox"/> QMPC054 <input type="checkbox"/> QMPC072
Total Amount	Shows the total amount of the cash balance. Provision of '99999...99' in case oversizing occurs in the integer part. Truncation of decimals in case oversizing occurs in the decimal part.

Buttons

Search	This function enables you to start a search according to the criteria entered. The results are displayed in a list on the same screen. If the search retrieves a single record, the <i>details</i> screen is displayed directly. Next screens: <input type="checkbox"/> T2S DCA balances - search/list screen <input type="checkbox"/> T2S DCA balance – details screen [▶ 362] References for error messages [▶ 1449]: <input type="checkbox"/> QMPC031 <input type="checkbox"/> QMPC032 <input type="checkbox"/> QMPC048 <input type="checkbox"/> QMPC054 <input type="checkbox"/> QMPC072 <input type="checkbox"/> QMPC073 <input type="checkbox"/> QMPC084 <input type="checkbox"/> QMPC091

Reset	This function enables you to set default search criteria and blanks out all optional criteria. Next screen: <input type="checkbox"/> <i>T2S DCA balances - search/list</i> screen
Details	This function enables you to display the details of the selected cash balance. Next screen: <input type="checkbox"/> <i>T2S DCA balance - details</i> screen [▶ 362]
Create Intra-Balance Movement	This function enables you to create a new restricted cash balance for the selected T2S dedicated cash account number. Next screen: <input type="checkbox"/> <i>Intra-balance movement – new</i> screen [437]

2.3.1.11 T2S DCA Balance - Details Screen

Context of Usage

This screen displays detailed information on the cash balances for a T2S dedicated cash account owner, i.e. a party which is a payment or central bank. You can check the data and proceed further by clicking on the buttons below.

During the Start of Day, when the CRDM data is being replicated in the Settlement domain, only the cash balance data available at the End-of-Day of the previous business day is displayed at the screen. The cash balance data for the new business day is available as of the end of the CRDM data replication.

During night-time, the cash balances can only be displayed in-between night-time settlement sequences.{CR-634}

This screen is not relevant for CSD or CSD participant users.

Screen Access

- Cash >> Cash Account >> Cash Account Balances >> *T2S DCA balances – search/list* screen >> Click on the *search* and/or *details* button
- Cash >> Settlement >> Intra-Balance Movements >> *Intra-balance movements – search/list* screen >> Click on the *search* and/or *details* button >> *Intra-balance movement – details* screen >> Click on the *cash balance details* button

Privileges

No privilege needed to use this screen.

References

User Instructions Part

This screen is part of the following business scenarios:

- View cash balances details and related postings [▶ 714]
- View cash balances details and related restrictions [▶ 715]

Business Functionality Document

This screen corresponds to the following business functions:

- Display T2S dedicated cash account balances (T2S.GUI.LMSE.CSH.0020)

Screenshot

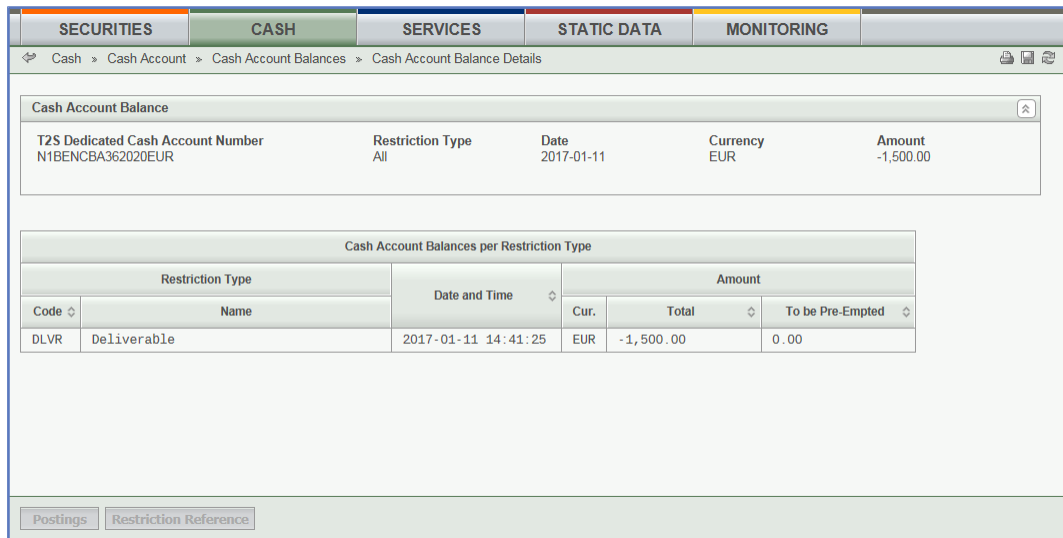

Illustration 76: T2S dedicated cash account balance – details screen

Field

Description

Identification of Cash Balances	
T2S Dedicated Cash Account Number	Shows the number of the T2S dedicated cash account.
Restriction Type	Shows the restriction type of the cash balance.
Currency	Shows the currency of the T2S dedicated cash account.
Total Amount	Shows the total amount of cash for the aggregated cash balances. Provision of '99999...99' in case oversizing occurs in the integer part. Truncation of decimals in case oversizing occurs in the decimal part.
Cash Balance per Restriction Type	
Restriction Type	
Code	Shows the code of the restriction type of the cash balance.
Name	Shows the name of the restriction type of the cash balance.
Date and Time	Shows the date and time of the last movement related to the cash balance. Displayed format is: YYYY-MM-DD hh:mm:ss:µsµsµsµsµsµs

Identification of Cash Balances	
Amount	
Currency	Shows the currency related to the T2S dedicated cash account.
Total	Shows the total amount of the cash balance. Provision of '99999...99' in case oversizing occurs in the integer part. Truncation of decimals in case oversizing occurs in the decimal part.
To be Pre-Empted	Shows the amount of the cash balance that is to be pre-empted. Provision of '99999...99' in case oversizing occurs in the integer part. Truncation of decimals in case oversizing occurs in the decimal part.

Buttons

Postings	This function enables you to display the cash postings for the selected cash balance. Next screen: <input type="checkbox"/> <i>T2S DCA postings – search/list screen [364]</i>
Restrictions References	This function enables you to display the details per restriction reference for the selected cash balance. Next screen: <input type="checkbox"/> <i>Cash restriction details – search/list screen [338]</i>

2.3.1.12 T2S DCA Postings - Search/List Screen

Context of Usage

This screen contains a number of search fields. By inputting the relevant data, you can search for cash postings which are the individual debits and credits impacting the selected cash balance. The search results will be displayed in a list, which is sorted either by the values of the 'T2S Dedicated Account Number', 'Restriction Type', 'Date', 'Debit/Credit', 'Currency', 'Amount', 'Instruction Type', 'Internal Reference', 'Restriction Reference' or 'Date and Time' columns in ascending order (default setting).

After selecting an entry, you can proceed further by clicking on the buttons below.

[During night-time, the T2S DCA postings can only be displayed in-between night-time settlement sequences.](#){CR-634}

This screen is not relevant for CSD or CSD participant users.

- Screen Access**
- Cash >> Cash Account >> Cash Account Postings
 - Cash >> Cash Account >> Cash Account Balances >> **T2S DCA balances – search/list screen** >> Click on the *search* and/or *details* button >> **T2S DCA balance – details screen** >> Click on the *postings* button

Privileges To use this screen, you need the following privilege [**▶ 1233**]:

- T2S dedicated cash account posting query

References **User Instructions Part**

This screen is part of the following business scenario:

- View cash balances details and related postings [**▶ 714**]

Business Functionality Document

This screen corresponds to the following business functions:

- Query T2S dedicated cash account postings (T2S.GUI.LMSE.CSH.0030)
- Display T2S dedicated cash account postings (T2S.GUI.LMSE.CSH.0040)

Screenshot

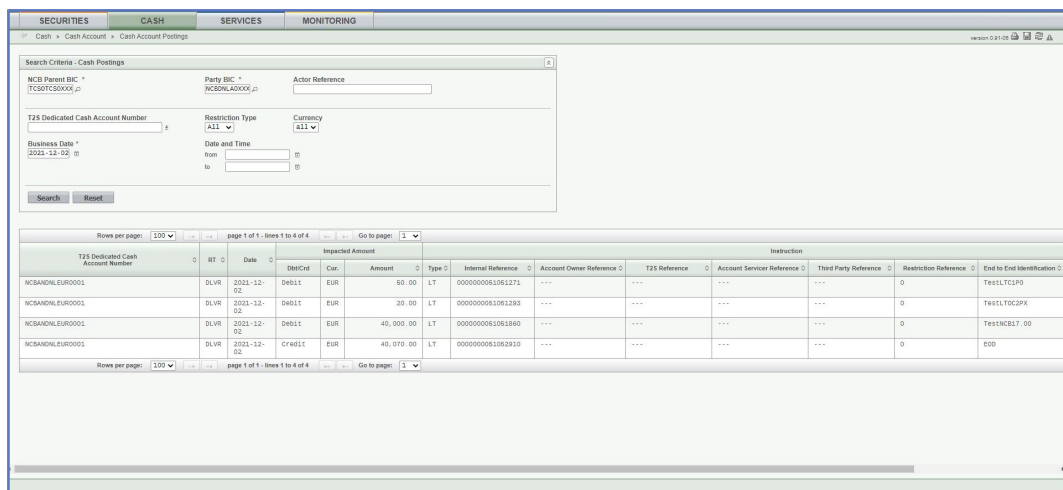

Illustration 77: T2S DCA postings – search/list screen

Field Description

Cash Postings - Search Criteria	
Actor Reference	<p>You can choose to enter one of the following references depending on whether you are querying on cash movements related to a settlement instruction or a liquidity transfer:</p> <ul style="list-style-type: none"> <input type="checkbox"/> For a settlement instruction: <ul style="list-style-type: none"> <input type="checkbox"/> Account Owner Reference <input type="checkbox"/> Account Servicer Reference <input type="checkbox"/> T2S Reference <input type="checkbox"/> Third Party Reference <input type="checkbox"/> For a liquidity transfer:

Cash Postings - Search Criteria	
	<ul style="list-style-type: none"> <input type="checkbox"/> End to End Identification <input type="checkbox"/> Technical Identifier of LT <p>If you fill in the Actor Reference, only Liquidity transfers or Settlement instructions related to this reference are returned,</p> <p>When the Actor reference is not found in SI or LT, the message “No record found” is displayed.</p>
Party BIC*	<p>You can choose to either enter the BIC of the party owning the cash account or to select it from the suggested items in the drop-down menu.</p> <p>If you have accessed this screen via the T2S DCA balance – details screen, this field is already filled in.</p> <p>References for error messages [▶ 1450]:</p> <ul style="list-style-type: none"> <input type="checkbox"/> QMPC032 <input type="checkbox"/> QMPC072
NCB Parent BIC*	<p>You can choose to either enter the BIC of the CB where the above party holds the cash account or to select it from the suggested items in the drop-down menu. If you have accessed this screen via the T2S DCA balance – details screen, this field is already filled in.</p> <p>Reference for error message [▶ 1450]:</p> <ul style="list-style-type: none"> <input type="checkbox"/> QMPC072
T2S Dedicated Cash Account Number	<p>Select the number of the T2S dedicated cash account from the drop-down menu. The default value is ‘All’.</p> <p>If there is only one possible cash account, this field is read-only.</p> <p>If you have accessed this screen via the T2S DCA balance – details screen, this field is already filled in.</p> <p>Reference for error message [▶ 1450]:</p> <ul style="list-style-type: none"> <input type="checkbox"/> QMPC072
Restriction Type	<p>You can choose to either enter the restriction type of the cash posting or to select it from the suggested items in the drop-down menu.</p>

Cash Postings - Search Criteria	
	<p>If you select the value 'All', the postings of all restriction types are displayed in the list.</p> <p>If you have accessed this screen via the T2S DCA balance – details screen, this field is already filled in.</p> <p>Reference for error message [▶ 1450]:</p> <ul style="list-style-type: none"> <input type="checkbox"/> QMPC091
Currency	<p>Select the currency of the T2S dedicated cash account from the drop-down menu. The default value is 'All'.</p> <p>If you have accessed this screen via the T2S DCA balance – details screen, this field is already filled in.</p> <p>References for error messages [▶ 1450]:</p> <ul style="list-style-type: none"> <input type="checkbox"/> QMPC054 <input type="checkbox"/> QMPC072
Date*	<p>Enter the date of the cash postings or use the <i>calendar</i> icon.</p> <p>The default value is the current business day.</p> <p>Required format is: YYYY-MM-DD</p> <p>The 'Date' must be a valid business date earlier than or equal to the current business date.</p> <p>If you have accessed this screen via the T2S DCA balance – details screen, this field is already filled in.</p> <p>References for error messages [▶ 1450]:</p> <ul style="list-style-type: none"> <input type="checkbox"/> QMPC016 <input type="checkbox"/> QMPC073
Date and Time from	<p>Enter the starting date and time of the cash postings or use the <i>calendar</i> icon.</p> <p>Required format is: YYYY-MM-DD hh:mm</p> <p>The 'Date and Time from' must be a valid business date earlier than or equal to the current business date and time.</p> <p>Reference for error message [▶ 1450]:</p> <ul style="list-style-type: none"> <input type="checkbox"/> QMPC073
Date and Time to	<p>Enter the ending date and time of the cash postings or use the <i>calendar</i> icon.</p> <p>Required format is: YYYY-MM-DD hh:mm</p>

Cash Postings - Search Criteria	
	The 'Date and Time to' must be a valid business date earlier than or equal to the current business date and time. The date and time must be equal to or later than the 'Date and Time from'.
Cash Postings - List	
T2S Dedicated Cash Account Number	Shows the number of the T2S dedicated cash account of the cash posting. Reference for error message [▶ 1450]: <input type="checkbox"/> QMPC072
Restriction Type	Shows the restriction type of the cash posting. Reference for error message [▶ 1450]: <input type="checkbox"/> QMPC091
Date	Shows the date of the cash posting. Displayed format is: YYYY-MM-DD References for error messages [▶ 1450]: <input type="checkbox"/> QMPC016 <input type="checkbox"/> QMPC073
Impacted Amount	
Debit/Credit Indicator	Shows the debit/credit indicator related to the cash posting from the possible values: <input type="checkbox"/> D (for debit) <input type="checkbox"/> C (for credit)
Currency	Shows the currency of the T2S dedicated cash account. References for error messages [▶ 1450]: <input type="checkbox"/> QMPC054 <input type="checkbox"/> QMPC072
Amount	Shows the amount of the cash posting.
Instruction	
Account Owner Reference	Shows the Account Owner Transaction Identification of the instruction related to the cash posting.
T2S Reference	Shows the Market Infrastructure Transaction Identification of the instruction related to the cash posting.
Account Servicer Reference	Shows the Account Servicer Transaction Identification of the instruction related to the cash posting

Cash Postings - Search Criteria	
Third Party Reference	Shows the Processing Identification of the instruction related to the cash posting.
End to End Id	Shows the End to End Identification of the Liquidity Transfer related to the cash posting.
Technical Id	Shows the Technical Identifier of the Liquidity Transfer related to the cash posting.
Type	Shows the type of instruction related to the cash posting from the possible values: <ul style="list-style-type: none"> <input type="checkbox"/> LT (for liquidity transfer) <input type="checkbox"/> SI (for settlement instruction) <input type="checkbox"/> SR (for settlement restriction)
Internal Reference	Shows the T2S internal reference of the instruction related to the cash posting.
Restriction Reference	Shows the restriction reference related to the cash posting.
Date and Time	Shows the date and time of the cash posting. Displayed format is: YYYY-MM-DD hh:mm:ss:µsµsµsµsµs

Buttons

Buttons	
Search	<p>This function enables you to start a search according to the criteria entered. The results are displayed in a list on the same screen.</p> <p>Next screen:</p> <ul style="list-style-type: none"> <input type="checkbox"/> <i>T2S DCA postings – search/list</i> screen <p>References for error messages [▶ 1450]:</p> <ul style="list-style-type: none"> <input type="checkbox"/> QMPC016 <input type="checkbox"/> QMPC032 <input type="checkbox"/> QMPC054 <input type="checkbox"/> QMPC072 <input type="checkbox"/> QMPC073 <input type="checkbox"/> QMPC091
Reset	<p>This function enables you to set default search criteria and blanks out all optional criteria.</p> <p>Next screen:</p> <ul style="list-style-type: none"> <input type="checkbox"/> <i>T2S DCA postings – search/list</i> screen

2.3.1.13 Total Collateral Values per T2S Dedicated Cash Account - Search/List Screen

Context of Usage

This screen contains a number of search fields. By inputting the relevant data, you can search for the total collateral value of securities on stock which are eligible for auto-collateralisation for those T2S dedicated cash accounts that match the specified selection criteria. The search results will be displayed in a list, which is sorted by the values of the 'Party BIC' column in ascending order (default setting). After selecting an entry, you can proceed further by clicking on the buttons below.

During the Start of Day, when the CRDM data is being replicated in the Settlement domain, only the total collateral value per T2S dedicated cash account data available at the End-of-Day of the previous business day is displayed at the screen. The total collateral value per T2S dedicated cash account data for the new business day is available as of the end of the CRDM data replication.{CR-634}

The screen can be used in the following contexts:

- CB users (CB as credit provider) can view the total collateral value of securities associated to the T2S dedicated cash accounts of their payment banks. This is the collateral value that payments banks can use as a guarantee for central bank collateralisation.
- Payment bank users (payment bank as credit consumer) can view the total collateral value of their own securities associated to their T2S dedicated cash accounts. This is the collateral value that the payment bank can use as a guarantee for central bank collateralisation.
- Payment bank users (payment bank as credit provider) can view the total collateral value of the clients' securities associated to the payment bank's T2S dedicated cash accounts. This is the collateral value that the payment bank's clients can use as a guarantee for client collateralisation.
- Payment bank client users (payment bank client as credit consumer) can view the total collateral value of their securities associated to the T2S dedicated cash account of their payment bank. This is the collateral value that the payment bank's client can use as a guarantee for client collateralisation.

There is no usage restriction for this screen.

Screen Access

- Cash >> Cash Account >> Total Collateral Values (T2S DCA)
- Securities >> Securities Account >> Total Collateral Values (T2S DCA)

Privileges

To use this screen, you need the following privilege [[▶ 1234](#)]:

- Total collateral value per T2S dedicated cash account query

References

User Instructions Part

This screen is not part of a business scenario.

Business Functionality Document

This screen corresponds to the following business functions:

- Query total current collateral value (per T2S dedicated cash account) (T2S.GUI.LMSE.CSH.0090)
- Display total current collateral value (per T2S dedicated cash account) (T2S.GUI.LMSE.CSD.0100)

Screenshot

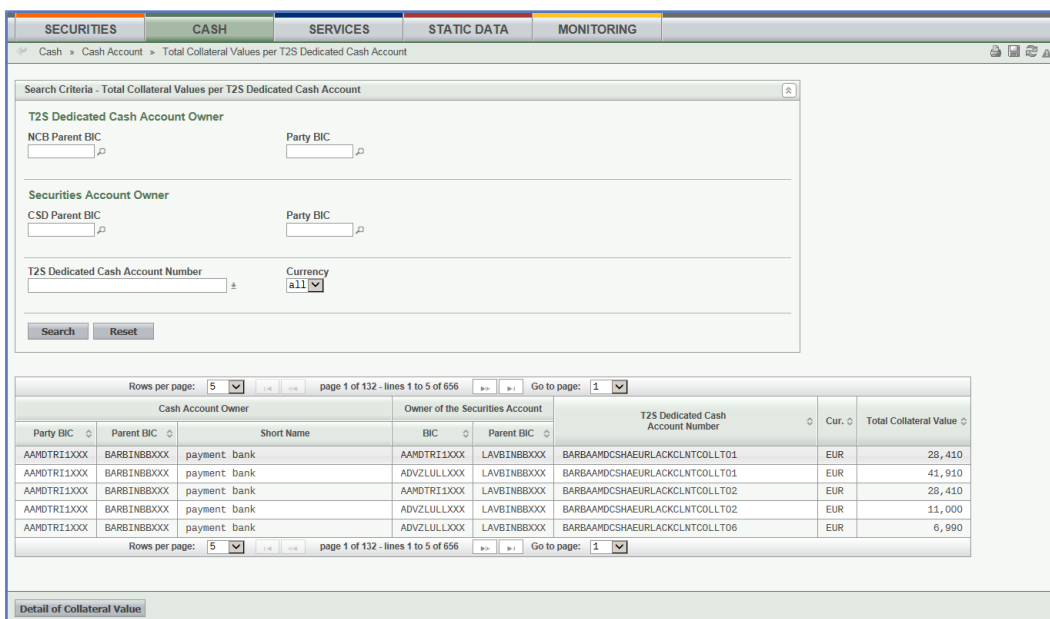

Illustration 78: Total collateral value per T2S dedicated cash account – search/list screen

Field Description

Total Collateral Value per T2S Dedicated Cash Account - Search Criteria	
T2S Dedicated Cash Account Owner	
Party BIC	Select the BIC of the party owning the T2S dedicated cash account from the drop-down menu or search via the <i>magnifier</i> icon. Reference for error message: [1452] <input type="checkbox"/> QMPC032
NCB Parent BIC	Select the BIC of the national central bank which is the parent of the party owning the T2S dedicated cash account from the drop-down menu or search via the <i>magnifier</i> icon. Reference for error message: [1452] <input type="checkbox"/> QMPC032
Securities Account Owner	

Total Collateral Value per T2S Dedicated Cash Account - Search Criteria	
Party BIC	Select the BIC of the party owning the securities account from the drop-down menu or search via the <i>magnifier</i> icon. References for error messages: [▶ 1452] <input type="checkbox"/> QMPC032 <input type="checkbox"/> QMPC084
CSD Parent BIC	Select the BIC of the CSD which is the parent of the party owning the securities account from the drop-down menu or search via the <i>magnifier</i> icon. References for error messages: [▶ 1452] <input type="checkbox"/> QMPC032 <input type="checkbox"/> QMPC084
T2S Dedicated Cash Account Number	Select the number of the T2S dedicated cash account from the drop-down menu. If there is only one possible T2S dedicated cash account for your privileges, this field is already filled in. Reference for error message: [▶ 1452] <input type="checkbox"/> QMPC031
Currency	Select the currency of the T2S dedicated cash account(s) from the drop-down menu. The default value is 'all'. Reference for error message: [▶ 1452] <input type="checkbox"/> QMPC054
Total Collateral Value per T2S Dedicated Cash Account - List	
Cash account owner	
Party BIC	Shows the BIC of the party owning the T2S dedicated cash account. Reference for error message: [▶ 1452] <input type="checkbox"/> QMPC032
Parent BIC	Shows the BIC of the national central bank which is the parent of the party owning the T2S dedicated cash account. Reference for error message: [▶ 1452] <input type="checkbox"/> QMPC032
Party Short Name	Shows the short name of the party owning the T2S dedicated cash account.

Total Collateral Value per T2S Dedicated Cash Account - Search Criteria	
T2S Dedicated Cash Account Number	Shows the number of the T2S dedicated cash account. Reference for error message: [1452] <input type="checkbox"/> QMPC031
Currency	Shows the currency of the T2S dedicated cash account. Reference for error message: [1452] <input type="checkbox"/> QMPC054
Securities Account Owner	
Party BIC	Shows the BIC of the securities account owner of the securities account that holds the valuated securities
Parent BIC	Shows the parent BIC of the securities account owner
Total Collateral Value	Shows the collateral value of the aggregated securities positions per T2S dedicated cash account. Provision of '99999...99' in case oversizing occurs in the integer part. Truncation of decimals in case oversizing occurs in the decimal part.

Buttons

Buttons	
Search	This function enables you to start a search according to the criteria entered. The results are displayed in a list on the same screen. If the search retrieves a single record, the <i>details</i> screen is displayed directly. References for error messages: [1452] <input type="checkbox"/> QMPC031 <input type="checkbox"/> QMPC032 <input type="checkbox"/> QMPC054 <input type="checkbox"/> QMPC084 Next screens: <input type="checkbox"/> <i>Total collateral value per T2S dedicated cash account – search/list</i> screen <input type="checkbox"/> <i>Collateral value per T2S dedicated cash account and security – search/list</i> screen [345]
Reset	This function enables you to set default search criteria and blanks out all optional criteria. Next screen:

	<input type="checkbox"/> <i>Total collateral value per T2S dedicated cash account – search/list screen</i>
Detail of Collateral Value	<p>This function enables you to display the details of the collateral value for the selected T2S dedicated cash account.</p> <p>Next screen:</p> <input type="checkbox"/> <i>Collateral value per T2S dedicated cash account and security – search/list screen [▶ 345]</i>

2.3.2 Liquidity

2.3.2.1 Data Changes - Search/List Screen

See *Data Changes – Search/List Screen* [▶ 608].

2.3.2.2 Data Change - Details Screen

See *Data Changes – Details Screen* [▶ 612].

2.3.2.3 Immediate Liquidity Transfers - Search/List Screen

Context of Usage

This screen contains a number of search fields. By inputting the relevant data, you can search for immediate liquidity transfer orders. The search results will be displayed in a list. If you search via 'Parent BIC' or 'Party BIC', the list will be sorted by the values of the 'T2S Dedicated Cash Account Number' column in ascending order (default setting). If you search via another search parameter, the list will be sorted by the values of the 'Settlement Date and Time' column in ascending order (default setting). After the initial sorting, you have the possibility to rearrange the list according to your preferences by selecting another 'Sort by'. After selecting an entry, you can proceed further by clicking on the buttons below.

This screen is not relevant for CSD, CSD participants and external CSD users.

Screen Access

Cash >> Liquidity >> Immediate Liquidity Transfers

Privileges

To use this screen, you need the following privileges [▶ 1214]:

- Immediate liquidity transfer order list query
- Immediate liquidity transfer order detail query

References

User Instructions Part

This screen is part of the following business scenarios:

- Create a new immediate liquidity transfer order

- Copy an immediate liquidity transfer order [▶ 712]
- View immediate liquidity transfer order details [▶ 716]

Business Functionality Document

This screen corresponds to the following business functions:

- Query immediate liquidity transfer instructions (T2S.GUI.LMSE.INX.0010)
- Display immediate liquidity transfer instructions list (T2S.GUI.LMSE.INX.0020)

Screenshot

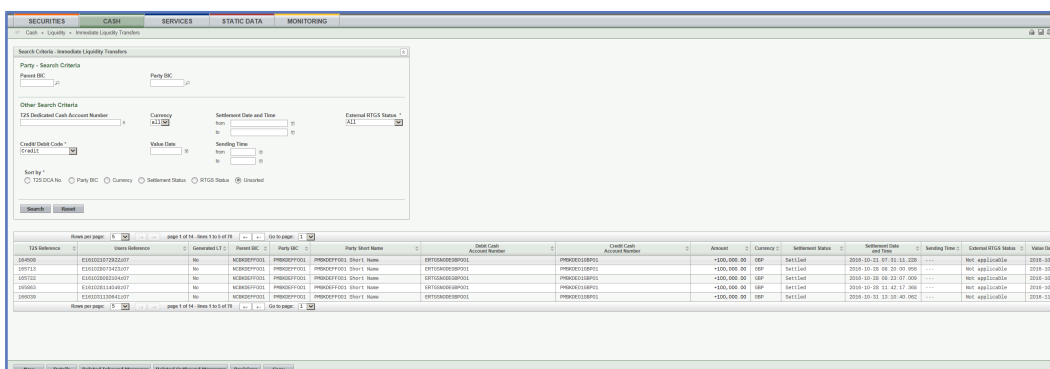

Illustration 79: Immediate liquidity transfer orders - search/list screen

Field Description

Immediate Liquidity Transfer Orders – Search Criteria	
Party	
Parent BIC	Select the parent BIC of the party. References for error messages [▶ 1318]: <input type="checkbox"/> QMPC072 <input type="checkbox"/> QMPC084
Party BIC	Select the BIC of the party. References for error messages [▶ 1318]: <input type="checkbox"/> QMPC032 <input type="checkbox"/> QMPC072 <input type="checkbox"/> QMPC084
Other Search Criteria	
T2S Dedicated Cash Account Number	Select the T2S dedicated cash account which has been debited or credited from the drop-down menu. The default value is 'All'. References for error messages [▶ 1318]: <input type="checkbox"/> QMPC031 <input type="checkbox"/> QMPC072

Immediate Liquidity Transfer Orders – Search Criteria	
	If you have the privilege for only one T2S dedicated cash account, this field is already filled in.
Debit/Credit Indicator*	<p>Select the credit/debit code from the possible values:</p> <ul style="list-style-type: none"> <input type="checkbox"/> Credit <input type="checkbox"/> Credit and Debit (default value) <input type="checkbox"/> Debit <p>Select credit if you want to search for liquidity transfer orders which have credited a T2S dedicated cash account.</p> <p>Select debit if you want to search for liquidity transfer orders which have debited a T2S dedicated cash account.</p>
Currency	<p>Select the currency assigned to the T2S dedicated cash account from the drop-down menu. The default value is 'all'.</p> <p>References for error messages [▶ 1318]:</p> <ul style="list-style-type: none"> <input type="checkbox"/> QPMC054 <input type="checkbox"/> QPMC072 <p>If you have first selected the 'T2S Dedicated Cash Account Number', this field is already filled in.</p>
Settlement Date and Time - from	<p>Enter the date and time from which the liquidity transfer is settled or use the <i>calendar</i> icon.</p> <p>Required format is: YYYY-MM-DD hh:mm:ss</p> <p>References for error messages [▶ 1318]:</p> <ul style="list-style-type: none"> <input type="checkbox"/> QMPC015 <input type="checkbox"/> QMPC016 <p>The 'Settlement Date and Time – from' cannot be earlier than 90 days before the current business day and must be earlier than or equal to the 'Settlement Date and Time – to'.</p>
Settlement Date and Time - to	<p>Enter the date and time until which the liquidity transfer is settled or use the <i>calendar</i> icon.</p> <p>Required format is: YYYY-MM-DD hh:mm:ss</p> <p>References for error messages [▶ 1318]:</p> <ul style="list-style-type: none"> <input type="checkbox"/> QMPC015 <input type="checkbox"/> QMPC016

Immediate Liquidity Transfer Orders – Search Criteria	
	<input type="checkbox"/> QMPC097 The 'Settlement Date and Time - to' cannot be earlier than 90 days before the current business day and must be earlier than or equal to the current business day.
Value Date	Enter the value date of the liquidity transfer or use the <i>calendar</i> icon. Required format is: YYYY-MM-DD The 'Value Date' cannot be earlier than 90 days before the current business day or later than the current business day. If you do not select a date, this field is filled in with the current business day.
Sending Time - from	Enter the time from which the outbound liquidity transfer was sent to the RTGS. Required format is: hh:mm:ss
Sending Time - to	Enter the time until which the outbound liquidity transfer was sent to the RTGS. Required format is: hh:mm:ss
External RTGS Status*	Select the external RTGS status from the possible values: <ul style="list-style-type: none"> <input type="checkbox"/> Not executed <input type="checkbox"/> Not applicable (default value) <input type="checkbox"/> RTGS rejection <input type="checkbox"/> RTGS confirmation <input type="checkbox"/> Rebooking
Sort by	Select the category by which you want to sort the list from the possible values: <ul style="list-style-type: none"> <input type="checkbox"/> T2S DCA No. (default value if you have searched via 'Parent BIC' or 'Party BIC') <input type="checkbox"/> Party BIC <input type="checkbox"/> Currency <input type="checkbox"/> Settlement status <input type="checkbox"/> External RTGS status

Immediate Liquidity Transfer Orders – Search Criteria	
	<input type="checkbox"/> Unsorted (Default value if you have searched via the other search parameters. Unsorted means that the list is sorted by the values of the ‘Settlement Date and Time’ column.)
Immediate Liquidity Transfer Orders - List ¹⁵	
T2S Dedicated Cash Account Number	<p>Shows the T2S dedicated cash account which has been debited or credited.</p> <p>References for error messages [▶ 1318]:</p> <ul style="list-style-type: none"> <input type="checkbox"/> QMPC031 <input type="checkbox"/> QMPC072 <p>If you sort the list by that value, the screen is divided into different sections grouped by T2S dedicated cash account numbers.</p>
Party BIC	<p>Shows the BIC of the party.</p> <p>References for error messages [▶ 1318]:</p> <ul style="list-style-type: none"> <input type="checkbox"/> QMPC032 <input type="checkbox"/> QMPC072 <input type="checkbox"/> QMPC084 <p>If you sort the list by that value, the screen is divided into different sections grouped by party.</p>
Currency	<p>Shows the currency of the amount to be transferred.</p> <p>References for error messages [▶ 1318]:</p> <ul style="list-style-type: none"> <input type="checkbox"/> QPMC054 <input type="checkbox"/> QPMC072 <p>If you sort the list by that value, the screen is divided into different sections grouped by currency.</p>
Settlement Status	<p>Shows the settlement status of liquidity transfers.</p> <p>If the liquidity transfer is internal or outbound, it shows the settlement status from the possible values:</p> <ul style="list-style-type: none"> <input type="checkbox"/> Not executed (SNXE) <input type="checkbox"/> Unsettled (SUNS) <input type="checkbox"/> Partially settled (SPAS) <input type="checkbox"/> Settled (SSET)

15 Please note that the described functionality won't be available before CSLD go-live.

Immediate Liquidity Transfer Orders – Search Criteria	
	<p>If the liquidity transfer is inbound, it shows the settlement status from the possible values:</p> <ul style="list-style-type: none"> <input type="checkbox"/> Not executed <input type="checkbox"/> Settled <p>If you sort the list by that value, the screen is divided into different sections grouped by settlement status.</p>
External RTGS Status	<p>Shows the external RTGS status of the liquidity transfer from the possible values:</p> <ul style="list-style-type: none"> <input type="checkbox"/> Not executed (RNXE) <input type="checkbox"/> Not applicable (RNAP) <input type="checkbox"/> RTGS rejection (RREJ) <input type="checkbox"/> RTGS confirmation (RCON) <p>If the liquidity transfer is internal, this field is always filled in with 'not applicable'.</p> <p>If you sort the list by that value, the screen is divided into different sections grouped by settlement status.</p>
T2S Reference	Shows the unique identification assigned by T2S to the respective immediate liquidity transfer.
Settlement Date and Time	<p>Shows the date and time when the immediate liquidity transfer was settled.</p> <p>Displayed format is: YYYY-MM-DD hh:mm:ss</p> <p>References for error messages [▶ 1318]:</p> <ul style="list-style-type: none"> <input type="checkbox"/> QMPC015 <input type="checkbox"/> QMPC016 <input type="checkbox"/> QMPC097
Parent BIC	<p>Shows the BIC of the CB that operates the T2S dedicated cash account.</p> <p>References for error messages [▶ 1318]:</p> <ul style="list-style-type: none"> <input type="checkbox"/> QMPC072 <input type="checkbox"/> QMPC084
T2S Dedicated Cash Account Number Debit	<p>Shows the cash account to be debited.</p> <p>If the liquidity transfer is internal or outbound, the cash account is a T2S dedicated cash account.</p>

Immediate Liquidity Transfer Orders – Search Criteria	
	<p>If the liquidity transfer is inbound, the cash account is an External RTGS account, Main Cash Account, RTGS DCA, CLM CB Account, RTGS CB Account or TIPS Account</p> <p>If you sort the list by that value, the screen is divided into different sections grouped by debit cash account numbers.</p>
T2S Dedicated Cash Account Number Credit	<p>Shows the cash account to be credited.</p> <p>If the liquidity transfer is internal or inbound, the cash account is a T2S dedicated cash account.</p> <p>If the liquidity transfer is outbound, the cash account is an External RTGS account, Main Cash Account, RTGS DCA, CLM CB Account, RTGS CB Account or TIPS Account.</p> <p>If you sort the list by that value, the screen is divided into different sections grouped by credit cash account numbers.</p>
Amount	<p>Shows the amount in respect of the settlement status.</p> <p>If the settlement status is set to 'Not executed' or 'Unsettled', the instructed amount is displayed.</p> <p>If the settlement status is set to 'Partially settled' or 'Settled', the transferred amount is displayed.</p>
Interface Sending Date and Time	<p>Shows the time when the outbound liquidity transfer was sent to the RTGS.</p> <p>Displayed format is: hh:mm:ss</p>
Value Date	<p>Shows the value date of the liquidity transfer.</p> <p>Displayed format is: YYYY-MM-DD</p>

Buttons

Search	<p>This function enables you to start a search according to the criteria entered. The results are displayed in a list on the same screen.</p> <p>If the search retrieves a single record, the <i>details</i> screen is displayed directly.</p> <p>Next screens:</p> <ul style="list-style-type: none"> <input type="checkbox"/> <i>Immediate liquidity transfer orders – search/list</i> screen <input type="checkbox"/> <i>Immediate liquidity transfer order – details</i> screen [▶ 382] <p>References for error messages [▶ 1318]:</p>
--------	--

	<ul style="list-style-type: none"> <input type="checkbox"/> QMPC015 <input type="checkbox"/> QMPC031 <input type="checkbox"/> QMPC032 <input type="checkbox"/> QMPC054 <input type="checkbox"/> QMPC072 <input type="checkbox"/> QMPC084
Reset	<p>This function enables you to set default search criteria and blanks out all optional criteria.</p> <p>Next screen:</p> <ul style="list-style-type: none"> <input type="checkbox"/> <i>Immediate liquidity transfer orders – search/list</i> screen
Details	<p>This function enables you to display the details of the selected immediate liquidity transfer.</p> <p>Next screen:</p> <ul style="list-style-type: none"> <input type="checkbox"/> <i>Immediate liquidity transfer order – details</i> screen [▶ 382]
New	<p>This function enables you to create a new immediate liquidity transfer.</p> <p>Next screen:</p> <ul style="list-style-type: none"> <input type="checkbox"/> <i>Immediate liquidity transfer order – new</i> screen [▶ 387]
Related Inbound Messages	<p>This function enables you to display the inbound messages related to the selected immediate liquidity transfer.</p> <p>Next screens:</p> <ul style="list-style-type: none"> <input type="checkbox"/> <i>Inbound messages – search/list</i> screen [▶ 629] (if the immediate liquidity transfer is linked to more than one inbound message) <input type="checkbox"/> <i>Inbound message – details</i> screen [▶ 636] (if the immediate liquidity transfer is linked to one inbound message only)
Related Outbound Messages	<p>This function enables you to display the outbound messages related to the selected immediate liquidity transfer.</p> <p>Next screens:</p> <ul style="list-style-type: none"> <input type="checkbox"/> <i>Outbound messages – search/list</i> screen [▶ 646] (if the immediate liquidity transfer is linked to more than one outbound message)

	<ul style="list-style-type: none"> □ <i>Outbound message - details</i> screen [▶ 654] (if the immediate liquidity transfer is linked to one outbound message only)
Revisions	<p>This function enables you to display the revisions of the selected immediate liquidity transfer order.</p> <p>Next screen:</p> <ul style="list-style-type: none"> □ <i>Revisions/audit trail - list</i> screen
Copy	<p>This function enables you to copy fields to create a new immediate liquidity transfer order with the same attributes.</p> <p>Next screen:</p> <ul style="list-style-type: none"> □ <i>Immediate liquidity transfer order – new</i> screen [▶ 387]

2.3.2.4 Immediate Liquidity Transfer - Details Screen

Context of Usage

This screen displays detailed information on the selected liquidity transfer. You can check the data and proceed further by clicking on the buttons below.

This screen is not relevant for CSD participants and external CSD users.

Screen Access

□ Cash >> Liquidity >> Immediate Liquidity Transfers >> *Immediate liquidity transfer orders – search/lists*screen >> Click on the *search* and/or *details* button

Privileges

To use this screen, you need the following privileges [▶ 1213]:

- Immediate liquidity transfer order detail query
- Immediate liquidity transfer order audit trail list query

References

User Instructions Part

This screen is part of the following business scenario:

- View immediate liquidity transfer order details [▶ 716]

Business Functionality Document

This screen corresponds to the following business function:

- Display immediate liquidity transfer instruction details (T2S.GUI.LMSE.INX.0030)

Screenshot

SECURITIES	CASH	SERVICES	STATIC DATA	MONITORING
Cash > Liquidity > Immediate Liquidity Transfers > Immediate Liquidity Transfer Details				
General Information				
Instructed Settlement Amount 100,000.00	Currency GBP	Debit Cash Account Number ERTGSNDEGBP001	Value Date 2016-10-21	
Transferred Settlement Amount 100,000.00	Settlement Date and Time 2016-10-21 07:31:11.228	Credit Cash Account Number PMBKDED1GBP01	Sending Time ---	
Technical Information				
T2S Reference 164508	Users Reference E161021072922z07	Generated LT No		
Party Information				
Party Parent BIC ---	Party BIC ---	Short Name ---		
Current Status Information				
Settlement Status Settled	Settlement Date and Time 2016-10-21 07:31			
External RTGS Status Not applicable	External RTGS Status Date and Time 2016-10-21 07:31			
Status History Information				
	Date and Time	Status Type	Status Value	User Identification
	2016-10-21 07:31	Settlement Status	Settled	601054
	2016-10-21 07:31	Approval Status	Approved	601054
	2016-10-21 07:31	RTGS Status	Not Applicable	601054
	2016-10-21 07:31	Settlement Status	Not Executed	601054
Rejection Reasons				
<input type="button" value="Copy"/> <input type="button" value="New"/> <input type="button" value="Related Inbound Messages"/> <input type="button" value="Related Outbound Messages"/> <input type="button" value="Revisions"/>				

Illustration 80: Immediate liquidity transfer - details screen

Field

Description

General Information	
Instructed Settlement Amount	Shows the amount originally stated in the settlement instruction.
Transferred Settlement Amount	Shows the total amount settled.
Currency	Shows the currency assigned to the T2S dedicated cash account.
Settlement Date and Time	Shows the date and time of the settlement. Displayed format is: YYYY-MM-DD hh:mm:ss
T2S Dedicated Cash Account Number Debit	Shows the T2S dedicated cash account to be debited.

General Information	
T2S Dedicated Cash Account Number Credit	Shows the T2S dedicated cash account to be credited.
Value Date	Shows the value date of the immediate liquidity transfer. Displayed format is: YYYY-MM-DD
Sending Time	Shows the time when the liquidity transfer was sent to the middleware. Displayed format is: hh:mm:ss If the liquidity transfer is internal, this field is not filled.
Technical Information	
T2S Reference	Shows the identification of the liquidity transfer assigned by T2S.
User Reference	Shows the identification of the liquidity transfer assigned by the T2S actor.
T2S generated	Shows whether a liquidity transfer was generated by T2S from the possible values: <input type="checkbox"/> No (i.e. immediate liquidity transfer) <input type="checkbox"/> Yes (i.e. standing or predefined order) If the value is set to 'Yes', this field also contains the standing or predefined order identification.
Party Information	
Parent BIC	Shows the parent BIC of the party.
Party BIC	Shows the BIC of the party.
Party Short Name	Shows the short name of the party.
Current Status Information	
Settlement Status	Shows the current settlement status of internal, inbound and outbound liquidity transfers from the possible values: <input type="checkbox"/> Settled (for inbound liquidity transfers this is the only possible value) <input type="checkbox"/> Partially settled <input type="checkbox"/> Unsettled <input type="checkbox"/> Not executed
Settlement Date and Time	Shows the date and time of the respective settlement status.

General Information	
	Displayed format is: YYYY-MM-DD hh:mm:ss
External RTGS Status	Shows the current RTGS status of the instruction from the possible values: <ul style="list-style-type: none"> <input type="checkbox"/> RTGS rejection <input type="checkbox"/> RTGS confirmation <input type="checkbox"/> Not executed <input type="checkbox"/> Not applicable <input type="checkbox"/> Rebooking If the liquidity transfer is internal, this field is always filled in with 'Not applicable'.
External RTGS Status Date and Time	Shows the date and time of the respective RTGS status. Displayed format is: YYYY-MM-DD hh:mm:ss
Status History Information	
Date and Time	Shows the date and time when the status was stored. Displayed format is: YYYY-MM-DD hh:mm:ss
Status Type	Shows all status types in a chronological order from the possible values: <ul style="list-style-type: none"> <input type="checkbox"/> Settlement Status <input type="checkbox"/> RTGS Status <input type="checkbox"/> Approval Status Each row represents one status.
Status Value	Shows for each status type all status values in a chronological order. If the status type is set to 'SETT' for internal and outbound liquidity transfers, this field shows the possible values: <ul style="list-style-type: none"> <input type="checkbox"/> Settled <input type="checkbox"/> Partially settled <input type="checkbox"/> Unsettled <input type="checkbox"/> Not executed If the status type is set to 'SETT' for inbound liquidity transfers, this field always shows the status 'Settled'. If the status type is set to 'RTGS' for outbound liquidity transfers, this field shows the possible values:

General Information	
	<ul style="list-style-type: none"> <input type="checkbox"/> RTGS rejection <input type="checkbox"/> RTGS confirmation <input type="checkbox"/> Not executed <p>If the status type is set to 'APPR' for internal and outbound liquidity transfers, this field shows the possible values:</p> <ul style="list-style-type: none"> <input type="checkbox"/> Awaiting approval <input type="checkbox"/> Approved <input type="checkbox"/> Revoked <input type="checkbox"/> Rejected <input type="checkbox"/> Not applicable <p>Each row represents one status.</p>
User Identification	<p>Shows the user identification of those users who changed the status type 'Approval Status', if the liquidity transfer was sent via U2A and in 4-eyes mode.</p> <p>Each row represents one status.</p>
Rejection Reasons	
Date and Time	<p>Shows the date and time of the rejection.</p> <p>Displayed format is: YYYY-MM-DD hh:mm:ss</p> <p>This field is only available if the liquidity transfer was rejected.</p>
Rejection Code	<p>Shows the rejection code in respect of the rejection.</p> <p>This field is only available if the liquidity transfer was rejected.</p>
Rejection Description	<p>Shows the error description according to reference data and business rules.</p> <p>This field is only available if the liquidity transfer was rejected.</p>

Buttons

Copy	<p>This function enables you to copy fields to create a new immediate liquidity transfer order with the same attributes.</p> <p>Next screen:</p> <ul style="list-style-type: none"> <input type="checkbox"/> <i>Immediate liquidity transfer order – new screen</i> [387]
New	<p>This function enables you to create a new immediate liquidity transfer order.</p>

	<p>Next screen:</p> <ul style="list-style-type: none"> □ <i>Immediate liquidity transfer order – new screen</i> [387]
Related Inbound Messages	<p>This function enables you to display the inbound messages related to the selected inbound file.</p> <p>Next screens:</p> <ul style="list-style-type: none"> □ <i>Inbound messages - search/list screen</i> [▶ 629] (if the inbound file is linked to more than one inbound message) □ <i>Inbound message – details screen</i> [▶ 636] (if the inbound file is linked to one inbound message only)
Related Outbound Messages	<p>This function enables you to display the outbound messages related to the selected outbound file.</p> <p>Next screens:</p> <ul style="list-style-type: none"> □ <i>Outbound messages – search/list screen</i> [646] (if the outbound file is linked to more than one outbound message) □ <i>Outbound message – details screen</i> [654] (if the outbound file is linked to one outbound message only)
Revisions	<p>This function enables you to display the revisions of the selected immediate liquidity transfer order.</p> <p>Next screen:</p> <ul style="list-style-type: none"> □ <i>Revisions/audit trail - list screen</i> [▶ 662]

2.3.2.5 Immediate Liquidity Transfer - New Screen

Context of Usage

This screen contains a number of fields regarding immediate liquidity transfers. You can enter data to create a new internal or outbound liquidity transfer. Afterwards you can proceed further by clicking on the buttons below.

You can use this screen either in 2-eyes or in 4-eyes mode.

This screen is not relevant for CSD, CSD participants and external CSD users.

Screen Access

- Cash >> Liquidity >> Immediate Liquidity Transfers >> *Immediate liquidity transfer orders – search/list screen* >> Click on the *new* or *copy* button
- Cash >> Liquidity >> Immediate Liquidity Transfers >> *Immediate liquidity transfer orders – search/list screen* >> Click on the *search* and/or *details* button >> *Immediate liquidity transfer order – details screen* >> Click on the *new* or *copy* button

- Services >> Additional Services >> Data Changes >> *Data changes – search/list* screen >> Click on the *copy* button
- Securities >> Settlement >> Data Changes >> *Data changes – search/list* screen >> Click on the *copy* button
- Cash >> Liquidity >> Data Changes >> *Data changes – search/list* screen >> Click on the *copy* button
- Services >> Additional Services >> Data Changes >> *Data changes – search/list* screen >> Click on the *search* and/or *details* button >> *Data change – details* screen >> Click on the *copy* button
- Securities >> Settlement >> Data Changes >> *Data changes – search/list* screen >> Click on the *search* and/or *details* button >> *Data change – details* screen >> Click on the *copy* button
- Cash >> Liquidity >> Data Changes >> *Data changes – search/list* screen >> Click on the *search* and/or *details* button >> *Data change – details* screen >> Click on the *copy* button

Privileges To use this screen, you need the following privilege [▶ 1213]:

- Send new liquidity transfer

References **User Instructions Part**

This screen is part of the following business scenarios:

- Create a new immediate liquidity transfer order
- Copy an immediate liquidity transfer order [▶ 712]

Business Functionality Document

This screen corresponds to the following business function:

- Add immediate liquidity transfer instruction (T2S.GUI.LMSE.INX.0040)

Screenshot

Illustration 81: Immediate liquidity transfer order - new screen

Field

Description

Immediate Liquidity Transfer	
Debit Cash Account	
T2S Dedicated Cash Account Number*	Select the T2S dedicated cash account to be debited. References for error messages [▶ 1314]: <input type="checkbox"/> LLCI002 <input type="checkbox"/> LLCI006 <input type="checkbox"/> LLCI007 <input type="checkbox"/> LLCI008 <input type="checkbox"/> LLCI015 <input type="checkbox"/> LLCP001 If you only have the privilege for one T2S dedicated cash account, this field is already filled in.
T2S Dedicated Cash Account Owner Debit	Shows the BIC of the account owner. If you have first selected the 'T2S Dedicated Cash Account Number', this field is already filled in.
Liquidity Transfer	
User Reference*	Enter the identification of the immediate liquidity transfer. Required format is: max. 35 characters (SWIFT-x-red) References for error messages [▶ 1314]: <input type="checkbox"/> LLCI007

Immediate Liquidity Transfer	
	<input type="checkbox"/> LLCI016 <input type="checkbox"/> LLCI017 <p>This field is automatically filled with the current date and time and the first two digits of the user identification.</p> <p>You can edit the prefilled identification and insert your specific identification.</p> <p>For any non EURO Liquidity Transfer the required format is max. 16 characters (SWIFT-x-red)</p>
Creditor BIC	This field can be filled for outbound Liquidity Transfers towards TIPS. The required format is BIC-11. No additional Business Validations on this field.
Debtor BIC	This field must be filled for outbound Liquidity Transfers towards TIPS. The required format is BIC-11. No additional Business Validations on this field.
Amount*	<p>Enter the amount of liquidity to be transferred.</p> <p>Required format is: max. 15 digits incl. decimal point</p> <p>References for error messages [1314]:</p> <input type="checkbox"/> LLCI005 <input type="checkbox"/> LLCI006 <input type="checkbox"/> LLCI007 <input type="checkbox"/> LLCI012 <input type="checkbox"/> LLCI014 <input type="checkbox"/> LLCI015 <p>The currency is automatically filled in, according to the 'T2S Dedicated Cash Account Number', next to the 'Amount' field.</p>
Credit Cash Account	
Outbound Liquidity Transfer	<p>Select if you want to enter an outbound liquidity transfer.</p> <p>You have to select one field among 'Outbound Liquidity Transfer' and 'Internal Liquidity Transfer'.</p>
Internal Liquidity Transfer	<p>Select if you want to enter an internal liquidity transfer.</p> <p>You have to select one field among 'Internal Liquidity Transfer' and 'Outbound Liquidity Transfer'.</p>

Immediate Liquidity Transfer	
External Account Number*	<p>You can choose to either enter the external RTGS account, Main Cash Account, RTGS DCA or TIPS DCA (including CB accounts) ¹⁶ to be credited for the outbound liquidity transfer or to select it from the suggested items in the drop-down menu.</p> <p>Required format is: max. 35 characters (SWIFT-x)</p> <p>The default value is the RTGS account which is linked to the T2S dedicated cash account for the end-of-day liquidity transfer(for a currency not open in CLM) or the linked MCA ¹⁶.</p> <p>If you have selected 'Outbound Liquidity Transfer', this field is mandatory.</p> <p>If you have selected 'Internal Liquidity Transfer', this field is not available.</p> <p>References for error messages [▶ 1314]:</p> <ul style="list-style-type: none"> <input type="checkbox"/> LLCI003 <input type="checkbox"/> LLCI006 <input type="checkbox"/> LLCI007 <input type="checkbox"/> LLCI008 <input type="checkbox"/> LLCI015
T2S Dedicated Cash Account Number*	<p>You can choose to either enter the T2S dedicated cash account to be credited for the outbound liquidity transfer or to select it from the suggested items in the drop-down menu.</p> <p>If you have selected 'Internal Liquidity Transfer', this field is mandatory.</p> <p>If you have selected 'Outbound Liquidity Transfer', this field is not available.</p> <p>References for error messages [▶ 1314]:</p> <ul style="list-style-type: none"> <input type="checkbox"/> LLCI003 <input type="checkbox"/> LLCI006 <input type="checkbox"/> LLCI007 <input type="checkbox"/> LLCI008

16 Please note that the described functionality won't be available before CSLD go-live.

Immediate Liquidity Transfer	
<input type="checkbox"/>	LLCI010
<input type="checkbox"/>	LLCI015

Buttons

Submit	<p>This function enables you to create a new immediate liquidity transfer. Upon clicking on the <i>submit</i> button you will be asked to enter your PIN for digital signature purposes (NRO). With the entry of the PIN, T2S attaches a digital signature to the instruction entered by the T2S actor.</p> <p>Next screen:</p> <ul style="list-style-type: none"> <input type="checkbox"/> <i>Immediate liquidity transfer order – new screen</i> <p>References for error messages [▶ 1314]:</p> <ul style="list-style-type: none"> <input type="checkbox"/> LLCI002 <input type="checkbox"/> LLCI003 <input type="checkbox"/> LLCI005 <input type="checkbox"/> LLCI006 <input type="checkbox"/> LLCI007 <input type="checkbox"/> LLCI008 <input type="checkbox"/> LLCI009 <input type="checkbox"/> LLCI010 <input type="checkbox"/> LLCI012 <input type="checkbox"/> LLCI014 <input type="checkbox"/> LLCI015 <input type="checkbox"/> LLCI016
Reset	<p>This function enables you to set all fields to default value and blanks out all optional fields.</p> <p>Next screen:</p> <ul style="list-style-type: none"> <input type="checkbox"/> <i>Immediate liquidity transfer order – new screen</i> [▶ 1213]
Cancel	<p>This function enables you to cancel the process and return to the previous screen.</p> <p>Next screen:</p> <ul style="list-style-type: none"> <input type="checkbox"/> <i>Immediate liquidity transfer orders – search/list screen</i> [▶ 374]

2.3.2.6 Outstanding Auto-Collateralisation Credits - Search/List Screen

Context of Usage

This screen contains a number of search fields. By inputting the relevant data, you can search for the global and detailed outstanding auto-collateralisation credits for parties which are credit consumers, either as a payment bank obtaining credit from a central bank or as a client of a payment bank obtaining credit from its payment bank. The search results for the global outstanding auto-collateralisation credits for the selected party will be displayed on the same screen. Below this, the detailed search results for the outstanding auto-collateralisation credits per T2S dedicated cash account will be displayed in a list, which is sorted by the values of the 'T2S Dedicated Cash Account Number' column in ascending order (default setting). After selecting an entry, you can proceed further by clicking on the buttons below.

The amount of outstanding auto-collateralisation refers to the limit utilisation of an auto-collateralisation limit. Payment bank users can see the outstanding auto-collateralisation credit obtained from their central bank on their T2S dedicated cash account, while clients of a payment bank can see the outstanding auto-collateralisation credit obtained from their payment bank related to the T2S dedicated cash account of their payment bank.

During the Start of Day, when the CRDM data is being replicated in the Settlement domain, only the outstanding auto-collateralisation credits data available at the End-of-Day of the previous business day is displayed at the screen. The outstanding auto-collateralisation credits data for the new business day is available as of the end of the CRDM data replication.{CR-634}

During night-time, the outstanding auto-collateralisation credits can only be displayed in-between night-time settlement sequences.

Screen Access

Cash >> Liquidity >> Outstanding Auto-Coll. Credit

Privileges

To use this screen, you need the following privilege [**▶** 1222]:

Outstanding auto-collateralisation credit query

References

User Instructions Part

This screen is not part of a business scenario.

Business Functionality Document

This screen corresponds to the following business functions:

- Query outstanding auto/client collateralisation credit (T2S.GUI.LMSE.CSH.0150)
- Display outstanding auto/client collateralisation credit (T2S.GUI.LMSE.CSH.0160)

Screenshot

Cash > Liquidity > Outstanding Auto-Collateralisation

Search Criteria - Outstanding Auto-Coll. Credit

Parent BIC * [NCBKDEFF001] Party BIC * [PMBKDEFF001]

T2S Dedicated Cash Account Number Currency [EUR]

Search Reset

Outstanding Auto-Collateralisation Credit - Global

Credit Consumer

Party BIC [PMBKDEFF001] Parent BIC [NCBKDEFF001] Party Short Name [PMBKDEFF001 Short Name]

Currency [EUR] Total Limit [1,361,025.00] Total Outstanding Limit [0.00]

Rows per page: 10 page 1 of 1 - lines 1 to 7 of 7 Go to page: 1

T2S Dedicated Cash Account Number	Cur.	Limits	
		Limit Amount	Outstanding Limit
CSHANODEEU0001	EUR	250,025.00	0.00
CSHANODEEU0002	EUR	0.00	0.00
CSHANODEEU0010	EUR	100,000.00	0.00
CSHANODEEU0013	EUR	1,000,000.00	0.00
CSHANODEEU0017	EUR	10,000.00	0.00
CSHANODEEU0050	EUR	0.00	0.00
CSHANODEEURAB61a	EUR	1,000.00	0.00

Rows per page: 10 page 1 of 1 - lines 1 to 7 of 7 Go to page: 1

Journal of Limit Utilisation

Illustration 82: Outstanding auto-collateralisation credits – search/list screen

Field Descriptions

Outstanding Auto-collateralisation Credit – Search Criteria	
Credit Consumer	
Party BIC*	Select the party BIC of the credit consumer from the drop-down menu or search via the <i>magnifier</i> icon. Reference for error message [▶ 1374]: <input type="checkbox"/> QMPC084
Parent BIC*	Select the parent BIC of the credit consumer from the drop-down menu or search via the <i>magnifier</i> icon. If the credit consumer is a payment bank, this is the BIC of its CB. If the credit consumer is a client of a payment bank, this is the BIC of its CSD. Reference for error message [▶ 1374]: <input type="checkbox"/> QMPC084
T2S Dedicated Cash Account Number	Select the number of the T2S dedicated cash account from the drop-down menu.

Outstanding Auto-collateralisation Credit – Search Criteria	
	<p>The content of the drop-down menu depends on your access rights and privileges:</p> <ul style="list-style-type: none"> <input type="checkbox"/> If there is only one possible account, this field is read-only. <input type="checkbox"/> If the credit consumer is a payment bank, possible values are its T2S dedicated cash account(s). <input type="checkbox"/> If the credit consumer is the client of a payment bank, possible values are the T2S dedicated cash account(s) of its payment bank with which the client obtains auto-collateralisation credit. <p>Required format is: max. 34 characters (SWIFT-x)</p> <p>If you leave this field blank, the privileges and access rights of the requesting party are applied.</p> <p>At least one search criterion among 'T2S Dedicated Cash Account Number' and 'Currency' must be specified.</p> <p>Reference for error message [▶ 1374]:</p> <ul style="list-style-type: none"> <input type="checkbox"/> QMPC031
Currency	<p>Select the currency of the outstanding auto-collateralisation credit from the drop-down menu. The default value is 'all'.</p> <p>At least one search criterion among 'T2S Dedicated Cash Account Number' and 'Currency' must be specified. If a T2S dedicated cash account is selected, the query disregards the currency.</p>
Outstanding Auto-collateralisation Credit - Global	
Credit Consumer	
Party BIC	<p>Shows the BIC of the credit consumer party.</p> <p>Reference for error message [▶ 1374]:</p> <ul style="list-style-type: none"> <input type="checkbox"/> QMPC084
Parent BIC	<p>Shows the parent BIC of the credit consumer party.</p> <p>Reference for error message [▶ 1374]:</p> <ul style="list-style-type: none"> <input type="checkbox"/> QMPC084
Party Short Name	Shows the short name of the credit consumer party.
Limits	
Currency	Shows the currency of the auto-collateralisation credit.

Outstanding Auto-collateralisation Credit – Search Criteria	
Total Limit	Shows the sum of the auto-collateralisation limits associated to the selected party and the selected T2S dedicated cash account. Provision of '99999...99' in case oversizing occurs in the integer part. Truncation of decimals in case oversizing occurs in the decimal part.
Total Outstanding Limit	Shows the sum of the auto-collateralisation limit utilisations associated to the selected party and the selected T2S dedicated cash account. Provision of '99999...99' in case oversizing occurs in the integer part. Truncation of decimals in case oversizing occurs in the decimal part.
Outstanding Auto-collateralisation Credit - List	
T2S Dedicated Cash Account Number	Shows the T2S dedicated cash account that the party can use. Reference for error message [▶ 1374]: <input type="checkbox"/> QMPC031
Currency	Shows the currency of the T2S dedicated cash account.
Limits	
Limit Amount	Shows the auto-collateralisation limit associated to the T2S dedicated cash account.
Outstanding Limit	Shows the utilisation of the auto-collateralisation limit associated to the T2S dedicated cash account.

Buttons

Buttons	
Search	This function enables you to start a search according to the criteria entered. The results are displayed in a list on the same screen. Next screen: <input type="checkbox"/> <i>Outstanding auto-collateralisation credits – search/list screen</i> References for error message [▶ 1374]s [▶ 1374]: <input type="checkbox"/> QMPC031 <input type="checkbox"/> QMPC084
Reset	This function enables you to set default search criteria and blanks out all optional criteria.

	Next screen: <input type="checkbox"/> <i>Outstanding auto-collateralisation credits – search/list screen</i>
Journal of Limit Utilisation	This function enables you to display the journal of limit utilisation. Next screen: <input type="checkbox"/> <i>Limit utilisation journal – search/list screen</i> [▶ 353]

2.3.2.7 Overall Liquidity - Search/List Screen

Context of Usage

This screen contains a number of search fields. By inputting the relevant data, you can search for the overall liquidity available for a party. The search results will be displayed in an overview list.

After selecting an entry, you can proceed further by clicking on the buttons below.

This screen is not relevant for CSD, CSD participants and external CSD user.

During the Start of Day, when the CRDM data is being replicated in the Settlement domain, only the liquidity available at the End-of-Day of the previous business day is displayed at the screen. The liquidity data for the new business day is available as of the end of the CRDM data replication.

{CR-634}

During night-time, the overall liquidity overview and detailed lists can only be displayed in-between night-time settlement sequences.

Screen Access

Cash >> Liquidity >> T2S Overall Liquidity

Privileges

To use this screen, you need the following privilege [▶ 1222]:

T2S overall liquidity query

References

User Instructions Part

This screen is part of the following business scenario:

View overall liquidity [▶ 718]

Business Functionality Document

This screen corresponds to the following business functions:

Query overall liquidity (T2S.GUI.LMSE.CSH.0070)

Display overall liquidity (T2S.GUI.LMSE.CSH.0080)

Screenshot

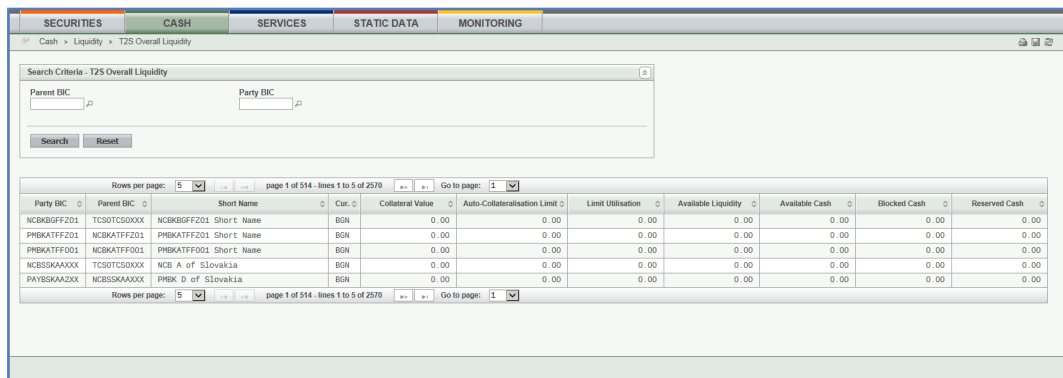

Illustration 83: Overall liquidity – search/list screen

Field Descriptions

Overall Liquidity – Search Criteria	
Parent BIC	Select the parent BIC of the party from the drop-down menu or search via the <i>magnifier</i> icon. References for error messages [▶ 1375]: <input type="checkbox"/> QMPC048 <input type="checkbox"/> QMPC084 If there is only one possible party parent BIC for your privileges, this field is already filled in.
Party BIC	Select the BIC of the party from the drop-down menu or search via the <i>magnifier</i> icon. References for error messages [▶ 1375]: <input type="checkbox"/> QMPC032 <input type="checkbox"/> QMPC084 If there is only one possible party BIC for your privileges, this field is already filled in.
Overall Liquidity – Overview List	
Party BIC	Shows the party BIC of the party owning the account. References for error messages [▶ 1375]: <input type="checkbox"/> QMPC032 <input type="checkbox"/> QMPC084
Parent BIC	Shows the parent BIC of the party owning the account. References for error messages [▶ 1375]: <input type="checkbox"/> QMPC048 <input type="checkbox"/> QMPC084
Party Short Name	Shows the short name of the party owning the account.
Currency	Shows the currency of the T2S dedicated cash account.

Overall Liquidity – Search Criteria	
Auto-Collateralisation Limit	Shows the auto-collateralisation limit set by the CB. Provision of '99999...99' in case oversizing occurs in the integer part. Truncation of decimals in case oversizing occurs in the decimal part.
Limit Utilisation	Shows the utilisation of the auto-collateralisation limit. Provision of '99999...99' in case oversizing occurs in the integer part. Truncation of decimals in case oversizing occurs in the decimal part.
Available Liquidity	Shows the sum of the available liquidity. The figure consists of the sum of the available cash balance, the sum of blocked cash, the sum of reserved cash plus the minimum value between: <ul style="list-style-type: none"> <input type="checkbox"/> The difference between the auto-collateralisation limit and the limit utilisation or <input type="checkbox"/> The collateral value Provision of '99999...99' in case oversizing occurs in the integer part. Truncation of decimals in case oversizing occurs in the decimal part.
Overall Liquidity – Detailed List	
Party BIC	Shows the party BIC of the party owning the account. References for error messages [▶ 1375]: <ul style="list-style-type: none"> <input type="checkbox"/> QMPC032 <input type="checkbox"/> QMPC084
Parent BIC	Shows the parent BIC of the party owning the account. References for error messages [▶ 1375]: <ul style="list-style-type: none"> <input type="checkbox"/> QMPC048 <input type="checkbox"/> QMPC084
Party Short Name	Shows the short name of the party owning the account.
Currency	Shows the currency of the T2S dedicated cash account.
Collateral Value	Shows the collateral value of the securities on stock in T2S, which are eligible for auto-collateralisation purposes. Provision of '99999...99' in case oversizing occurs in the integer part. Truncation of decimals in case oversizing occurs in the decimal part.
Available Cash	Shows the sum of available cash.

Overall Liquidity – Search Criteria	
	Provision of '99999...99' in case oversizing occurs in the integer part. Truncation of decimals in case oversizing occurs in the decimal part.
Blocked Cash	Shows the sum of blocked cash. Provision of '99999...99' in case oversizing occurs in the integer part. Truncation of decimals in case oversizing occurs in the decimal part.
Reserved Cash	Shows the sum of reserved cash. Provision of '99999...99' in case oversizing occurs in the integer part. Truncation of decimals in case oversizing occurs in the decimal part.

Buttons

Buttons	
Search	This function enables you to start a search according to the criteria entered. The results are displayed in an overview list on the same screen. Next screen: <input type="checkbox"/> Overall liquidity – search/list screen References for error messages [▶ 1375]: <input type="checkbox"/> QMPC032 <input type="checkbox"/> QMPC048 <input type="checkbox"/> QMPC084
Reset	This function enables you to set default search criteria and blanks out all optional criteria. Next screen: <input type="checkbox"/> Overall liquidity – search/list screen
Detailed list	This function enables you to display the overall liquidity detailed list. Next screen: <input type="checkbox"/> Overall liquidity – search/list screen This function is only available if the overview list is displayed.
Overview list	This function enables you to display the overall liquidity overview list. Next screen:

<input type="checkbox"/>	<i>Overall liquidity – search/list screen</i> This function is only available if the detailed list is displayed.

2.3.2.8 Standing/Predefined Liquidity Transfer Orders - Search/List Screen

See *Standing/Predefined Liquidity Transfer Orders – Search/List Screen*.

2.3.2.9 Standing/Predefined Liquidity Transfer Order - Details Screen

See *Standing/Predefined Liquidity Transfer Order – Details Screen*.

2.3.2.10 Standing/Predefined Liquidity Transfer Order - New/Edit Screen

See *Standing/Predefined Liquidity Transfer Order – New/Edit Screen*.

2.3.2.11 Standing/Predefined Liquidity Transfer Order Link Sets - Search/List Screen

See *Standing/Predefined Liquidity Transfer Order Link Sets – Search/List Screen*.

2.3.2.12 Standing/Predefined Liquidity Transfer Order Link Set - Details Screen

See *Standing/Predefined Liquidity Transfer Order Link Set – Details Screen*.

2.3.2.13 Standing/Predefined Liquidity Transfer Order Link Set - New/Edit Screen

See *Standing/Predefined Liquidity Transfer Order Link Set – New/Edit Screen*.

2.3.2.14 Total Amount of Standing/Predefined Liquidity Transfer Orders - Search/List Screen

Context of Usage

This screen contains a number of search fields. By inputting the relevant data, you can search for information on the execution of standing and predefined liquidity transfer orders scheduled to be executed during the current business day. The search results will be displayed in a list, which is sorted by the values of the

'Parent BIC' column and subsequently by 'Party BIC' in ascending order (default setting). After selecting an entry, detailed information on the standing and predefined liquidity transfer orders initiated by this party will be displayed.

This screen is not relevant for CSD, external CSD and CSD participant users.

Screen Access

- Cash >> Liquidity >> Total Stand./Predef. Liq. Transfers
- Cash >> Liquidity >> Standing/Predefined Liq. Transfers>> *Standing/predefined liquidity transfer orders – search/list screen* >> Click on the *total amount of standing/predefined liquidity transfer orders* button
- Cash >> Liquidity >> Standing/Predefined Liq. Transfers>> *Standing/predefined liquidity transfer orders – search/list screen* >> Click on the *search* and/or *details* button >> *Standing/predefined liquidity transfer order - details screen* >> Click on the *total amount of standing/predefined liquidity transfer orders* button

Privileges

To use this screen, you need the following privilege [[▶ 1234](#)]:

- Total amount of standing and predefined orders query

References

User Instructions Part

This screen is part of the following business scenario:

- View standing/predefined liquidity transfer order details

Business Functionality Document

This screen corresponds to the following business functions:

- Query total amount of predefined and standing liquidity transfer order (T2S.GUI.SDSE.LTO.0070)
- Display total amount of predefined and standing liquidity transfer orders (T2S.GUI.SDSE.LTO.0080)

Total Amount of Standing/Predefined Liquidity Transfer Orders - Search/List Screen

Screenshot

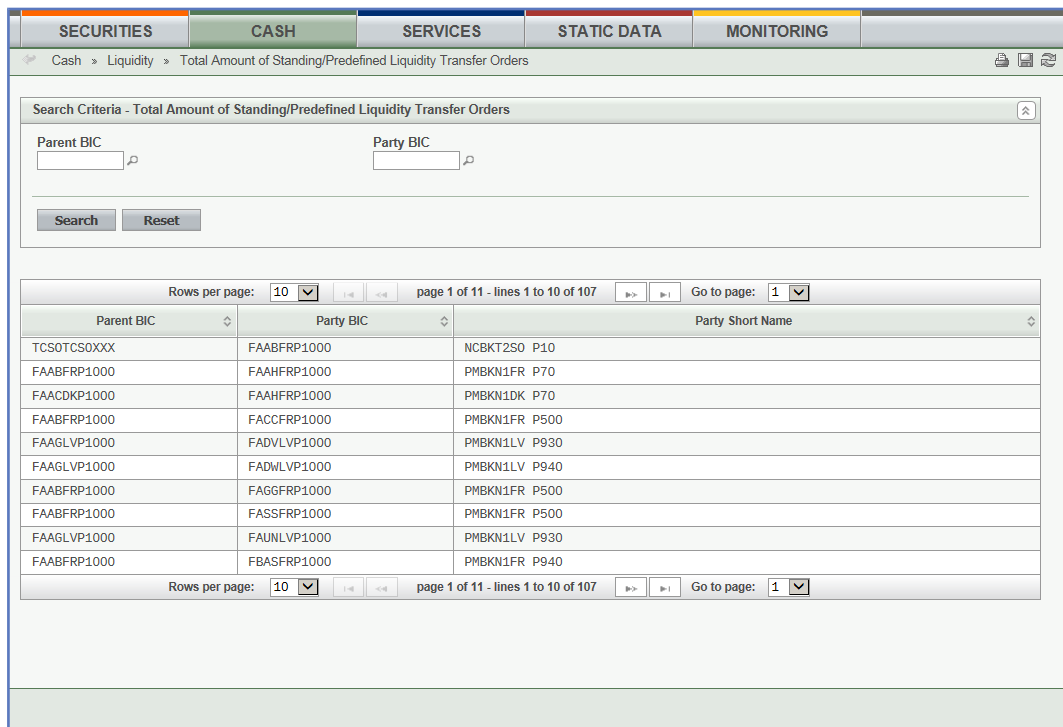

Illustration 84: Total amount of standing/predefined liquidity transfer orders - search/list screen

Field Description

Total Amount of Standing/Predefined Liquidity Transfer Orders - Search Criteria	
Parent BIC	<p>Select the parent BIC of the party that initiated the standing or predefined liquidity transfer order from the drop-down menu or search via the magnifier icon.</p> <p>Required format is: max. 11 characters (SWIFT-x)</p> <p>References for error messages [1451]:</p> <ul style="list-style-type: none"> <input type="checkbox"/> QMPC048 <input type="checkbox"/> QMPC084 <p>If there is only one possible parent BIC for your privileges, this field is already filled in and read-only.</p>
Party BIC	<p>Select the BIC of the party that initiated the standing or predefined liquidity transfer order from the drop-down menu or search via the magnifier icon.</p> <p>Required format is: max. 11 characters (SWIFT-x)</p> <p>References for error messages [1451]:</p> <ul style="list-style-type: none"> <input type="checkbox"/> QMPC032 <input type="checkbox"/> QMPC084 <p>If there is only one possible party BIC for your privileges, this field is already filled in and read-only.</p>

Total Amount of Standing/Predefined Liquidity Transfer Orders - Search Criteria	
Total Amount of Standing/Predefined Liquidity Transfer Orders - List	
Parent BIC	Shows the parent BIC of the party that initiated the standing or predefined liquidity transfer order. References for error messages [▶ 1451]: <input type="checkbox"/> QMPC048 <input type="checkbox"/> QMPC084
Party BIC	Shows the BIC of the party that initiated the standing or predefined liquidity transfer order. References for error messages [▶ 1451]: <input type="checkbox"/> QMPC032 <input type="checkbox"/> QMPC084
Party Short Name	Shows the short name of the party that initiated the standing or predefined liquidity transfer order.
Standing and Predefined Liquidity Transfer Orders - List	
Currency	Shows the currency of the standing or predefined liquidity transfer order.
Predefined Orders	
Sum of Predefined Liquidity Transfer Orders	Shows the sum of the predefined liquidity transfer orders for the current business day.
Sum of Not Yet Executed Liquidity Transfer Orders	Shows the sum of not yet executed predefined liquidity transfer orders for the current business day.
Standing Orders	
Sum of Standing Liquidity Transfer Orders	Shows the sum of the defined standing liquidity transfer orders for the current business day.
Sum of Not Yet Executed Liquidity Transfer Orders	Shows the sum of not yet executed standing liquidity transfer orders for the current business day.
Buttons	
Search	This function enables you to start a search according to the criteria entered. The results are displayed in a list on the same screen.

	<p>If the search retrieves only one party BIC, the detailed list of standing and predefined liquidity transfers for the party is displayed directly.</p> <p>Next screen:</p> <ul style="list-style-type: none"> <input type="checkbox"/> <i>Total amount of standing/predefined liquidity transfer orders – search/list screen</i> <p>References for error messages [▶ 1451]:</p> <ul style="list-style-type: none"> <input type="checkbox"/> QMPC032 <input type="checkbox"/> QMPC048 <input type="checkbox"/> QMPC084
Reset	<p>This function enables you to set default search criteria and blanks out all optional criteria.</p> <p>Next screen:</p> <ul style="list-style-type: none"> <input type="checkbox"/> <i>Total amount of standing/predefined liquidity transfer orders – search/list screen</i>

2.3.3 Settlement

2.3.3.1 Amendment Cash Instruction - Details Screen

Context of Usage

This screen displays detailed information on the selected amendment cash instruction. You can check the data and proceed further by clicking on the buttons below.

This screen is not relevant for CSD users.

Screen Access

Cash >> Settlement >> Maintenance Cash Instructions >> *Maintenance cash instructions – search/list screen* >> Click on the *search* and/or *details* button

Privileges

To use this screen, you need the following privilege [▶ 1196]:

Amendment instruction for intra-balance movement audit trail list query

References

User Instructions Part

This screen is part of the following business scenario:

View amendment instruction for a settlement restriction on cash details [▶ 813]

Business Functionality Document

This screen corresponds to the following business function:

Display instruction details (T2S.GUI.SESE.INX.0030)

Screenshot

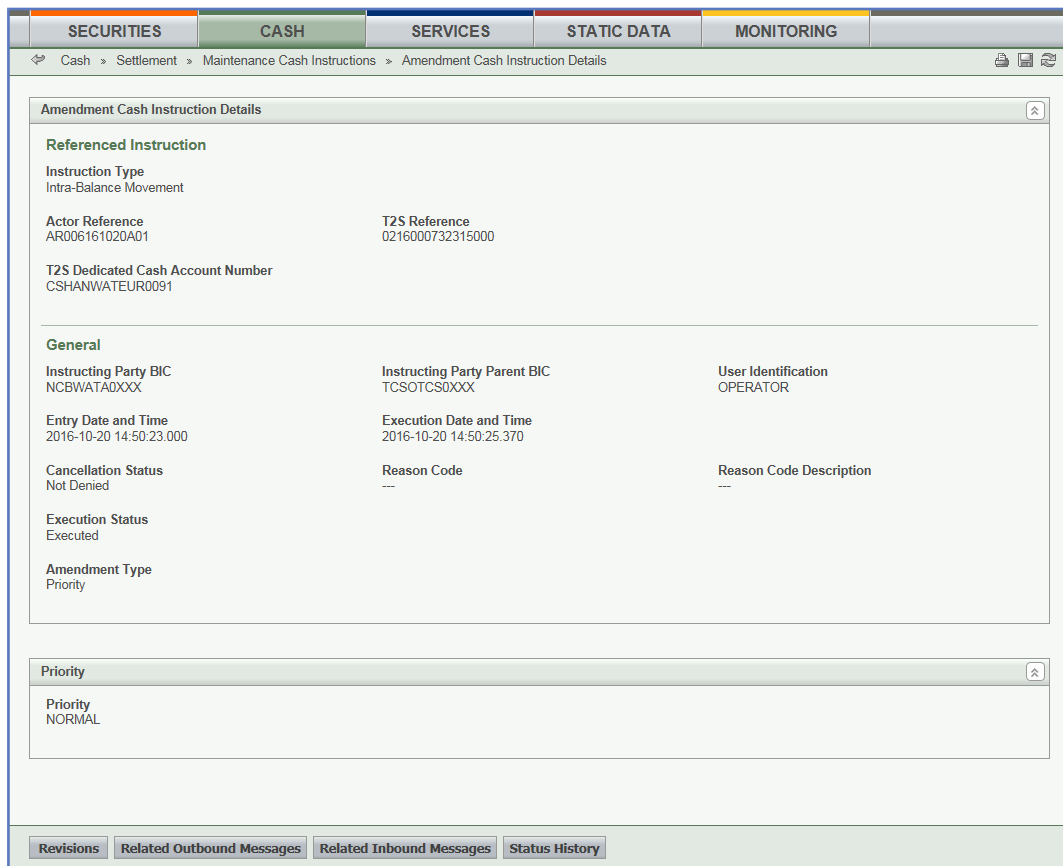

Illustration 85: Amendment cash instructions - details screen

Field Description

Amendment Instruction	
Referenced Instruction	
Instruction Type	Shows the type of instruction referenced by the amendment cash instruction. The only possible value is 'Intra-Balance Movement'.
Actor Reference	Shows the identification assigned by the T2S actor to the settlement restriction on cash.
T2S Reference	Shows the identification given for a settlement restriction on cash by T2S.
T2S Dedicated Cash Account Number	Shows the number of the cash account used by the settlement restriction on cash.
General	
Instructing Party BIC	Shows the BIC of the instructing party.
Instructing Party Parent BIC	Shows the parent BIC of the instructing party.
User Identification	Shows user identification of the sending party.

Amendment Instruction	
Entry Date and Time	Shows the date and time when the amendment instruction has entered in T2S. Displayed format is: YYYY-MM-DD hh:mm:ss:µsµsµsµsµs
Execution Date and Time	Shows the date and time when the amendment instruction has been executed. Displayed format is: YYYY-MM-DD hh:mm:ss:µsµsµsµsµs
Cancellation Status	Shows the cancellation status of the amendment instruction from the possible values: <input type="checkbox"/> DEND (for 'Denied') <input type="checkbox"/> NDEN: (for 'Not denied') If the field 'Reason Code' is informed, the cancellation status is set to 'DEND'.
Reason Code	Shows the reason code that informs the reasoning why the amendment instruction has been denied.
Reason Code Description	Shows the description of the reasoning why the amendment instruction has been denied.
Execution Status	Shows the execution status of the amendment instruction from the possible values: <input type="checkbox"/> EXCD (for 'Executed') <input type="checkbox"/> NEXD: (for 'Not executed')
Amendment Type	Shows the amendment instruction type from the possible values: <input type="checkbox"/> Priority <input type="checkbox"/> Linkages If the value is set to 'Priority', the 'Priority' frame is displayed. If the value is set to 'Linkages', the 'Links' frame is displayed.
Priority	
Priority	Shows the value of the priority assigned by the amendment instruction from the possible values: <input type="checkbox"/> Normal <input type="checkbox"/> High <input type="checkbox"/> Reserved

Amendment Instruction	
	This frame is only available if the amendment type is set to 'Priority'.
Links	
Link	Shows the type of the link action indicated in the amendment instruction from the possible values: <ul style="list-style-type: none"> <input type="checkbox"/> Link <input type="checkbox"/> Unlink This frame is only available if the amendment type is set to 'Linkages'.
Link Type	Shows the processing position indicated in the amendment instruction from the possible values: <ul style="list-style-type: none"> <input type="checkbox"/> After <input type="checkbox"/> Before <input type="checkbox"/> With This frame is only available if the amendment type is set to 'Linkages'.
Reference Type	Shows the reference type of the instruction to be linked/unlinked to from the possible values: <ul style="list-style-type: none"> <input type="checkbox"/> Account owner settlement instruction reference <input type="checkbox"/> Account owner intra balance movement reference <input type="checkbox"/> Account owner intra position movement reference <input type="checkbox"/> Account servicer reference <input type="checkbox"/> Third party reference <input type="checkbox"/> T2S reference This frame is only available if the amendment type is set to 'Linkages'.
Reference	Shows the identification of the instruction to be linked/unlinked to. <p>This frame is only available if the amendment type is set to 'Linkages'.</p>
Reference Owner	Shows the BIC of the instructing party of the instruction to be linked/unlinked to. <p>This field is only filled in if the 'Reference Type' field is set to any value different than 'T2S Reference'.</p>

Amendment Instruction	
	This frame is only available if the amendment type is set to 'Linkages'.

Buttons

Buttons	
Revisions	<p>This function enables you to display the revisions of the selected amendment instruction.</p> <p>Next screen:</p> <ul style="list-style-type: none"> <input type="checkbox"/> <i>Revisions/audit trail – list</i> screen [▶ 662]
Related Outbound Message	<p>This function enables you to display the outbound messages related to the selected amendment instruction.</p> <p>In case the amendment instruction is linked to more than one outbound message, the <i>outbound messages - search/list</i> screen is displayed.</p> <p>In case the query returns only one valid message, the <i>outbound message – details</i> screen is displayed directly.</p> <p>Next screens:</p> <ul style="list-style-type: none"> <input type="checkbox"/> <i>Outbound messages – search/list</i> screen [▶ 646] <input type="checkbox"/> <i>Outbound message – details</i> screen [▶ 654]
Related Inbound Message	<p>This function enables you to display the inbound messages related to the selected amendment instruction.</p> <p>In case the amendment instruction is linked to more than one inbound message, the <i>inbound messages - search/list</i> screen is displayed.</p> <p>In case the query returns only one valid message, the <i>inbound message – details</i> screen is displayed directly.</p> <p>Next screens:</p> <ul style="list-style-type: none"> <input type="checkbox"/> <i>Inbound messages – search/list</i> screen [▶ 629] <input type="checkbox"/> <i>Inbound message – details</i> screen [▶ 636]
Status History	<p>This function enables you to display the status history of the selected amendment instruction.</p> <p>Next screen:</p> <ul style="list-style-type: none"> <input type="checkbox"/> <i>Status history – details</i> screen [▶ 267]

2.3.3.2 Amendment Cash Instruction - New Screen

Context of Usage	<p>This screen contains a number of fields regarding the amendment of settlement restriction on cash before its actual settlement or cancellation. You can enter new data. Afterwards you can proceed further by clicking on the buttons below.</p> <p>You can use this screen either in 2-eyes or in 4-eyes mode.</p> <p>This screen is not relevant for CSD users.</p>
Screen Access	<ul style="list-style-type: none">□ Cash >> Settlement >> Intra-Balance Movements >> <i>Intra-balance movements – search/list</i> screen >> Click on the <i>search</i> button >> <i>Intra-balance movements – search/list</i> screen >> Click on the <i>details</i> button >> <i>Intra-balance movement - details</i> screen >> Click on the <i>amendment instruction</i> button
Privileges	<p>To use this screen you need the following privileges [▶ 1197]:</p> <ul style="list-style-type: none">□ Amend process indicator settlement restriction on cash on a dedicated cash account□ Link to an instruction/pool reference belonging to a specific party□ Send new instruction using a specific instructing party
References	<p>User Instructions Part</p> <p>This screen is part of the following business scenarios:</p> <ul style="list-style-type: none">□ Add a link for a settlement restriction on cash [▶ 807]□ Remove a link for a settlement restriction on cash [▶ 811]□ Amend the priority for a settlement restriction on cash [▶ 809] <p>Business Functionality Document</p> <p>This screen corresponds to the following business function:</p> <ul style="list-style-type: none">□ Amend instruction (T2S.GUI.SESE.INX.0040)

Screenshot

Illustration 86: Amendment cash instruction - new screen

Field

Description

Amendment Instruction	
Referred Instruction	
Instruction Type	Shows the type of the referenced instruction. This field is already filled with 'Intra-Balance Movement'.
Actor Reference	Shows the identification of the referenced instruction assigned by the T2S actor. References for error messages: [▶ 1257] <input type="checkbox"/> MVCM958 <input type="checkbox"/> MVCP004
T2S Reference	Shows the identification of the referenced instruction to be amended assigned by T2S. References for error messages: [▶ 1257] <input type="checkbox"/> MVCM958 <input type="checkbox"/> MVCP004
T2S Dedicated Cash Account Number	Shows the unique identification for an account. This field is assigned by the account servicer using a proprietary identification scheme.
General	
Instructing Party Parent BIC	Select the parent BIC of the instructing party from the drop-down menu or search via the <i>magnifier</i> icon.

Amendment Instruction	
	<p>If the instructing party is not filled in, the instructing party informed to the back end module is the one which the user of the GUI belongs to.</p> <p>If the instructing party is filled in, the instructing party parent BIC must also be filled in.</p> <p>Required format is: max. 11 characters (SWIFT-x)</p> <p>References for error messages: [▶ 1257]</p> <ul style="list-style-type: none"> <input type="checkbox"/> MVDC026 <input type="checkbox"/> MCV107 <input type="checkbox"/> MCV232 <input type="checkbox"/> MVCP122
Instructing Party BIC	<p>Select the BIC of the instructing party from the drop-down menu or search via the <i>magnifier</i> icon.</p> <p>If the instructing party is not filled in, the instructing party informed to the back end module is the one which the user of the GUI belongs to.</p> <p>If the instructing party parent BIC is filled in, the instructing party BIC must also be filled in.</p> <p>Required format is: max. 11 characters (SWIFT-x)</p> <p>References for error messages: [▶ 1257]</p> <ul style="list-style-type: none"> <input type="checkbox"/> MCV232 <input type="checkbox"/> MVDC026 <input type="checkbox"/> MCV107 <input type="checkbox"/> MVCP122
Amendment Type	<p>Select the type of the amendment instruction from the possible values:</p> <ul style="list-style-type: none"> <input type="checkbox"/> Priority <input type="checkbox"/> Linkages <p>Reference for error message: [▶ 1257]</p> <ul style="list-style-type: none"> <input type="checkbox"/> MVCP034
Priority	
Priority	<p>Select the level of the priority of the amendment instruction from the possible values:</p> <ul style="list-style-type: none"> <input type="checkbox"/> Empty (default value)

Amendment Instruction	
	<input type="checkbox"/> Normal <input type="checkbox"/> High <input type="checkbox"/> Reserved <p>The default value is empty.</p> <p>Reference for error message: [▶ 1257]</p> <input type="checkbox"/> MVSP211 <p>This frame is only available if the amendment type is set to 'Priority'.</p>
Linkage Information	
Link/Unlink	<p>Select the type of the link requested from the possible values:</p> <input type="checkbox"/> Link <input type="checkbox"/> Unlink <p>Depending on the process performed, the linkage type is 'Link' or 'Unlink'.</p> <p>To add a link, select the type 'Link'. To remove a link, select the type 'Unlink'.</p> <p>This frame is only available if the amendment type is set to 'Linkage Information'.</p> <p>References for error messages: [▶ 1257]</p> <input type="checkbox"/> MVCM958 <input type="checkbox"/> MVCM960 <input type="checkbox"/> MVLI871
Link	
Link Type	<p>Select the processing position of the link from the possible values:</p> <input type="checkbox"/> After <input type="checkbox"/> Before <input type="checkbox"/> With <p>References for error messages: [▶ 1257]</p> <input type="checkbox"/> MVLI809 <input type="checkbox"/> MVLI810 <input type="checkbox"/> MVLI811

Amendment Instruction	
	<ul style="list-style-type: none"> <input type="checkbox"/> MVL1825 <input type="checkbox"/> MVL1826 <input type="checkbox"/> MVL1827 <input type="checkbox"/> MVL1828 <input type="checkbox"/> MVL1829 <input type="checkbox"/> MVL1830 <input type="checkbox"/> MVL1837 <input type="checkbox"/> MVL1838 <input type="checkbox"/> MVL1839 <input type="checkbox"/> MVL1852 <input type="checkbox"/> MVL1855 <input type="checkbox"/> MVL1858 <input type="checkbox"/> MVL1861 <input type="checkbox"/> MVL1874 <input type="checkbox"/> MVCP042 <p>This frame is only available if the amendment type is set to 'Linkage Information'.</p> <p>This field is also available as a show field for existing records.</p>
Reference Type	<p>Select the reference type of the instruction to be linked/un-linked to from the possible values:</p> <ul style="list-style-type: none"> <input type="checkbox"/> Account Owner Settlement Instruction Reference <input type="checkbox"/> Account Owner Intra Balance Movement Reference <input type="checkbox"/> Account Owner Intra Position Movement Reference <input type="checkbox"/> Account Servicer Reference <input type="checkbox"/> Third Party reference <input type="checkbox"/> T2S Reference <p>Reference for error message: [1257]</p> <ul style="list-style-type: none"> <input type="checkbox"/> MVCP099 <p>This frame is only available if the amendment type is set to 'Linkage Information'.</p> <p>This field is also available as a show field for existing records.</p>

Amendment Instruction	
Reference	<p>Enter the identification of the instruction to be linked/unlinked to.</p> <p>Required format is: max. 16 characters (SWIFT-x-red)</p> <p>References for error messages: [▶ 1257]</p> <ul style="list-style-type: none"> <input type="checkbox"/> MVCM960 <input type="checkbox"/> MVCP099 <input type="checkbox"/> MVLI852 <input type="checkbox"/> MVLI855 <input type="checkbox"/> MVLI858 <input type="checkbox"/> MVLI861 <input type="checkbox"/> MVLI871 <input type="checkbox"/> MVLI874 <p>This frame is only available if the amendment type is set to 'Linkage Information'.</p> <p>This field is also available as a show field for existing records.</p>
Reference Owner	<p>Enter the BIC of the instructing party of the instruction to be linked/unlinked to.</p> <p>Required format is: max. 11 characters (SWIFT-x)</p> <p>If the 'Reference Type' is set to 'T2S Reference' this field is not filled in.</p> <p>This frame is only available if the amendment type is set to 'Linkage Information'.</p> <p>This field is also available as a show field for existing records.</p>
Options	<p>Information on functions (icons) can be found in Common Buttons and Icons [▶ 43].</p>

Buttons

Buttons	
Submit	<p>This function enables you to create a new cash amendment instruction. Upon clicking on the <i>submit</i> button you will be asked to enter your PIN for digital signature purposes (NRO). With the entry of the PIN, T2S attaches a digital signature to the instruction entered by the T2S actor.</p> <p>Next screen:</p>

Intra-balance movements– search/list screen [▶ 423]

References for error messages: [▶ 1257]

- MMIA002
- MMIA004
- MMIA006
- MVCM956
- MVCM958
- MVCM960
- MVCP004
- MVCP042
- MVCP099
- MVCP122
- MVCV107
- MVCV108
- MVCV232
- MVDC026
- MVLI809
- MVLI810
- MVLI811
- MVLI825
- MVLI826
- MVLI827
- MVLI828
- MVLI829
- MVLI830
- MVLI837
- MVLI838
- MVLI839
- MVLI852
- MVLI855
- MVLI858
- MVLI861

	<input type="checkbox"/> MVL1871 <input type="checkbox"/> MVL1874 <input type="checkbox"/> MVSP211
Reset	<p>This function enables you to set all fields to default value and blanks out all optional fields.</p> <p>Next screen:</p> <input type="checkbox"/> <i>Amendment cash instruction - new screen</i>
Cancel	<p>This function enables you to cancel the process and return to the previous screen.</p> <p>Next screen:</p> <input type="checkbox"/> <i>Intra-balance movement – details screen</i> [▶ 430]

2.3.3.3 Cancellation Cash Instruction - Details Screen

Context of Usage

This screen displays detailed information on the selected cancellation cash instruction. You can check the data and proceed further by clicking on the buttons below.

This screen is not relevant for CSD users.

Screen Access

Cash >> Settlement >> Maintenance Cash Instructions >> *Maintenance cash instructions – search/list* screen >> Click on the *search* button >> *Maintenance cash instructions – search/list* screen >> Click on the *details* button

Privileges

To use this screen, you need the following privilege [▶ 1206]:

Cancellation instruction for intra-balance movement audit trail details query

References

User Instructions Part

This screen is part of the following business scenario:

View cancellation instruction for a settlement restriction on cash details [▶ 819]

Business Functionality Document

This screen corresponds to the following business function:

Display instruction details (T2S.GUI.SESE.INX.0030)

Screenshot

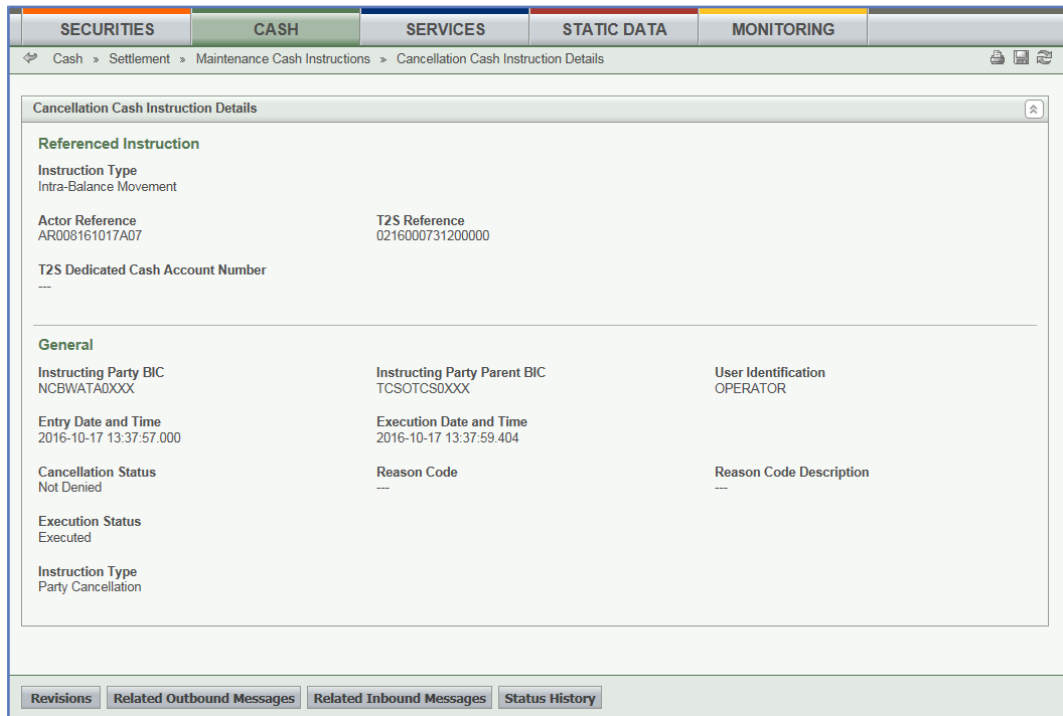

Illustration 87: Cancellation cash instruction - details screen

Field

Description

Cancellation Instruction	
Referenced Instruction	
Instruction Type	Shows the type of instruction referenced by the cancellation cash instruction. The only possible value is 'Intra-Balance Movement'.
Actor Reference	Shows the reference assigned by the T2S actor to the settlement restriction on cash.
T2S Reference	Shows the identification of the reference assigned for a settlement restriction on cash by T2S.
T2S Dedicated Cash Account Number	Shows the unique reference for the cash account used by the settlement restriction on cash.
General	
Instructing Party BIC	Shows the BIC of the instructing party.
Instructing Party Parent BIC	Shows the parent BIC of the instructing party.
User Identification	Shows user identification of the sending party.
Entry Date and Time	Shows the date and time when the cancellation instruction has entered in T2S. Displayed format is: YYYY-MM-DD hh:mm:ss:µsµsµsµsµs

Cancellation Instruction	
Execution Date and Time	Shows the date and time when the cancellation instruction has been executed. Displayed format is: YYYY-MM-DD hh:mm:ss:μsμsμsμsμs
Cancellation Status	Shows the cancellation status of the cancellation instruction from the possible values: <input type="checkbox"/> Denied <input type="checkbox"/> Not denied If the 'Reason Code' field is filled in, the cancellation status is set to 'Denied'.
Reason Code	Shows the reason code that informs the reasoning why the cancellation instruction has been denied.
Reason Code Description	Shows the description of the reasoning why the cancellation instruction has been denied.
Execution Status	Shows the execution status of the cancellation instruction from the possible values: <input type="checkbox"/> Executed <input type="checkbox"/> Not executed
Instruction Type	Shows the cancellation instruction type of the cancellation instruction.

Buttons

Revisions	This function enables you to display the revisions of the selected cancellation instruction. Next screen: <input type="checkbox"/> <i>Revisions/audit trail – list</i> screen [▶ 662]
Related Outbound Messages	This function enables you to display the outbound messages related to the cancellation instruction. In case the cancellation instruction is linked to more than one outbound message, the <i>outbound messages - search/list</i> screen is displayed. In case the query returns only one valid message, the <i>outbound message – details</i> screen is displayed directly. Next screens: <input type="checkbox"/> <i>Outbound messages – search/list</i> screen [▶ 646] <input type="checkbox"/> <i>Outbound message – details</i> screen [▶ 654]

Related Inbound Messages	<p>This function enables you to display the inbound message related to the cancellation instruction.</p> <p>In case the cancellation instruction is linked to more than one inbound message, the <i>inbound messages -search/list</i> screen is displayed.</p> <p>In case the query returns only one valid message, the <i>inbound outbound message – details</i> screen is displayed directly.</p> <p>Next screens:</p> <ul style="list-style-type: none"> <input type="checkbox"/> <i>Inbound messages – search/list</i> screen [▶ 629] <input type="checkbox"/> <i>Inbound message – details</i> screen [▶ 636]
Status History	<p>This function enables you to display the status history of the selected cancellation instruction.</p> <p>Next screen:</p> <ul style="list-style-type: none"> <input type="checkbox"/> <i>Status history – details</i> screen [▶ 267]

2.3.3.4 Cancellation Cash Instruction - New Screen

Context of Usage

This screen contains a number of fields regarding cancellation cash instructions. You can enter new data. Afterwards you can proceed further by clicking on the buttons below.

You can use this screen either in 2-eyes or in 4-eyes mode.

This screen is not relevant for CSD users.

Screen Access

Cash >> Settlement >> Intra-Balance Movements >> *Intra-balance movements – search/list* screen >> Click on the *search* button >> *Intra-balance movements – search/list* screen >> Click on the *details* button >> *Intra-balance movement - details* screen >> Click on the *cancellation instruction* button

Privileges

To use this screen you need the following privileges [▶ 1207]:

- Cancel settlement restriction on cash on a dedicated cash account
- Send new instruction using a specific instructing party

References

User Instructions Part

This screen is part of the following business scenario:

- Cancel a settlement restriction on cash [▶ 818]

Business Functionality Document

This screen corresponds to the following business function:

Cancel instruction (T2S.GUI.SESE.INX.0050)

Screenshot

Illustration 88: Cancellation cash instruction - new screen

Field

Description

Cancellation Instruction	
Referenced Instruction	
Referenced Instruction	Shows the type of the referenced instruction. This field is already filled in with 'Intra-Balance Movement'.
Actor Reference	Shows the identification of the referenced instruction assigned by the T2S actor.
T2S Reference	Shows the identification of the referenced instruction to be amended assigned by T2S. Reference for error message [▶ 1286]: <input type="checkbox"/> MVCP003
T2S Dedicated Cash Account	Shows the T2S dedicated cash account of the referenced instruction. Reference for error message [▶ 1286]: <input type="checkbox"/> MVCP035
General	
Instructing Party Parent BIC	Select the parent BIC of the instructing party from the drop-down menu or search via the <i>magnifier</i> icon. In case the instructing party is not entered, the instructing party informed to the back end module will be the party you belong to. If the 'Instructing Party Parent BIC' is filled in, the 'Instructing Party BIC' has to be filled in too. Required format is: max. 11 characters (SWIFT-x) References for error messages [▶ 1286]:

Cancellation Instruction	
	<ul style="list-style-type: none"> <input type="checkbox"/> MVCV231 <input type="checkbox"/> MVCV108 <input type="checkbox"/> MVCP123 <input type="checkbox"/> MVDC027
Instructing Party BIC	<p>Select the BIC of the instructing party from the drop-down menu or search via the <i>magnifier</i> icon.</p> <p>In case the instructing party is not entered, the instructing party informed to the back end module will be the party you belong to. If the 'Instructing Party BIC' is filled in, the 'Instructing Party Parent BIC' has to be filled in too'</p> <p>Required format is: max. 11 characters (SWIFT-x)</p> <p>References for error messages [▶ 1286]:</p> <ul style="list-style-type: none"> <input type="checkbox"/> MVCV231 <input type="checkbox"/> MVCV108 <input type="checkbox"/> MVCP123 <input type="checkbox"/> MVDC027

Buttons

Submit	<p>This function enables you to create a new cancellation cash instruction. Upon clicking on the <i>submit</i> button you will be asked to enter your PIN for digital signature purposes (NRO). With the entry of the PIN, T2S attaches a digital signature to the instruction entered by the T2S actor.</p> <p>Next screen:</p> <ul style="list-style-type: none"> <input type="checkbox"/> <i>Intra-balance movements with current and historical status – search</i> screen [▶ 423] <p>References for error messages [▶ 1286]:</p> <ul style="list-style-type: none"> <input type="checkbox"/> MVDC027 <input type="checkbox"/> MMCR201 <input type="checkbox"/> MMCR202 <input type="checkbox"/> MVCP003 <input type="checkbox"/> MVCP035 <input type="checkbox"/> MVCP123 <input type="checkbox"/> MVCV108 <input type="checkbox"/> MVCV231

Cancel	<p>This function enables you to cancel the process and return to the previous screen.</p> <p>Next screen:</p> <ul style="list-style-type: none"> <input type="checkbox"/> <i>Intra-balance movement - details</i> screen [▶ 430]
Reset	<p>This function enables you to set all fields to default value and blanks out all optional criteria.</p> <p>Next screen:</p> <ul style="list-style-type: none"> <input type="checkbox"/> <i>Cancellation cash instruction - new</i> screen

2.3.3.5 Intra-Balance Movements - Search/List Screen

Context of Usage

This screen contains a number of search fields. By inputting the relevant data, you can search for settlement restrictions on cash. The search results will be displayed in a list. After selecting an entry, you can proceed further by clicking on the buttons below.

When exporting the content of this screen, you receive the list and the corresponding details for each data record.

This screen is not relevant for CSD users.

Screen Access

Cash >> Settlement >> Intra-Balance Movements >> *Intra-balance movements– search/list* screen

Privileges

To use this screen, you need the following privilege [▶ 1216]:

Intra-balance movements query

References

User Instructions Part

This screen is part of the following business scenarios:

- Add a link for a settlement restriction on cash [▶ 807]
- Amend the priority for a settlement restriction on cash [▶ 809]
- Copy a settlement restriction on cash [▶ 794]
- Cancel a settlement restriction on cash [▶ 818]
- Enter a settlement restriction on cash [▶ 792]
- Remove a link for a settlement restriction on cash [▶ 811]
- View settlement restriction on cash details [▶ 797]

Business Functionality Document

This screen corresponds to the following business function:

- Display instruction list (T2S.GUI.SESE.INX.0020)

Screenshot

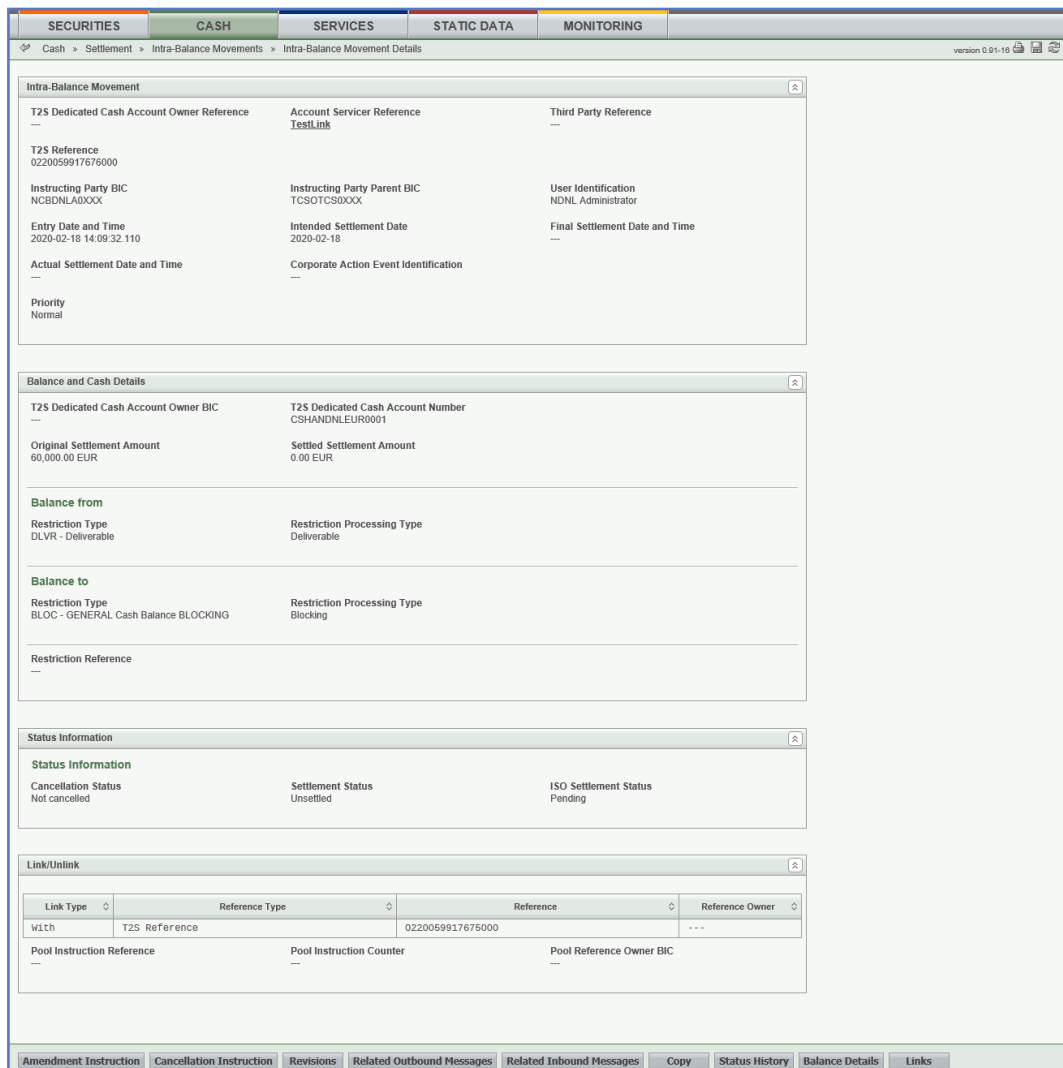

Illustration 89: Intra-balance movements - search/list screen

Field

Description

Intra-Balance Movements – Search Criteria	
General Criteria	
Actor Reference	Enter the identification assigned by the T2S actor. Required format is: max. 16 characters (SWIFT-x)
T2S Reference	Enter the identification of the settlement restriction assigned by T2S. Required format is: max. 16 characters (SWIFT-x)
Account Owner Reference	Enter the identification of the settlement restriction assigned by the T2S party. Required format is: max. 16 characters (SWIFT-x)
T2S Dedicated Cash Account Number	Select the T2S dedicated cash account. Required format is: max. 34 characters (SWIFT-x) References for error messages [▶ 1341]:

Intra-Balance Movements – Search Criteria	
	<input type="checkbox"/> QMPC031 <input type="checkbox"/> QMPC072
Currency	<p>Select the currency from the drop-down menu. The default value is 'all'.</p> <p>Reference for error message [▶ 1341]:</p> <input type="checkbox"/> QMPC072
Account Servicer Reference	<p>Enter the reference of the settlement restriction assigned by the CB.</p> <p>Required format is: max. 16 characters (SWIFT-x)</p>
Third Party Reference	<p>Enter the reference of the settlement restriction assigned by a third party.</p> <p>Required format is: max. 16 characters (SWIFT-x)</p>
Instructing Party Parent BIC	<p>Select the parent BIC of the instructing party from the drop-down menu or search via the magnifier icon.</p> <p>Required format is: max. 11 characters (SWIFT-x)</p> <p>References for error messages [▶ 1341]:</p> <input type="checkbox"/> QMPC048 <input type="checkbox"/> QMPC084
Instructing Party BIC	<p>Select the BIC of the instructing party from the drop-down menu or search via the magnifier icon.</p> <p>Required format is: max. 11 characters (SWIFT-x)</p> <p>References for error messages [▶ 1341]:</p> <input type="checkbox"/> QMPC032 <input type="checkbox"/> QMPC084
T2S Dedicated Cash Account Owner	<p>You can choose to either enter the 'T2S Dedicated Cash Account Owner' or to select it from the suggested items in the drop-down menu.</p> <p>References for error messages [▶ 1341]:</p> <input type="checkbox"/> QMPC032 <input type="checkbox"/> QMPC072
Restriction Reference	<p>Enter the unique identification of the restricted cash balance.</p> <p>Required format is: max. 16 characters (SWIFT-x)</p>

Intra-Balance Movements – Search Criteria	
	Upon the settlement of the restriction, the 'Restriction Reference' is updated.
Restriction Type - Balance From	<p>You can choose to either enter the 'Restriction Type - Balance From' or to select it from the suggested items in the drop-down menu.</p> <p>The restriction type code is assigned by the CB.</p> <p>The default value is 'All'.</p> <p>All the possible values stored in SD and that are available according to the privileges will be shown</p> <p>Reference for error message [▶ 1341]:</p> <ul style="list-style-type: none"> <input type="checkbox"/> IIMP079 <p>The cash balance type of 'Balance from' must be different from the cash balance type of 'Balance to'.</p>
Restriction Type - Balance To	<p>You can choose to either enter the 'Restriction Type - Balance To' or to select it from the suggested items in the drop-down menu.</p> <p>The restriction type code is assigned by the CB.</p> <p>The default value is 'All'.</p> <p>All the possible values stored in SD and that are available according to the privileges will be shown</p> <p>Reference for error message [▶ 1341]:</p> <ul style="list-style-type: none"> <input type="checkbox"/> IIMP079 <p>The cash balance type of 'Balance from' must be different from the cash balance type of 'Balance to'.</p>
Range Criteria	
Intended Settlement Date - from	<p>Enter the date from which the instruction is eligible for settlement or use the <i>calendar</i> icon.</p> <p>Required format is: YYYY-MM-DD</p> <p>Reference for error message [▶ 1341]:</p> <ul style="list-style-type: none"> <input type="checkbox"/> QMPC012
Intended Settlement Date - to	<p>Enter the date until which the instruction is eligible for settlement or use the <i>calendar</i> icon.</p> <p>Required format is: YYYY-MM-DD</p> <p>Reference for error message [▶ 1341]:</p>

Intra-Balance Movements – Search Criteria	
	<input type="checkbox"/> QMPC012
Actual Settlement Date - from	<p>Enter the date and time from which the latest settlement occurred or use the <i>calendar</i> icon.</p> <p>Required format is: YYYY-MM-DD hh:mm:ss</p> <p>References for error messages [▶ 1341]:</p> <input type="checkbox"/> QMPC013 <input type="checkbox"/> QMPC014
Actual Settlement Date - to	<p>Enter the date and time until which the latest settlement occurred or use the <i>calendar</i> icon.</p> <p>Required format is: YYYY-MM-DD hh:mm:ss</p> <p>Reference for error message [▶ 1341]:</p> <input type="checkbox"/> QMPC014
Entry Date and Time - from	<p>Enter the lower bound of the search range for the entry date and time or use the <i>calendar</i> icon.</p> <p>Required format is: YYYY-MM-DD hh:mm:ss</p> <p>References for error messages [▶ 1341]:</p> <input type="checkbox"/> QMPC015 <input type="checkbox"/> QMPC073
Entry Date and Time - to	<p>Enter the upper bound of the search range for the entry date and time or use the <i>calendar</i> icon.</p> <p>Required format is: YYYY-MM-DD hh:mm:ss</p> <p>References for error messages [▶ 1341]:</p> <input type="checkbox"/> QMPC015 <input type="checkbox"/> QMPC095
Amount more/equal than	<p>Enter the lower bound of the search range for the amount.</p> <p>Required format is: max. 18 characters (thereof max. 5 decimal places and decimal point)</p> <p>Reference for error message [▶ 1341]:</p> <input type="checkbox"/> QMPC005
Amount less/equal than	<p>Enter the upper bound of the search range for the amount.</p> <p>Required format is: max. 18 characters (thereof max. 5 decimal places and decimal point)</p> <p>Reference for error message [▶ 1341]:</p>

Intra-Balance Movements – Search Criteria	
	<input type="checkbox"/> QMPC005
Status Criteria	
Settlement Status	<p>Select the settlement status of the settlement restriction from the possible values:</p> <ul style="list-style-type: none"> <input type="checkbox"/> All (default value) <input type="checkbox"/> Partially settled <input type="checkbox"/> Settled <input type="checkbox"/> Unsettled
ISO Settlement status	<p>Select the settlement status of the settlement restriction from the possible values:</p> <ul style="list-style-type: none"> <input type="checkbox"/> All (default value) <input type="checkbox"/> Pending <input type="checkbox"/> Failing <p>If value 'Settlement Status' field is set to 'Settled' or 'Cancellation Status' field is set to 'Cancelled', this field is disabled.</p>
Cancellation Status	<p>Select the cancellation status of the settlement restriction from the possible values:</p> <ul style="list-style-type: none"> <input type="checkbox"/> All (default value) <input type="checkbox"/> Cancelled <input type="checkbox"/> Not cancelled
Intra-Balance Movements - List	
Actor Reference	Shows the identification of the settlement restriction assigned by the T2S Actor.
Instructing Party BIC	Shows the BIC of the instructing party.
Instructing Party Parent BIC	Shows the parent BIC of the instructing party.
Dedicated Cash Account	Shows the T2S dedicated cash account.
Amount	Shows the original amount stated in the settlement restriction.
Restriction Type - Balance From	Shows the code specified by the CB to identify the restriction.
Restriction Type - Balance To	Shows the code specified by the CB to identify the restriction.

Intra-Balance Movements – Search Criteria	
Restriction Reference	Shows the unique identification of a restricted position. Upon the settlement of the restriction, the 'Restriction Reference' is updated.
Settlement Status	Shows the current settlement status of the settlement restriction from the possible values: <ul style="list-style-type: none"> <input type="checkbox"/> Unsettled <input type="checkbox"/> Settled <input type="checkbox"/> Partially settled
Cancellation Status	Shows the current cancellation status of the settlement restriction from the possible values: <ul style="list-style-type: none"> <input type="checkbox"/> Cancelled <input type="checkbox"/> Not cancelled

Buttons

Buttons	
Search	<p>This function enables you to start a search according to the criteria entered. The results are displayed in a list on the next screen.</p> <p>If the search retrieves a single record, the <i>details</i> screen is displayed directly.</p> <p>Next screens:</p> <ul style="list-style-type: none"> <input type="checkbox"/> <i>Intra-balance movements – search/list</i> screen <input type="checkbox"/> <i>Intra-balance movement – details</i> screen [▶ 430] <p>References for error messages [▶ 1341]:</p> <ul style="list-style-type: none"> <input type="checkbox"/> QMPC005 <input type="checkbox"/> QMPC012 <input type="checkbox"/> QMPC013 <input type="checkbox"/> QMPC014 <input type="checkbox"/> QMPC015 <input type="checkbox"/> QMPC031 <input type="checkbox"/> QMPC032 <input type="checkbox"/> QMPC048 <input type="checkbox"/> QMPC072 <input type="checkbox"/> QMPC073 <input type="checkbox"/> QMPC084

Intra-Balance Movement - Details Screen	
	<input type="checkbox"/> QMPC095
Reset	This function enables you to set default search criteria and blanks out all optional criteria. Next screen: <input type="checkbox"/> <i>Intra-balance movements– search/list</i> screen
New	This function enables you to create a new settlement restriction on cash. Next screen: <input type="checkbox"/> <i>Intra-balance movement – new</i> screen [▶ 437]
Details	This function enables you to display the details of the selected settlement restriction on cash. Next screen: <input type="checkbox"/> <i>Intra-balance movement – details</i> screen [▶ 430]

2.3.3.6 Intra-Balance Movement - Details Screen

Context of Usage

This screen displays detailed information on the selected settlement restriction on cash. You can check the data and proceed further by clicking on the buttons below.

This screen is not relevant for CSD users.

Screen Access

Cash >> Settlement >> Intra-Balance Movements >> *Intra-balance movements– search/list* screen >> Click on the *search* button >> *Intra-balance movements – search/list* screen >> Click on the *details* button

Privileges

To use this screen, you need the following privilege [▶ 1215]:

Intra balance movement audit trail list query

References

User Instructions Part

This screen is part of the following business scenarios:

- Add a link for a settlement restriction on cash [▶ 807]
- Amend the priority for a settlement restriction on cash [▶ 809]
- Copy a settlement restriction on cash [▶ 794]
- Cancel a settlement restriction on cash [▶ 818]
- Remove a link for a settlement restriction on cash [▶ 811]
- View settlement restriction on cash details [▶ 797]

Business Functionality Document

This screen corresponds to the following business function:

Display instruction details (T2S.GUI.SESE.INX.0030)

Screenshot

The screenshot displays the 'Intra-Balance Movement Details' screen with the following sections:

- Intra-Balance Movement:**
 - T2S Dedicated Cash Account Owner Reference: ---
 - Account Servicer Reference: CbicF1906061323
 - Third Party Reference: ---
 - T2S Reference: 0219050582084000
 - Instructing Party BIC: NCBKDEFFQ01
 - Instructing Party Parent BIC: TCSOTCS0XXX
 - User Identification: User with all Privileges in Four-Eyes-Mode
 - Entry Date and Time: 2019-06-06 13:23:33.331
 - Intended Settlement Date: 2019-06-13
 - Final Settlement Date and Time: ---
 - Actual Settlement Date and Time: ---
 - Corporate Action Event Identification: ---
 - Priority: Normal
- Balance and Cash Details:**
 - T2S Dedicated Cash Account Owner BIC: ---
 - T2S Dedicated Cash Account Number: DCAD4ULI04
 - Original Settlement Amount: 500.00 EUR
 - Settled Settlement Amount: 0.00 EUR
 - Balance from:
 - Restriction Type: BALC - DELIVERABLE
 - Restriction Processing Type: Balance Type/Earmarking
 - Balance to:
 - Restriction Type: DLVR - Deliverable
 - Restriction Processing Type: Deliverable
 - Restriction Reference: ---
- Status Information:**
 - Cancellation Status: Not cancelled
 - Settlement Status: Unsettled
 - ISO Settlement Status: Pending
- Link/Unlink:**
 - Link Type: ---
 - Reference Type: ---
 - Reference: ---
 - Reference Owner: ---
 - No records found.
 - Pool Instruction Reference: ---
 - Pool Instruction Counter: ---
 - Pool Reference Owner BIC: ---

Buttons at the bottom: Amendment Instruction, Cancellation Instruction, Revisions, Related Outbound Messages, Related Inbound Messages, Copy, Status History, Balance Details.

Illustration 90: Intra-balance movement - details screen

Field

Description

Intra-Balance Movement	
T2S Dedicated Cash Account Owner Reference	Shows the identification of the settlement restriction assigned by the instructing party. Only one field among 'T2S Dedicated Cash Account Owner Reference', 'Account Servicer Reference' or 'Third Party Reference' is filled in.
Account Servicer Reference	Shows the identification of the settlement restriction assigned by the CB.

Intra-Balance Movement	
	Only one field among 'T2S Dedicated Cash Account Owner Reference', 'Account Servicer Reference' or 'Third Party Reference' is filled in.
Third Party Reference	Shows the identification of the settlement restriction assigned by a third party. Only one field among 'T2S Dedicated Cash Account Owner Reference', 'Account Servicer Reference' or 'Third Party Reference' is filled in.
Reference	Shows the identification of the settlement restriction assigned by T2S.
Instructing Party BIC	Shows the BIC of the instructing party.
Instructing Party Parent BIC	Shows the parent BIC of the instructing party.
User Identification	Shows the user identification of the sending party.
Entry Date and Time	Shows the timestamp when the instruction is entered in T2S. Displayed format is: YYYY-MM-DD hh:mm:ss:µsµsµsµsµs
Intended Settlement Date	Shows the date when the instruction is eligible for settlement. Displayed format is: YYYY-MM-DD
Final Settlement Date and Time	Shows the business date and the calendar time when the settlement restriction is settled totally. Displayed format is: YYYY-MM-DD hh:mm:ss:µsµsµsµsµs
Actual Settlement Date and Time	Shows the business date and the calendar time when the last settlement occurred (partially or totally). Displayed format is: YYYY-MM-DD hh:mm:ss:µsµsµsµsµs
Priority	Shows the priority of the settlement restriction from the possible values: <input type="checkbox"/> Normal <input type="checkbox"/> High <input type="checkbox"/> Reserved
Balance and Cash Details	
T2S Dedicated Cash Account Owner BIC	Shows the BIC of the owner of the securities account.

Intra-Balance Movement	
T2S Dedicated Cash Account Number	Shows the T2S dedicated cash account used in the settlement restriction.
Original Settlement Amount	Shows the original amount stated in the settlement restriction.
Settled Settlement Amount	Shows the settled amount of the settlement restriction.
Balance from	
Restriction Type	Shows the code defined in reference data to identify the restriction from which the cash have to be restricted/unrestricted.
Restriction Processing Type	Shows the type of processing T2S shall apply for the restriction from the possible values: <ul style="list-style-type: none"> <input type="checkbox"/> Rejection <input type="checkbox"/> Reservation <input type="checkbox"/> Blocking <input type="checkbox"/> Earmarking for auto-collateralisation <input type="checkbox"/> Deliverable <input type="checkbox"/> CoSD blocking
Balance to	
Restriction Type	Shows the code defined in reference data to identify the restriction to which the cash have to be restricted/unrestricted.
Restriction Processing Type	Shows the type of processing T2S shall apply for the restriction from the possible values: <ul style="list-style-type: none"> <input type="checkbox"/> Rejection <input type="checkbox"/> Reservation <input type="checkbox"/> Blocking <input type="checkbox"/> Earmarking for auto-collateralisation <input type="checkbox"/> Deliverable <input type="checkbox"/> CoSD blocking
Restriction Reference	Shows the unique identification of the restricted cash balance. Upon the settlement of the restriction, the 'Restriction Reference' is updated.
Status Information	

Intra-Balance Movement	
Status Information	
Cancellation Status	Shows the current cancellation status of the settlement restriction from the possible values: <ul style="list-style-type: none"> <input type="checkbox"/> Cancelled <input type="checkbox"/> Not cancelled
Settlement Status	Shows the current settlement status of the settlement restriction from the possible values: <ul style="list-style-type: none"> <input type="checkbox"/> Settled <input type="checkbox"/> Unsettled <input type="checkbox"/> Partially settled
ISO Settlement Status	Shows the current ISO settlement status of the settlement restriction from the possible values: <ul style="list-style-type: none"> <input type="checkbox"/> Pending <input type="checkbox"/> Failing
Link	
Link Type	Shows the type of link of the instruction, the restriction is linked with from the possible values: <ul style="list-style-type: none"> <input type="checkbox"/> After <input type="checkbox"/> Before <input type="checkbox"/> With <input type="checkbox"/> Info
Reference Type	Shows the reference type of the instruction to be linked/unlinked to from the possible values: <ul style="list-style-type: none"> <input type="checkbox"/> Account Owner Settlement Instruction Reference <input type="checkbox"/> Account Owner Settlement Instruction Reference <input type="checkbox"/> Account Owner Intra Balance Movement Reference <input type="checkbox"/> Account Owner Intra Position Movement Reference <input type="checkbox"/> Account Servicer Reference <input type="checkbox"/> Third Party reference <input type="checkbox"/> T2S reference
Reference	Shows the identification of the instruction to be linked/unlinked to.
Reference Owner	Shows the BIC of the instructing party of the instruction to be linked/unlinked to.

Intra-Balance Movement	
	This field is only filled in if the 'Reference Type' is set to any value different than 'T2S reference'.
Pool Instruction Reference	Shows the collective reference identifying a set of messages.
Pool Instruction Counter	Shows the maximum number of instructions included in the pool.
Pool Reference Owner BIC	Shows the BIC of the owner of the Pool Instruction Reference

Buttons

Amendment Instruction	<p>This function enables you to create a new amendment instruction for the selected settlement restriction on cash.</p> <p>This button is not available in case any status of the settlement restriction on cash does not allow the creation of the amendment instruction.</p> <p>Next screen:</p> <ul style="list-style-type: none"> <input type="checkbox"/> <i>Amendment cash instruction - new</i> screen [410]
Cancellation Instruction	<p>This function enables you to create a new cancellation instruction for the selected settlement restriction on cash.</p> <p>This button is not available in case any status of the settlement restriction on cash does not allow the creation of the cancellation instruction.</p> <p>Next screen:</p> <ul style="list-style-type: none"> <input type="checkbox"/> <i>Cancellation cash instruction - new</i> screen [420]
Revisions	<p>This function enables you to display the revisions of the selected settlement restriction on cash.</p> <p>Next screen:</p> <ul style="list-style-type: none"> <input type="checkbox"/> <i>Revisions/audit trail – details</i> screen [662]
Related Outbound Messages	<p>This function enables you to display the outbound messages related to the selected settlement restriction on cash.</p> <p>Next screens:</p> <ul style="list-style-type: none"> <input type="checkbox"/> <i>Outbound messages – search/list</i> screen [646] (if the settlement restriction on cash is linked to more than one outbound message)

	<ul style="list-style-type: none">□ <i>Outbound message – details</i> screen [▶ 654] (if the settlement restriction on cash is linked to one outbound message only)
Related Inbound Messages	<p>This function enables you to display the inbound message related to the selected settlement restriction on cash.</p> <p>Next screens:</p> <ul style="list-style-type: none">□ <i>Inbound messages – search/list</i> screen [▶ 629] (if the settlement restriction on cash is linked to more than one inbound message)□ <i>Inbound message – details</i> screen [▶ 636] (if the settlement restriction on cash is linked to one inbound message only)
Copy Instruction	<p>This function enables you to copy fields to create a new settlement restriction on cash with the same attributes.</p> <p>Next screen:</p> <ul style="list-style-type: none">□ <i>Intra-balance movement – new</i> screen [▶ 437]
Status History	<p>This function enables you to display the status history of the selected settlement restriction on cash.</p> <p>Next screen:</p> <ul style="list-style-type: none">□ <i>Status history – details</i> screen [▶ 267]
Cash Balance Details	<p>This function enables you to display the cash balance details related to the selected settlement restriction on cash.</p> <p>Next screen:</p> <ul style="list-style-type: none">□ <i>T2S DCA balance - details</i> screen [▶ 362]
Links	<p>This function enables you to display all the links data preventing settlement at the moment when the request is performed.</p> <p>This button is not available in the following cases:</p> <ul style="list-style-type: none">□ Cancellation Status = “cancelled”□ Settlement Status = “settled” <p>Next screen:</p> <ul style="list-style-type: none">□ <i>Links Preventing Settlement -</i> screen [▶ 277]

2.3.3.7 Intra-Balance Movement - New Screen

Context of Usage	<p>This screen contains a number of fields regarding settlement restrictions on cash (intra-balance movements). You can enter new data. Afterwards you can proceed further by clicking on the buttons below.</p> <p>You can use this screen either in 2-eyes or in 4-eyes mode.</p> <p>This screen is not relevant for CSD users.</p>
Screen Access	<ul style="list-style-type: none"><input type="checkbox"/> Cash >> Settlement >> Intra-Balance Movements >> <i>Intra-balance movements with current and historical status – search</i> screen >> Click on the <i>new</i> button<input type="checkbox"/> Cash >> Settlement >> Intra-Balance Movements >> <i>Intra-balance movements with current and historical status – search</i> screen >> Click on the <i>search</i> button >> <i>Intra-balance movements – list</i> screen >> Click on the <i>details</i> button >> <i>Intra-balance movement – details</i> screen >> Click on the <i>copy</i> button<input type="checkbox"/> Cash >> Cash Account >> Cash Account Balances >> <i>T2S DCA balances – search/list</i> screen >> Click on the <i>create intra balance movement</i> button
Privileges	<p>To use this screen, you need the following privileges [▶ 1216]:</p> <ul style="list-style-type: none"><input type="checkbox"/> Send new settlement restriction on cash on a dedicated cash account<input type="checkbox"/> Link to an instruction/pool reference belonging to a specific party<input type="checkbox"/> Unblock CoSD cash blocking related to cancelled CoSD settlement instructions on behalf of the relevant CSD in T2S<input type="checkbox"/> Send new instruction using a specific instructing party
References	<p>User Instructions Part</p> <p>This screen is part of the following business scenarios:</p> <ul style="list-style-type: none"><input type="checkbox"/> Enter a settlement restriction on cash [▶ 792]<input type="checkbox"/> Copy a settlement restriction on cash [▶ 794] <p>Business Functionality Document</p> <p>This screen corresponds to the following business function:</p> <ul style="list-style-type: none"><input type="checkbox"/> Add settlement instruction or settlement restriction (T2S.GUI.SESE.INX.0070)

Screenshot

Illustration 91: Intra-balance movement - new screen

Field Description

Intra-Balance Movement	
Actor Reference*	<p>Enter the identification of the T2S actor.</p> <p>Required format is: max. 16 characters (SWIFT-x-red)</p> <p>References for error messages [▶ 1322]:</p> <ul style="list-style-type: none"> <input type="checkbox"/> MVDC003 <input type="checkbox"/> MVDC005 <input type="checkbox"/> MVDC007 <input type="checkbox"/> MVDC015 <input type="checkbox"/> MVDC017 <input type="checkbox"/> MVDC019 <input type="checkbox"/> MVDC022 <input type="checkbox"/> MVDC023 <input type="checkbox"/> MVS705 <input type="checkbox"/> MVS708
Instructing Party Parent BIC	Select the parent BIC of the instructing party from the drop-down menu or search via the <i>magnifier</i> icon.

Intra-Balance Movement	
	<p>Required format is: max. 11 characters (SWIFT-x)</p> <p>References for error messages [▶ 1322]:</p> <ul style="list-style-type: none"> <input type="checkbox"/> MVCV110 <input type="checkbox"/> MVCV230 <input type="checkbox"/> MVDC025 <input type="checkbox"/> MVCP120 <input type="checkbox"/> MVCV291 <input type="checkbox"/> MVDC003 <input type="checkbox"/> MVDC005 <input type="checkbox"/> MVDC007 <input type="checkbox"/> MVDC015 <input type="checkbox"/> MVDC017 <input type="checkbox"/> MVDC019 <input type="checkbox"/> MVDC022 <input type="checkbox"/> MVDC023 <input type="checkbox"/> MVLI868 <p>In case the instructing party is not entered, the instructing party informed to the back end module will be the party you belong to. If the Instructing Party parent BIC is filled in, the Instructing Party BIC has to be filled in too.</p>
Instructing Party BIC	<p>Select the BIC of the instructing party from the drop-down menu or search via the <i>magnifier</i> icon.</p> <p>Required format is: max. 11 characters (SWIFT-x)</p> <p>References for error messages [▶ 1322]:</p> <ul style="list-style-type: none"> <input type="checkbox"/> MVCV110 <input type="checkbox"/> MVCV230 <input type="checkbox"/> MVDC003 <input type="checkbox"/> MVDC005 <input type="checkbox"/> MVDC007 <input type="checkbox"/> MVDC015 <input type="checkbox"/> MVDC017 <input type="checkbox"/> MVDC019 <input type="checkbox"/> MVDC022

Intra-Balance Movement	
	<input type="checkbox"/> MVDC023 <input type="checkbox"/> MVDC025 <input type="checkbox"/> MVCP120 <input type="checkbox"/> MVLI868 In case the instructing party is not entered, the instructing party informed to the back end module will be the party you belong to. If the Instructing Party BIC is filled in, the Instructing Party Parent BIC has to be filled in too.
Intended Settlement Date*	Enter the date from which the instruction becomes eligible to be submitted to settlement or use the <i>calendar</i> icon. Required format is: YYYY-MM-DD References for error messages [1322]: <input type="checkbox"/> MVCA508 <input type="checkbox"/> MVLI819 <input type="checkbox"/> MVLI820 <input type="checkbox"/> MVLI821 <input type="checkbox"/> MVLI822 <input type="checkbox"/> MVLI823 <input type="checkbox"/> MVLI824 <input type="checkbox"/> MVLI835 <input type="checkbox"/> MVLI836 <input type="checkbox"/> MVRR903 <input type="checkbox"/> MVRR989 <input type="checkbox"/> MVSD404 <input type="checkbox"/> MCVV110 <input type="checkbox"/> MCVV230 <input type="checkbox"/> MVLI834
Corporate Action Event	Enter the identification assigned by the account servicer to unambiguously identify a corporate action event. Required format is: max. 16 characters (SWIFT-x-red)
Priority	Select the level of priority assigned to the instruction from the possible values: <input type="checkbox"/> Empty (default value)

Intra-Balance Movement	
	<input type="checkbox"/> Normal <input type="checkbox"/> High <input type="checkbox"/> Reserved Reference for error message [▶ 1322]: <input type="checkbox"/> MVSP212
T2S Dedicated Cash Account Number*	Select the T2S dedicated cash account from the drop-down menu. References for error messages [▶ 1322]: <input type="checkbox"/> MVCA508 <input type="checkbox"/> MVCA512 <input type="checkbox"/> MVCP017 <input type="checkbox"/> MCV291 <input type="checkbox"/> MCV292 <input type="checkbox"/> MVRR925 <input type="checkbox"/> MVCP045
Amount*	Enter the amount stated in the instruction. Required format is: max. 15 digit(s) incl. decimal point (thereof max. 5 decimal places) References for error messages [▶ 1322]: <input type="checkbox"/> MVCU108 <input type="checkbox"/> MCV255 <input type="checkbox"/> MVCA106 <input type="checkbox"/> MVSD404
T2S Dedicated Cash Account Owner	Enter the BIC of the T2S dedicated cash account owner. Required format is: max. 11 characters (SWIFT-x) Reference for error message [▶ 1322]: <input type="checkbox"/> MVCA512
Currency	Shows the currency stated in the instruction obtained from the dedicated cash account. It is automatically filled in when the T2S Dedicated Cash Account Number is selected. References for error messages [▶ 1322]: <input type="checkbox"/> MVCU102

Intra-Balance Movement	
	<input type="checkbox"/> MVCU104 <input type="checkbox"/> MVCA106 <input type="checkbox"/> MVSD404
Restriction Type - Balance From*	<p>You can choose to either enter the 'Restriction Type - Balance From' or to select it from the suggested items in the drop-down menu.</p> <p>This field also contains a description of the restriction.</p> <p>References for error messages [▶ 1322]:</p> <input type="checkbox"/> MVRR901 <input type="checkbox"/> MVRR905 <input type="checkbox"/> MVRR906 <input type="checkbox"/> MVRR910 <input type="checkbox"/> MVRR917 <input type="checkbox"/> MVRR924 <input type="checkbox"/> MVRR993 <input type="checkbox"/> MVRR994 <input type="checkbox"/> MVCP098
Restriction Type - Balance To*	<p>You can choose to either enter the 'Restriction Type - Balance To' or to select it from the suggested items in the drop-down menu.</p> <p>This field also contains a description of the restriction.</p> <p>References for error messages [▶ 1322]:</p> <input type="checkbox"/> MVRR905 <input type="checkbox"/> MVRR906 <input type="checkbox"/> MVRR910 <input type="checkbox"/> MVRR916 <input type="checkbox"/> MVRR924 <input type="checkbox"/> MVRR989 <input type="checkbox"/> MVRR992 <input type="checkbox"/> MVRR993 <input type="checkbox"/> MVRR994
Restriction Reference	<p>Enter the identification of the restriction applying on cash.</p> <p>Required format is: max. 16 characters (SWIFT-x-red)</p>

Intra-Balance Movement	
	References for error messages [▶ 1322]: <input type="checkbox"/> MVRR918 <input type="checkbox"/> MVRR924 <input type="checkbox"/> MVRR925 <input type="checkbox"/> MVRR978 <input type="checkbox"/> MVRR994
Link	
Link Type	Select a link processing position from the possible values: <input type="checkbox"/> After (default value) <input type="checkbox"/> Before <input type="checkbox"/> With References for error messages [▶ 1322]: <input type="checkbox"/> MVCP018 <input type="checkbox"/> MVLI805 <input type="checkbox"/> MVLI806 <input type="checkbox"/> MVLI807 <input type="checkbox"/> MVLI819 <input type="checkbox"/> MVLI820 <input type="checkbox"/> MVLI821 <input type="checkbox"/> MVLI822 <input type="checkbox"/> MVLI823 <input type="checkbox"/> MVLI824 <input type="checkbox"/> MVLI834 <input type="checkbox"/> MVLI835 <input type="checkbox"/> MVLI836 <input type="checkbox"/> MVLI852 <input type="checkbox"/> MVLI855 <input type="checkbox"/> MVLI858 <input type="checkbox"/> MVLI861 <input type="checkbox"/> MVLI864 <input type="checkbox"/> MVLI866 <input type="checkbox"/> MVLI873

Intra-Balance Movement	
	<input type="checkbox"/> MVL1876 This field is also available as a show field for existing records.
Reference Type	Select the reference type of the instruction to be linked/unlinked to from the possible values: <ul style="list-style-type: none"> <input type="checkbox"/> Account Owner Settlement Instruction Reference <input type="checkbox"/> Account Owner Settlement Instruction Reference <input type="checkbox"/> Account Owner Intra Balance Movement Reference <input type="checkbox"/> Account Owner Intra Position Movement Reference <input type="checkbox"/> Account Servicer Reference <input type="checkbox"/> Third Party reference <input type="checkbox"/> T2S reference Required format is: max. 35 characters (SWIFT-x) Reference for error message [▶ 1322]: <ul style="list-style-type: none"> <input type="checkbox"/> MVCP099 This field is also available as a show field for existing records.
Reference	Enter the identification of the instruction to be linked/unlinked to. Required format is: max. 16 characters (SWIFT-x-red) References for error messages [▶ 1322]: <ul style="list-style-type: none"> <input type="checkbox"/> MVL1873 <input type="checkbox"/> MVL1869 <input type="checkbox"/> MVCP099 This field is also available as a show field for existing records.
Reference Owner	Enter the BIC of the instructing party of the instruction to be linked/unlinked to Required format is: max. 11 characters (SWIFT-x) If the 'Reference Type' is set to any value different than 'T2S reference' this field becomes mandatory. This field is also available as a show field for existing records.

Intra-Balance Movement	
Options	Information on functions (icons) can be found in Common Buttons and Icons [▶ 43].
Pool Instruction Reference	<p>Enter the collective identification identifying a set of messages.</p> <p>Required format is: max. 16 characters (SWIFT-x-red)</p> <p>References for error messages [▶ 1322]:</p> <ul style="list-style-type: none"> <input type="checkbox"/> MVCP018 <input type="checkbox"/> MVLI836 <input type="checkbox"/> MVLI848 <input type="checkbox"/> MVLI868 <input type="checkbox"/> MVLI876
Pool Instruction Counter	<p>Enter the identification of the pool counter.</p> <p>Required format is: Integer</p> <p>References for error messages [▶ 1322]:</p> <ul style="list-style-type: none"> <input type="checkbox"/> MVLI844 <input type="checkbox"/> MVLI846 <p>This field becomes mandatory when the pool instruction reference is filled in.</p>
Pool Reference Owner BIC	<p>Enter the BIC of the owner of the Pool Instruction Reference.</p> <p>The field 'Pool Reference Owner BIC' becomes mandatory when the field 'Pool Instruction Reference' is filled in.</p>

Buttons

Submit	<p>This function enables you to create a new intra-balance movement instruction. Upon clicking on the <i>submit</i> button you will be asked to enter your PIN for digital signature purposes (NRO). With the entry of the PIN, T2S attaches a digital signature to the instruction entered by the T2S actor.</p> <p>Next screen:</p> <ul style="list-style-type: none"> <input type="checkbox"/> <i>Intra-balance movements – search/list</i> screen [▶ 423] <p>References for error messages [▶ 1322]:</p> <ul style="list-style-type: none"> <input type="checkbox"/> MVCA106 <input type="checkbox"/> MVCA508
--------	--

- MVCA512
- MVCP017
- MVCP018
- MVCP045
- MVCP098
- MVCP099
- MVCP120
- MVCU102
- MVCU104
- MVCU108
- MCVV110
- MCVV230
- MCVV255
- MCVV291
- MCVV292
- MVDC003
- MVDC005
- MVDC007
- MVDC015
- MVDC017
- MVDC019
- MVDC022
- MVDC023
- MVDC025
- MVLI805
- MVLI806
- MVLI807
- MVLI819
- MVLI820
- MVLI821
- MVLI822
- MVLI823

- MVLI824
- MVLI834
- MVLI835
- MVLI836
- MVLI844
- MVLI846
- MVLI848
- MVLI852
- MVLI855
- MVLI858
- MVLI861
- MVLI864
- MVLI866
- MVLI868
- MVLI869
- MVLI873
- MVLI876
- MVRR901
- MVRR903
- MVRR905
- MVRR906
- MVRR910
- MVRR916
- MVRR917
- MVRR918
- MVRR924
- MVRR925
- MVRR978
- MVRR989
- MVRR992
- MVRR993
- MVRR994

	<input type="checkbox"/> MVSD404 <input type="checkbox"/> MVSP212 <input type="checkbox"/> MVS705 <input type="checkbox"/> MVS706 <input type="checkbox"/> MVS708
Cancel	<p>This function enables you to cancel the process and return to the previous screen.</p> <p>Next screen:</p> <input type="checkbox"/> <i>Intra-balance movements – search/list</i> screen [▶ 423]
Reset	<p>This function enables you to set all fields to default value and blanks out all optional fields.</p> <p>Next screen:</p> <input type="checkbox"/> <i>Intra-balance movement – new</i> screen

2.3.3.8 Maintenance Cash Instructions - Search/List Screen

Context of Usage

This screen contains a number of search fields. By inputting the relevant data, you can search for maintenance cash instructions. The search results will be displayed in a list. After selecting an entry, you can proceed further by clicking on the buttons below.

This screen is not relevant for CSD users.

Screen Access

Cash >> Settlement >> Maintenance Cash Instructions

Privileges

To use this screen, you need the following privileges [▶ 1218]:

- Maintenance instruction for intra balance movements query
- Cancellation instruction for intra balance movements query
- Amendment instruction query for intra balance movements

References

User Instructions Part

This screen is part of the following business scenarios:

- View amendment instruction for a settlement restriction on cash details [▶ 813]
- View cancellation instruction for a settlement restriction on cash details [▶ 819]

Business Functionality Document

This screen corresponds to the following business function:

- Query instruction (T2S.GUI.SESE.INX.0010)
- Display instruction list (T2S.GUI.SESE.INX.0020)

Screenshot

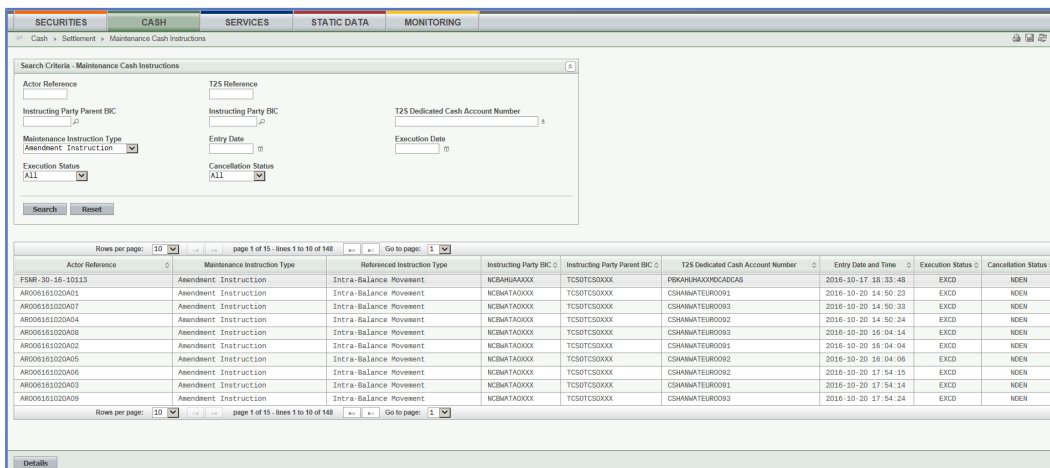

Illustration 92: Maintenance cash instructions - search/list screen

Field Description

Maintenance Cash Instructions – Search Criteria	
Referenced Instruction	
Actor Reference	Enter the reference assigned by the T2S actor to the referenced settlement restriction on cash. Required format is: max. 16 characters (SWIFT-x)
T2S Reference	Enter the identification of the reference assigned to the referenced settlement restriction on cash by T2S. Required format is: max. 16 characters (SWIFT-x)
General Criteria	
Instructing Party BIC	You can choose to either enter the BIC of the instructing party or to select it from the suggested items in the drop-down menu. Required format is: max. 11 characters (SWIFT-x) References for error messages [▶ 1370]: <input type="checkbox"/> QMPC032 <input type="checkbox"/> QMPC084
Instructing Party Parent BIC	You can choose to either enter the parent BIC of the instructing party or to select it from the suggested items in the drop-down menu. Required format is: max. 11 characters (SWIFT-x). References for error messages [▶ 1370]:

Maintenance Cash Instructions – Search Criteria	
	<input type="checkbox"/> QMPC048 <input type="checkbox"/> QMPC084
T2S Dedicated Cash Account Number	Select the dedicated cash account from the drop-down menu. Required format is: max. 34 characters (SWIFT-x)
Maintenance Instruction Type	Select the type of the maintenance instruction from the possible values: <input type="checkbox"/> Cancellation instruction <input type="checkbox"/> Amendment instruction (default value)
Entry Date	Enter the date when the maintenance instruction was created in T2S or use the <i>calendar</i> icon. Required format is: YYYY-MM-DD Reference for error message [▶ 1370]: <input type="checkbox"/> QMPC095
Execution Date	Enter the business date when the maintenance instruction has been executed or use the <i>calendar</i> icon. Required format is: YYYY-MM-DD
Status criteria	
Execution Status	Select the execution status of the maintenance instruction from the possible values: <input type="checkbox"/> All (default value) <input type="checkbox"/> Not executed <input type="checkbox"/> Executed
Cancellation Status	Select the cancellation status of the maintenance instruction from the possible values: <input type="checkbox"/> All (default value) <input type="checkbox"/> Cancelled <input type="checkbox"/> Not cancelled
Maintenance Cash Instructions - List	
Actor Reference	Shows the reference assigned by the T2S actor to the referenced settlement restriction on cash.
Maintenance Instruction Type	Shows the type of maintenance instruction from the possible values: <input type="checkbox"/> Amendment instruction

Maintenance Cash Instructions – Search Criteria	
	<input type="checkbox"/> Cancellation instruction
Referenced Instruction Type	Shows the type of the referenced instruction. The only possible value is 'Intra-Balance Movement'.
Instructing Party BIC	Shows the BIC of the instructing party of the referenced settlement restriction.
Instructing Party Parent BIC	Shows the parent BIC of the instructing party of the referenced settlement restriction.
T2S Dedicated Cash Account Number	Shows the number of the dedicated cash account.
Entry Date and Time	Shows the date and time when the maintenance instruction has been created.
Execution Status	Shows the execution status of the maintenance instruction from the possible values: <input type="checkbox"/> Not Executed <input type="checkbox"/> Executed
Cancellation Status	Shows the cancellation status of the maintenance instruction from the possible values: <input type="checkbox"/> Not denied <input type="checkbox"/> Denied

Buttons

Buttons	
Search	<p>This function enables you to start a search according to the criteria entered. The results are displayed in a list on the next screen.</p> <p>If the search retrieves a single record, the <i>details</i> screen is displayed directly.</p> <p>Next screens:</p> <ul style="list-style-type: none"> <input type="checkbox"/> <i>Maintenance cash instructions – search/list</i> screen <input type="checkbox"/> <i>Amendment cash instruction - details</i> screen [▶ 405] <input type="checkbox"/> <i>Cancellation cash instruction - details</i> screen [▶ 417] <p>References for error messages [▶ 1370]:</p> <ul style="list-style-type: none"> <input type="checkbox"/> QMPC031 <input type="checkbox"/> QMPC032 <input type="checkbox"/> QMPC048 <input type="checkbox"/> QMPC084

	<ul style="list-style-type: none"> <input type="checkbox"/> QMPC095
Reset	<p>This function enables you to set default search criteria and blanks out all optional criteria.</p> <p>Next screen:</p> <ul style="list-style-type: none"> <input type="checkbox"/> <i>Maintenance cash instructions – search/list</i> screen
Details	<p>This function enables you to display the details of the selected maintenance instruction.</p> <p>Next screens:</p> <ul style="list-style-type: none"> <input type="checkbox"/> <i>Amendment cash instruction – details</i> screen [▶ 405] <input type="checkbox"/> <i>Cancellation cash instruction – details</i> screen [▶ 417]

2.3.3.9 Status History - Details Screen

See *Status History – Details* Screen [▶ 267].

2.4 Services

2.4.1 Additional Services

2.4.1.1 Available Reports - Search/List Screen

Context of Usage

This screen contains a number of search fields. By inputting the relevant data, you can search for the latest available reports. The search results will be displayed in a list, which is sorted by the values of the 'Report Type' column in descending order (default setting). After selecting an entry, you can proceed further by clicking on the buttons below.

There is no usage restriction for this screen.

Screen Access

Services >> Additional Services >> Reports

Privileges

To use this screen, you need the following privilege [▶ 1204]:

Report list query

References

User Instructions Part

This screen is part of the following business scenario:

View available reports

Business Functionality Document

This screen corresponds to the following business functions:

- Query generated reports (T2S.GUI.INSE.RPT.0070)
- Display generated reports list (T2S.GUI.INSE.RPT.0080)

Screenshot

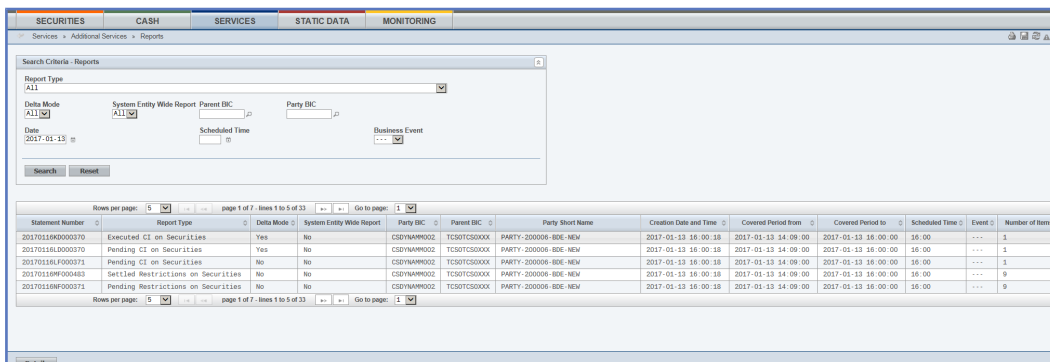

Illustration 93: Available reports - search/list screen

Field Description

Available Reports – Search Criteria	
Report Type	Select the type of report from the possible values: <ul style="list-style-type: none"> <input type="checkbox"/> All <input type="checkbox"/> Statement of holdings <input type="checkbox"/> Statement of transactions <input type="checkbox"/> Statement of pending instructions <input type="checkbox"/> Statement of settlement allegements <input type="checkbox"/> Statement of accounts <input type="checkbox"/> Current settlement day cash information report <input type="checkbox"/> Daily Penalty List <input type="checkbox"/> Following settlement day cash forecast report <input type="checkbox"/> Following settlement day cash forecast report <input type="checkbox"/> List of Modified Penalties <input type="checkbox"/> Monthly Aggregated Amounts <input type="checkbox"/> Statement of executed amendment instructions for intra-balance movements <input type="checkbox"/> Statement of executed amendment instructions for intra-position movements and settlement instructions <input type="checkbox"/> Statement of executed cancellation instructions for intra-balance movements <input type="checkbox"/> Statement of executed cancellation instructions for intra-position movements and settlement instructions <input type="checkbox"/> Statement of pending amendment instructions for intra-balance movements

Available Reports – Search Criteria	
	<ul style="list-style-type: none"> <input type="checkbox"/> Statement of pending amendment instructions for intra-position movements and settlement instructions <input type="checkbox"/> Statement of pending cancellation instructions for intra-balance movements <input type="checkbox"/> Statement of pending cancellation instructions for intra-position movements and settlement instructions <input type="checkbox"/> Statement of pending intra-balance movements <input type="checkbox"/> Statement of pending intra-position movements <input type="checkbox"/> Statement of settled intra-balance movements <input type="checkbox"/> Statement of settled intra-position movements
Delta Mode	<p>Select the mode of the report from the possible values:</p> <ul style="list-style-type: none"> <input type="checkbox"/> Yes <input type="checkbox"/> No <input type="checkbox"/> All (default value)
System Entity Wide Report	<p>Select whether the report is a community report (covering all information referring to a system entity) or a party based report (covering all information referring to a party) from the possible values:</p> <ul style="list-style-type: none"> <input type="checkbox"/> Yes <input type="checkbox"/> No <input type="checkbox"/> All (default value)
Party BIC	<p>Select the BIC of the party.</p> <p>References for error messages [▶ 1284]:</p> <ul style="list-style-type: none"> <input type="checkbox"/> QMPC032 <input type="checkbox"/> QMPC084
Parent BIC	<p>Select the parent BIC of the party whose data are reported.</p> <p>References for error messages [▶ 1284]:</p> <ul style="list-style-type: none"> <input type="checkbox"/> QMPC048 <input type="checkbox"/> QMPC084
Date	<p>Enter the creation date of the report or use the <i>calendar</i> icon.</p> <p>Required format is: YYYY-MM-DD</p> <p>Reference for error message [▶ 1284]:</p>

Available Reports – Search Criteria	
	<input type="checkbox"/> QMPC055
Scheduled Time	Enter the scheduled time of the (business) event triggering the report creation. Required format is: hh:mm If this field is filled, the ‘Business Event’ field must not be filled and vice versa.
Business Event	Select the business event. If this field is filled, the ‘Scheduled Time’ field must not be filled and vice versa.
Available Reports - List	
Statement Number	Shows the statement number of the report composed of the business date and report type (2-letter abbreviation depending on report type and Delta/Full-Flag) and the sequential number, which is unique in T2S. The number increases for each report.
Report Type	Shows the report type.
Delta Mode	Shows if the report is a delta report or not. Possible values are: <input type="checkbox"/> Yes <input type="checkbox"/> No
System Entity Wide Reports	Shows whether the report is a community report (covering all information referring to a system entity) or a party based report (covering all information referring to a party).
Party BIC	Shows the BIC of the data owning party.
Parent BIC	Shows the parent BIC of the party whose data are reported.
Party Short Name	Shows the short name of the party.
Creation Date and Time	Shows the date and time of the report creation. Displayed format is: YYYY-MM-DD hh:mm:ss
Covered Period from	Shows the date and time from which the data are covered in the report. Displayed format is: YYYY-MM-DD hh:mm:ss
Covered Period to	Shows the date and time until which the data are covered in the report. Displayed format is: YYYY-MM-DD hh:mm:ss

Available Reports – Search Criteria	
Scheduled Time	Shows the scheduled time which triggering the report creation.
Event	Shows the configured business event which triggered the creation of the report.
Number of Items	Shows the number of business items which are reported with this report.

Buttons

Buttons	
Search	<p>This function enables you to start a search according to the criteria entered. The results are displayed in a list on the same screen.</p> <p>If the search retrieves a single record, the <i>details</i> screen is displayed directly.</p> <p>Next screens:</p> <ul style="list-style-type: none"> <input type="checkbox"/> <i>Available reports – search/list</i> screen <input type="checkbox"/> <i>Available report – details</i> screen [▶ 457] <p>References for error messages [▶ 1284]:</p> <ul style="list-style-type: none"> <input type="checkbox"/> QMPC032 <input type="checkbox"/> QMPC048 <input type="checkbox"/> QMPC055 <input type="checkbox"/> QMPC084
Reset	<p>This function enables you to set default search criteria and blanks out all optional criteria.</p> <p>Next screen:</p> <ul style="list-style-type: none"> <input type="checkbox"/> <i>Available reports – search/list</i> screen
Details	<p>This function enables you to display the details of the selected report.</p> <p>Next screens:</p> <ul style="list-style-type: none"> <input type="checkbox"/> <i>Available report – [report type] details</i> screen [▶ 457] (In case the selected report consists of only 1 business item) <input type="checkbox"/> <i>Available report – details</i> screen [▶ 457] (In case the selected report consists of more than 1 business item)

2.4.1.2 Available Report - Details Screen

Context of Usage

This screen displays detailed information on created reports. You can check the data and proceed further by clicking on the button below.

There is no usage restriction for this screen.

Screen Access

Services >> Additional Services >> Reports >> Available reports – search/list screen >> Click on the search and/or details button

Privileges

To use this screen, you need the following privileges [[▶ 1198](#)]:

- Report list query
- Report details query

References

User Instructions Part

This screen is part of the following business scenario:

- View available reports

Business Functionality Document

This screen corresponds to the following business function:

- Display generated reports list (T2S.GUI.INSE.RPT.0080)
- Generated reports query (T2S.GUI.INSE.RPT.0070)

Screenshot

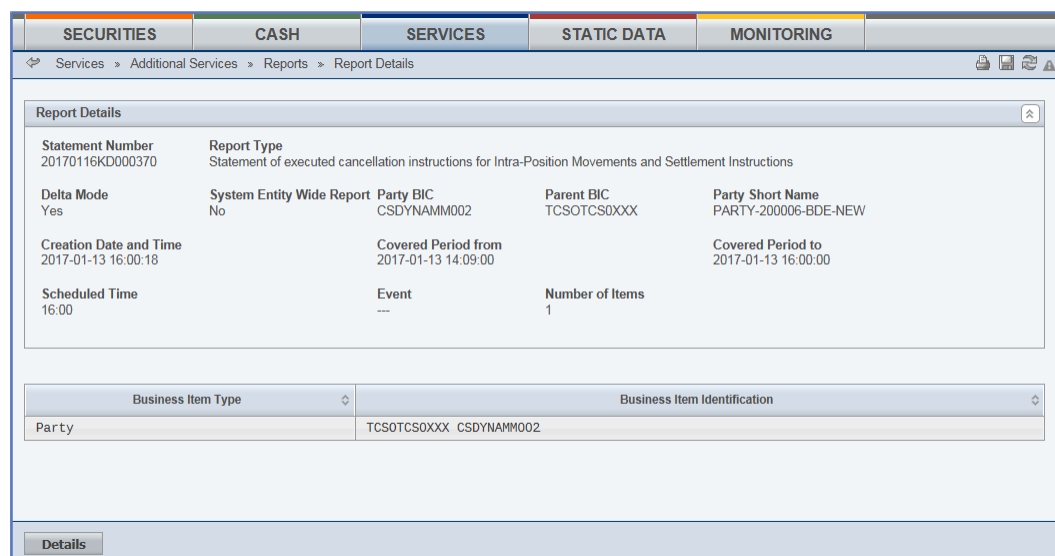

Illustration 94: Available report - details screen

Field Description

Report Information	
Statement Number	Shows the statement number of the report composed of the business date and report type (2-letter-abbreviation depending on report type and delta/full-flag) and the sequential number, which is unique in T2S. The number increases for each report.
Report Type	Shows the type of the report.

Report Information	
	There is a predefined set of report types which are described in the published documents, e.g. statement of holdings.
Delta Mode	Shows if the report is a delta report or not. Possible values are: <input type="checkbox"/> Yes <input type="checkbox"/> No
System Entity Wide Report	Shows whether the report is a community report (covering all information referring to a party) or a party based report (covering all information to a party) from the possible values: <input type="checkbox"/> Yes <input type="checkbox"/> No
Party BIC	Shows the BIC of the data owning party.
Parent BIC	Shows the parent BIC of the party whose data are reported.
Party Short Name	Shows the short name of the party.
Creation Date and Time	Shows the date and time of the report creation. Displayed format is: YYYY-MM-DD hh:mm:ss
Covered Period from	Shows the date and time from which the data are covered in the report. Displayed format is: YYYY-MM-DD hh:mm:ss
Covered Period to	Shows the date and time until which the data are covered in the report. Displayed format is: YYYY-MM-DD hh:mm:ss
Scheduled Time	Shows the scheduled time which triggered the report creation. Displayed format is: hh:mm
Event	Shows the configured business event which triggered the creation of the report.
Number of Items	Shows the number of business items which are reported with this report.
Reported Business Item - List	
Business Item Type	Shows the information on the type of the report message segregating entity.

Report Information	
Business Item Identification	Shows the business identifier of the reported business item (T2S Dedicated Cash Account Number, Securities Account Number, Currency Code or Party BIC).
Button	
Details	This function enables you to display the single business item of the selected report. Next screen: <input type="checkbox"/> <i>Available report – [Report Type] – details</i> screen

2.4.1.3 Available Report - Current Settlement Day Cash Information (Following Settlement Day Cash Forecast) Report - Details Screen

Context of Usage

This screen displays detailed information on the current settlement day cash information report (or on the selected settlement day cash information report for the following settlement day). These reports are similar and therefore described together.

The report projects the liquidity position at the end-of-day under consideration of settlement instructions, liquidity transfer orders and the calculated amount of outstanding credits in the system, at the moment of the report creation, which are valid for the current (or the following) business day.

The report displayed in this screen has to be already created in accordance with its report configuration.

This screen is not relevant for CSD, external CSD and CSD participant users.

Screen Access

- Services >> Additional Services >> Reports >> Available reports – search/list* screen >> Click on the *details* button
- Services >> Additional Services >> Reports >> Available reports – search/list* screen >> Click on the *search* and/or *details* button >> *Available report – details* screen >> Click on the *details* button

Privileges

To use this screen, you need the following privilege [ 1198]:

- Report details query

References

User Instructions Part

This screen is part of the following business scenario:

- View available reports

Business Functionality Document

This screen corresponds to the following business function:

Display generated report details (T2S.GUI.INSE.RPT.0090)

Screenshot

Illustration 95: Available report - current settlement day cash information - details screen

Field Description

General Information	
Report Name	Shows the name of the report.
Delta Mode	Shows the delta mode of the report, which is always 'No'.

General Information	
Statement Number	Shows the statement number of the report composed of the business date and report type (2-letter abbreviation depending on report type and delta/full-Flag) and the sequential number, which is unique in T2S. The number increases for each report.
Report Number	Shows the sequential number of the report which is specific for a report receiving party. This number will only be displayed if the sending user belongs to a report receiving party.
Scheduled	Shows the name of the business event or time triggering the report creation.
Covered Period from	Shows the date and time from which the data are covered in the report. Displayed format is: YYYY-MM-DD hh:mm:ss
Covered Period to	Shows the date and time until which the data are covered in the report. Displayed format is: YYYY-MM-DD hh:mm:ss
Report Owner BIC	Shows the BIC of the party whose data is reported on.
Report Owner Parent BIC	Shows the parent BIC of the party whose data is reported on.
System Entity Wide Report	Shows whether the report is a community report (covering all information referring to a system entity) or a party based report (covering all information referring to a party) from the possible values: <input type="checkbox"/> Yes <input type="checkbox"/> No
Forecast Date	Shows the date of the current (or following) settlement day. Displayed format is: YYYY-MM-DD
Statement	
Repetitive Block For Each Reported Dedicated Cash Account	
T2S Dedicated Cash Account Number	Shows the dedicated cash account number for which the report is created.
Currency	Shows the currency code.
T2S Dedicated Cash Account Owner BIC	Shows the BIC of the party owning the T2S dedicated cash account.

General Information	
T2S Dedicated Cash Account Owner Name	Shows the name of the party that owns the dedicated cash account.
T2S Dedicated Cash Account Servicer BIC	Shows the BIC of the party operating the T2S dedicated cash account.
Balance	
Repetitive Block For Each Reported Dedicated Cash Account	
Balance Type	Shows the type of the balance from the possible values: <ul style="list-style-type: none"> <input type="checkbox"/> Actual cash balance ('Sum of cash balance on the T2S dedicated cash account') <input type="checkbox"/> Sum of Actual cash balance and pending liquidity transfers and settlement instructions eligible for cash forecast ('Projected sum of cash balance, liquidity transfer orders and settlement instructions') <input type="checkbox"/> Outstanding intraday credit from auto-collateralisation <input type="checkbox"/> Projected balance ¹⁷, i.e. Sum of cash balance and pending LTs and SI and Amount of Outstanding intraday credit from auto-collateralisation ('Sum projected cash balance')
Forecast Date	Shows the current date or the date of the next settlement day. Displayed format is: YYYY-MM-DD
Debit Credit Indicator	Shows if an operation is a credit or a debit from the possible values: <ul style="list-style-type: none"> <input type="checkbox"/> + (for 'Credit') <input type="checkbox"/> - (for 'Debit')
Balance	Shows the balance of the dedicated cash account. There will be always one cash balance per balance type.
Expected Postings	
Repetitive Block For Each Reported Dedicated Cash Account	

17 In UHB and T2S GUI, "projected balance" means the sum of cash balance and pending LTs and SIs and outstanding intraday credit from auto-collateralisation. In T2S UDFS and MyStandards, "projected balance" means the sum of cash balance and pending LTs and SIs (outstanding intraday credit from auto-collateralisation is not part of the calculation, i.e. is not subtracted).

General Information	
Posting Type	<p>Shows the type of posting to be settled until end of day (or to be effective for the forecast day) from the possible values:</p> <ul style="list-style-type: none"> <input type="checkbox"/> Debiting valid and eligible settlement instructions (i.e. matched and ready for settlement) <input type="checkbox"/> Debiting Settlement instructions, thereof non CORP released <input type="checkbox"/> Debiting Settlement instructions, thereof non CORP on hold <input type="checkbox"/> Debiting Settlement instructions, thereof CORP released <input type="checkbox"/> Debiting Settlement instructions, thereof CORP on hold <input type="checkbox"/> Crediting valid and eligible settlement instructions (i.e. matched and ready for settlement) <input type="checkbox"/> Crediting Settlement instructions, thereof non CORP released <input type="checkbox"/> Crediting Settlement instructions, thereof non CORP on hold <input type="checkbox"/> Crediting Settlement instructions, thereof CORP released <input type="checkbox"/> Crediting Settlement instructions, thereof CORP on hold <input type="checkbox"/> Debiting liquidity transfer orders
Number of Expected Postings	Shows the number of expected postings.
Debit Credit Indicator	<p>Shows if an operation is a credit or a debit from the possible values:</p> <ul style="list-style-type: none"> <input type="checkbox"/> + (for 'Credit') <input type="checkbox"/> - (for 'Debit')
Expected postings	Shows the total amount (including currency) expected for all postings of the same posting type, to be settled until end of day.

2.4.1.4 Available Report - Statement of Accounts - Details Screen

Context of Usage

This screen displays detailed information on the selected statement of accounts. No new report will be created by entering this screen. The report will be displayed in a new window. The report displayed in this screen has to be already created in accordance with its report configuration.

For large reports the user has the option to view them in portions of up to 500 transactions. Only the current portion of the report will be available for a download or print.

This screen is not relevant for CSD, external CSD and CSD participant users.

Screen Access

- Services >> Additional Services >> Reports >> *Available reports – search/list* screen >> Click on the *details* button
- Services >> Additional Services >> Reports >> *Available reports – search/list* screen >> Click on the *search* and/or *details* button >> *Available report – details* screen >> Click on the *details* button

Privileges

To use this screen, you need the following privilege [**▶ 1199**]:

- Report details query

References

User Instructions Part

This screen is part of the following business scenario:

- View available reports

Business Functionality Document

This screen corresponds to the following business function:

- Display generated report details (T2S.GUI.INSE.RPT.0090)

Screenshot

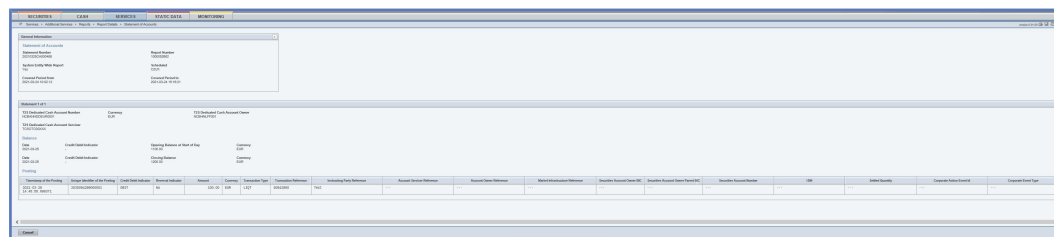

Illustration 96: Available report – statement of accounts – details screen

Field Description

General Statement Information	
Statement of Accounts	
Report Name	Shows the name of the report.
Delta Mode	Shows the delta mode of the report, which is always 'No'.

General Statement Information	
Statement Number	Shows the statement number of the report composed of the business date and report type (2-letter abbreviation depending on report type and Delta/Full-Flag) and the sequential number, which is unique in T2S. The number increases for each report.
Report Number	Shows the sequential number of the report which is specific for a report receiving party. This number will only be displayed if the sending user belongs to a report receiving party.
Scheduled	Shows the name of the business event or time triggering the report creation.
Covered Period from	Shows the date and time from which the data are covered in the report. Displayed format is: YYYY-MM-DD hh:mm:ss
Covered Period to	Shows the date and time until which the data are covered in the report. Displayed format is: YYYY-MM-DD hh:mm:ss
Report Owner BIC	Shows the BIC of the statement of accounts owning party.
Report Owner Parent BIC	Shows the parent BIC of the party whose statement of accounts is reported.
System Entity Wide Report	Shows whether the report is a community report (covering all information referring to a system entity) or a party based report (covering all information referring to a party) possible values: <input type="checkbox"/> True <input type="checkbox"/> False
Statement	
Repetitive Block For Each Reported Dedicated Cash Account	
T2S Dedicated Cash Account Number	Shows the T2S dedicated cash account number for which the report is created.
Currency	Shows the currency code.
T2S Cash Account Owner BIC	Shows the BIC of the party that owns the T2S dedicated cash account.
T2S Cash Account Servicer BIC	Shows the BIC of the party that operates the T2S dedicated cash account.
Balance	

General Statement Information	
Repetitive Block For Each Balance Type (Opening/ Closing) Within Every Statement Block	
Date	Shows the date of the balance. Displayed format is: YYYY-MM-DD
Debit Credit Indicator	Shows if an operation is a credit or a debit from the possible values: <input type="checkbox"/> + (for 'Credit') <input type="checkbox"/> - (for 'Debit')
Opening Balance at Start of Day/Closing Balance	Shows the balance of the T2S dedicated cash account.
Currency	Shows the currency code.
Postings	
Repetitive Block For Each Reported Dedicated Cash Account	
Date and Time of the Posting	Shows the date and the time when a booking took place. Displayed format is: YYYY-MM-DD hh:mm:ss
Posting Identifier	Shows the unique identification of a posting in T2S.
Debit Credit Indicator	Shows if an operation is a credit or a debit from the possible values: <input type="checkbox"/> + (for 'Credit') <input type="checkbox"/> - (for 'Debit')
Reversal Indicator	Indicates whether or not the entry is the result of a reversal. ¹⁸
Amount	Shows the amount of money.
Currency	Shows the currency code.
Transaction Type	Shows the proprietary bank transaction code related to the underlying transaction type.
Instructing Party Reference	Shows the unique identification assigned by the instructing party of the underlying transaction.
Transaction Reference	Shows the unique identification assigned by the underlying clearing system.
Account Servicer Reference	Shows the account servicer reference of the settlement instruction.

18 Please note that the described functionality won't be available before CSLD go-live.

General Statement Information	
	This field is only filled in, if the underlying instruction is a settlement instruction.
Account Owner Reference	Shows the account owner reference of the settlement instruction. This field is only filled in, if the underlying instruction is a settlement instruction.
Market Infrastructure Reference	Shows the identification of the settlement instruction as assigned by the T2S. This field is only filled in, if the underlying instruction is a settlement instruction.
Securities Account Owner BIC	Shows the BIC of the party owning the securities account. This field is only filled in, if the underlying instruction is a settlement instruction.
Securities Account Owner Parent BIC	Shows the parent BIC of the T2S party owning the securities account. This field is only filled in, if the underlying instruction is a settlement instruction.
Securities Account Number	Shows the number of the securities account to which the Dedicated Cash Account that this report refers to is linked and which was booked with the respective securities quantity
ISIN	Shows the ISIN of the security booked
Settled Quantity	Shows the quantity of securities that settled with this booking
Corporate Action Event Id	Shows the Corporate Action Event Id in case the Settlement Instruction is belonging to a Corporate Action
Corporate Action Event Type	Shows the value "OTHR", in case the Corporate Action Event Id is filled

2.4.1.5 Available Report - Statement of Executed Amendment Instructions for Intra-Balance Movements - Details Screen

Context of Usage

This screen displays detailed information on the selected statement of executed amendment instructions for intra-balance movements. The report in this screen has to be already created in accordance with its report configuration.

This screen is not relevant for CSD, external CSD and CSD participant users.

- Screen Access**
- Services >> Additional Services >> Reports >> *Available reports – search/list* screen >> Click on the *details* button
 - Services >> Additional Services >> Reports >> *Available reports – search/list* screen >> Click on the *details* button >> *Available report – details* screen >> Click on the *details* button

Privileges To use this screen you need the following privilege [▶ 1199]:

- Report details query

References **User Instructions Part**

This screen is part of the following business scenario:

- View available reports

Business Functionality Document

This screen corresponds to the following business function:

- Display generated report details (T2S.GUI.INSE.RPT.0090)

Screenshot

General Information	
General Statement Information	
Report Statement of executed amendment instructions for Intra-Balance Movements	Delta Mode Yes
Statement Number 20170116ID000171	Report Number 1000003862
Frequency DAIL	Scheduled 16:00
Activity Indicator False	
Covered Period from 2017-01-13 14:09:00	Covered Period to 2017-01-13 16:00:00
Report Owner BIC NCBKDEFFQ01	Report Owner Parent BIC TCSOTCS0XXX
System Entity Wide Report No	

Illustration 97: Available report - statement of executed amendment instructions for intra-balance movements - details screen

Field Description

General Statement Information	
Report Name	Shows the name of the report
Delta Mode	Shows if the report is a delta report or not. Possible values are: <ul style="list-style-type: none"> <input type="checkbox"/> Yes <input type="checkbox"/> No

General Statement Information	
Statement Number	Shows the statement number of the report composed of the business date and report type (2-letter abbreviation depending on report type and delta/full-flag) and the sequential number, which is unique in T2S. The number increases for each report.
Report Number	Shows the sequential number of the report which is specific for a report receiving party. This number will only be displayed if the sending user belongs to a report receiving party.
Frequency	Shows the frequency of the report, which is always 'DAILY'.
Scheduled	Shows the name of the business event or time triggering the report creation.
Activity Indicator	Shows whether the report displays activities or only lists information from the possible values: <input type="checkbox"/> True <input type="checkbox"/> False
Covered Period from	Shows the date and time from which the data are covered in the report. Displayed format is: YYYY-MM-DD hh:mm:ss
Covered Period to	Shows the date and time until which the data are covered in the report. Displayed format is: YYYY-MM-DD hh:mm:ss
Report Owner BIC	Shows the BIC of the party whose data are reported.
Report Owner Parent BIC	Shows the parent BIC of the party whose data are reported.
System Entity Wide Report	Shows whether the report is a community report (covering all information referring to a system entity) or a party based report (covering all information referring to a party) from the possible values: <input type="checkbox"/> Yes <input type="checkbox"/> No
T2S Dedicated Cash Account Information	
T2S Dedicated Cash Account Number	Shows the T2S dedicated cash account number for which the report is created.

General Statement Information	
T2S Dedicated Cash Account Owner BIC	Shows the BIC of the party owning the T2S dedicated cash account.
T2S Dedicated Cash Account Servicer BIC	Shows the BIC of the party operating the T2S dedicated cash account.
Processing Status of the Amendment Instruction	
Repetitive Block For Each Amendment Instruction Of The Available Report	
Last Update of Status	Shows the date and time of the last status update. Displayed format is: YYYY-MM-DD hh:mm:ss:μsμsμsμsμs
Cancellation Status	Shows the status of the amendment instruction from the possible values: <input type="checkbox"/> Canc (for 'Cancelled') <input type="checkbox"/> Ncan (for 'Not Cancelled')
Execution Status	Shows the execution status of the amendment instruction from the possible values: <input type="checkbox"/> Excd (for 'Executed') <input type="checkbox"/> Nexd (for 'Not Executed')
Cancellation Status Reason Code	Shows the reason code for the cancellation.
Cancellation Status Additional Information	Shows additional information on the cancellation status.
Modification Information	
Actor Reference	Shows the identification of the instruction assigned by the T2S actor.
References assigned to the settlement restriction on the Cash Balance	
Account Owner Reference	Shows the identification of the instruction assigned by the account owner.
Account Servicer Reference	Shows the identification of the instruction assigned by the account servicer.
Amendment Instruction Technical Identifier	Shows the technical identification of the amendment instruction as assigned by T2S.
Third Party Reference	Shows the identification of the instruction assigned by a third party.

General Statement Information	
Linkage Type of Instruction	Shows the linkage type of the instruction from the possible values: <input type="checkbox"/> Link (for 'Linked') <input type="checkbox"/> Unlk (for 'Unlinked')
Priority	Shows the priority of the payment instruction assigned by the originator of the instruction from the possible values: <input type="checkbox"/> Normal <input type="checkbox"/> High <input type="checkbox"/> Top <input type="checkbox"/> Reserved
Further information on underlying settlement restriction	
Repetitive Block For Each Linked Instruction	
Settlement Amount	Shows the settlement amount which is restricted in the settlement restriction instruction.
Intended Settlement Date	Shows the date when the instruction is forwarded to settlement for the first time. Displayed format is: YYYY-MM-DD
Restriction Type Balance from	Shows the code to identify the restriction type balance from.
Restriction Type Balance to	Shows the code to identify the restriction type balance to.
Restriction Reference	Shows the identification of the restriction assigned by T2S.
Priority	Shows the priority of the payment instruction assigned by the originator of the instruction from the possible values: <input type="checkbox"/> Normal <input type="checkbox"/> High <input type="checkbox"/> Top <input type="checkbox"/> Reserved
Link Information	
Repetitive Block For Each Amendment Instruction Of The Available Report	
Link Type	Shows the link type of the instruction from the possible values:

General Statement Information	
	<input type="checkbox"/> Afte (for instruction has to be settled after or at the same time as the linked instruction) <input type="checkbox"/> Befo (for instruction has to be settled before or at the same time as the linked instruction) <input type="checkbox"/> With (for instruction has to be settled at the same time as the linked instruction) <input type="checkbox"/> Info (for specifies that the instructions are linked for information purposes only)
Actor Reference	Shows the identification of the instruction assigned by the T2S actor.
Instructing Party BIC	Shows the BIC of the instructing party.
Linked Instruction T2S Technical Identifier	Shows the technical identification of the linked instruction.
Message Number	Shows the message number.

2.4.1.6 Available Report - Statement of Executed Amendment Instructions for Intra-Position Movements and Settlement Instructions - Details Screen

Context of Usage

This screen displays detailed information on the selected statements of executed amendment instructions for intra-position movements and settlement instructions. The screen opens in a separate window.

This screen is not relevant for CB and payment bank users.

Screen Access

- Services >> Additional Services >> Reports >> *Available reports – search/list* screen >> Click on the *details* button
- Services >> Additional Services >> Reports >> *Available reports – search/list* screen >> Click on the *details* button >> *Available report – details* screen >> Click on the *details* button

Privileges

To use this screen, you need the following privilege [[▶ 1199](#)]:

- Report details query

References

User Instructions Part

This screen is part of the following business scenario:

- View available reports

Business Functionality Document

This screen corresponds to the following business function:

- Display generated report details (T2S.GUI.INSE.RPT.0090)

Screenshot

Illustration 98: Available report - statement of executed amendment instruction for intra-position movements and settlement instructions – details screen

Field Description

General Statement Information	
Report Name	Shows the name of the report.
Delta Mode	Shows if the report is a delta report or not. Possible values are: <input type="checkbox"/> Yes <input type="checkbox"/> No
Statement Number	Shows the statement number of the report composed of the business date and report type (2-letter abbreviation depending on report type and delta/full-flag) and the sequential number, which is unique in T2S. The number increases for each report.
Report Number	Shows the sequential number of the report which is specific for a report receiving party. This number will only be displayed if the sending user belongs to a report receiving party.
Scheduled	Shows the business event or time or time triggering the report creation.
Frequency	Shows the frequency of the report, which is always 'DAILY'.
Activity Indicator	Shows whether the report displays activities or only lists information from the possible values:

General Statement Information	
	<input type="checkbox"/> True <input type="checkbox"/> False
Covered Period from	Shows the date and time from which the data are covered in the report. Displayed format is: YYYY-MM-DD hh:mm:ss
Covered Period to	Shows the date and time until which the data are covered in the report. Displayed format is: YYYY-MM-DD hh:mm:ss
Report Owner BIC	Shows the BIC of the party whose data are reported.
Report Owner Parent BIC	Shows the parent BIC of the party whose data are reported.
System Entity Wide Report	Shows whether the report is a community report (covering all information referring to a system entity) or a party based report (covering all information referring to a party). from the possible values: <input type="checkbox"/> Yes <input type="checkbox"/> No
Amendment Instruction or Hold/Release Instruction Repetitive block for each amendment or hold/release instruction	
Securities Account Information	
Securities Account Number	Shows the number of the securities account.
Securities Account Owner BIC	Shows the BIC of the party owning the securities account.
Securities Account Owner Parent BIC	Shows the parent BIC of the party owning the securities account.
Status Information	
Execution Status	Shows the execution status of the instruction from the possible values: <input type="checkbox"/> EXCD (for executed) <input type="checkbox"/> NEXD (for not executed)
Cancellation Status	Shows the instruction status of the instruction from the possible values: <input type="checkbox"/> DEND (denied) <input type="checkbox"/> NDEN (not denied)

General Statement Information	
Last update of Status	Shows the date and time of the last status update. Displayed format is: YYYY-MM-DD hh:mm:ss
Instruction Information for Hold/Release Instruction	
This subframe is optional and only available for hold/release instructions	
Inbound Individual Message Identification	Shows the technical identification number of the inbound individual message.
Hold/Release Instruction Technical Identifier	Shows the technical identification number of the hold/release instruction.
Hold Status Type	Shows the type of hold status of the instruction from the possible values: <ul style="list-style-type: none"> <input type="checkbox"/> CoSD hold <input type="checkbox"/> CSD hold <input type="checkbox"/> CSD validation hold <input type="checkbox"/> Party hold
On Hold Indicator	Shows whether the instruction is on hold or not from the possible values: <ul style="list-style-type: none"> <input type="checkbox"/> Yes <input type="checkbox"/> No
CoSD Rule Identification	Shows the identification of the respective CoSD rule.
Instruction Information for amendment instructions	
This subframe is optional and only available for amendment instructions	
Amendment Instruction Technical Identifier	Shows the unique identification of the amendment instruction assigned by T2S.
Priority	Shows the priority of the payment instruction assigned by the originator of the instruction from the possible values: <ul style="list-style-type: none"> <input type="checkbox"/> High <input type="checkbox"/> Normal <input type="checkbox"/> Reserved <input type="checkbox"/> Top
Partial Settlement Indicator	Shows if the settlement instruction is allowed to be subject to partial settlement from the possible values:

General Statement Information	
	<input type="checkbox"/> NPAR (for no partial settlement allowed) <input type="checkbox"/> PART (for partial settlement allowed without restrictions) <input type="checkbox"/> PARC (for partial settlement allowed but the settlement amount must not be below the threshold) <input type="checkbox"/> PARQ (for partial settlement allowed but the quantity must not be below the threshold)
Instruction Information for amendment instructions - Linkage Information	
This subframe is optional and only available for amendment instructions	
Linkage Type of Instruction	Shows the linkage type of the instruction from the possible values: <input type="checkbox"/> LINK (for linked) <input type="checkbox"/> UNLK (for unlinked)
Instruction Information for amendment instructions - Linkage Information – Instruction Link	
This subframe is optional and only available for amendment instructions	
Link Type	Shows the link type of the instruction from the possible values: <input type="checkbox"/> AFTE (Instruction has to be settled after or at the same time as the linked instruction) <input type="checkbox"/> BEFO (Instruction has to be settled before or at the same time as the linked instruction) <input type="checkbox"/> WITH (Instruction has to be settled at the same time as the linked instruction)
Linked Instruction T2S Technical Identifier	Shows the identification of the linked instruction assigned by T2S.
Linked Instruction Reference of Party	Shows the T2S actor reference of the LCMM instruction with which the relevant LCMM instruction is linked. If there is more than one link between LCMM instructions, the settlement link indicator is shown.
Received Account Owner BIC	Shows the BIC of the party who owns the identification of the instruction/pool to which this instruction is linked.
System Entity Reference Owner	Shows the identification of the system entity of the T2S party owner.

General Statement Information	
Message Number	Shows the identification of the message referenced in the linkage sequence.
Pool Instruction Reference	Shows the identification of the pool groups.
To be modified instruction	
Intra-Position Movement Information	
This subframe is optional and only available for intra-position movement information	
ISIN	Shows the ISIN of the security.
Original Settlement Quantity	Shows the quantity of securities to be settled.
Settlement Type	Shows the type of settlement from the possible values: <input type="checkbox"/> UNIT <input type="checkbox"/> FAMT
Intended Settlement Date	Shows the date when the instruction is forwarded to settlement for the first time. Displayed format is: YYYY-MM-DD
Restriction Type Balance from	Shows the restriction type code of a balance of a T2S dedicated cash account/position of a securities account which is debited.
Restriction Type Balance to	Shows a restriction type code of a balance of a T2S dedicated cash account/position of a securities account which is credited.
Restriction Reference	Shows the identification of the restriction assigned by T2S.
Priority	Shows the priority of the payment instruction assigned by the originator of the instruction from the possible values: <input type="checkbox"/> High <input type="checkbox"/> Normal <input type="checkbox"/> Reserved <input type="checkbox"/> Top
Intra-Position Movement Technical Identifier	Shows the unique technical identification of the intra-position movement assigned by T2S.

General Statement Information	
Account Owner Reference	Shows the identification of the instruction assigned by the delivering/receiving party.
Account Servicer Reference	Shows the identification of the transaction assigned by the CSD.
Third Party Reference	Shows the identification of the instruction assigned by a third party.
Settlement Instruction Information	
This subframe is optional and only available for settlement instruction information	
Settlement Instruction Technical Identifier	Shows the unique identification of the settlement instruction assigned by T2S.
Account Owner Reference	Shows the identification of the settlement instruction assigned by the delivering/receiving party.
Account Servicer Reference	Shows the identification of the settlement instruction assigned by the account servicer.
Third Party Reference	Shows the identification of the settlement instruction assigned by the third party.
ISIN	Shows the ISIN of the security.
Original Settlement Quantity	Shows the quantity of securities to be settled.
Settlement Type	Shows the type of settlement from the possible values: <input type="checkbox"/> UNIT (Units) <input type="checkbox"/> FAMT (Face amount)
Original Settlement Amount	Shows the amount as stated in the settlement instruction.
Settlement Currency	Shows the unique code of the currency.
Debit Credit Indicator	Shows if an operation is a credit or a debit from the possible values: <input type="checkbox"/> CRDT (for credit) <input type="checkbox"/> DBIT (for debit)
Intended Settlement Date	Shows the date when the instruction is forwarded to settlement for the first time. Displayed format is: YYYY-MM-DD
Trade Date	Shows the date when the contract was made.

General Statement Information	
	Displayed format is: YYYY-MM-DD
Delivering Settlement Parties	
This subframe is optional and only available for settlement instruction information	
Delivering Depository	
Party BIC	Shows the BIC of the delivering depository.
Delivering CSD Participant	
Party BIC	Shows the BIC of the CSD participant delivering the securities.
Processing Identification	Shows the unambiguous identification of the transaction as assigned by the delivering party.
Settlement Instruction Information – Settlement Parties – Delivering Settlement Parties – Client of the Delivering CSD Participant	
Specifying the party only via party BIC or its name or the triplet of identification, issuer and scheme name.	
Party BIC	Shows the BIC of the client of delivering CSD participant.
Identification	Shows the proprietary identification of the pre-mentioned party BIC.
Issuer	Shows the entity assigning the identification.
Scheme Name	Shows the name of the scheme.
Name	Shows the name of the client of delivering CSD participant.
Delivering Party 3	
Specifying the party only via party BIC or its name or the triplet of identification, issuer and scheme name.	
Party BIC	Shows the BIC of 'Delivering Party 3'.
Identification	Shows the proprietary identification of the pre-mentioned party BIC.
Issuer	Shows the entity assigning the identification.
Scheme Name	Shows the name of the scheme.
Name	Shows the name of 'Delivering Party 3'.
Delivering Party 4	
Specifying the party only via party BIC or its name or the triplet of identification, issuer and scheme name.	
Party BIC	Shows the BIC of 'Delivering Party 4'.

General Statement Information	
Identification	Shows the proprietary identification of the pre-mentioned party BIC.
Issuer	Shows the entity assigning the identification.
Scheme Name	Shows the name of the scheme.
Name	Shows the name of 'Delivering Party 4'.
Delivering Party 5	
Specifying the party only via party BIC or its name or the triplet of identification, issuer and scheme name.	
Party BIC	Shows the BIC of 'Delivering Party 5'.
Identification	Shows the proprietary identification of the pre-mentioned party BIC.
Issuer	Shows the entity assigning the identification. The fixed value is 'T2S'.
Scheme Name	Shows the name of the scheme.
Name	Shows the name of 'Delivering Party 5'.
Receiving Settlement Parties	
This subframe is optional and only available for settlement instruction information	
Receiving Depository	
Party BIC	Shows the BIC of the receiving depository.
Settlement Instruction Information – Settlement Parties – Receiving Settlement Parties – Receiving CSD Participant	
Party BIC	Shows the BIC of the CSD receiving the securities.
Processing Identification	Shows the unambiguous identification of the transaction as assigned by the receiving party.
Client of the Receiving CSD Participant	
Specifying the party only via party BIC or its name or the triplet of identification, issuer and scheme name.	
Party BIC	Shows the BIC of the client of receiving CSD participant.
Identification	Shows the proprietary identification of the pre-mentioned party BIC.
Issuer	Shows the entity assigning the identification.
Scheme Name	Shows the name of the scheme.
Name	Shows the name of the client of receiving CSD participant.

General Statement Information	
Receiving Party 3	
Specifying the party only via party BIC or its name or the triplet of identification, issuer and scheme name.	
Party BIC	Shows the BIC of Receiving Party 3'.
Identification	Shows the proprietary identification of the pre-mentioned party BIC.
Issuer	Shows the entity assigning the identification.
Scheme Name	Shows the name of the scheme.
Name	Shows the name of Receiving Party 3'.
Receiving Party 4	
Specifying the party only via party BIC or its name or the triplet of identification, issuer and scheme name.	
Party BIC	Shows the BIC of 'Receiving Party 4'.
Identification	Shows the proprietary identification of the pre-mentioned party BIC.
Issuer	Shows the entity assigning the identification.
Scheme Name	Shows the name of the scheme.
Name	Shows the name of 'Receiving Party 4'.
Receiving Party 5	
Specifying the party only via party BIC or its name or the triplet of identification, issuer and scheme name.	
Party BIC	Shows the BIC of 'Receiving Party 5'.
Identification	Shows the proprietary identification of the pre-mentioned party BIC.
Issuer	Shows the entity assigning the identification.
Scheme Name	Shows the name of the scheme.
Name	Shows the name of 'Receiving Party 5'.

2.4.1.7 Available Report - Statement of Executed Cancellation Instructions for Intra-Balance Movements - Details Screen

Context of Usage

This screen displays detailed information on the selected executed cancellation instruction for intra-balance movements.

The report displayed in this screen has to be already created in accordance with its report configuration.

This screen is not relevant for CSD, external CSD and CSD participant users.

Screen Access

- Services >> Additional Services >> Reports >> *Available reports – search/list* screen >> Click on the *details* button
- Services >> Additional Services >> Reports >> *Available reports – search/list* screen >> Click on the *search* and/or *details* button >> *Available report – details* screen >> Click on the *details* button

Privileges

To use this screen, you need the following privilege [**▶** 1200]:

- Report details query

References

User Instructions Part

This screen is part of the following business scenario:

- View available reports

Business Functionality Document

This screen corresponds to the following business function:

- Display generated report details (T2S.GUI.INSE.RPT.0090)

Screenshot

Illustration 99: Available report - statement of executed cancellation instructions for intra-balance movements - details screen

Field Description

General Statement Information	
Report Name	Shows the name of the report.
Delta Mode	Shows if the report is a delta report or not. Possible values are: <input type="checkbox"/> Yes

General Statement Information	
	<input type="checkbox"/> No
Statement Number	Shows the statement number of the report composed of the business date and report type (2-letter abbreviation depending on report type and Delta/Full-Flag) and the sequential number, which is unique in T2S. The number increases for each report.
Report Number	Shows the sequential number of the report which is specific for a report receiving party. This number will only be displayed if the sending user belongs to a report receiving party.
Frequency	Shows the frequency of the report, which is always 'DAILY'.
Scheduled	Shows the name of the business event or time triggering the report creation.
Activity Indicator	Shows whether the report displays activities or only lists information from the possible values: <input type="checkbox"/> True <input type="checkbox"/> False
Covered Period from	Shows the date and time from which the data are covered in the report. Displayed format is: YYYY-MM-DD hh:mm:ss
Covered Period to	Shows the date and time until which the data are covered in the report. Displayed format is: YYYY-MM-DD hh:mm:ss
Report Owner BIC	Shows the BIC of the party whose data are reported.
Report Owner Parent BIC	Shows the parent BIC of the party whose data are reported.
System Entity Wide Report	Shows whether the report is a community report (covering all information referring to a system entity) or a party based report (covering all information referring to a party) from the possible values: <input type="checkbox"/> True <input type="checkbox"/> False
General Information Repetitive block for each cancellation instruction for Intra-Balance Movement	

General Statement Information	
T2S Dedicated Cash Account Owner BIC	Shows the BIC of the party owning the T2S dedicated cash account.
T2S Dedicated Cash Account Owner Parent BIC	Shows the parent BIC of the party owning the dedicated cash account.
T2S Dedicated Cash Account Number	Shows the dedicated cash account number for which the report is created.
Request Reference	Shows the reference number of the request
Cancellation Status	Shows the status of the instruction from the possible values: <input type="checkbox"/> DEND (for denied) <input type="checkbox"/> NDEN (for not denied)
Reason Code	Shows the code of the reason why the instruction has a certain settlement status according to ISO20022.
Reason Code Description	Shows the detailed description of the reason code.
Execution Status	Shows the execution status of the instruction from the possible values: <input type="checkbox"/> EXCD (for executed) <input type="checkbox"/> NEXD (for not executed)
Reason Code	Shows the code of the reason why the instruction has a certain settlement status according to ISO 20022.
Reason Code Description	Shows the detailed description of the reason code.
Last Update of Status	Shows the date and time of the last status update. Displayed format is: YYYY-MM-DD hh:mm:ss:µsµsµsµsµs
Referenced Instruction	
References	
Account Owner Reference	Shows the identification of the instruction assigned by the T2S delivering/receiving party.
Account Servicer Reference	Shows the identification of the instruction assigned by the account servicer.
Third Party Reference	Shows the identification of the instruction assigned by a third party.

General Statement Information	
Intra-Balance Movement Reference	Shows the identification of the intra-balance movement.
Instruction Details	
Intended Settlement Date	Shows the date when the instruction is forwarded to settlement for the first time. Displayed format is: YYYY-MM-DD
Priority	Shows the priority of the payment instruction assigned by the originator of the instruction from the possible values: <ul style="list-style-type: none"> <input type="checkbox"/> High <input type="checkbox"/> Normal <input type="checkbox"/> Reserved <input type="checkbox"/> Top
Settlement Amount	Shows the amount as stated in the settlement instruction.
Currency	Shows the currency code.
Restriction Reference	Shows the identification of the restriction assigned by T2S.
Balance from Type	Shows the code to identify the restriction type for the balance from.
Issuer	Shows the entity assigning the identification. The fixed value is 'T2S'.
Scheme Name	Shows the name of the scheme.
Balance to Type	Shows the code to identify the restriction type for the balance to.
Issuer	Shows the entity assigning the identification. The fixed value is 'T2S'.
Scheme Name	Shows the name of the scheme.

2.4.1.8 Available Report - Statement of Executed Cancellation Instructions for Intra-Position Movements and Settlement Instructions - Details Screen

Context of Usage

This screen displays detailed information on the selected executed cancellation instructions for intra-position movements and settlement instruction. The report displayed in this screen has to be already created in accordance with its report configuration.

This screen is not relevant for CB and payment bank/settlement bank users.

- Screen Access**
- Services >> Additional Services >> Reports >> *Available reports – search/list* screen >> Click on the *details* button
 - Services >> Additional Services >> Reports >> *Available reports – search/list* screen >> Click on the *search* and/or *details* button >> *Available report – details* screen >> Click on the *details* button

Privileges To use this screen, you need the following privilege [**▶ 1200**]:

- Report details query

References **User Instructions Part**

This screen is part of the following business scenario:

- View available reports

Business Functionality Document

This screen corresponds to the following business function:

- Display generated report details (T2S.GUI.INSE.RPT.0090)

Screenshot

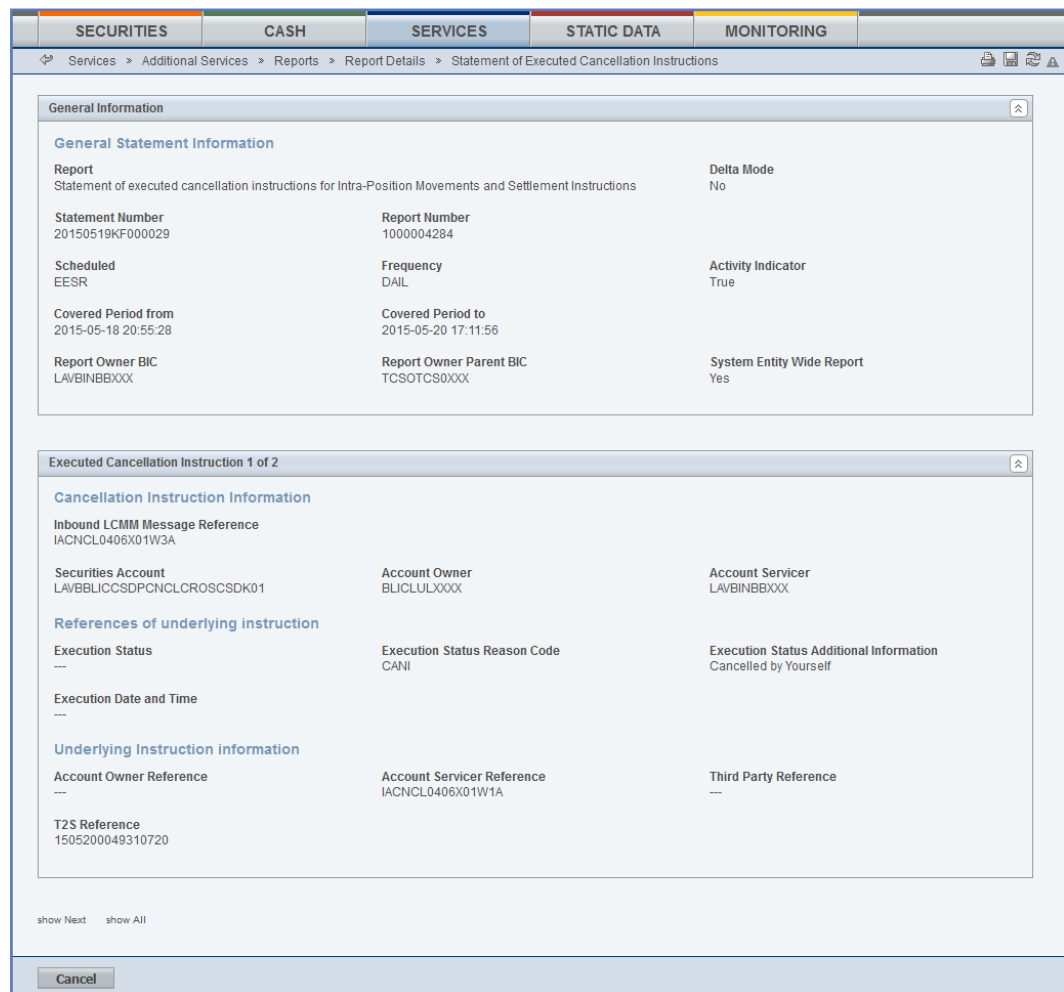

The screenshot displays the 'Statement of Executed Cancellation Instructions' details screen. The interface features a navigation bar with tabs for SECURITIES, CASH, SERVICES, STATIC DATA, and MONITORING. The main content is organized into two primary sections:

- General Information:** This section provides an overview of the report, including:
 - General Statement Information:** Report (Statement of executed cancellation instructions for Intra-Position Movements and Settlement Instructions), Delta Mode (No), Statement Number (20150519KF000029), Report Number (100004284), Scheduled (EESR), Frequency (DAIL), Activity Indicator (True), Covered Period from (2015-05-18 20:55:28), Covered Period to (2015-05-20 17:11:56), Report Owner BIC (LAVBINBBXXX), Report Owner Parent BIC (TCSOTCS0XXX), and System Entity Wide Report (Yes).
- Executed Cancellation Instruction 1 of 2:** This section details a specific instruction:
 - Cancellation Instruction Information:** Inbound LCMM Message Reference (IACNCL0406X01W3A), Securities Account (LAVBBLICSDPCNLCROSCSDK01), Account Owner (BLICLULXXX), and Account Servicer (LAVBINBBXXX).
 - References of underlying instruction:** Execution Status (---), Execution Status Reason Code (CANI), and Execution Status Additional Information (Cancelled by Yourself).
 - Execution Date and Time:** ---
 - Underlying Instruction information:** Account Owner Reference (---), Account Servicer Reference (IACNCL0406X01W1A), and Third Party Reference (---).
 - T2S Reference:** 1505200049310720

At the bottom of the screen, there are controls for 'show Next', 'show All', and a 'Cancel' button.

Illustration 100: Available report - statement of executed cancellation instructions for intra-position movements and settlement instructions - details screen

Field Description	General Statement Information	
Report Name		Shows the name of the report.
Delta Mode		Shows if the report is a delta report or not. Possible values are: <input type="checkbox"/> Yes <input type="checkbox"/> No
Statement Number		Shows the statement number of the report composed of the business date and report type (2-letter abbreviation depending on report type and Delta/Full-Flag) and the sequential number, which is unique in T2S. The number increases for each report.
Report Number		Shows the sequential number of the report which is specific for a report receiving party. This number will only be displayed if the sending user belongs to a report receiving party.
Frequency		Shows the frequency of the report from the possible value: <input type="checkbox"/> DAILY (for reports created on a daily basis)
Scheduled		Shows the name of the business event or time triggering the report creation.
Activity Indicator		Shows whether the report displays activities or only lists information from the possible values: <input type="checkbox"/> True <input type="checkbox"/> False
Covered Period from		Shows the date and time from which the data are covered in the report. Displayed format is: YYYY-MM-DD hh:mm:ss
Covered Period to		Shows the date and time until which the data are covered in the report. Displayed format is: YYYY-MM-DD hh:mm:ss
Report Owner BIC		Shows the BIC of the party whose data are reported.
Report Owner Parent BIC		Shows the parent BIC of the party whose data are reported.
System Entity Wide Report		Shows whether the report is a community report (covering all information referring to a system entity) or a party based report (covering all information referring to a party) from the possible values:

General Statement Information	
	<input type="checkbox"/> Yes <input type="checkbox"/> No
Cancellation Instruction Information	
Inbound LCMM Message Reference	Shows the reference assigned for a cancellation instruction by the sending party.
Securities Account Information	
Securities Account Number	Shows the number of the securities account.
Securities Account Owner BIC	Shows the BIC of the party owning the securities account.
Securities Account Servicer BIC	Shows the BIC of the securities account owner system entity.
Processing Status of the cancellation instruction	
Execution Status	Shows the execution status of the instruction from the possible values: <input type="checkbox"/> EXCD (for executed) <input type="checkbox"/> NEXD (for not executed)
Execution Status Reason Code	Shows the reason code according to ISO20022 why the related instruction is cancelled or the related cancellation request is executed.
Execution Status Additional Information	Shows additional information about the reason of the execution.
Execution Date and Time	Shows the business date when the LCMM instruction is executed or totally settled. Displayed format is: YYYY-MM-DD hh:mm:ss
Underlying Instruction Information	
Account Owner Reference	Shows the reference of an instruction as assigned by the T2S delivering/receiving party.
Account Servicer Reference	Shows the identification of the transaction assigned by the account servicer.
Third Party Reference	Shows the identification of the instruction assigned by a third party.
T2S Reference	Shows the identification of the instruction assigned by T2S.

General Statement Information	
ISIN	Shows the ISIN of the security.
Instruction Type	Shows the type of the instruction from the possible values: <ul style="list-style-type: none"> <input type="checkbox"/> SI (for settlement instruction) <input type="checkbox"/> SR (for settlement restriction)
Intended Settlement Date	Shows the date when the instruction is forwarded to settlement for the first time. Displayed format is: YYYY-MM-DD
Trade Date	Shows the date when the contract was made. Displayed format is: YYYY-MM-DD
Original Settlement Unit	Shows the number of securities which shall be settled.
Original Settlement Quantity Face Amount	Shows the face amount of securities which shall be settled.
Original Settlement Amount	Shows the amount as stated in the settlement instruction.
Currency	Shows the currency code.
Debit Credit Indicator	Shows if an operation is a credit or a debit from the possible values: <ul style="list-style-type: none"> <input type="checkbox"/> CRDT (for credit) <input type="checkbox"/> DBIT (for debit)
Priority	Shows the priority of the payment instruction assigned by the originator of the instruction from the possible values: <ul style="list-style-type: none"> <input type="checkbox"/> High <input type="checkbox"/> Normal <input type="checkbox"/> Reserved <input type="checkbox"/> Top
Restriction Reference	Shows the identification of the restriction assigned by T2S.
Restriction Type Balance from	Shows the code to identify the restriction type for the balance from
Issuer	Shows the entity assigning the identification.
Scheme Name	Shows the name of the scheme.

General Statement Information	
Restriction Type Balance to	Shows the code to identify the restriction type for the balance to
Issuer	Shows the entity assigning the identification.
Scheme Name	Shows the name of the scheme.
Settlement Parties	
Delivering Settlement Parties	
This subframe is optional and only available for settlement instruction information	
Delivering Depository	
Party BIC	Shows the BIC of the delivering depository.
Delivering CSD Participant	
Party BIC	Shows the BIC of the CSD participant delivering the securities.
Processing Identification	Shows the unambiguous identification of the transaction as assigned by the delivering party.
Client of the Delivering CSD Participant	
Specifying the party only via party BIC or its name or the triplet of identification, issuer and scheme name.	
Party BIC	Shows the BIC of the client of delivering CSD participant.
Identification	Shows the proprietary identification of the pre-mentioned party BIC.
Issuer	Shows the entity assigning the identification.
Scheme Name	Shows the name of the scheme.
Name	Shows the name of the client of delivering CSD participant.
Delivering Party 3	
Specifying the party only via party BIC or its name or the triplet of identification, issuer and scheme name.	
Party BIC	Shows the BIC of delivering party 3.
Identification	Shows the proprietary identification of the pre-mentioned party BIC.
Issuer	Shows the entity assigning the identification.
Scheme Name	Shows the name of the scheme.
Name	Shows the name of delivering party 3.

General Statement Information	
Delivering Party 4	
Specifying the party only via party BIC or its name or the triplet of identification, issuer and scheme name.	
Party BIC	Shows the BIC of delivering party 4.
Identification	Shows the proprietary identification of the pre-mentioned party BIC.
Issuer	Shows the entity assigning the identification.
Scheme Name	Shows the name of the scheme.
Name	Shows the name of delivering party 4.
Delivering Party 5	
Specifying the party only via party BIC or its name or the triplet of identification, issuer and scheme name.	
Party BIC	Shows the BIC of delivering party 5.
Identification	Shows the proprietary identification of the pre-mentioned party BIC.
Issuer	Shows the entity assigning the identification.
Scheme Name	Shows the name of the scheme.
Name	Shows the name of delivering party 5.
Receiving Settlement Parties	
This subframe is optional and only available for settlement instruction information	
Receiving Depository	
Party BIC	Shows the BIC of the receiving depository.
Underlying Instruction Information – Settlement Parties – Receiving Settlement Parties – Receiving CSD Participant	
Party BIC	Shows the BIC of the CSD receiving the securities.
Processing Identification	Shows the unambiguous identification of the transaction as assigned by the receiving party.
Client of the Receiving CSD Participant	
Specifying the party only via party BIC or its name or the triplet of identification, issuer and scheme name.	
Party BIC	Shows the BIC of the client of receiving CSD participant.
Identification	Shows the proprietary identification of the pre-mentioned party BIC.

General Statement Information	
Issuer	Shows the entity assigning the identification.
Scheme Name	Shows the name of the scheme.
Name	Shows the name of the client of receiving CSD participant.
Receiving Party 3	
Specifying the party only via party BIC or its name or the triplet of identification, issuer and scheme name.	
Party BIC	Shows the BIC of receiving party 3.
Identification	Shows the proprietary identification of the pre-mentioned party BIC.
Issuer	Shows the entity assigning the identification.
Scheme Name	Shows the name of the scheme.
Name	Shows the Name of receiving party 3.
Receiving Party 4	
Specifying the party only via party BIC or its name or the triplet of identification, issuer and scheme name.	
Party BIC	Shows the BIC of receiving party 4.
Identification	Shows the proprietary identification of the pre-mentioned party BIC.
Issuer	Shows the entity assigning the identification.
Scheme Name	Shows the name of the scheme.
Name	Shows the Name of receiving party 4.
Receiving Party 5	
Specifying the party only via party BIC or its name or the triplet of identification, issuer and scheme name.	
Party BIC	Shows the BIC of receiving party 5.
Identification	Shows the proprietary identification of the pre-mentioned party BIC.
Issuer	Shows the entity assigning the identification.
Scheme Name	Shows the name of the scheme.
Name	Shows the Name of receiving party 5.

2.4.1.9 Available Report - Statement of Holdings - Details Screen

Context of Usage	<p>This screen displays detailed information on the selected statement of holdings. No new report will be created by entering this screen. The statement provides information on the securities that are held within a securities account at the time of the report creation.</p> <p>This screen is not relevant for CB and payment bank/settlement bank users.</p>
Screen Access	<ul style="list-style-type: none"><input type="checkbox"/> Services >> Additional Services >> Reports >> <i>Available reports – search/list</i> screen >> Click on the <i>details</i> button<input type="checkbox"/> Services >> Additional Services >> Reports >> <i>Available reports – search/list</i> screen >> Click on the <i>search</i> and/or <i>details</i> button >> <i>Available report – details</i> screen >> Click on the <i>details</i> button
Privileges	<p>To use this screen, you need the following privilege [▶ 1200]:</p> <ul style="list-style-type: none"><input type="checkbox"/> Report details query
References	<p>User Instructions Part</p> <p>This screen is part of the following business scenario:</p> <ul style="list-style-type: none"><input type="checkbox"/> View available reports <p>Business Functionality Document</p> <p>This screen corresponds to the following business function:</p> <ul style="list-style-type: none"><input type="checkbox"/> Display generated report details (T2S.GUI.INSE.RPT.0090)

Screenshot

The screenshot displays the 'Statement of Settlement Allocations' details screen. The interface includes a navigation bar with tabs for SECURITIES, CASH, SERVICES, STATIC DATA, and MONITORING. The main content area is divided into several sections:

- General Information:** Report (Statement of Settlement Allocations), Delta Mode (No), Statement Number (20200221AF00151), Report Number (100025662), Frequency (DAIL), Scheduled (EESR), Activity Indicator (True), Covered Period from (2020-02-20 10:04:15), Covered Period to (2020-02-24 09:28:19), Report Owner BIC (CSDNLA0XXX), Report Owner Parent BIC (TCSOTCSB0XX), System Entity Wide Report (Yes).
- Party Information:** Alleged Party BIC (CSDNLA0XXX), Alleged Party Parent BIC (TCSOTCSB0XX).
- Settlement Allocation 1 of 1:** Instruction References (Account Owner Reference: ddr, Account Servicer Reference: S0119v02, Unique T2S Technical Identifier: 2002190494669862, Third Party Reference: ---, Common Reference: ---), Allegement Status (---), Trade Timeline (Trade Date: 2020-02-20, Settlement Date: 2020-02-20).
- Trade Information:** Securities Movement Type (DELU), Payment Type (APMT), Beneficial Ownership (No), Place of Trade (---), Proprietary Identification (---), Issuer (---), Schema Name (---), ISIN (NLCDNL000023), Name (CSDNLA0XXX / NLCDNL000023), Deal Price (Yielded: ---, Value Type: ---, Rate %: ---), Amount (---, Currency: ---, Number of Days Accrued: ---).
- Settlement Quantity:** Settlement Quantity (60000), Settlement Type (UNIT).
- Settlement Amount:** Credit Debit Indicator (CROT), Settlement Amount (90000), Settlement Currency (EUR), Original Ordered Amount (0), Original Ordered Currency (EUR), Unit Currency (---), Quoted Currency (---), Exchange Rate (---), Resulting Amount (---).
- Status Information:** Cum/Ex Indicator (---), ISO Transaction Type Code (TRAD), Settlement Transaction Condition Indicator (---), Partial Settlement Indicator (PARQ), Market Client Side (---).
- Delivering Settlement Parties:** Delivering CSD (CSDNLA0XXX), Delivering T2S Party (PMBDNL0XXX), Delivering Party - Securities Account (CSDPCDNL0003).
- Receiving Settlement Parties:** Receiving CSD (CSDNLA0XXX), Receiving T2S Party (PMBDNL0XXX).

Illustration 101: Available report – statement of holdings – details screen

Field Description

General Statement Information	
Report Name	Shows the name of the report.
Delta Mode	Shows if the report is a delta report or not. Possible values are: <input type="checkbox"/> Yes

General Statement Information	
	<input type="checkbox"/> No
Statement Number	Shows the statement number of the report composed of the business date and report type (2-letter abbreviation depending on report type and Delta/Full-Flag) and the sequential number, which is unique in T2S. The number increases for each report.
Report Number	Shows the sequential number of the report which is specific for a report receiving party. This number will only be displayed if the sending user belongs to a report receiving party.
Frequency	Shows the frequency of the report from the possible value: <input type="checkbox"/> DAILY (for reports created on a daily basis)
Scheduled	Shows the name of the business event or time triggering the report creation.
Activity Indicator	Shows whether the report displays activities or only lists information from the possible values: <input type="checkbox"/> True <input type="checkbox"/> False
Statement Basis	Shows the basis of the statement from the possible value: <input type="checkbox"/> SETT (for settled) The statement basis is a mandatory field in the message. The ISO message allows several possible values, but T2S allows only 'SETT'.
Sub Account Indicator	Shows if the statement reports holdings at subsafekeeping account level.
Covered Period from	Shows the date and time from which the data are covered in the report. Displayed format is: YYYY-MM-DD hh:mm:ss
Covered Period to	Shows the date and time until which the data are covered in the report. Displayed format is: YYYY-MM-DD hh:mm:ss
Report Owner BIC	Shows the BIC of the party whose data are reported.
Report Owner Parent BIC	Shows the parent BIC of the party whose data are reported.

General Statement Information	
System Entity Wide Report	Shows whether the report is a community report (covering all information referring to a system entity) or a party based report (covering all information referring to a party) from one of the possible values: <input type="checkbox"/> True <input type="checkbox"/> False
Securities Account Information	
Securities Account Information	
Securities Account Number	Shows the number of the securities account on which the report is based.
Securities Account Owner BIC	Shows the BIC of the party owning the securities account.
Securities Account Servicer BIC	Shows the BIC of the party operating the securities account.
Information on the Positions of the Account	
Total Position of a ISIN	
ISIN	Shows the ISIN of the security.
Position Type	Shows the position of the ISIN from the possible values: <input type="checkbox"/> LONG (positive balance) <input type="checkbox"/> SHOR (negative balance)
Settlement Type	Shows the type of settlement from the possible values: <input type="checkbox"/> UNIT (Units) <input type="checkbox"/> FAMT (Face Amount)
Total Quantity	Shows the total quantity of the respective security. Provision of '99999...99' in case oversizing occurs in the integer portion. Truncation of decimals in case oversizing occurs in the decimal portion.
Availability	
Settlement Type	Shows the type of settlement from the possible values: <input type="checkbox"/> UNIT (Units) <input type="checkbox"/> FAMT (Face Amount)
Available Balance	Shows the total quantity the security that is available.

General Statement Information	
	Provision of '99999...99' in case oversizing occurs in the integer portion. Truncation of decimals in case oversizing occurs in the decimal portion.
Settlement Type	Shows the type of settlement from the possible values: <input type="checkbox"/> UNIT (Units) <input type="checkbox"/> FAMT (Face Amount)
Not Available Balance	Shows the total quantity of the security that is not available. Provision of '99999...99' in case oversizing occurs in the integer portion. Truncation of decimals in case oversizing occurs in the decimal portion.
Balance Breakdown per Restriction Processing Type	
Restriction Processing Type	Shows the type of restriction processing.
Settlement Type	Shows the type of settlement from the possible values: <input type="checkbox"/> UNIT (Units) <input type="checkbox"/> FAMT (Face Amount)
Quantity	Shows the quantity of securities in the sub-balance for the market-specific restriction processing type. Provision of '99999...99' in case oversizing occurs in the integer portion. Truncation of decimals in case oversizing occurs in the decimal portion.
Balance Breakdown per Restriction Type	
Restriction Type	Shows the identification and description of a restriction.
Settlement Type	Shows the type of settlement from the possible values: <input type="checkbox"/> UNIT (Units) <input type="checkbox"/> FAMT (Face Amount)
Quantity	Shows the quantity of securities in the sub-balance for the market-specific restriction type. Provision of '99999...99' in case oversizing occurs in the integer portion. Truncation of decimals in case oversizing occurs in the decimal portion.
Quantity Breakdown per Restriction	
Restriction Reference	Shows the identification of the restriction assigned to a restricted securities position by T2S.

General Statement Information	
Settlement Type	Shows the type of settlement from the possible values: <ul style="list-style-type: none"> <input type="checkbox"/> UNIT (Units) <input type="checkbox"/> FAMT (Face Amount)
Quantity	Shows the remaining quantity of a securities position. Provision of '99999...99' in case oversizing occurs in the integer portion. Truncation of decimals in case oversizing occurs in the decimal portion.

2.4.1.10 Available Report - Statement of Pending Amendment Instructions for Intra-Balance Movements - Details Screen

Context of Usage	<p>This screen displays detailed information on the selected statement of pending amendment instructions for intra-balance movements.</p> <p>The report displayed in this screen has to be already created in accordance with its report configuration.</p> <p>This screen is not relevant for CSD users, external CSD users or CSD participants.</p>
Screen Access	<ul style="list-style-type: none"> <input type="checkbox"/> Services >> Additional Services >> Reports >> <i>Available reports – search/list</i> screen >> Click on the <i>details</i> button <input type="checkbox"/> Services >> Additional Services >> Reports >> <i>Available reports – search/list</i> screen >> Click on the <i>search</i> and/or <i>details</i> button >> <i>Available report – details</i> screen >> Click on the <i>details</i> button
Privileges	<p>To use this screen, you need the following privilege [▶ 1201]:</p> <ul style="list-style-type: none"> <input type="checkbox"/> Report details query
References	<p>User Instructions Part</p> <p>This screen is part of the following business scenario:</p> <ul style="list-style-type: none"> <input type="checkbox"/> View available reports <p>Business Functionality Document</p> <p>This screen corresponds to the following business function:</p> <ul style="list-style-type: none"> <input type="checkbox"/> Display generated report details (T2S.GUI.INSE.RPT.0090)

Screenshot

General Statement Information

Report Name Report 1	Mode DELTA
Statement Number 000000000012345	Report Number 12345
Frequency ADHOC	Scheduled End of Day
Activity Indicator True	Report Creation Date and Time 2012-07-05 13:12:54:89456
Covered Period 2012-06-05 00:00:00	Covered Period 2012-06-15 00:00:00
Report Owner BIC PAR1FRPPXXX	Report Owner Parent BIC CSD2ITRDXXX
System Entity Wide Report No	

T2S Dedicated Cash Account Information

T2S Dedicated Cash Account Number 1234567890	T2S Dedicated Cash Account Owner BIC CSD5ITRDXXX	T2S Dedicated Cash Account Servicer BIC PAR3FRPPXXX
--	--	---

Processing Status

Processing Status of the Amendment Instruction

Last Update of Status 2012-06-11 10:22:12:00000	Cancellation Status NDEN	
Execution Status NEXD	Cancellation Status Reason Code ---	Cancellation Status Additional Information ---

Modification Information

Actor Reference 12345	T2S Dedicated Cash Account Servicer Reference 54321	Amendment Instruction Technical Identifier T2S-A-009-AA
Third Party Reference 3RD_BXX	Linkage Type of Instruction LINK	Priority Normal

Link Information

Link Type	User Reference	Instructing Party BIC	Instructing Party Parent BIC	Linked Instruction T2S Technical Identifier	Message Number
INFO	REF-2012-L-2	PAR1FRPPXXX	CSD1DEFFXXX	TECH-ID-12-827301	MSG-ID-3554-12
WITH	REF-2012-L-1	PAR1FRPPXXX	CSD1DEFFXXX	TECH-ID-12-827299	MSG-ID-3421-12

Further Information on Underlying Settlement Restriction

Settlement Amount 123,123,123.12345	Intended Settlement Date 2012-06-12	
Restriction Type Balance from DELI	Restriction Type Balance To BLK1	Restriction Reference 34512
Priority Normal		

Illustration 102: Available report – statement of pending amendment instruction for intra-balance movements – details screen

Field Description

General Statement Information	
Report Name	Shows the name of the report.
Delta Mode	Shows if the report is a delta report or not. Possible values are: <ul style="list-style-type: none"> <input type="checkbox"/> Yes <input type="checkbox"/> No

General Statement Information	
Statement Number	Shows the statement number of the report composed of the business date and report type (2-letter abbreviation depending on report type and Delta/Full-Flag) and the sequential number, which is unique in T2S. The number increases for each report.
Report Number	Shows the sequential number of the report which is specific for a report receiving party. This number will only be displayed if the sending user belongs to a report receiving party.
Frequency	Shows the frequency of the report, which is always 'DAILY'.
Scheduled	Shows the name of the business event or time triggering the report creation.
Activity Indicator	Shows whether the report displays activities or only lists information from the possible values: <input type="checkbox"/> True <input type="checkbox"/> False
Covered Period From	Shows the date and time from which the data are covered in the report. Displayed format is: YYYY-MM-DD hh:mm:ss
Covered Period To	Shows the date and time until which the data are covered in the report. Displayed format is: YYYY-MM-DD hh:mm:ss
Report Owner BIC	Shows the BIC of the party whose data are reported.
Report Owner Parent BIC	Shows the parent BIC of the party whose data are reported.
System Entity Wide Report	Shows whether the report is a community report (covering all information referring to a system entity) or a party based report (covering all information referring to a party) from the possible values: <input type="checkbox"/> Yes <input type="checkbox"/> No
T2S Dedicated Cash Account Information Repetitive Block For Each Amendment Instruction	

General Statement Information	
T2S Dedicated Cash Account Number	Shows the T2S dedicated cash account for which the report is created.
Account Owner Reference	Shows the BIC of the party owning the T2S dedicated cash account.
Account Servicer Reference	Shows the BIC of the party operating the T2S dedicated cash account.
Processing Status	
Repetitive Block For Each Amendment Instruction	
Processing Status of the Amendment Instruction	
Last Update of Status	Shows the date and time of the last status update. Displayed format is: YYYY-MM-DD hh:mm:ss:µsµsµsµsµs
Cancellation Status	Shows the status of the instruction from the possible values: <input type="checkbox"/> cancelled <input type="checkbox"/> not cancelled
Execution Status	Shows the execution status of the instruction from the possible values: <input type="checkbox"/> EXCD (for executed) <input type="checkbox"/> NEXD (for not executed)
Cancellation Status Reason Code	Shows the reason code for the cancellation.
Cancellation Status Additional Information	Shows additional information on the cancellation status.
Modification Information	
Actor Reference	Shows the identification of the instruction assigned by the T2S actor.
References assigned to the settlement restriction on the Cash Balance	
Account Owner Reference	Shows the identification of the instruction as assigned by the T2S Delivering/Receiving Party.
Account Servicer Reference	Shows the identification of the instruction as assigned by the account servicer.
Amendment Instruction Technical Identifier	Shows the identification of the amendment instruction assigned by T2S.

General Statement Information	
Third Party Reference	Shows the identification of the instruction assigned by a third party.
Linkage Type of Instruction	Shows the linkage type of the instruction from the possible values: <ul style="list-style-type: none"> <input type="checkbox"/> LINK (for linked) <input type="checkbox"/> UNLK (for unlinked)
Priority	Shows the priority of the payment instruction assigned by the originator of the instruction from the possible values: <ul style="list-style-type: none"> <input type="checkbox"/> High <input type="checkbox"/> Normal <input type="checkbox"/> Reserved <input type="checkbox"/> Top
Link Information	
Link Type	Shows the link type of the instruction from the possible values: <ul style="list-style-type: none"> <input type="checkbox"/> AFTE (Instruction has to be settled after or at the same time as the linked instruction) <input type="checkbox"/> BEFO (Instruction has to be settled before or at the same time as the linked instruction) <input type="checkbox"/> WITH (Instruction has to be settled at the same time as the linked instruction)
Actor Reference	Shows the identification of the instruction assigned by the instructing party.
Instructing Party BIC	Shows the BIC of the instructing party.
Linked Instruction T2S Technical Identifier	Shows the technical identification of the linked instruction.
Message Number	Shows the ISO code of the XML message.
Further Information on Underlying Settlement Restriction	
Repetitive Block For Each Amendment Instruction	
Settlement Amount	Shows the amount as stated in the settlement restriction.
Intended Settlement Date	Shows the date when the instruction is forwarded to settlement for the first time. Displayed format is: YYYY-MM-DD

General Statement Information	
Restriction Type Balance from	Shows the code to identify the restriction type for the balance from.
Restriction Type Balance To	Shows the code to identify the restriction type for the balance to.
Restriction Reference	Shows the identification of the restriction assigned by T2S.
Priority	Shows the priority of the payment instruction assigned by the originator of the instruction from the possible values: <ul style="list-style-type: none"> <input type="checkbox"/> High <input type="checkbox"/> Normal <input type="checkbox"/> Reserved <input type="checkbox"/> Top

2.4.1.11 Available Report - Statement of Pending Amendment Instructions for Intra-Position Movements and Settlement Instructions - Details Screen

Context of Usage

This screen displays detailed information on the selected statement of pending amendment instructions for intra-position movements and settlement instructions.

The report displayed in this screen has to be already created in accordance with its report configuration.

This screen is not relevant for CB and payment bank/settlement bank users.

Screen Access

Services >> Additional Services >> Reports >> *Available reports – search/list* screen >> Click on the *details* button

Services >> Additional Services >> Reports >> *Available reports – search/list* screen >> Click on the *search* and/or *details* button >> *Available report – details* screen >> Click on the *details* button

Privileges

To use this screen, you need the following privilege [▶ 1201]:

Report details query

References

User Instructions Part

This screen is part of the following business scenario:

View available reports

Business Functionality Document

This screen corresponds to the following business function:

Display generated report details (T2S.GUI.INSE.RPT.0090)

Screenshot

Services > Additional Services > Reports > Report Details > Statement of pending amendment instructions for Intra-Position

General Information

General Statement Information

Report
Statement of pending amendment instructions for Intra-Position Movements and Settlement Instructions

Delta Mode Yes	Statement Number 20160628RD000326	Report Number 1000003891
Frequency DAIL	Scheduled C1R1	Activity Indicator False
Covered Period from 2016-06-27 11:22:24	Covered Period to 2016-06-27 12:38:43	Report Owner BIC FITBITX1XXX
Report Owner Parent BIC TCSOTCS0XXX	System Entity Wide Report Yes	

Cancel

Illustration 103: Available report – statement of pending amendment instructions for intra-position movements and settlement instructions – details screen

Field
Description

General Statement Information	
Report Name	Shows the name of the report.
Delta Mode	Shows if the report is a delta report or not. Possible values are: <input type="checkbox"/> Yes <input type="checkbox"/> No
Statement Number	Shows the statement number of the report composed of the business date and report type (2-letter abbreviation depending on report type and Delta/Full-Flag) and the sequential number, which is unique in T2S. The number increases for each report.
Report Number	Shows the sequential number of the report which is specific for a report receiving party. This number will only be displayed if the sending user belongs to a report receiving party.
Scheduled	Shows the name of the business event or time triggering the report creation.
Frequency	Shows the frequency of the report, which is always 'DAILY'.
Activity Indicator	Shows whether the report displays activities or only lists information from the possible values: <input type="checkbox"/> True <input type="checkbox"/> False

General Statement Information	
Covered Period from	Shows the date and time from which the data are covered in the report. Displayed format is: YYYY-MM-DD hh:mm:ss
Covered Period to	Shows the date and time until which the data are covered in the report. Displayed format is: YYYY-MM-DD hh:mm:ss
Report Owner BIC	Shows the BIC of the party whose data are reported.
Report Owner Parent BIC	Shows the parent BIC of the party whose data are reported.
System Entity Wide Report	Shows whether the report is a community report (covering all information referring to a system entity) or a party based report (covering all information referring to a party) from the possible values: <input type="checkbox"/> Yes <input type="checkbox"/> No
Amendment Instruction or Hold/Release Instruction Repetitive block for each amendment or hold/release instruction	
Securities Account Information	
Securities Account Number	Shows the number of the securities account on which the report is based.
Securities Account Owner BIC	Shows the BIC of the party owning the securities account.
Securities Account Owner Parent BIC	Shows the parent BIC of the party owning the securities account.
Status Information	
Execution Status	Shows the execution status of the instruction from the possible values: <input type="checkbox"/> EXCD (for executed) <input type="checkbox"/> NEXD (for not executed)
Instruction Status	Shows the status of the instruction from the possible values: <input type="checkbox"/> DEND (for denied) <input type="checkbox"/> NDEN (for not denied)
Last Update of Status	Shows the date and time of the last status update. Displayed format is: YYYY-MM-DD hh:mm:ss

General Statement Information	
Instruction Information for Hold/Release Instruction	
This subframe is optional and only available for hold/release instructions	
Inbound Individual Message Identification	Shows the identification of the inbound message.
Hold/Release Instruction Technical Identifier	Shows the unique identification of the hold/release instruction assigned by T2S.
Hold Status Type	Shows the status of the hold type from the possible values: <ul style="list-style-type: none"> <input type="checkbox"/> CoSD Hold <input type="checkbox"/> CSD Hold <input type="checkbox"/> CSD Validation Hold <input type="checkbox"/> Party Hold
On Hold Indicator	Shows whether the instruction is on hold from the possible values: <ul style="list-style-type: none"> <input type="checkbox"/> YES <input type="checkbox"/> NO
CoSD Rule Identification	Shows the identification of the respective CoSD rule.
Instruction Information for Amendment Instructions	
This subframe is optional and only available for amendment instructions	
Amendment Instruction Technical Identifier	Shows the unique identification of the amendment instruction assigned by T2S.
Priority	Shows the priority of the payment instruction assigned by the originator of the instruction from the possible values: <ul style="list-style-type: none"> <input type="checkbox"/> High <input type="checkbox"/> Normal <input type="checkbox"/> Reserved <input type="checkbox"/> Top
Partial Settlement Indicator	Shows if the settlement instruction is allowed to be subject to partial settlement from the possible values: <ul style="list-style-type: none"> <input type="checkbox"/> NPAR (for no partial settlement allowed)

General Statement Information	
	<input type="checkbox"/> PART (for partial settlement allowed without restrictions) <input type="checkbox"/> PARC (for partial settlement allowed but the settlement amount must not be below the threshold) <input type="checkbox"/> PARQ (for partial settlement allowed but the quantity must not be below the threshold)
Instruction Information for amendment instructions - Linkage Information	
This subframe is optional and only available for amendment instructions	
Linkage Type of Instruction	Shows the linkage type of the instruction from the possible values: <input type="checkbox"/> LINK (for linked) <input type="checkbox"/> UNLK (for unlinked)
Instruction Information for amendment instructions - Linkage Information – Instruction Link	
This subframe is optional and only available for amendment instructions	
Link Type	Shows the link type of the instruction from the possible values: <input type="checkbox"/> AFTE (Instruction has to be settled after or at the same time as the linked instruction) <input type="checkbox"/> BEFO (Instruction has to be settled before or at the same time as the linked instruction) <input type="checkbox"/> WITH (Instruction has to be settled at the same time as the linked instruction)
Linked Instruction T2S Technical Identifier	Shows the identification of the linked instruction assigned by T2S.
Linked Instruction Reference of Party	Shows the T2S actor reference of the LCMM instruction with which the relevant LCMM instruction is linked. If there is more than 1 link between LCMM instructions, the settlement link indicator is shown.
Received Account Owner BIC	Shows the BIC of the party who owns the identification of the instruction/pool to which this instruction is linked.
System Entity Reference Owner	Shows the identification of the system entity of the T2S party owner.
Message Number	Shows the identification of the message referenced in the linkage sequence.

General Statement Information	
Pool Instruction Reference	Shows the identification of the pool groups.
Intra-Position Movement Information	
This subframe is optional and only available for intra-position movement information	
ISIN	Shows the ISIN of the security.
Original Settlement Quantity	Shows the quantity of securities to be settled.
Settlement Type	Shows the type of settlement from the possible values: <input type="checkbox"/> UNIT (Units) <input type="checkbox"/> FAMT (Face amount)
Intended Settlement Date	Shows the date when the instruction is forwarded to settlement for the first time. Displayed format is: YYYY-MM-DD
Restriction Type Balance From	Shows a restriction type code of the position of a securities account which is debited.
Restriction Type Balance To	Shows a restriction type code of the position of a securities account which is credited.
Restriction Reference	Shows the identification of the restriction assigned by T2S.
Priority	Shows the priority of the payment instruction assigned by the originator of the instruction from the possible values: <input type="checkbox"/> High <input type="checkbox"/> Normal <input type="checkbox"/> Reserved <input type="checkbox"/> Top
Intra-Position Movement Technical Identifier	Shows the unique technical identification of the intra-position movement assigned by T2S.
Account Owner Reference	Shows the identification of the instruction assigned by the delivering/receiving party.
Account Servicer Reference	Shows the identification of the transaction assigned by the CSD.
Third Party Reference	Shows the identification of the instruction assigned by a third party.

General Statement Information	
Settlement Instruction Information	
This subframe is optional and only available for settlement instruction information	
Settlement Instruction Technical Identifier	Shows the unique identification of the settlement instruction assigned by T2S.
Account Owner Reference	Shows the identification of the settlement instruction assigned by the delivering/receiving party.
Account Servicer Reference	Shows the identification of the settlement instruction assigned by the CSD.
Third Party Reference	Shows the identification of the settlement instruction assigned by the third party.
ISIN	Shows the ISIN of the security.
Original Settlement Quantity	Shows the quantity of securities to be settled.
Settlement Type	Shows the type of settlement from the possible values: <input type="checkbox"/> UNIT (Units) <input type="checkbox"/> FAMT (Face amount)
Original Settlement Amount	Shows the amount as stated in the settlement instruction.
Settlement Currency	Shows the unique code of the currency.
Debit Credit Indicator	Shows if an operation is a credit or a debit from the possible values: <input type="checkbox"/> CRDT (for credit) <input type="checkbox"/> DBIT (for debit)
Intended Settlement Date	Shows the date when the instruction is forwarded to settlement for the first time. Displayed format is: YYYY-MM-DD
Trade Date	Shows the date when the contract was made. Displayed format is: YYYY-MM-DD
Settlement Parties	
This subframe is optional and only available for settlement instruction information	
Delivering Settlement Parties	
Delivering Depository	

General Statement Information	
Party BIC	Shows the BIC of the delivering depository.
Delivering CSD Participant	
Party BIC	Shows the BIC of the CSD participant delivering the securities.
Processing Identification	Shows the unambiguous identification of the transaction as assigned by the delivering party.
Client of the Delivering CSD Participant	
Specifying the party only via party BIC or its name or the triplet of identification, issuer and scheme name.	
Party BIC	Shows the BIC of the client of delivering CSD participant.
Identification	Shows the proprietary identification of the pre-mentioned party BIC.
Issuer	Shows the entity assigning the identification.
Scheme Name	Shows the name of the scheme.
Name	Shows the name of the client of delivering CSD participant.
Delivering Party 3	
Specifying the party only via party BIC or its name or the triplet of identification, issuer and scheme name.	
Party BIC	Shows the BIC of delivering party 3.
Identification	Shows the proprietary identification of the pre-mentioned party BIC.
Issuer	Shows the entity assigning the identification.
Scheme Name	Shows the name of the scheme.
Name	Shows the BIC of delivering party 3.
Delivering Party 4	
Specifying the party only via party BIC or its name or the triplet of identification, issuer and scheme name.	
Party BIC	Shows the BIC of delivering party 4.
Identification	Shows the proprietary identification of the pre-mentioned party BIC.
Issuer	Shows the entity assigning the identification.
Scheme Name	Shows the name of the scheme.
Name	Shows the name of delivering party 4.

General Statement Information	
Delivering Party 5	
Specifying the party only via party BIC or its name or the triplet of identification, issuer and scheme name.	
Party BIC	Shows the BIC of delivering party 5.
Identification	Shows the proprietary identification of the pre-mentioned party BIC.
Issuer	Shows the entity assigning the identification. The fixed value is 'T2S'.
Scheme Name	Shows the name of the scheme.
Name	Shows the name of delivering party 5.
Receiving Settlement Parties	
Receiving Depository	
Party BIC	Shows the BIC of the receiving depository.
Receiving CSD Participant	
Party BIC	Shows the BIC of the CSD receiving the securities.
Processing Identification	Shows the unambiguous identification of the transaction as assigned by the receiving party.
Client of the Receiving CSD Participant	
Specifying the party only via party BIC or its name or the triplet of identification, issuer and scheme name.	
Party BIC	Shows the BIC of the client of receiving CSD participant.
Identification	Shows the proprietary identification of the pre-mentioned party BIC.
Issuer	Shows the entity assigning the identification.
Scheme Name	Shows the name of the scheme.
Name	Shows the name of the client of receiving CSD participant.
Receiving Party 3	
Specifying the party only via party BIC or its name or the triplet of identification, issuer and scheme name.	
Party BIC	Shows the BIC of receiving party 3.
Identification	Shows the proprietary identification of the pre-mentioned party BIC.
Issuer	Shows the entity assigning the identification.
Scheme Name	Shows the name of the scheme.

General Statement Information	
Name	Shows the Name of receiving party 3.
Receiving Party 4	
Specifying the party only via party BIC or its name or the triplet of identification, issuer and scheme name.	
Party BIC	Shows the BIC of receiving party 4.
Identification	Shows the proprietary identification of the pre-mentioned party BIC.
Issuer	Shows the entity assigning the identification.
Scheme Name	Shows the name of the scheme.
Name	Shows the Name of receiving party 4.
Receiving Party 5	
Specifying the party only via party BIC or its name or the triplet of identification, issuer and scheme name.	
Party BIC	Shows the BIC of receiving party 5.
Identification	Shows the proprietary identification of the pre-mentioned party BIC.
Issuer	Shows the entity assigning the identification.
Scheme Name	Shows the name of the scheme.
Name	Shows the Name of receiving party 5.
Status Information	
Repetitive Block For Each Hold/Release Instruction Or Amendment Instruction	
Cancellation Status Reason Code	Shows the reason code of the cancellation status.

2.4.1.12 Available Report - Statement of Pending Cancellation Instructions for Intra-Balance Movements - Details Screen

Context of Usage

This screen displays detailed information on the selected statement of pending cancellation instructions for intra-balance movements. The report displayed in this screen has to be already created in accordance with its report configuration.

This screen is not relevant for CSD, external CSD and CSD participant users.

Screen Access

Services >> Additional Services >> Reports >> *Available reports – search/list* screen >> Click on the *details* button

- Services >> Additional Services >> Reports >> **Available reports – search/list** screen >> Click on the **search** and/or **details** button >> **Available report – details** screen >> Click on the **details** button

Privileges To use this screen, you need the following privilege [**▶ 1201**]:

- Report details query

References **User Instructions Part**

This screen is part of the following business scenario:

- View available reports

Business Functionality Document

This screen corresponds to the following business function:

- Display generated report details (T2S.GUI.INSE.RPT.0090)

Screenshot

Illustration 104: Available report – statement of pending cancellation instruction for intra-balance movements – details screen

Field

Description

General Statement Information	
Report Name	Shows the name of the report.
Delta Mode	Shows if the report is a delta report or not. Possible values are: <ul style="list-style-type: none"> <input type="checkbox"/> Yes <input type="checkbox"/> No
Statement Number	Shows the sequential number of the report assigned by the account servicer. The number increases for each report.
Report Number	Shows the sequential number of the report which is specific for a report receiving party.

General Statement Information	
	This number will only be displayed if the sending user belongs to a report receiving party.
Frequency	Shows the frequency of the report, which is always 'DAILY'.
Scheduled	Shows the name of the business event or time triggering the report creation.
Activity Indicator	Shows whether the report displays activities or only lists information from the possible values: <input type="checkbox"/> True <input type="checkbox"/> False
Covered Period from	Shows the date and time from which the data are covered in the report. Displayed format is: YYYY-MM-DD hh:mm:ss
Covered Period to	Shows the date and time until which the data are covered in the report. Displayed format is: YYYY-MM-DD hh:mm:ss
Report Owner BIC	Shows the BIC of the party whose data are reported.
Report Owner Parent BIC	Shows the parent BIC of the party whose data are reported.
System Entity Wide Report	Shows whether the report is a community report (covering all information referring to a system entity) or a party based report (covering all information referring to a party). from the possible values: <input type="checkbox"/> Yes <input type="checkbox"/> No
T2S Dedicated Cash Account Information	
Repetitive Block For Each Cancellation Instruction For Intra-Balance Movements	
T2S Dedicated Cash Account Owner BIC	Shows the BIC of the party owning the T2S dedicated cash account owner.
T2S Dedicated Cash Account Owner Parent BIC	Shows the parent BIC of the party owning the dedicated cash account.
T2S Dedicated Cash Account Number	Shows the T2S dedicated cash account for which the report is created.

General Statement Information	
Cancellation Status	Shows the status of the instruction from the possible values: <input type="checkbox"/> DEND (for denied) <input type="checkbox"/> NDEN (for not denied)
Reason Code	Shows code of the reason why the instruction has a certain settlement status according to ISO20022.
Reason Code Description	Shows the detailed description of the reason code.
Execution Status	Shows the execution status of the instruction from the possible values: <input type="checkbox"/> EXCD (for executed) <input type="checkbox"/> NEXD (for not executed)
Reason Code	Shows the code of the reason why the instruction has a certain settlement status according to ISO20022.
Reason Code Description	Shows the detailed description of the reason code.
Request Reference	Shows the Inbound LCMM Message Reference
Last Update of Status	Shows the date and time of the last status update. Displayed format is: YYYY-MM-DD hh:mm:ss
Referenced Instruction	
Repetitive Block For Each Cancellation Instruction For Intra-Balance Movements	
References	
Account Owner Reference	Shows the identification of the instruction assigned by the T2S delivering/receiving party.
Account Servicer Reference	Shows the identification of the instruction assigned by the account servicer.
Third Party Reference	Shows the identification of the instruction assigned by a third party.
Intra-Balance Movement Reference	Shows the unique identification of the intra-balance movement assigned by T2S.
Instruction Details	
Intended Settlement Date	Shows the date when the instruction is forwarded to settlement for the first time. Displayed format is: YYYY-MM-DD

General Statement Information	
Priority	Shows the priority of the payment instruction assigned by the originator of the instruction from the possible values: <input type="checkbox"/> High <input type="checkbox"/> Normal <input type="checkbox"/> Reserved <input type="checkbox"/> Top
Settlement Amount	Shows the amount as stated in the settlement instruction.
Currency	Shows the currency code.
Restriction Reference	Shows the identification of the restriction assigned by T2S.
Balance from Type	Shows a code to identify the restriction.
Issuer	Shows the entity that assigns the identification.
Scheme Name	Shows the description of the scheme.
Balance to Type	Shows a code to identify the restriction.
Issuer	Shows the entity that assigns the identification.
Scheme Name	Shows the description of the scheme.

2.4.1.13 Available Report - Statement of Pending Cancellation Instructions for Intra-Position Movements and Settlement Instructions - Details Screen

Context of Usage	This screen displays detailed information on pending cancellation instructions for intra-position movements and settlement instructions. The report displayed in this screen has to be already created in accordance with its report configuration. This screen is not relevant for CB and payment bank/settlement bank users.
Screen Access	<ul style="list-style-type: none"> <input type="checkbox"/> Services >> Additional Services >> Reports >> <i>Available reports – search/list</i> screen >> Click on the <i>details</i> button <input type="checkbox"/> Services >> Additional Services >> Reports >> <i>Available reports – search/list</i> screen >> Click on the <i>search</i> and/or <i>details</i> button >> <i>Available report – details</i> screen >> Click on the <i>details</i> button
Privileges	To use this screen, you need the following privilege [▶ 1202]: <input type="checkbox"/> Report details query
References	User Instructions Part This screen is part of the following business scenario: <input type="checkbox"/> View available reports

Business Functionality Document

This screen corresponds to the following business function:

- Display generated report details (T2S.GUI.RPT.0090)

Screenshot

General Information	
General Statement Information	
Report Statement of pending cancellation instructions for Intra-Position Movements and Settlement Instructions	Delta Mode Yes
Statement Number 20170116LD000370	Report Number 100003842
Scheduled 16:00	Frequency DAIL
Covered Period from 2017-01-13 14:09:00	Covered Period to 2017-01-13 16:00:00
Report Owner BIC CSDYNAMM002	Report Owner Parent BIC TCSOTCS0XXX
	System Entity Wide Report No

Illustration 105: Available report – statement of pending cancellation instructions for intra-position movements and settlement instruction – details screen

Field Description

General Statement Information	
Report Name	Shows the name of the report.
Delta Mode	Shows if the report is a delta report or not. Possible values are: <input type="checkbox"/> Yes <input type="checkbox"/> No
Statement Number	Shows the statement number of the report composed of the business date and report type (2-letter abbreviation depending on report type and delta/full-flag) and the sequential number, which is unique in T2S. The number increases for each report.
Report Number	Shows the sequential number of the report which is specific for a report receiving party. This number will only be displayed if the sending user belongs to a report receiving party.
Scheduled	Shows the name of the business event or time triggering the report creation.
Frequency	Shows the frequency of the report from the possible value: <input type="checkbox"/> DAILY (for reports created on a daily basis)

General Statement Information	
Activity Indicator	Shows whether the report displays activities or only lists information from the possible values: <input type="checkbox"/> True <input type="checkbox"/> False
Covered Period from	Shows the date and time from which the data are covered in the report. Displayed format is: YYYY-MM-DD hh:mm:ss
Covered Period to	Shows the date and time until which the data are covered in the report. Displayed format is: YYYY-MM-DD hh:mm:ss
Report Owner BIC	Shows the BIC of the party whose data are reported.
Report Owner Parent BIC	Shows the parent BIC of the party whose data are reported.
System Entity Wide Report	Shows whether the report is a community report (covering all information referring to a system entity) or a party based report (covering all information referring to a party) from the possible values: <input type="checkbox"/> Yes <input type="checkbox"/> No
Cancellation Instruction Information	
Actor Reference	Shows the reference assigned for a cancellation instruction by the T2S actor.
Securities Account Information	
Securities Account Number	Shows the number of the securities account.
Securities Account Owner BIC	Shows the BIC of the securities account.
Securities Account Servicer BIC	Shows the BIC of the party operating the securities account.
Processing Status of the Cancellation Instruction	
Execution Status	Shows the execution status of the instruction from the possible values: <input type="checkbox"/> EXCD (for executed) <input type="checkbox"/> NEXD (for not executed)

General Statement Information	
Execution Status Reason Code	Shows the ISO 20022 reason code why the related instruction is cancelled or the related cancellation request is executed.
Execution Status Additional Information	Shows additional information about the execution status.
Cancellation Status	Shows the status of the instruction from the possible values: <input type="checkbox"/> DEND (for denied) <input type="checkbox"/> NDEN (for not denied)
Cancellation Status Reason Code	Shows the reason code for the cancellation.
Cancellation Status Additional Information	Shows additional information on the cancellation status.
Acknowledged Accepted	Shows whether the instruction passed all business validations within T2S from the possible values: <input type="checkbox"/> True <input type="checkbox"/> False
Pending Cancellation	Shows whether the cancellation instruction is pending from the possible values: <input type="checkbox"/> True <input type="checkbox"/> False
Pending Cancellation Reason Code	Shows the reason code why the cancellation instruction is pending.
Last Update of Status	Shows the date and time of the last status update. Displayed format is: YYYY-MM-DD hh:mm:ss
References of Underlying Instruction	
Account Owner Reference	Shows the reference of an instruction which is assigned by the T2S delivering/receiving party.
Account Servicer Reference	Shows the identification of the transaction assigned by the CSD.
Third Party Reference	Shows the identification of the instruction assigned by a third party.

General Statement Information	
T2S Reference	Shows the identification of the instruction assigned by T2S.
Underlying Instruction Information	
Instruction Type	Shows the type of instruction from the possible values: <ul style="list-style-type: none"> <input type="checkbox"/> SI (for settlement instruction) <input type="checkbox"/> SR (for settlement restriction)
ISIN	Shows the ISIN of the security.
Intended Settlement Date	Shows the date when the instruction is forwarded to settlement for the first time. Displayed format is: YYYY-MM-DD
Trade Date	Shows the date when the contract was made. Displayed format is: YYYY-MM-DD
Original Settlement Unit	Shows the number of securities which shall be settled.
Original Settlement Quantity Face Amount	Shows the face amount of securities which shall be settled.
Original Settlement Amount	Shows the amount as stated in the settlement instruction.
Currency	Shows the currency code.
Debit Credit Indicator	Shows if an operation is a credit or a debit from the possible values: <ul style="list-style-type: none"> <input type="checkbox"/> CRDT (for credit) <input type="checkbox"/> DBIT (for debit)
Priority	Shows the priority of the payment instruction assigned by the originator of the instruction from the possible values: <ul style="list-style-type: none"> <input type="checkbox"/> High <input type="checkbox"/> Normal <input type="checkbox"/> Reserved <input type="checkbox"/> Top
Restriction Reference	Shows the identification of the restriction assigned by T2S.
Restriction Type Balance from	Shows the restriction type code of a balance of a T2S DCA/position of a debited securities account. The code is defined by a CSD or the CB to identify the restriction.

General Statement Information	
Issuer	Shows the entity assigning the identification. The fixed value is 'T2S'.
Scheme Name	Shows the name of the scheme.
Restriction Type Balance to	Shows the restriction type code of a balance of a T2S DCA/position of a credited securities account. The code is defined by a CSD or the CB to identify the restriction.
Issuer	Shows the entity assigning the identification. The fixed value is 'T2S'.
Scheme Name	Shows the name of the scheme.
Settlement Parties	
Delivering Settlement Parties	
This subframe is optional and only available for settlement instruction information	
Delivering Depository	
Party BIC	Shows the BIC of the delivering depository.
Delivering CSD Participant	
Party BIC	Shows the BIC of the CSD participant delivering the securities.
Processing Identification	Shows the unambiguous identification of the transaction as assigned by the delivering party.
Client of the Delivering CSD Participant	
Specifying the party only via party BIC or its name or the triplet of identification, issuer and scheme name.	
Party BIC	Shows the BIC of the client of delivering CSD participant.
Identification	Shows the proprietary identification of the pre-mentioned party BIC.
Issuer	Shows the entity assigning the identification.
Scheme Name	Shows the name of the scheme.
Name	Shows the name of the client of delivering CSD participant.
Delivering Party 3	
Specifying the party only via party BIC or its name or the triplet of identification, issuer and scheme name.	
Party BIC	Shows the BIC of delivering party 3.

General Statement Information	
Identification	Shows the proprietary identification of the pre-mentioned party BIC.
Issuer	Shows the entity assigning the identification.
Scheme Name	Shows the name of the scheme.
Name	Shows the name of delivering party 3.
Delivering Party 4	
Specifying the party only via party BIC or its name or the triplet of identification, issuer and scheme name.	
Party BIC	Shows the BIC of delivering party 4.
Identification	Shows the proprietary identification of the pre-mentioned party BIC.
Issuer	Shows the entity assigning the identification.
Scheme Name	Shows the name of the scheme.
Name	Shows the name of delivering party 4.
Delivering Party 5	
Specifying the party only via party BIC or its name or the triplet of identification, issuer and scheme name.	
Party BIC	Shows the BIC of delivering party 5.
Identification	Shows the proprietary identification of the pre-mentioned party BIC.
Issuer	Shows the entity assigning the identification. The fixed value is 'T2S'.
Scheme Name	Shows the name of the scheme.
Name	Shows the name of delivering party 5.
Receiving Settlement Parties	
This subframe is optional and only available for settlement instruction information	
Receiving Depository	
Party BIC	Shows the BIC of the receiving depository.
Receiving CSD Participant	
Party BIC	Shows the BIC of the CSD receiving the securities.
Processing Identification	Shows the unambiguous identification of the transaction as assigned by the receiving party.
Client of the Receiving CSD Participant	

General Statement Information	
Specifying the party only via party BIC or its name or the triplet of identification, issuer and scheme name.	
Party BIC	Shows the BIC of the client of receiving CSD participant.
Identification	Shows the proprietary identification of the pre-mentioned party BIC.
Issuer	Shows the entity assigning the identification.
Scheme Name	Shows the name of the scheme.
Name	Shows the name of the client of receiving CSD participant.
Receiving Party 3	
Specifying the party only via party BIC or its name or the triplet of identification, issuer and scheme name.	
Party BIC	Shows the BIC of receiving party 3.
Identification	Shows the proprietary identification of the pre-mentioned party BIC.
Issuer	Shows the entity assigning the identification.
Scheme Name	Shows the name of the scheme.
Name	Shows the Name of receiving party 3.
Receiving Party 4	
Specifying the party only via party BIC or its name or the triplet of identification, issuer and scheme name.	
Party BIC	Shows the BIC of receiving party 4.
Identification	Shows the proprietary identification of the pre-mentioned party BIC.
Issuer	Shows the entity assigning the identification.
Scheme Name	Shows the name of the scheme.
Name	Shows the Name of receiving party 4.
Receiving Party 5	
Specifying the party only via party BIC or its name or the triplet of identification, issuer and scheme name.	
Party BIC	Shows the BIC of receiving party 5.
Identification	Shows the proprietary identification of the pre-mentioned party BIC.
Issuer	Shows the entity assigning the identification.
Scheme Name	Shows the name of the scheme.

General Statement Information	
Name	Shows the Name of receiving party 5.

2.4.1.14 Available Report - Statement of Pending Instructions - Details Screen

Context of Usage

This screen displays detailed information on pending instructions.

The report displayed in this screen has to be already created in accordance with its report configuration.

For large reports the user has the option view them in portions of up to 500 transactions. Only the current portion of the report will be available for a download or print.

This screen is not relevant for CB and payment bank/settlement bank users.

Screen Access

Services >> Additional Services >> Reports >> *Available reports – search/list* screen >> Click on the *details* button

Services >> Additional Services >> Reports >> *Available reports – search/list* screen >> Click on the *search* and/or *details* button >> *Available report – details* screen >> Click on the *details* button

Privileges

To use this screen, you need the following privilege [▶ 1202]:

Report details query

References

User Instructions Part

This screen is part of the following business scenario:

View available reports

Business Functionality Document

This screen corresponds to the following business function:

Display generated report details (T2S.GUI.INSE.RPT.0090)

Screenshot

The screenshot displays a web application interface with a top navigation bar containing tabs: SECURITIES, CASH, SERVICES, STATIC DATA, and MONITORING. Below the navigation bar, a breadcrumb trail reads: Services > Additional Services > Reports > Report Details > Statement of Pending Instructions. The main content area is divided into two sections:

- General Information:** A table with three columns. Fields include Report Name (Statement of Pending Instructions), Delta Mode (No), Statement Number (20210408PF001157), Report Number (100002662), Frequency (DAIL), Scheduled (12.00), Activity Indicator (True), Covered Period from (2021-04-07 11:12:28), Covered Period to (2021-04-07 12:00:00), Report Owner BIC (CSDGNLA0XXX), Report Owner Parent BIC (TCSOTCS0XXX), System Entity Wide Report (Yes), Securities Account Number (ISSACGNL0001), Securities Account Owner BIC (CSDGNLA0XXX), and Securities Account Servicer BIC (TCSOTCS0XXX).
- Pending Settlement Instruction 1 of 1:** A detailed table with three columns. Fields include Account Owner Reference (NONREF), Account Servicer Reference (SI0001), Third Party Reference (---), Settlement Instruction Technical Identifier (2104070502627263), Pool Instruction Reference (---), Common Reference (---), Trade Date (2021-04-07), Intended Settlement Date (2021-04-07), Movement Type Code (DELI), Payment Type (FREE), ISIN (NLCGNL000012), Name (CSDGNLA0XXX as NLCGNL000012), Remaining Quantity (100), Settlement Type (UNIT), Remaining Amount (---), Credit Debit Indicator (---), Settlement Currency (---), Place of Trade Market Type Proprietary Issuer (---), Place of Trade MIC (---), Place of Trade Description (---), Place of Trade Market Type Code (---), Place of Trade Market Type Proprietary Id (---), Place of Trade Market Type Proprietary Scheme Name (---), Place of Clearing (---), Transaction Activity Code (SETT), Delivering Settlement Parties (CSDGNLA0XXX), Processing Identification (---), Delivering T2S Party (CSDGNLA0XXX), Delivering Party - Securities Account (ISSACGNL0001), Processing Identification (---), Proprietary Identification (---), Issuer (---), Schema Name (---), Name and Address (---), Processing Identification (---), Receiving Settlement Parties (CSDGNLA0XXX), Processing Identification (---), Receiving T2S Party (PMBGNLA0XXX), Receiving Party - Securities Account (CSDPCGNL0002), Processing Identification (---), Proprietary Identification (---), Issuer (---), Schema Name (---), Name and Address (---), Processing Identification (---), Further Information (---), Settlement Transaction Condition Indicator (---), Partial Settlement Indicator (---), Corporate Action Event Identification (---), CSD Hold Status (false), CoSD Hold Status (false), CoSD Rule Identification (---), Validation Hold Status (false), Party Hold Status (false), Status Information (---), Matching Status (false), Settlement Status (---), Accepted Timestamp (SF1) (2021-04-07T10:28:16.74410Z), Matched Timestamp (SF2) (---), ISO Settlement-Status (Failing), Reason Code (CYCL), Reason Code Additional Information (AwaitingNextSettlementCycle), Cancellation Requested (No), Acknowledgement Status (---), Cancellation Status (Not Cancelled), Pending Cancellation Status (---), Reason Code (---), Reason Code Additional Information (---).

A 'Cancel' button is located at the bottom left of the screen.

Illustration 106: Available report - statement of pending instructions - details screen

Field Description

General Statement Information	
Report Name	Shows the name of the report.
Delta Mode	Shows if the report is a delta report or not. Possible values are: <input type="checkbox"/> Yes

General Statement Information	
	<input type="checkbox"/> No
Statement Number	Shows the statement number of the report composed of the business date and report type (2-letter abbreviation depending on report type and delta/full-flag) and the sequential number, which is unique in T2S. The number increases for each report.
Report Number	Shows the sequential number of the report which is specific for a report receiving party. This number will only be displayed if the sending user belongs to a report receiving party.
Frequency	Shows the frequency of the report from the possible value: <input type="checkbox"/> DAILY (for reports created on a daily basis)
Scheduled	Shows the name of the business event or time triggering the report creation.
Activity Indicator	Shows whether the report displays activities or only lists information from the possible values: <input type="checkbox"/> True <input type="checkbox"/> False
Covered Period from	Shows the date and time from which the data are covered in the report. Displayed format is: YYYY-MM-DD hh:mm:ss
Covered Period to	Shows the date and time until which the data are covered in the report. Displayed format is: YYYY-MM-DD hh:mm:ss
Report Owner BIC	Shows the BIC of the party whose data are reported.
Report Owner Parent BIC	Shows the parent BIC of the party whose data are reported.
System Entity Wide Report	Shows whether the report is a community report (covering all information referring to a system entity) or a party based report (covering all information referring to a party) from the possible values: <input type="checkbox"/> Yes <input type="checkbox"/> No
Securities Account Information	

General Statement Information	
Securities Account Number	Shows the number of the securities account on which the report is based.
Securities Account Owner BIC	Shows the BIC of the party owning the securities account.
Securities Account Servicer BIC	Shows the BIC of the party operating the securities account.
Transaction	
Repetitive Block For Each Pending Settlement Instruction	
Statement - Instruction References	
Account Owner Reference	Shows the identification of the instruction assigned by the delivering/receiving party.
Account Servicer Reference	Shows the identification of an instruction as assigned by the CSD.
Third Party Reference	Shows the identification of the instruction assigned by a third party.
Settlement Instruction Technical Identifier	Shows the identification of a settlement instruction as assigned by T2S.
Pool Instruction Reference	Shows the identification of a pool of settlement instructions or settlement restrictions.
Common Reference	Shows the identification the 2 trade counterparties agreed in order to identify the trade. This field is optional.
Statement - Trade Timeline	
Trade Date	Shows the date when the contract was made. Displayed format is: YYYY-MM-DD
Intended Settlement Date	Shows the date when the instruction is forwarded to settlement for the first time. Displayed format is: YYYY-MM-DD
Statement - Trade Information	
Movement Type Code	Shows the movement on a securities account from the possible values: <input type="checkbox"/> Delivery <input type="checkbox"/> Receive
Payment Type	Shows the type of the payment from the possible values: <input type="checkbox"/> APMT (for against payment settlement)

General Statement Information	
	<input type="checkbox"/> FREE (for separate settlement)
ISIN	Shows the ISIN of the security.
Name	Shows the name of the party whose data are reported.
Remaining Quantity	Shows the quantity of securities to be settled. It shows the result of original settlement quantity deducting the settled settlement quantity.
Settlement Type	Shows the type of settlement from the possible values: <input type="checkbox"/> UNIT (Units) <input type="checkbox"/> FAMT (Face Amount)
Remaining Amount	Shows the amount to be settled. It shows the result of original/matched settlement amount deducting the settled settlement amount.
Debit Credit Indicator	Shows if an operation is a credit or a debit from the possible values: <input type="checkbox"/> CRDT (for credit) <input type="checkbox"/> DBIT (for debit)
Settlement Currency	Shows the currency of the settlement.
Place of Trade Market Identifier Code	Shows the identification of a financial market, as stipulated in the norm ISO 10383:2012 "Codes for exchanges and market identifications".
Place of Trade Description	Shows the description of the market when no Market Identifier Code is available.
Place of Trade Market Type Code	Shows the market type expressed as an ISO 20022 code.
Place of Trade Market Type Proprietary Identification	Shows the proprietary information, often a code, issued by the data source scheme issuer.
Place of Trade Market Type Proprietary Issuer	Shows the entity that assigns the identification.
Place of Trade Market Type Proprietary Scheme Name	Shows a short textual description of the scheme.
Place of Clearing	Shows the BIC code of the Clearing House involved in the settlement (if any).

General Statement Information	
Transaction Activity Code	Specifies the type of activity to which this instruction relates: <ul style="list-style-type: none"> <input type="checkbox"/> BOLE: Borrowing and Lending Activity; <input type="checkbox"/> CLAI: Market Claim; <input type="checkbox"/> COLL: Collateral Activity; <input type="checkbox"/> CORP: Corporate Action Activity; <input type="checkbox"/> SETT: Settlement and Clearing Activity
Settlement Parties	
Delivering Settlement Parties	
This subframe is optional and only available for settlement instruction information	
Delivering Depository	
Party BIC	Shows the BIC of the delivering depository.
Processing Identification	Shows the unambiguous identification of the transaction as assigned by the delivering depository.
Settlement Instruction Information – Settlement Parties – Delivering Settlement Parties – Delivering CSD Participant	
Party BIC	Shows the BIC of the CSD participant delivering the securities.
Securities Account Number	Shows the securities account number of the delivering CSD participant.
Processing Identification	Shows the unambiguous identification of the transaction as assigned by the delivering CSD participant.
Client of the Delivering CSD Participant	
Specifying the party only via party BIC or its name or the triplet of identification, issuer and scheme name.	
Party BIC	Shows the BIC of the client of delivering CSD participant.
Identification	Shows the proprietary identification of the pre-mentioned party BIC.
Issuer	Shows the entity assigning the identification.
Scheme Name	Shows the name of the scheme.
Name	Shows the name of the client of delivering CSD participant.
Processing Identification	Shows the unambiguous identification of the transaction as assigned by the client of delivering CSD participant.

General Statement Information	
Receiving Settlement Parties	
This subframe is optional and only available for settlement instruction information	
Receiving Depository	
Party BIC	Shows the BIC of the receiving depository.
Processing Identification	Shows the unambiguous identification of the transaction as assigned by the receiving depository.
Receiving CSD Participant	
Party BIC	Shows the BIC of the CSD receiving the securities.
Securities Account Number	Shows the securities account number of the receiving CSD participant.
Processing Identification	Shows the unambiguous identification of the transaction as assigned by the receiving CSD participant.
Client of the Receiving CSD Participant	
Specifying the party only via party BIC or its name or the triplet of identification, issuer and scheme name.	
Party BIC	Shows the BIC of the client of receiving CSD participant.
Identification	Shows the proprietary identification of the pre-mentioned party BIC.
Issuer	Shows the entity assigning the identification.
Scheme Name	Shows the name of the scheme.
Name	Shows the name of the client of receiving CSD participant.
Process Identification	Shows the unambiguous identification of the transaction as assigned by the client of receiving CSD participant.
Statement - Further Information	
ISO Transaction Code	Shows the transaction code as defined in ISO20022
Settlement Transaction Condition Indicator	Shows the Settlement Transaction Condition Indicator. This field can show multiple Settlement Transaction Condition Indicators.
Partial Settlement Indicator	Shows if the settlement instruction is allowed to be subject to partial settlement from the possible values: <ul style="list-style-type: none"> <input type="checkbox"/> NPAR (for no partial settlement allowed) <input type="checkbox"/> PART (for partial settlement allowed without restrictions)

General Statement Information	
	<input type="checkbox"/> PARC (for partial settlement allowed but the settlement amount must not be below the threshold) <input type="checkbox"/> PARQ (for partial settlement allowed but the quantity must not be below the threshold)
Corporate Action Event Identification	Shows the identification of the instruction assigned by the account servicer to identify a corporate action event.
CSD Hold Status	Shows the hold status as set by the CSD from the possible values: <input type="checkbox"/> Yes <input type="checkbox"/> No (default value)
CoSD Hold Status	Shows whether the settlement instruction fulfills 1 CoSD rule configured in reference data from the possible values: <input type="checkbox"/> Yes <input type="checkbox"/> No (default value)
CoSD Rule Identification	Shows the identification of the respective CoSD rule.
CSD Validation Hold Status	Shows whether the settlement instruction fulfills 1 market-specific restriction configured in reference data from the possible values: <input type="checkbox"/> Yes <input type="checkbox"/> No
Party Hold Status	Shows the hold status as set by the T2S party from the possible values: <input type="checkbox"/> Yes <input type="checkbox"/> No
Status Information	
Matching status	Shows the matching status of the (cancellation) instruction from the possible values: <input type="checkbox"/> MACH (matched) <input type="checkbox"/> NMAT (unmatched)
Accepted Timestamp (SF1)	Shows the accepted timestamp of the settlement instruction. Displayed format is: YYYY-MM-DD hh:mm:ss:µsµsµsµsµs
Matched Timestamp (SF2)	Shows the matched timestamp of the settlement instruction.

General Statement Information	
	<p>In case the settlement instruction is unmatched no timestamp will be shown.</p> <p>Displayed format is: YYYY-MM-DD hh:mm:ss:μsμsμsμsμs</p>
Settlement Status	<p>Shows the status of the settlement instruction from the possible values:</p> <ul style="list-style-type: none"> <input type="checkbox"/> USET (for unsettled) <input type="checkbox"/> PSET (for partially settled)
ISO Settlement Status	<p>Shows the ISO settlement status of the settlement instruction from the possible values:</p> <ul style="list-style-type: none"> <input type="checkbox"/> Pending <input type="checkbox"/> Failing
Settlement Status Reason Code	Shows the reason code why an instruction has a certain settlement status.
Settlement Status Reason Code Additional Information	Shows additional information on the reason code.
Cancellation Requested	<p>Shows whether a cancellation was requested from the counterparty for this transaction from the possible values:</p> <ul style="list-style-type: none"> <input type="checkbox"/> Yes <input type="checkbox"/> No
Acknowledged Accepted	<p>Shows whether the account servicer acknowledged the instruction from the possible values:</p> <ul style="list-style-type: none"> <input type="checkbox"/> Yes <input type="checkbox"/> No
Cancellation Status	<p>Shows the current cancellation status of the instruction from the possible values:</p> <ul style="list-style-type: none"> <input type="checkbox"/> Cancelled <input type="checkbox"/> Not cancelled
Pending Cancellation Status	<p>Shows the status of the instruction from the possible values:</p> <ul style="list-style-type: none"> <input type="checkbox"/> CANC (for cancelled) <input type="checkbox"/> NCAN (for not cancelled)
Pending Cancellation Status Reason Code	Shows the reason for the pending status.

General Statement Information	
Pending Cancellation Status – Reason Code Additional Information	Shows additional information on the reason code.

2.4.1.15 Available Report - Statement of Pending Intra-Balance Movements - Details Screen

Context of Usage

This screen displays detailed information on pending intra-balance movements.

The report displayed in this screen has to be already created in accordance with its report configuration.

This screen is not relevant for CSD, external CSD and CSD participant users.

Screen Access

Services >> Additional Services >> Reports >> *Available reports – search/list* screen >> Click on the *details* button

Services >> Additional Services >> Reports >> *Available reports – search/list* screen >> Click on the *search* and/or *details* button >> *Available report – details* screen >> Click on the *details* button

Privileges

To use this screen, you need the following privilege [ 1202]:

Report details query

References

User Instructions Part

This screen is part of the following business scenario:

View available reports

Business Functionality Document

This screen corresponds to the following business function:

Display generated report details (T2S.GUI.INSE.RPT.0090)

Screenshot

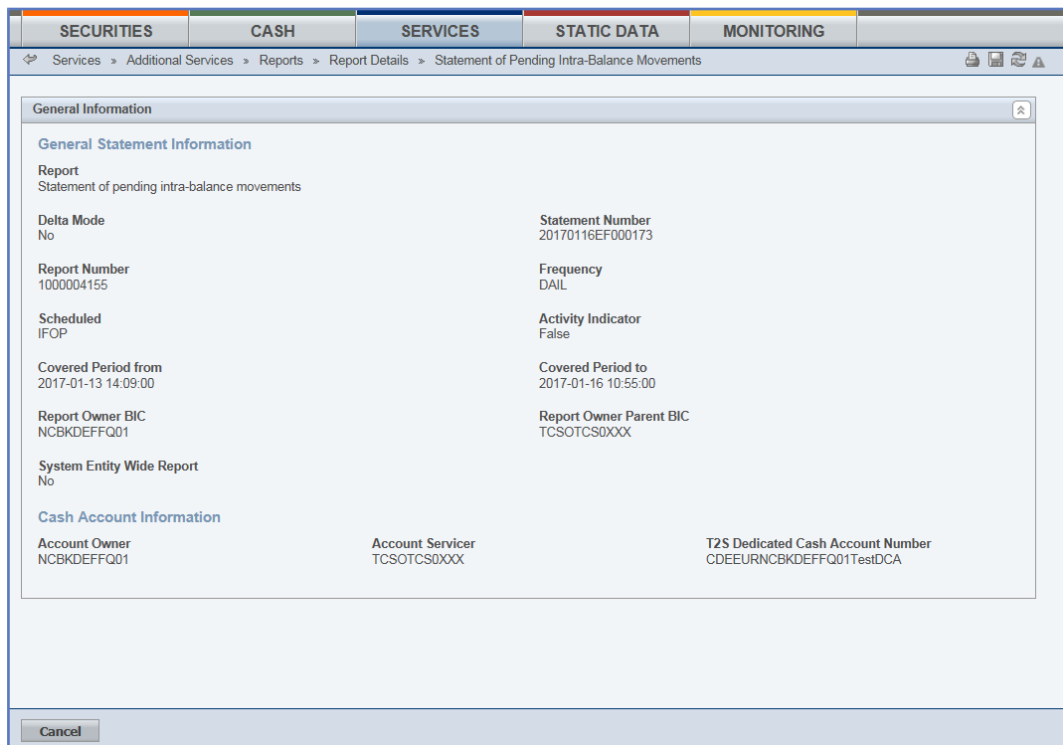

Illustration 107: Available report – statement of pending intra-balance movements – details screen

Field

Description

General Statement Information	
Report Name	Shows the name of the report.
Delta Mode	Shows if the report is a delta report or not. Possible values are: <input type="checkbox"/> Yes <input type="checkbox"/> No
Statement Number	Shows the statement number of the report composed of the business date and report type (2-letter abbreviation depending on report type and Delta/Full-Flag) and the sequential number, which is unique in T2S. The number increases for each report.
Report Number	Shows the sequential number of the report which is specific for a report receiving party. This number will only be displayed if the sending user belongs to a report receiving party.
Frequency	Shows the frequency of the report, which is always 'DAILY'.
Scheduled	Shows the name of the business event or time triggering the report creation.

General Statement Information	
Activity Indicator	Shows whether the report displays activities or only lists information from the possible values: <input type="checkbox"/> True <input type="checkbox"/> False
Covered Period From	Shows the date and time from which the data are covered in the report. Displayed format is: YYYY-MM-DD hh:mm:ss
Covered Period To	Shows the date and time until which the data are covered in the report. Displayed format is: YYYY-MM-DD hh:mm:ss
Report Owner BIC	Shows the BIC of the party whose data are reported.
Report Owner Parent BIC	Shows the parent BIC of the party whose data are reported.
System Entity Wide Report	Shows whether the report is a community report (covering all information referring to a system entity) or a party based report (covering all information referring to a party). from the possible values: <input type="checkbox"/> Yes <input type="checkbox"/> No
Cash Account Information	
T2S Dedicated Cash Account Owner BIC	Shows the BIC of the party owning the T2S dedicated cash account.
T2S Dedicated Cash Account Owner Parent BIC	Shows the parent BIC of the party owning the dedicated cash account.
T2S Dedicated Cash Account Number	Shows the T2S dedicated cash account for which the report is created.
Intra-Balance Movement Information	
Repetitive Block For Each Intra-Balance Movement	
Intra-Balance Movement Information	
Settlement Status	Shows the settlement status of the instruction from the possible values: <input type="checkbox"/> USET (for unsettled) (default value) <input type="checkbox"/> SETT (for settled) <input type="checkbox"/> PSET (for partially settled)

General Statement Information	
ISO Settlement Status	Shows the ISO settlement status of the settlement restriction from the possible values: <input type="checkbox"/> Pending <input type="checkbox"/> Failing
Settlement Status Reason Code	Shows the reason code why an instruction has a certain settlement status.
Settlement Status Reason Information	Shows additional settlement status information.
Cancellation Status	Shows the status of the instruction from the possible values: <input type="checkbox"/> DEND (for denied) <input type="checkbox"/> NDEN (for not denied)
Cancellation Status Reason Code	Shows the reason code for the cancellation.
Cancellation Status Additional Information	Shows additional information on the cancellation status.
Last Update of Status	Shows the date and time of the last status update. Displayed format is: YYYY-MM-DD hh:mm:ss:µsµsµsµsµs
References	
Intra-Balance Movement Technical Identifier	Shows the unique technical identification of the intra-balance movement assigned by T2S.
Account Owner Reference	Shows the reference of the instruction which is assigned by the T2S delivering/receiving party.
Account Servicer Reference	Shows the reference of the instruction assigned by the account referencer.
Third Party Reference	Shows the identification of the instruction assigned by a third party.
Pool Instruction Reference	Shows the identification of a pool of settlement instructions or settlement restrictions.
Restriction Reference	Shows the identification of the restriction assigned by T2S.
Settlement Information	

General Statement Information	
Restriction Type Balance from	Shows the restriction type code of a balance of a T2S dedicated cash account which is debited.
Restriction Type Balance to	Shows the restriction type code of a balance of a T2S dedicated cash account which is credited.
Currency	Shows the currency code.
Original Settlement Amount	Shows the amount as stated in the settlement instruction.
Intended Settlement Date	Shows the date when the instruction is forwarded to settlement for the first time. Displayed format is: YYYY-MM-DD
Priority	Shows the priority of the payment instruction assigned by the originator of the instruction from the possible values: <input type="checkbox"/> High <input type="checkbox"/> Normal <input type="checkbox"/> Reserved <input type="checkbox"/> Top
Instruction Link Information	
Link Type	Shows the link type of the instruction from the possible values: <input type="checkbox"/> Afte (Instruction has to be settled after or at the same time as the linked instruction) <input type="checkbox"/> Befo (Instruction has to be settled before or at the same time as the linked instruction) <input type="checkbox"/> With (Instruction has to be settled at the same time as the linked instruction) <input type="checkbox"/> Info (Specifies that the instructions are linked for information purposes only)
Message Number	Shows the identification of the message referenced in the linked sequence.
Linked Instruction Reference of a Party	Shows the T2S actor reference of the LCMM instruction linked to the relevant LCMM instruction. In case a link between 2 or more LCMM instructions exists, the ISO settlement link indicators <input type="checkbox"/> After <input type="checkbox"/> Before

General Statement Information	
	<input type="checkbox"/> All-or-none <input type="checkbox"/> are used.
Linked Instruction T2S Technical Identifier	Shows the technical identification of the linked instruction.
Received Account Owner BIC	BIC of the T2S party owner of the reference of the instruction/pool which this instruction is linked to.
Pool Instruction Reference	Shows the identification of a pool of settlement instructions or settlement restrictions.
Instructing Party	
Instructing Party BIC	Shows the BIC of the instructing party.
Instructing Party Parent BIC	Shows the parent BIC of the instructing party.
Entry Date and Time	Shows the entry date and time of an instruction. Displayed format: YYYY-MM-DD hh:mm:ss

2.4.1.16 Available Report - Statement of Pending Intra-Position Movements - Details Screen

Context of Usage	<p>This screen displays detailed information on the selected statement of pending intra-position movements. The displayed report in this screen has to be already created in accordance with its report configuration.</p> <p>This screen is not relevant for CB and payment bank/settlement bank users.</p>
Screen Access	<ul style="list-style-type: none"> <input type="checkbox"/> Services >> Additional Services >> Reports >> <i>Available reports – search/list</i> screen >> Click on the <i>details</i> button <input type="checkbox"/> Services >> Additional Services >> Reports >> <i>Available reports – search/list</i> screen >> Click on the <i>search</i> and/or <i>details</i> button >> <i>Available report – details</i> screen >> Click on the <i>details</i> button
Privileges	<p>To use this screen, you need the following privilege [▶ 1203]:</p> <ul style="list-style-type: none"> <input type="checkbox"/> Report details query
References	<p>User Instructions Part</p> <p>This screen is part of the following business scenario:</p> <ul style="list-style-type: none"> <input type="checkbox"/> View available reports <p>Business Functionality Document</p> <p>This screen corresponds to the following business function:</p> <ul style="list-style-type: none"> <input type="checkbox"/> Display generated report details (T2S.GUI.INSE.RPT.0090)

Screenshot

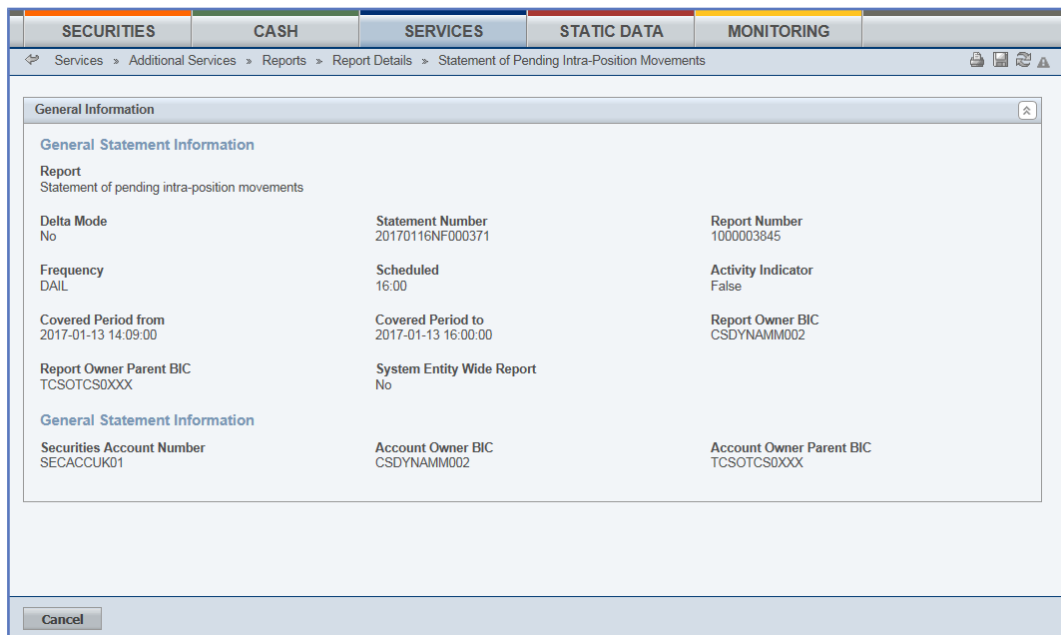

Illustration 108: Available report - statement of pending intra-position movements - details screen

Field

Description

General Statement Information	
Report Name	Shows the name of the report.
Delta Mode	Shows if the report is a delta report or not. Possible values are: <input type="checkbox"/> Yes <input type="checkbox"/> No
Statement Number	Shows the statement number of the report composed of the business date and report type (2-letter abbreviation depending on report type and delta/full-flag) and the sequential number, which is unique in T2S. The number increases for each report.
Report Number	Shows the sequential number of the report which is specific for a report receiving party. This number will only be displayed if the sending user belongs to a report receiving party.
Scheduled	Shows the name of the business event or time triggering the report creation.
Frequency	Shows the frequency of the report from the possible value: <input type="checkbox"/> DAILY (for reports created on a daily basis)
Activity Indicator	Shows whether the report displays activities or only lists information from the possible values: <input type="checkbox"/> True

General Statement Information	
	<input type="checkbox"/> False
Covered Period from	Shows the date and time from which the data are covered in the report. Displayed format is: YYYY-MM-DD hh:mm:ss
Covered Period to	Shows the date and time until which the data are covered in the report. Displayed format is: YYYY-MM-DD hh:mm:ss
Report Owner BIC	Shows the BIC of the party whose data are reported.
Report Owner Parent BIC	Shows the parent BIC of the party whose data are reported.
System Entity Wide Report	Shows whether the report is a community report (covering all information referring to a system entity) or a party based report (covering all information referring to a party) from the possible values: <input type="checkbox"/> Yes <input type="checkbox"/> No
General Information	
Securities Account Number	Shows the number of the securities account.
Account Owner BIC	Shows the BIC of the party which owns the securities account.
Account Owner Parent BIC	Shows the parent BIC of the party.
Intra-Position Movement Information	
Repetitive Block For Each Intra-Position Movement	
Intra-Position Movement References	
Account Owner Reference	Shows the identification of the instruction assigned by the T2S delivering/receiving party.
Account Servicer Reference	Shows the identification of the transaction assigned by the CSD.
Third Party Reference	Shows the identification of the instruction assigned by a third party.
Intra-Position Movement Reference	Shows the identification of the instruction assigned by the T2S system.
Pool Identification	Shows the grouped LCMM instructions.

General Statement Information	
Intra-Position Movement Details	
Instructing Party BIC	Shows the BIC of the instructing party.
Instructing Party Parent BIC	Shows the parent BIC of the instructing party.
Entry Date and Time	Shows the date and time when the instruction entered T2S. Displayed format is: YYYY-MM-DD hh:mm:ss
Intended Settlement Date	Shows the date when the instruction is forwarded to settlement for the first time. Displayed format is: YYYY-MM-DD
Priority	Shows the priority of the payment instruction assigned by the originator of the instruction from the possible values: <ul style="list-style-type: none"> <input type="checkbox"/> High <input type="checkbox"/> Normal <input type="checkbox"/> Reserved <input type="checkbox"/> Top
ISIN	Shows the ISIN of the security.
Settlement Type	Shows the type of settlement from the possible values: <ul style="list-style-type: none"> <input type="checkbox"/> UNIT (Units) <input type="checkbox"/> FAMT (Face Amount)
Original Settlement Quantity	Shows the quantity of securities to be settled.
Restriction Type Balance from	Shows the restriction type code of a position of a debited securities account.
Issuer	Shows the entity assigning the identification. The fixed value is 'T2S'.
Scheme Name	Shows the name of the scheme.
Restriction Type Balance to	Shows the securities position to be credited.
Issuer	Shows the entity assigning the identification. The fixed value is 'T2S'.
Scheme Name	Shows the name of the scheme.

General Statement Information	
Restriction Reference	Shows the identification of the restriction assigned by T2S.
Status Information	
Last Update of Status	Shows the date and time of the last status update. Displayed format is: YYYY-MM-DD hh:mm:ss
Accepted Timestamp (SF1)	Shows the accepted timestamp of the settlement restriction. Displayed format is: YYYY-MM-DD hh:mm:ss:µsµsµsµsµs
Settlement Status	Shows the settlement status of the instruction from the possible values: <input type="checkbox"/> USET (for unsettled) <input type="checkbox"/> SETT (for settled) <input type="checkbox"/> PSET (for partially settled)
ISO Settlement Status	Shows the ISO settlement status of the settlement restriction from the possible values: <input type="checkbox"/> Pending <input type="checkbox"/> Failing
Reason Code	Shows the code of the reason why the instruction has a certain settlement status according to ISO20022.
Reason Code Description	Shows the detailed description of the reason code.
Cancellation Status	Shows the status of the instruction from the possible values: <input type="checkbox"/> Cancelled <input type="checkbox"/> Not Cancelled
Reason Code	Shows the code of the reason why the related instruction has a certain settlement status according to ISO20022.
Reason Code Description	Shows the detailed description of the reason code.
Link Information	
Link Type	Shows the link type of the instruction from the possible values: <input type="checkbox"/> Afte (instruction has to be settled after or at the same time as the linked instruction)

General Statement Information	
	<input type="checkbox"/> Befo (instruction has to be settled before or at the same time as the linked instruction) <input type="checkbox"/> With (instruction has to be settled at the same time as the linked instruction) <input type="checkbox"/> Info (specifies that the instructions are linked for information purposes only)
Message Number	Shows the identification of the message referenced in the linked sequence.
T2S Instruction Reference	Shows the T2S technical identification of the linked instructions.
T2S Actor Instruction Reference	Shows the identification of the instruction assigned by the T2S actor.
Pool Identification	Shows the grouped LCMM instructions.
Received Account Owner BIC	Shows the BIC of the T2S party owner of the referenced instruction/pool which the instruction is linked to.

2.4.1.17 Available Report - Statement of Settled Intra-Balance Movements - Details Screen

Context of Usage	<p>This screen displays detailed information on the selected statement of settled intra-balance movements. The report displayed in this screen has to be already created in accordance with its report configuration.</p> <p>This screen is not relevant for CSD, external CSD and CSD participant users.</p>
Screen Access	<ul style="list-style-type: none"> <input type="checkbox"/> Services >> Additional Services >> Reports >> <i>Available reports – search/list</i> screen >> Click on the <i>details</i> button <input type="checkbox"/> Services >> Additional Services >> Reports >> <i>Available reports – search/list</i> screen >> Click on the <i>search</i> and/or <i>details</i> button >> <i>Available report – details</i> screen >> Click on the <i>details</i> button
Privileges	<p>To use this screen, you need the following privilege [▶ 1203]:</p> <ul style="list-style-type: none"> <input type="checkbox"/> Report details query
References	<p>User Instructions Part</p> <p>This screen is part of the following business scenario:</p> <ul style="list-style-type: none"> <input type="checkbox"/> View available reports <p>Business Functionality Document</p> <p>This screen corresponds to the following business function:</p> <ul style="list-style-type: none"> <input type="checkbox"/> Display generated report details (T2S.GUI.INSE.RPT.0090)

Screenshot

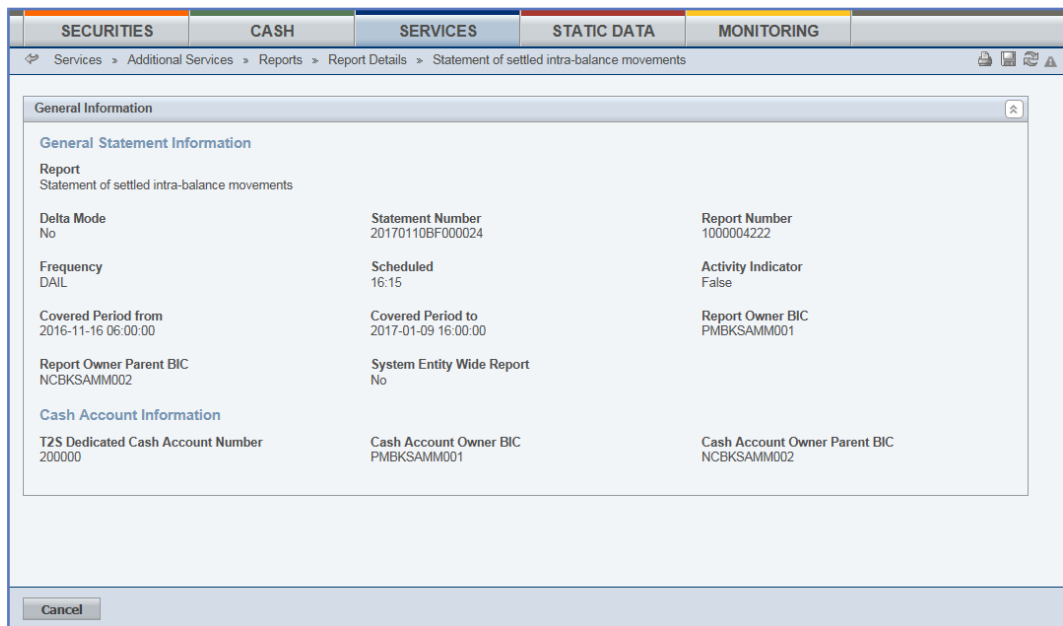

Illustration 109: Available report - statement of settled intra-balance movements - details screen

Field

Description

General Statement Information	
Report Name	Shows the name of the report.
Delta Mode	Shows if the report is a delta report or not. Possible values are: <input type="checkbox"/> Yes <input type="checkbox"/> No
Statement Number	Shows the statement number of the report composed of the business date and report type (2-letter abbreviation depending on report type and Delta/Full-Flag) and the sequential number, which is unique in T2S. The number increases for each report.
Report Number	Shows the sequential number of the report which is specific for a report receiving party. This number will only be displayed if the sending user belongs to a report receiving party.
Scheduled	Shows the name of the business event or time triggering the report creation.
Frequency	Shows the frequency of the report, which is always 'DAILY'.
Activity Indicator	Shows whether the report displays activities or only lists information from the possible values: <input type="checkbox"/> True

General Statement Information	
	<input type="checkbox"/> False
Covered Period From	Shows the date and time from which the data are covered in the report. Displayed format is: YYYY-MM-DD hh:mm:ss
Covered Period to	Shows the date and time until which the data are covered in the report. Displayed format is: YYYY-MM-DD hh:mm:ss
Report Owner BIC	Shows the BIC of the party whose data are reported.
Report Owner Parent BIC	Shows the parent BIC of the party whose data are reported.
System Entity Wide Report	Shows whether the report is a community report (covering all information referring to a system entity) or a party based report (covering all information referring to a party). from the possible values: <input type="checkbox"/> Yes <input type="checkbox"/> No
Intra-Balance Movement Information Repetitive Block for each Intra-Balance Movement	
Cash Account Information	
T2S Dedicated Cash Account Number	Shows the T2S dedicated cash account for which the report is created.
T2S Dedicated Cash Account Owner BIC	Shows the BIC of the party owning the T2S dedicated cash account.
T2S Dedicated Cash Account Owner Parent BIC	Shows the parent BIC of the party owning the dedicated cash account.
Intra-Balance Movement - References	
Intra-Balance Movement Technical Identifier	Shows the unique technical identification of the intra-balance movement assigned by T2S.
Actor Reference	Shows the identification of the instruction assigned by the T2S actor.

General Statement Information	
Account Owner Reference	Shows the identification of the instruction assigned by the T2S delivering/receiving party.
Account Servicer Reference	Shows the identification of the instruction assigned by the account servicer.
Third Party Reference	Shows the identification of the instruction assigned by a third party.
Pool Instruction Reference	Shows the identification of a pool of settlement instructions or settlement restrictions.
Restriction Reference	Shows the identification of the restriction assigned by T2S.
Intra-Balance Movement – Settlement Information	
Currency	Shows the currency code.
Settled Settlement Amount in the last status update	Shows the amount which was settled in the last status update.
Settled Settlement Amount	Shows the total settled amount.
Remaining Settlement Amount	Shows the settlement amount remaining still to be settled.
Actual Settlement Date	Shows the date of the settlement. Displayed format is: YYYY-MM-DD
Last Update of Status	Shows the date and time of the last status update. Displayed format is: YYYY-MM-DD hh:mm:ss:µsµsµsµsµs
Restriction Type Balance from	Shows the restriction type code of a balance of a T2S dedicated cash account which is debited.
Restriction Type Balance to	Shows the restriction type code of a balance of a T2S dedicated cash account which is credited.
Priority	Shows the priority of the payment instruction assigned by the originator of the instruction from the possible values: <ul style="list-style-type: none"> <input type="checkbox"/> High <input type="checkbox"/> Normal <input type="checkbox"/> Reserved <input type="checkbox"/> Top
Intra-Balance Movement – Instructing Party	

General Statement Information	
Instructing Party BIC	Shows the BIC of the instructing party.
Instructing Party Parent BIC	Shows the parent BIC of the instructing party.
Entry Date and Time	Shows the date and time when the instructions entered in T2S. Displayed format is: YYYY-MM-DD hh:mm:ss
Intra-Balance Movement - Status	
Settlement Status	Shows the settlement status of the instruction from the possible values: <input type="checkbox"/> SETT (for settled) <input type="checkbox"/> PSET (for partially settled)
Intra-Balance Movement – Instruction Link Information	
Repetitive Block for each Intra-Balance Movement with Link Information	
Link Type	Shows the link type of the instruction from the possible values: <input type="checkbox"/> Afte (Instruction has to be settled after or at the same time as the linked instruction) <input type="checkbox"/> Befo (Instruction has to be settled before or at the same time as the linked instruction) <input type="checkbox"/> With (Instruction has to be settled at the same time as the linked instruction) <input type="checkbox"/> Info (Specifies that the instructions are linked for information purposes only)
Message Number	Shows the identification of the message referenced in the linked sequence.
Linked Instruction Reference of Party	Shows the T2S actor reference of the LCMM instruction linked to the relevant LCMM instruction. In case a link between 2 or more LCMM instructions exists, the ISO settlement link indicators are shown from the possible values: <input type="checkbox"/> After <input type="checkbox"/> Before <input type="checkbox"/> All-or-none

General Statement Information	
Linked Instruction T2S Technical Identifier	Shows the technical identification of the linked instruction.
Pool Instruction Reference	Shows the identification of a pool of settlement instructions or settlement restrictions.
Received Account Owner BIC	Shows the BIC of the T2S party owner of the reference of the instruction/pool which this instruction is linked to.

2.4.1.18 Available Report - Statement of Settled Intra-Position Movements - Details Screen

Context of Usage	<p>This screen displays detailed information on the selected statement of settled intra-position movements. The report displayed in this screen has to be already created in accordance with its report configuration.</p> <p>This screen is not relevant for CB and payment bank/settlement bank users.</p>
Screen Access	<ul style="list-style-type: none"> <input type="checkbox"/> Services >> Additional Services >> Reports >> <i>Available reports – search/list</i> screen >> Click on the <i>search</i> and/or <i>details</i> button <input type="checkbox"/> Services >> Additional Services >> Reports >> <i>Available reports – search/list</i> screen >> Click on the <i>search</i> and/or <i>details</i> button >> <i>Available report – details</i> screen >> Click on the <i>details</i> button
Privileges	<p>To use this screen, you need the following privilege [▶ 1203]:</p> <ul style="list-style-type: none"> <input type="checkbox"/> Report details query
References	<p>User Instructions Part</p> <p>This screen is part of the following business scenario:</p> <ul style="list-style-type: none"> <input type="checkbox"/> View available reports <p>Business Functionality Document</p> <p>This screen corresponds to the following business function:</p> <ul style="list-style-type: none"> <input type="checkbox"/> Display generated reports list (T2S.GUI.INSE.RPT.0090)

Screenshot

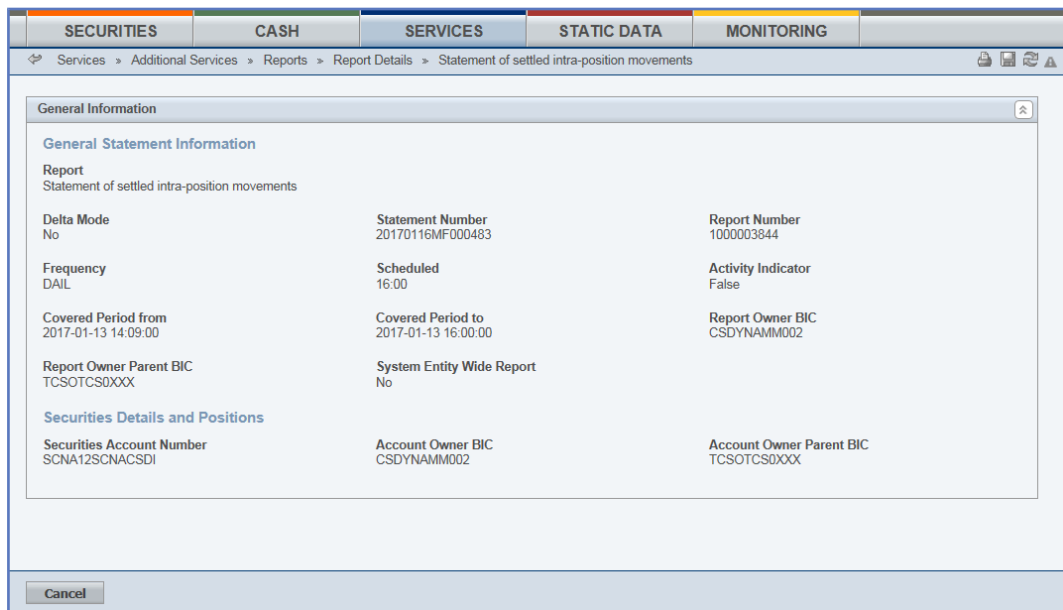

Illustration 110: Available report – statement of settled intra-position movements – details screen

Field

Description

General Statement Information	
Report Name	Shows the name of the report.
Delta Mode	Shows if the report is a delta report or not. Possible values are: <input type="checkbox"/> Yes <input type="checkbox"/> No
Statement Number	Shows the statement number of the report composed of the business date and report type (2-letter abbreviation depending on report type and delta/full-flag) and the sequential number, which is unique in T2S. The number increases for each report.
Report Number	Shows the sequential number of the report which is specific for a report receiving party. This number will only be displayed if the pending user belongs to a report receiving party.
Scheduled	Shows the name of the business event or time triggering the report creation.
Frequency	Shows the frequency of the report from the possible value: <input type="checkbox"/> DAILY (for reports created on a daily basis)
Activity Indicator	Shows whether the report displays activities or only lists information from the possible values: <input type="checkbox"/> True <input type="checkbox"/> False

General Statement Information	
Covered Period from	Shows the date and time from which the data are covered in the report. Displayed format is: YYYY-MM-DD hh:mm:ss
Covered Period to	Shows the date and time until which the data are covered in the report. Displayed format is: YYYY-MM-DD hh:mm:ss
Report Owner BIC	Shows the BIC of the party whose data are reported.
Report Owner Parent BIC	Shows the parent BIC of the party whose data are reported.
System Entity Wide Report	Shows whether the report is a community report (covering all information referring to a system entity) or a party based report (covering all information referring to a party) from the possible values: <input type="checkbox"/> True <input type="checkbox"/> False
General Information	
Securities Account Number	Shows the number of the securities account.
Securities Account Owner BIC	Shows the BIC of the party which owns the securities account.
Securities Account Owner Parent BIC	Shows the parent BIC of the party.
Intra-Position Movement Information	
Repetitive Block for each Intra-Position Movement	
T2S Intra-Position Movement Reference	
Intra-Position Movement Reference	Shows the identification of the instruction assigned by T2S.
Intra-Balance Movement Details	
ISIN	Shows the ISIN of the security.
Settlement Type	Shows the type of settlement from the possible values: <input type="checkbox"/> UNIT (Units) <input type="checkbox"/> FAMT (Face Amount)
Original Settlement Quantity	Shows the quantity of securities to be settled.

General Statement Information	
Previously Settled Quantity	Shows the quantity settled before the reporting period.
Remaining Quantity	Shows the remaining number of securities to be settled.
Settled Settlement Quantity	Shows the number of securities which was settled on the current business day/during the reporting period.
Actual Settlement Date	Shows the date of the settlement. Displayed format is: YYYY-MM-DD
Accepted Timestamp (SF1)	Shows the accepted timestamp of the settlement restriction. Displayed format is: YYYY-MM-DD hh:mm:ss:µsµsµsµsµs
Restriction Type Balance from	Shows the restriction type code of a position of the debited securities account.
Issuer	Shows the entity assigning the identification. The fixed value is 'T2S'.
Scheme Name	Shows the name of the scheme. The fixed value is 'RT' (for restriction type).
Restriction Type Balance to	Shows the restriction type code of a position of the credited securities account.
Issuer	Shows the entity assigning the identification. The fixed value is 'T2S'.
Scheme Name	Shows the name of the scheme. The fixed value is 'RT' (for restriction type).
Restriction Reference	Shows the identification of the restriction assigned by T2S.

2.4.1.19 Available Report - Statement of Settlement Allegements - Details Screen

Context of Usage

This screen displays detailed information on statements of settlement allegations, which provide information about the list of all settlement instructions received from other T2S actors missing a corresponding securities settlement instruction.

The report displayed in this screen has to be already created in accordance with its report configuration.

This screen is not relevant for CB and payment bank/settlement bank users.

Screen Access

Services >> Additional Services >> Reports >> *Available reports – search/list* screen >> Click on the *search* and/or *details* button

- Services >> Additional Services >> Reports >> **Available reports – search/list** screen >> Click on the **search** and/or **details** button >> **Available report – details** screen >> Click on the **details** button

Privileges

To use this screen, you need the following privilege [▶ 1203]:

- Report details query

References**User Instructions Part**

This screen is part of the following business scenario:

- View available reports

Business Functionality Document

This screen corresponds to the following business function:

- Display generated report details (T2S.GUI.INSE.RPT.0090)

Available Report - Statement of Settlement Allegements - Details Screen

Screenshot

SECURITIES	CASH	SERVICES	STATIC DATA	MONITORING																																																																				
<p>Services > Additional Services > Reports > Report Details > Statement of Settlement Allegements</p>																																																																								
<p>General Information</p> <p>General Statement Information</p> <table border="1"> <tr> <td>Report Name Statement of Settlement Allegements</td> <td>Delta Mode No</td> <td>Statement Number 20210409AF00082</td> </tr> <tr> <td>Report Number 1050062670</td> <td>Frequency DAIL</td> <td>Scheduled 13:44</td> </tr> <tr> <td>Activity Indicator True</td> <td>Covered Period from 2021-04-08 11:05:29</td> <td>Covered Period to 2021-04-09 13:44:00</td> </tr> <tr> <td>Report Owner BIC CSDNLADXXX</td> <td>Report Owner Parent BIC TCSOTC80XXX</td> <td>System Entity Wide Report Yes</td> </tr> </table> <p>Party Information</p> <table border="1"> <tr> <td>Alleged Party BIC CSDNLADXXX</td> <td>Alleged Party Parent BIC TCSOTC80XXX</td> </tr> </table>					Report Name Statement of Settlement Allegements	Delta Mode No	Statement Number 20210409AF00082	Report Number 1050062670	Frequency DAIL	Scheduled 13:44	Activity Indicator True	Covered Period from 2021-04-08 11:05:29	Covered Period to 2021-04-09 13:44:00	Report Owner BIC CSDNLADXXX	Report Owner Parent BIC TCSOTC80XXX	System Entity Wide Report Yes	Alleged Party BIC CSDNLADXXX	Alleged Party Parent BIC TCSOTC80XXX																																																						
Report Name Statement of Settlement Allegements	Delta Mode No	Statement Number 20210409AF00082																																																																						
Report Number 1050062670	Frequency DAIL	Scheduled 13:44																																																																						
Activity Indicator True	Covered Period from 2021-04-08 11:05:29	Covered Period to 2021-04-09 13:44:00																																																																						
Report Owner BIC CSDNLADXXX	Report Owner Parent BIC TCSOTC80XXX	System Entity Wide Report Yes																																																																						
Alleged Party BIC CSDNLADXXX	Alleged Party Parent BIC TCSOTC80XXX																																																																							
<p>Settlement Allegement 1 of 1</p> <p>Instruction References</p> <table border="1"> <tr> <td>Account Owner Reference Dart</td> <td>Account Servicer Reference S1020ZV01</td> <td>Unique T2S Technical Identifier of a Settlement Instruction 21040800284953</td> </tr> <tr> <td>Third Party Reference ---</td> <td>Common Reference ---</td> <td></td> </tr> </table> <p>Allegement Status ---</p> <p>Trade Timeline</p> <table border="1"> <tr> <td>Trade Date 2021-04-09</td> <td>Settlement Date 2021-04-09</td> </tr> </table> <p>Trade Information</p> <table border="1"> <tr> <td>Securities Movement Type DELI</td> <td>Payment Type AFMT</td> <td>Beneficial Ownership Yes</td> </tr> <tr> <td>Place of Clearing CSDNLADXXX</td> <td>Place of Trade ---</td> <td>Proprietary Identification ---</td> </tr> <tr> <td>Issuer ---</td> <td>Schema Name ---</td> <td>ISIN NLCDNL000080</td> </tr> <tr> <td>Name CSDNLADXXX / NLCDNL000080</td> <td></td> <td></td> </tr> <tr> <td>Deal Price Yielded ---</td> <td>Value Type ---</td> <td>Rate % ---</td> </tr> <tr> <td>Amount ---</td> <td>Currency ---</td> <td>Number of Days Accrued ---</td> </tr> <tr> <td>Settlement Quantity Settlement Quantity 85000.00</td> <td>Settlement Type FAMT</td> <td></td> </tr> <tr> <td>Settlement Amount Credit Debit Indicator CRDT</td> <td>Settlement Amount 85.00</td> <td>Settlement Currency EUR</td> </tr> <tr> <td>Original Ordered Amount 0</td> <td>Original Ordered Currency EUR</td> <td>Unit Currency ---</td> </tr> <tr> <td>Quoted Currency ---</td> <td>Exchange Rate ---</td> <td>Resulting Amount ---</td> </tr> </table> <p>Status Information</p> <table border="1"> <tr> <td>CumEx Indicator ---</td> <td>ISO Transaction Type Code TRAD</td> <td>Settlement Transaction Condition Indicator ---</td> </tr> <tr> <td>Partial Settlement Indicator NEAR</td> <td>Market Client Side ---</td> <td></td> </tr> </table> <p>Delivering Settlement Parties</p> <table border="1"> <tr> <td>Delivering CSD CSDNLADXXX</td> <td></td> <td></td> </tr> <tr> <td>Delivering T2S Party PMBDNLB0XXX</td> <td>Delivering Party - Securities Account CSDPCDNL0007</td> <td>Declarations details DCA</td> </tr> <tr> <td>Client of the Delivering CSD Participant PMBDNLB0XXX</td> <td>Safekeeping Account CSDPCDNL0005</td> <td></td> </tr> <tr> <td>Delivering Party 3 PMBDNLB0XXX</td> <td>Safekeeping Account SafekeepingAccount3</td> <td></td> </tr> </table> <p>Receiving Settlement Parties</p> <table border="1"> <tr> <td>Receiving CSD CSDNLADXXX</td> <td></td> <td></td> </tr> <tr> <td>Receiving T2S Party NCSDNLADXXX</td> <td>Declarations details RRR</td> <td></td> </tr> <tr> <td>Client of the Delivering CSD Participant NCSDNLADXXX</td> <td>Safekeeping Account CSDPCDNL0014</td> <td></td> </tr> <tr> <td>Receiving Party 3 PMBDNLB0XXX</td> <td>Safekeeping Account SafekeepingAccount3</td> <td></td> </tr> </table>					Account Owner Reference Dart	Account Servicer Reference S1020ZV01	Unique T2S Technical Identifier of a Settlement Instruction 21040800284953	Third Party Reference ---	Common Reference ---		Trade Date 2021-04-09	Settlement Date 2021-04-09	Securities Movement Type DELI	Payment Type AFMT	Beneficial Ownership Yes	Place of Clearing CSDNLADXXX	Place of Trade ---	Proprietary Identification ---	Issuer ---	Schema Name ---	ISIN NLCDNL000080	Name CSDNLADXXX / NLCDNL000080			Deal Price Yielded ---	Value Type ---	Rate % ---	Amount ---	Currency ---	Number of Days Accrued ---	Settlement Quantity Settlement Quantity 85000.00	Settlement Type FAMT		Settlement Amount Credit Debit Indicator CRDT	Settlement Amount 85.00	Settlement Currency EUR	Original Ordered Amount 0	Original Ordered Currency EUR	Unit Currency ---	Quoted Currency ---	Exchange Rate ---	Resulting Amount ---	CumEx Indicator ---	ISO Transaction Type Code TRAD	Settlement Transaction Condition Indicator ---	Partial Settlement Indicator NEAR	Market Client Side ---		Delivering CSD CSDNLADXXX			Delivering T2S Party PMBDNLB0XXX	Delivering Party - Securities Account CSDPCDNL0007	Declarations details DCA	Client of the Delivering CSD Participant PMBDNLB0XXX	Safekeeping Account CSDPCDNL0005		Delivering Party 3 PMBDNLB0XXX	Safekeeping Account SafekeepingAccount3		Receiving CSD CSDNLADXXX			Receiving T2S Party NCSDNLADXXX	Declarations details RRR		Client of the Delivering CSD Participant NCSDNLADXXX	Safekeeping Account CSDPCDNL0014		Receiving Party 3 PMBDNLB0XXX	Safekeeping Account SafekeepingAccount3	
Account Owner Reference Dart	Account Servicer Reference S1020ZV01	Unique T2S Technical Identifier of a Settlement Instruction 21040800284953																																																																						
Third Party Reference ---	Common Reference ---																																																																							
Trade Date 2021-04-09	Settlement Date 2021-04-09																																																																							
Securities Movement Type DELI	Payment Type AFMT	Beneficial Ownership Yes																																																																						
Place of Clearing CSDNLADXXX	Place of Trade ---	Proprietary Identification ---																																																																						
Issuer ---	Schema Name ---	ISIN NLCDNL000080																																																																						
Name CSDNLADXXX / NLCDNL000080																																																																								
Deal Price Yielded ---	Value Type ---	Rate % ---																																																																						
Amount ---	Currency ---	Number of Days Accrued ---																																																																						
Settlement Quantity Settlement Quantity 85000.00	Settlement Type FAMT																																																																							
Settlement Amount Credit Debit Indicator CRDT	Settlement Amount 85.00	Settlement Currency EUR																																																																						
Original Ordered Amount 0	Original Ordered Currency EUR	Unit Currency ---																																																																						
Quoted Currency ---	Exchange Rate ---	Resulting Amount ---																																																																						
CumEx Indicator ---	ISO Transaction Type Code TRAD	Settlement Transaction Condition Indicator ---																																																																						
Partial Settlement Indicator NEAR	Market Client Side ---																																																																							
Delivering CSD CSDNLADXXX																																																																								
Delivering T2S Party PMBDNLB0XXX	Delivering Party - Securities Account CSDPCDNL0007	Declarations details DCA																																																																						
Client of the Delivering CSD Participant PMBDNLB0XXX	Safekeeping Account CSDPCDNL0005																																																																							
Delivering Party 3 PMBDNLB0XXX	Safekeeping Account SafekeepingAccount3																																																																							
Receiving CSD CSDNLADXXX																																																																								
Receiving T2S Party NCSDNLADXXX	Declarations details RRR																																																																							
Client of the Delivering CSD Participant NCSDNLADXXX	Safekeeping Account CSDPCDNL0014																																																																							
Receiving Party 3 PMBDNLB0XXX	Safekeeping Account SafekeepingAccount3																																																																							

Illustration 111: Available report - statement of settlement allegements - details screen

Field Descriptions

General Statement Information	
Statement of Settlement Allegements	
Report Name	Shows the name of the report.
Delta Mode	Shows if the report is a delta report or not. Possible values are:

General Statement Information	
	<input type="checkbox"/> Yes <input type="checkbox"/> No
Statement Number	Shows the statement number of the report composed of the business date and report type (2-letter abbreviation depending on report type and Delta/Full-Flag) and the sequential number, which is unique in T2S. The number increases for each report.
Report Number	Shows the sequential number of the report which is specific for a report receiving party. This number will only be displayed if the sending user belongs to a report receiving party.
Frequency	Shows the frequency of the report, which is always 'DAILY'.
Scheduled	Shows the name of the business event or time triggering the report creation.
Activity Indicator	Shows whether the report displays activities or only lists information from the possible values: <input type="checkbox"/> True <input type="checkbox"/> False
Covered Period from	Shows the date and time from which the data are covered in the report. Displayed format is: YYYY-MM-DD hh:mm:ss
Covered Period to	Shows the date and time until which the data are covered in the report. Displayed format is: YYYY-MM-DD hh:mm:ss
System Entity Wide Report	Shows whether the report is a community report (covering all information referring to a system entity) or a party based report (covering all information referring to a party) from the possible values: <input type="checkbox"/> True <input type="checkbox"/> False
Report Owner BIC	Shows the party BIC of the report owner.
Report Owner Parent BIC	Shows the parent BIC of the report owner.
Allegement Details	

General Statement Information	
Instruction References	
Account Owner Reference	Shows the identification of the transaction that could potentially match with the notified allegation.
Account Servicer Reference	Shows the identification of the transaction assigned by the CSD. This field is optional.
Allegation Technical Identifier	Shows the identification of the transaction assigned by T2S.
Third Party Reference	Shows the identification of the instruction assigned by a third party. This field is optional.
Trade Identification	Shows the identification of the trade assigned by the investor or the trading party. This reference is used throughout the trade life cycle to access or update the trade details. This field is optional and repetitive.
Common Reference	Shows the identification the 2 trade counterparties agreed in order to identify the trade. This field is optional.
Allegation Status	
Allegation Status	Shows the status of the allegation from the possible values: <input type="checkbox"/> Sent (default value) <input type="checkbox"/> Removed <input type="checkbox"/> Cancelled
Trade Timeline	
Trade Date	Shows the date when the contract was made. Displayed format is: YYYY-MM-DD
Settlement Date	Shows the date when the securities are to be delivered or received. Displayed format is: YYYY-MM-DD
Trade Information	
Securities Movement Type Code	Shows the movement on a securities account from the possible values: <input type="checkbox"/> DELI (for delivery)

General Statement Information	
	<input type="checkbox"/> RECE (for receive)
Payment Type	Shows the type of the payment from the possible values: <input type="checkbox"/> APMT (for against payment settlement) <input type="checkbox"/> FREE (for separate settlement)
Beneficial Ownership	Shows if there is a change of beneficial ownership <input type="checkbox"/> No <input type="checkbox"/> Yes
Place of Trade Identifier	Shows the identification of the place of trade via the market identifier code. Either this field or the description of the place of trade is available.
Place of Clearing	Shows the BIC code of the Clearing House involved in the settlement (if any).
Description	Shows the description of the place of trade. Either this field or the MIC Id is available.
Type Code	Shows the market type code from the possible values: <input type="checkbox"/> EXCH (for stock exchange) <input type="checkbox"/> OTCO (for over the counter) <input type="checkbox"/> PRIM (for primary market) <input type="checkbox"/> SECM (for secondary market) <input type="checkbox"/> VARI (for various) Either this field or the proprietary identification of the place of trade in addition to the issuer and scheme name is available.
Proprietary Identification	Shows the proprietary identification of the allegation assigned by the issuer of the data source scheme. Either this field in addition to the issuer and scheme name or the code of the place of trade is available.
Issuer	Shows the issuer of the proprietary identification. Either this field in addition to the proprietary identification and scheme name or the code of the place of trade is available.
Scheme Name	Shows the description of the data source scheme.

General Statement Information	
	Either this field in addition to the proprietary identification and the issuer or the code of the place of trade is available.
ISIN	Shows the ISIN of the security.
Securities Name	Shows the name of the security.
Deal Price - Yielded	Shows whether the price is expressed as a yield from the possible values: <input type="checkbox"/> Yes <input type="checkbox"/> No This field is optional.
Deal Price – Value Type	Shows the type of the value in which the price is expressed. This field is optional and only filled in if the deal price is not expressed as a yield.
Deal Price – Rate %	Shows the price expressed as a rate. This field is optional.
Deal Price - Amount	Shows price expressed as the value of the security. This field is optional.
Deal Price - Currency	Shows the currency of the security. This field is optional.
Number of Days Accrued	Shows the number of days on which the interest rate accrues. This field is optional.
Settlement Quantity	
Settlement Quantity	Shows the quantity of the security to be settled.
Settlement Type	Shows the type of settlement from the possible values: <input type="checkbox"/> UNIT (Units) <input type="checkbox"/> FAMT (Face Amount)
Settlement Amount	
Debit Credit Indicator	Shows if an operation is a credit or a debit from the possible values: <input type="checkbox"/> CRDT (for credit) <input type="checkbox"/> DBIT (for debit)

General Statement Information	
Settlement Amount	Shows the amount to be paid or received in exchange for the securities.
Settlement Currency	Shows the currency of the settlement.
Original Ordered Amount	Shows the posting or settlement amount in its original currency. This field is only available, if a conversion from/into another currency has occurred.
Original Ordered Currency	Shows the currency of the original ordered amount. This field is only available, if a conversion from/into another currency has occurred.
Unit Currency	Shows the currency in which the rate of exchange is expressed in a currency exchange. This field is optional.
Quoted Currency	Shows the currency into which the base currency is converted in a currency exchange. This field is optional.
Exchange Rate	Shows the factor used for the conversion of an amount from 1 currency into another reflecting the price at which the currency was bought with another currency. This field is optional.
Resulting Amount	Shows the value and currency after a currency conversion. This field is optional.
Settlement Parameters	
CUM/EX Indicator	Shows if a security is traded with or without coupon from the possible values: <input type="checkbox"/> CUM (for cum coupon) <input type="checkbox"/> EX (for ex coupon)
ISO Transaction Type Code	Shows the ISO 20022 code of the securities transaction type. For details please see UDFS chapter 4.2.1.
Opt-Out ISO Settlement Transaction Condition Indicator	Shows the conditions under which the order/trade is to be settled.
Partial Settlement Indicator	Shows if the settlement instruction is allowed to be subject to partial settlement from the possible values: <input type="checkbox"/> NPAR (for no partial settlement allowed)

General Statement Information	
	<input type="checkbox"/> PART (for partial settlement allowed without restrictions) <input type="checkbox"/> PARC (for partial settlement allowed but the settlement amount must not be below the threshold) <input type="checkbox"/> PARQ (for partial settlement allowed but the quantity must not be below the threshold)
Market Client Side	Shows the market or client side information as an ISO 20022 code from the possible values: <input type="checkbox"/> CLNT (for client side) <input type="checkbox"/> MAKT (for market side)
Settlement Parties	
Delivering Parties	
Delivering Depository	
Party BIC	Shows the BIC of the CSD delivering the securities.
Processing Identification	Shows the reference of the instruction assigned by the delivering depository. This field is optional.
Delivering CSD Participant	
Party BIC	Shows the BIC of the delivering CSD participant.
Securities Account Number	Shows the securities account number of the delivering CSD participant. This field is optional.
Processing Identification	Shows the reference of the instruction assigned by the delivering CSD participant. This field is optional.
Contact Details	Shows the contact details of the delivering CSD participant. This field is optional.
Declaration Details	Provides declaration details narrative relative to the party.
Client of the Delivering CSD Participant	
Party BIC	Shows the client of the delivering CSD participant BIC. This field is optional.
Identification	Shows the unique and unambiguous identifier, as assigned to a financial institution using a proprietary identification scheme.

General Statement Information	
	This field is optional.
Issuer	Shows the name of the issuer of the proprietary identifier. This field is optional.
Scheme Name	Shows the name of the scheme. This field is optional.
Name	Shows the name and address of the client. This field is optional.
Processing Identification	Shows the unambiguous identification of the transaction for the party identified. This field is optional.
Contact Details	Shows the contact details of the client. This field is optional.
Safekeeping Account	Account to or from which a securities entry is made.
Delivering Party 3	
Party BIC	Shows the BIC of the delivering party 3. This field is conditional.
Identification	Shows the identification of the processing provided by the party. This field is conditional.
Issuer	Shows the entity that assigns the identification. This field is conditional.
Scheme Name	Shows the name of the scheme. This field is conditional.
Name	Shows the name of the delivering party 3. This field is conditional.
Identification	Shows the unambiguous identification of the transaction for the delivering party 3 identified. This field is optional.
Contact Details	Shows the contact details of the delivering party 3. This field is optional.
Safekeeping Account	Account to or from which a securities entry is made.

General Statement Information	
Delivering Party 4	
Party BIC	Shows the BIC of the delivering party 4. This field is conditional.
Identification	Shows the identification of the processing provided by the party. This field is conditional.
Issuer	Shows the entity that assigns the identification. This field is conditional.
Scheme Name	Shows the name of the scheme. This field is conditional.
Name	Shows the name of the delivering party 4. This field is conditional.
Identification	Shows the unambiguous identification of the transaction for the delivering party 4 identified. This field is optional.
Contact Details	Shows the contact details of the delivering party 4. This field is optional.
Delivering Party 5	
Party BIC	Shows the BIC of the delivering party 5. This field is conditional.
Identification	Shows the identification of the processing provided by the party. This field is conditional.
Issuer	Shows the entity that assigns the identification. This field is conditional.
Scheme Name	Shows the name of the scheme. This field is conditional.
Name	Shows the name of the delivering party 5. This field is conditional.
Identification	Shows the unambiguous identification of the transaction for the delivering party 5 identified. This field is optional.
Contact Details	Shows the contact details of the delivering party 5.

General Statement Information	
	This field is optional.
Settlement Parties	
Receiving Parties	
Receiving Depository	
Party BIC	Shows the BIC of the CSD receiving the securities.
Processing Identification	Shows the reference of the instruction assigned by the receiving depository. This field is optional.
Receiving CSD Participant	
Party BIC	Shows the BIC of the receiving CSD participant.
Securities Account Number	Shows the securities account number of the receiving CSD participant. This field is optional.
Processing Identification	Shows the reference of the instruction assigned by the receiving CSD participant. This field is optional.
Contact Details	Shows the contact details of the receiving CSD participant. This field is optional.
Declaration Details	Provides declaration details narrative relative to the party.
Client of the Receiving CSD Participant	
Party BIC	Shows the client of the receiving CSD participant BIC. This field is optional.
Identification	Shows the unique and unambiguous identifier, as assigned to a financial institution using a proprietary identification scheme. This field is optional.
Issuer	Shows the name of the issuer of the proprietary identifier. This field is optional.
Scheme Name	Shows the name of the scheme. This field is optional.
Name	Shows the name and address of the client. This field is optional.
Processing Identification	Shows the unambiguous identification of the transaction for the party identified.

General Statement Information	
	This field is optional.
Contact Details	Shows the contact details of the client. This field is optional.
Safekeeping Account	Account to or from which a securities entry is made.
Receiving Party 3	
Party BIC	Shows the BIC of the receiving party 3. This field is conditional.
Identification	Shows the identification of the processing provided by the party. This field is conditional.
Issuer	Shows the entity that assigns the identification. This field is conditional.
Scheme Name	Shows the name of the scheme. This field is conditional.
Name	Shows the name of the receiving party 3. This field is conditional.
Identification	Shows the unambiguous identification of the transaction for the receiving party 3 identified. This field is optional.
Contact Details	Shows the contact details of the receiving party 3. This field is optional.
Safekeeping Account	Account to or from which a securities entry is made.
Receiving Party 4	
Party BIC	Shows the BIC of the receiving party 4. This field is conditional.
Identification	Shows the identification of the processing provided by the party. This field is conditional.
Issuer	Shows the entity that assigns the identification. This field is conditional.
Scheme Name	Shows the name of the scheme.

General Statement Information	
	This field is conditional.
Name	Shows the name of the receiving party 4. This field is conditional.
Identification	Shows the unambiguous identification of the transaction for the receiving party 4 identified. This field is optional.
Contact Details	Shows the contact details of the receiving party 4. This field is optional.
Receiving Party 5	
Party BIC	Shows the BIC of the receiving party 5. This field is conditional.
Identification	Shows the identification of the processing provided by the party. This field is conditional.
Issuer	Shows the entity that assigns the identification. This field is conditional.
Scheme Name	Shows the name of the scheme. This field is conditional.
Name	Shows the name of the receiving party 5. This field is conditional.
Identification	Shows the unambiguous identification of the transaction for the receiving party 5 identified. This field is optional.
Contact Details	Shows the contact details of the receiving party 5. This field is optional.

2.4.1.20 Available Report - Statement of Transactions - Details Screen

Context of Usage

This screen displays detailed information on the selected statement of transactions. No new report will be created by entering this screen. The report will be shown in a new window. The report displayed in this screen has to be already created in accordance with its report configuration.

For large reports the user has the option to view them in portions of up to 500 transactions. Only the current portion of the report will be available for a download or print.

This screen is not relevant for CB and payment bank/settlement bank users.

**Screen
Access**

- Services >> Additional Services >> Reports >> *Available reports – search/list* screen >> Click on the *search* and/or *details* button >> *Available report – details* screen >> Click on the *details* button

Privileges

To use this screen, you need the following privilege [▶ 1204]:

- Report details query

References**User Instructions Part**

This screen is part of the following business scenario:

- View available reports

Business Functionality Document

This screen corresponds to the following business function:

- Display generated report details (T2S.GUI.INSE.RPT.0090)

Screenshot

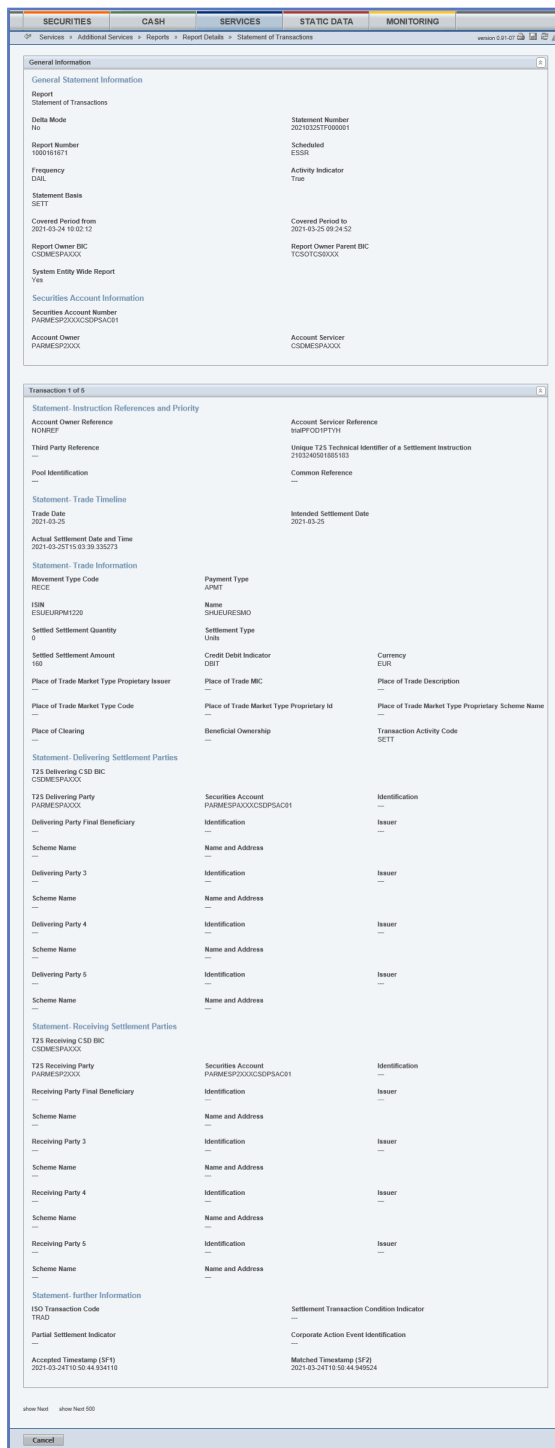

Illustration 112: Available report - statement of transactions - details screen

Field Descriptions

General Statement Information	
Report Name	Shows the name of the report.
Delta Mode	Shows if the report is a delta report or not. Possible values are: <input type="checkbox"/> Yes

General Statement Information	
	<input type="checkbox"/> No
Statement Number	Shows the statement number of the report composed of the business date and report type (2-letter abbreviation depending on report type and Delta/Full-Flag) and the sequential number, which is unique in T2S. The number increases for each report.
Report Number	Shows the sequential number of the report which is specific for a report receiving party. This number will only be displayed if the sending user belongs to a report receiving party.
Scheduled	Shows the name of the business event or time triggering the report creation.
Frequency	Shows the frequency of the report, which is always 'DAILY'.
Statement Basis	Shows the basis of the statement from the possible value: <input type="checkbox"/> SETT (for settled) The statement basis is a mandatory field in the message. The ISO message allows several possible values, but T2S allows only 'SETT'.
Activity Indicator	Shows whether the report displays activities or only lists information from the possible values: <input type="checkbox"/> True <input type="checkbox"/> False
Covered Period from	Shows the date and time from which the data are covered in the report. Displayed format is: YYYY-MM-DD hh:mm:ss
Covered Period to	Shows the date and time until which the data are covered in the report. Displayed format is: YYYY-MM-DD hh:mm:ss
Report Owner BIC	Shows the BIC whose data is reported on
Report Owner Parent BIC	Shows the Parent BIC whose data is reported on
System Entity Wide Report	Shows whether the report is a community report (covering all information referring to a system entity) or a party based report (covering all information referring to a party) from the possible values:

General Statement Information	
	<input type="checkbox"/> Yes <input type="checkbox"/> No
Securities Account Information	
Securities Account Number	Shows the number of the securities account on which the report is based.
Securities Account Owner BIC	Shows the BIC of the party owning the securities account.
Securities account Servicer BIC	Shows the BIC of the party operating the securities account.
Transaction	
Statement - Instruction References and Priority	
Account Owner Reference	Shows the identification of the instruction assigned by the T2S delivering/receiving party.
Account Servicer Reference	Shows the identification of the transaction assigned by the CSD.
Third Party Reference	Shows the identification of the instruction assigned by a third party.
Settlement Instruction Technical Identifier	Shows the identification of the instruction assigned by T2S.
Pool Instruction Reference	Shows the identification of a pool of settlement instructions or settlement restrictions.
Common Reference	Shows the identification the 2 trade counterparties agreed in order to identify the trade. This field is optional.
Statement - Trade Timeline	
Trade Date	Shows the date when the contract was made. Displayed format is: YYYY-MM-DD
Intended Settlement Date	Shows the date when the instruction is forwarded to settlement for the first time. Displayed format is: YYYY-MM-DD
Actual Settlement Date	Shows the date of the settlement. Displayed format is: YY-MM-DD
Accepted Timestamp (SF1)	Shows the accepted timestamp of the settlement instruction. Displayed format is: YYYY-MM-DD hh:mm:ss:µsµsµsµsµsµs

General Statement Information	
Matched Timestamp (SF2)	Shows the matched timestamp of the settlement instruction. Displayed format is: YYYY-MM-DD hh:mm:ss:µsµsµsµsµs
Statement - Trade Information	
Movement Type Code	Shows the type of the movement on a securities account from the possible values: <input type="checkbox"/> DELI (for delivery) <input type="checkbox"/> RECE (for receive)
Payment Type	Shows the type of the payment from the possible values: <input type="checkbox"/> APMT (for against payment settlement) <input type="checkbox"/> FREE (for separate settlement)
ISIN	Shows the ISIN of the security.
Securities Name	Shows the name of the security.
Settled Settlement Quantity	Shows the settled settlement quantity which was settled on the current business day/during the reporting period.
Settlement Type	Shows the type of settlement from the possible values: <input type="checkbox"/> UNIT (Units) <input type="checkbox"/> FAMT (Face Amount)
Settled Settlement Amount	Shows the settled settlement amount which was settled on the current business day/during the reporting period.
Debit Credit Indicator	Shows if an operation is a credit or a debit from the possible values: <input type="checkbox"/> CRDT (for credit) <input type="checkbox"/> DBIT (for debit)
Currency	Shows the currency code.
Place of Trade Market Identifier Code	Shows the identification of a financial market, as stipulated in the norm ISO 10383:2012 "Codes for exchanges and market identifications".
Place of Trade Description	Shows the description of the market when no Market Identifier Code is available.
Place of Trade Market Type Code	Shows the market type expressed as an ISO 20022 code.
Place of Trade Market Type Proprietary Identification	Shows the proprietary information, often a code, issued by the data source scheme issuer.

General Statement Information	
Place of Trade Market Type Proprietary Issuer	Shows the entity that assigns the identification.
Place of Trade Market Type Proprietary Scheme Name	Shows a short textual description of the scheme.
Place of Clearing	Shows the BIC code of the Clearing House involved in the settlement (if any).
Beneficial Ownership	Shows if there is a change of beneficial ownership <input type="checkbox"/> Yes <input type="checkbox"/> No
Transaction Activity Code	Specifies the type of activity to which this instruction relates: <input type="checkbox"/> BOLE: Borrowing and Lending Activity; <input type="checkbox"/> CLAI: Market Claim; <input type="checkbox"/> COLL: Collateral Activity; <input type="checkbox"/> CORP: Corporate Action Activity; <input type="checkbox"/> SETT: Settlement and Clearing Activity
Settlement Parties	
Delivering Parties	
Delivering Depository	
Party BIC	Shows the BIC of the CSD delivering the securities.
Delivering CSD Participant	
Party BIC	Shows the BIC of the delivering CSD participant.
Securities Account Number	Shows the securities account number of the delivering CSD participant. This field is optional.
Processing Identification	Shows the reference of the instruction assigned by the delivering CSD participant. This field is optional.
Client of the Delivering CSD Participant	
Party BIC	Shows the client of the delivering CSD participant BIC. This field is optional.

General Statement Information	
Identification	Shows the unique and unambiguous identifier, as assigned to a financial institution using a proprietary identification scheme. This field is optional.
Issuer	Shows the name of the issuer of the proprietary identifier. This field is optional.
Scheme Name	Shows the name of the scheme. This field is optional.
Name	Shows the name and address of the client. This field is optional.
Delivering Party 3	
Party BIC	Shows the BIC of the delivering party 3. This field is conditional.
Identification	Shows the identification of the processing provided by the party. This field is conditional.
Issuer	Shows the entity that assigns the identification. This field is conditional.
Scheme Name	Shows the name of the scheme. This field is conditional.
Name	Shows the name of the delivering party 3. This field is conditional.
Delivering Party 4	
Party BIC	Shows the BIC of the delivering party 4. This field is conditional.
Identification	Shows the identification of the processing provided by the party. This field is conditional.
Issuer	Shows the entity that assigns the identification. This field is conditional.
Scheme Name	Shows the name of the scheme. This field is conditional.
Name	Shows the name of the delivering party 4.

General Statement Information	
	This field is conditional.
Delivering Party 5	
Party BIC	Shows the BIC of the delivering party 5. This field is conditional.
Identification	Shows the identification of the processing provided by the party. This field is conditional.
Issuer	Shows the entity that assigns the identification. This field is conditional.
Scheme Name	Shows the name of the scheme. This field is conditional.
Name	Shows the name of the delivering party 5. This field is conditional.
Settlement Parties	
Receiving Parties	
Receiving Depository	
Party BIC	Shows the BIC of the CSD receiving the securities.
Receiving CSD Participant	
Party BIC	Shows the BIC of the receiving CSD participant.
Securities Account Number	Shows the securities account number of the receiving CSD participant. This field is optional.
Client of the Receiving CSD Participant	
Party BIC	Shows the client of the receiving CSD participant BIC. This field is optional.
Identification	Shows the unique and unambiguous identifier, as assigned to a financial institution using a proprietary identification scheme. This field is optional.
Issuer	Shows the name of the issuer of the proprietary identifier. This field is optional.
Scheme Name	Shows the name of the scheme. This field is optional.

General Statement Information	
Name	Shows the name and address of the client. This field is optional.
Receiving Party 3	
Party BIC	Shows the BIC of the receiving party 3. This field is conditional.
Identification	Shows the identification of the processing provided by the party. This field is conditional.
Issuer	Shows the entity that assigns the identification. This field is conditional.
Scheme Name	Shows the name of the scheme. This field is conditional.
Name	Shows the name of the receiving party 3. This field is conditional.
Receiving Party 4	
Party BIC	Shows the BIC of the receiving party 4. This field is conditional.
Identification	Shows the identification of the processing provided by the party. This field is conditional.
Issuer	Shows the entity that assigns the identification. This field is conditional.
Scheme Name	Shows the name of the scheme. This field is conditional.
Name	Shows the name of the receiving party 4. This field is conditional.
Receiving Party 5	
Party BIC	Shows the BIC of the receiving party 5. This field is conditional.
Identification	Shows the identification of the processing provided by the party. This field is conditional.
Issuer	Shows the entity that assigns the identification.

General Statement Information	
	This field is conditional.
Scheme Name	Shows the name of the scheme. This field is conditional.
Name	Shows the name of the receiving party 5. This field is conditional.
Statement - Further Information	
ISO Transaction Code	Shows the code of the transaction code as defined in ISO 20022.
Settlement Transaction Condition Indicator	Shows the Settlement Transaction Condition Indicator. This field can show multiple Settlement Transaction Condition Indicators.
Partial Settlement Indicator	Shows if the settlement instruction is allowed to be subject to partial settlement from the possible values: <ul style="list-style-type: none"> <input type="checkbox"/> NPAR (for no partial settlement allowed) <input type="checkbox"/> PART (for partial settlement allowed without restrictions) <input type="checkbox"/> PARC (for partial settlement allowed but the settlement amount must not be below the threshold) <input type="checkbox"/> PARQ (for partial settlement allowed but the quantity must not be below the threshold)
Corporate Action Event Identification	Shows the identification of the instruction assigned by the account servicer to identify a corporate action event.

2.4.1.21 Available Report – Daily Penalty List – Details Screen

Context of Usage

This screen displays detailed information on the Daily Penalty List report. The report displayed in this screen has to be already created in accordance with its report configuration. Hence, no new report will be created by entering this screen.

For large reports the user has the option to view them in portions of up to 200 penalties. Only the current portion of the report will be available for downloading or for printing.

This screen is only available for CSD authorised users and T2S Operator user.

Screen Access Services >> Additional Services >> Reports >> *Available reports – search/list* screen >> Click on the *search* and/or *details* button >> *Available report – details* screen >> Click on the *details* button

Privileges To use this screen, you need the following privilege:
 Report details query

References **User Instructions Part**

This screen is part of the following business scenario:

- View available reports

Business Functionality Document

This screen corresponds to the following business function:

- Display generated report details (T2S.GUI.INSE.RPT.0090)

Screenshot

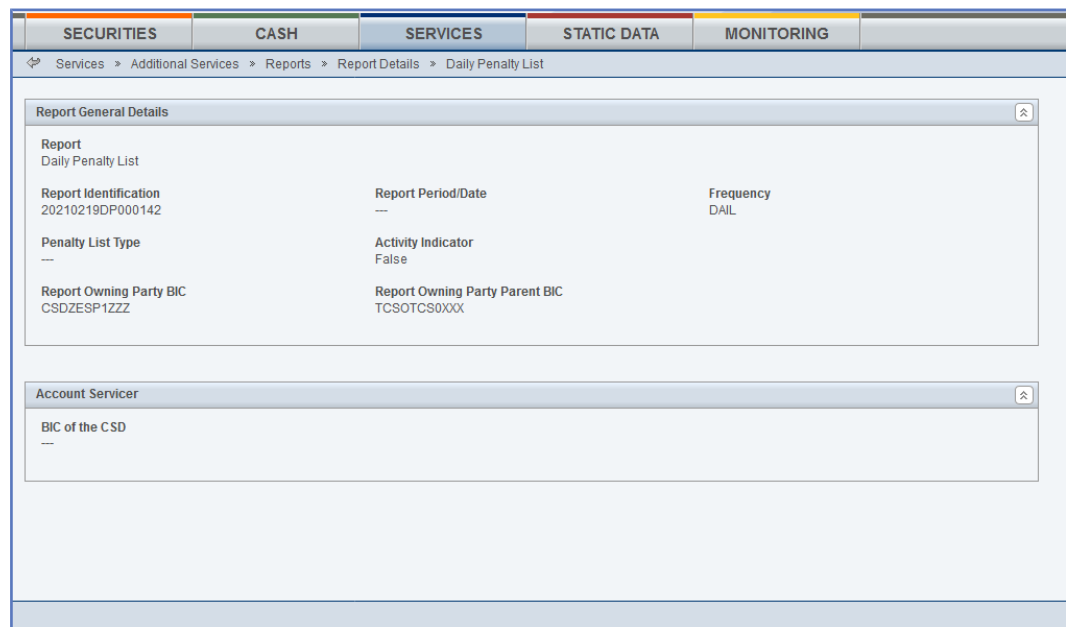

Illustration 113: Available report – daily penalty list – details screen

Field Description

Report General Details	
Report	Shows the name of the report.
Report Identification	Shows the penalty number of the report composed of the business date and report types, sent in pull and push mode by T2S, and the sequential number, which is unique in T2S. The number increases for each report.
Report Period/Date	Shows the date reported by the report.

Report General Details	
Frequency	Indicates the frequency of the generation of the report. The unique possible value is: <input type="checkbox"/> DAIL
Penalty List Type	Shows the new or updated/removed detected penalties. The unique possible value is: <input type="checkbox"/> FWIS this code is used to report a Daily Penalty List created for the first time.
Activity Indicator	Shows if the message contains records or not. The possible values are: <input type="checkbox"/> True <input type="checkbox"/> False
Report Owning Party BIC	Shows the Party BIC whose data is reported on.
Report Owning Party Parent BIC	Shows the Party Parent BIC whose data is reported on.
Account Servicer	
BIC of the CSD	Shows the CSD of the participant whose new penalties (i.e. the one detected on the previous business day) are reported in this message.
Currency, Date and Party	
Currency	Shows the currency of the penalties reported.
Date	Shows the detection date of the penalties.
Party BIC	Shows the BIC of the Party that manages the account on behalf of the party account owner.
Party Type	Shows the Party Type of the Party according to Reference Data. The possible values are:

Report General Details	
	<ul style="list-style-type: none"> <input type="checkbox"/> NCSD is provided when the CSD itself is the failing or non failing party of the penalty/claim. This is used to differentiate between the CSD and the CSD as participant of itself. It is needed because the AccountServicer/Depository of the party provided in the message is the BIC of the CSD of the party, not the parent BIC of the party. Consequently, without this additional identification, it wouldn't be possible to distinguish between a CSD and the CSD as participant of itself. <input type="checkbox"/> CCPA is provided when the failing or non failing party of the penalty/claim is a CCP; i.e.: in T2S this is done by checking if the party has a BIC in the Cash Penalties CCP List (list of BICs). <input type="checkbox"/> CSDP is provided when the failing or non failing party of the penalty/claim is neither a CSD nor a CCP and its party type is CSD Participant. <input type="checkbox"/> EXTE is provided when the failing or non failing party of the penalty/claim is neither a CSD nor a CCP and its party type is an external CSD in T2S.
Counterparty	
BIC of the CSD of the counterparty	Shows the CSD of the counterparty of the penalties reported in this block of the message
Counterparty BIC	Shows the BIC of the Party that manages the account on behalf of the counterparty account owner.

Report General Details	
Counterparty Type	Shows the BIC of the Party that manages the account on behalf of the counterparty account owner. The possible values are: <input type="checkbox"/> NCSD <input type="checkbox"/> CCPA <input type="checkbox"/> CSDP <input type="checkbox"/> EXTE
Aggregated Amount	Shows the net amount of all the newly detected penalties reported for the given business day in the related currency for the relevant party and counterparty.
Credit/Debit	Shows whether the Daily Aggregated Net Amount is due or to be received by the participant. The possible values are: <input type="checkbox"/> DBIT(Debit) <input type="checkbox"/> CRDT(Credit) If no value is retrieve, it will show "---"
Penalty	
Common ID	Shows the reference assigned by T2S to the penalty that is common for both the failing and the non-failing participant.
Individual ID	Shows the reference assigned by T2S to the penalty that is the individual identification of the penalty for the relevant account owner.
Type	Shows the type of the penalty. The possible values are: <input type="checkbox"/> SEFP <input type="checkbox"/> LMFP
Status	Shows the status of the penalty. The unique possible value is:

Report General Details	
	<input type="checkbox"/> ACTV
Amount of the Penalty	Shows the amount computed for the penalty and its corresponding currency.
Credit/Debit Indicator	Shows whether the amount of the penalty is due or to be received by the participant. The possible values are: <ul style="list-style-type: none"> <input type="checkbox"/> DBIT(Debit) <input type="checkbox"/> CRDT(Credit)
Calculation Method	Shows the calculation method used to calculate the penalty. The possible values are: <ul style="list-style-type: none"> <input type="checkbox"/> SECU - The Penalty is based on the quantity of securities failed to be delivered and security penalty rate of the relevant Asset type. <input type="checkbox"/> MIXE - The Penalty is based on the quantity of securities failed to be delivered and penalty rate is the discount rate of the relevant currency. <input type="checkbox"/> CASH - Penalty is based on the amount of cash failed to be delivered and the penalty rate is the discount rate of the relevant currency. <input type="checkbox"/> BOTH - Penalty is the sum of "SECU" and "CASH".
Number of Days	Shows the number of business days the penalty is applicable to.
Calculation Data	
Date	Shows the business day of each sub-amount that forms a penalty.
Missing Reference Data	This information is only provided for penalties where there is missing reference data needed for their calculation. The possible values are:

Report General Details	
	<p><input type="checkbox"/> TRUE – There is missing reference data on the applicable business day.</p> <p><input type="checkbox"/> FALSE – There is no missing reference data on the applicable business day.</p> <p>If not provided, it means the penalty could be calculated and no reference was missing.</p>
ISIN	Shows the ISIN code of the security.
Security Subject to Penalties	<p>Shows whether the security is subject to penalties on this business day or not.</p> <p>The possible values are:</p> <p><input type="checkbox"/> TRUE - The security is subject to penalties.</p> <p><input type="checkbox"/> FALSE - The security is not subject to penalties.</p> <p>When not informed, it will mean "TRUE".</p>
Financial Instrument Type	<p>Shows the type of the financial instrument.</p> <p>The possible values are:</p> <p><input type="checkbox"/> SHRS</p> <p><input type="checkbox"/> SOVR</p> <p><input type="checkbox"/> DEBT</p> <p><input type="checkbox"/> SECU</p> <p><input type="checkbox"/> ETFS</p> <p><input type="checkbox"/> UCIT</p> <p><input type="checkbox"/> MMKT</p> <p><input type="checkbox"/> EMAL</p> <p><input type="checkbox"/> OTHR</p> <p>If no value is retrieve, it will show "---"</p>
Liquidity	Binary classification of securities which indicates whether the underlying instrument is liquid or illiquid.

Report General Details	
	<p>Only provided if:</p> <ul style="list-style-type: none"> <input type="checkbox"/> The Security is Subject to penalties <input type="checkbox"/> The Financial Instrument Type of the security (Classification type) is “SHRS”, and <input type="checkbox"/> The Calculation method code is “SECU” or “BOTH”. <p>The possible values are:</p> <ul style="list-style-type: none"> <input type="checkbox"/> Empty (“---”), it is not relevant for the calculation of the penalty or for information purposes whether the instrument is liquid or illiquid. <input type="checkbox"/> TRUE, the underlying instrument is liquid. <input type="checkbox"/> FALSE, the underlying instrument is illiquid.
Exchange Rate	<p>Shows the value of one currency expressed in relation to another currency (i.e. ExchangeRate expresses the ratio between UnitCurrency and QuotedCurrency).</p> <p>If no value is retrieve, it will show “---”</p>
Unit Currency	<p>Shows the currency in which the rate of exchange is expressed in a currency exchange. It is always EUR.</p> <p>If no value is retrieve, it will show “---”</p>
Quoted Currency	<p>Shows the currency into which the base currency is converted, in a currency exchange. Possible values are:</p> <p>For first FX: The quoted currency is either the currency of the price when the security is in Units, or the currency of the security if the security is in FAMT.</p> <p>If no value is retrieve, it will show “---”</p>

Report General Details	
Exchange Rate	Shows the second value of one currency expressed in relation to another currency (i.e. ExchangeRate expresses the ratio between UnitCurrency and QuotedCurrency), if any.
Unit Currency	Shows the currency in which the rate of exchange is expressed in a currency exchange. It is always EUR.
Quoted Currency	Shows the currency into which the base currency is converted, in a currency exchange. For second FX: The quoted currency is the currency of the penalty: For the time being, it is always DKK.
Place of Trade Market Identifier Code	Shows the identifier Code of the market in which a trade transaction has been executed. Informed only if Security is subject to penalties, Calculation method code is SECU or BOTH and the two underlying matched settlement instructions have the same MIC in their Place of Trade. If MIC differs, the value informed will be "empty".
SME Growth Market	Shows whether the instructions were traded in a SME Growth Market or not. Only provided if: <ul style="list-style-type: none"><input type="checkbox"/> The Security is Subject to penalties<input type="checkbox"/> The Financial Instrument Type of the security (Classification type) is different from SOVR, and<input type="checkbox"/> The Calculation method code is "SECU" or "BOTH". The possible values are:

Report General Details	
	<ul style="list-style-type: none"> <input type="checkbox"/> Empty (“---”), it is not relevant for the calculation of the penalty or for information purposes whether the instructions were traded on a SME Growth Market or not <input type="checkbox"/> TRUE, the instructions were traded on a SME Growth Market. <input type="checkbox"/> FALSE, the instructions were not traded on a SME Growth Market.
Security Penalty Rate	Shows the Securities Penalty Rate applicable for the Asset Type, used when the calculation method code of the penalty is “SECU” or “BOTH”.
Cash Discount Penalty Rate	Shows the discount rate of the relevant currency for the business date. It is provided if the Security is subject to penalties and if the Calculation Method code is “CASH”, “MIXE” or “BOTH”.
Sub-amount Securities	Shows the amount of the penalty for this business day. It is only provided if the number of days is higher than one (i.e. when it is a LMFP and the block calculation details could have more than one instance) or if the calculation method is “BOTH” (in this case also Sub-amount cash is provided)
Sub-amount Cash	Shows the amount of the penalty for this business day. It is only provided if the number of business days is higher than one (i.e. when it is a LMFP and the block calculation details could have more than one instance) or if the calculation method is “BOTH” (in this case also Sub-amount securities is provided)
Related Transaction	
References	

Report General Details	
Account Owner Reference	Shows the reference of an instruction as assigned by the T2S Delivering/Receiving Party.
Account Servicer Reference	Shows the reference of an instruction as assigned by the CSD.
Market Infrastructure Reference	Shows the T2S settlement instruction identification.
Third Party Reference	Shows the reference assigned by the Third Party, if any.
Common Reference	Shows the reference of the Settlement Instruction this Settlement Instruction is matched with.
Corporate Action Event Identification	Shows the identification assigned by the account servicer to unambiguously identify a corporate action event
T2S Matching Reference	Shows the reference provided by T2S when the instruction is matched.
Reference Owner BIC	Shows the BIC of the instructing party of the settlement instruction.
Other details	
Securities Transaction Type	Shows the securities transaction type expressed as an ISO 20022 code from the possible values: <ul style="list-style-type: none"><input type="checkbox"/> AUTO (for auto-collateralisation)<input type="checkbox"/> BSBK (for buy sell back)<input type="checkbox"/> BYIY (for buy-in)<input type="checkbox"/> CLAI (for market claim)<input type="checkbox"/> CNCB (for central bank collateral operation)<input type="checkbox"/> COLI (for collateral in)<input type="checkbox"/> COLO (for collateral out)<input type="checkbox"/> CONV (for depository receipt conversion)<input type="checkbox"/> CORP (for corporate action)<input type="checkbox"/> ETFT (for exchange traded funds)

Report General Details

- FCTA (for factor update)
- INSP (for move of stock)
- ISSU (for depository receipt issue)
- MKDW (for mark down)
- MKUP (for mark up)
- NETT (for netting)
- NSYN (for non syndicated)
- OWNE (for external account transfer)
- OWNI (for internal account transfer)
- PAIR (for pair off)
- PLAC (for placement)
- PORT (for portfolio move)
- REAL (for realignment)
- REBL (Rebalancing)
- REDI (for withdrawal)
- REDM (for redemption)
- RELE (for depository receipt release cancellation)
- REPU (for repo)
- RODE (for return delivery without matching)
- RVPO (for reverse repo)
- SBBK (for sell buy back)
- SBRE (for borrowing reallocation)
- SECB (for securities borrowing)
- SECL (for securities lending)
- SLRE (for lending reallocation)
- SUBS (for subscription)
- SWIF (Switch From)
- SWIT (Switch To)
- SYND (for syndicate underwriters)
- TBAC (for TBA closing)

Report General Details	
	<input type="checkbox"/> TRAD (for trade) <input type="checkbox"/> TRPO (for triparty repo) <input type="checkbox"/> TRVO (for triparty reverse repo) <input type="checkbox"/> TURN (for turnaround)
Intended Settlement Date	Shows the date at which the instruction becomes eligible to be submitted to settlement.
Securities Account Number	Shows the identification of the Securities Account of the Settlement Instruction.
Account Owner BIC	Shows the actual value for the party code owner of the Securities Account.
Securities Movement Type	Shows whether the movement on a securities account results from a deliver or a receive instruction. The possible values are: <input type="checkbox"/> DELI – Delivery <input type="checkbox"/> RECE – Receipt
Payment type code	Shows how the transaction is to be settled. The possible values are: <input type="checkbox"/> APMT – Against payment settlement <input type="checkbox"/> FREE – Separate settlement
Unit Quantity	Shows the unit quantity of securities failed to be delivered.
FAMT Quantity	Shows the FAMT quantity of securities failed to be delivered.
DCA Owner BIC	Shows the BIC of the T2S party owning the Dedicated Cash Account. Only in case of settlement instructions against payment.
Amount	Cash amount failed to be delivered, and its corresponding currency.

Report General Details	
	<p>In case the instruction was partially settled at the moment of the end of cut-off processing used for the calculation of the SEFP, it is the remaining amount at that point in time.</p> <p>For LMFPs it is the matched amount.</p>
Credit/Debit	<p>It must be present when the Original Settlement Amount has a value.</p> <p>The possible values are:</p> <ul style="list-style-type: none"> <input type="checkbox"/> DBIT(Debit) <input type="checkbox"/> CRDT(Credit)
Acknowledged Status TS	Shows the Calendar Date when the acceptance (SF1) of the settlement instruction has occurred
Matched Status Timestamp	Shows the Calendar Date when the matching (SF2) of the settlement instruction has occurred
Failed Reason	<p>T2S sends this status when the Settlement Instruction has not been completely settled and the settlement is not possible at the Intended Settlement Date.</p> <p>It is only provided in case of 'SEFP'</p>
Additional Reason	<p>Shows the combination of the associated business rule and reason code reference,</p> <p>It is only provided in case of 'SEFP'</p>
BD Event Identification	<p>Shows the code identifying the event (i.e. Cut-off- Code identifying the event)</p> <p>It is only provided in case of 'SEFP'</p>
Scheme Name	<p>Shows the name of the scheme.</p> <p>Fixed content to 'EVTP'</p> <p>It is only provided in case of 'SEFP'</p>
Issuer	<p>Shows the entity assigning the identification.</p> <p>Fixed content to 'T2S'</p>

Report General Details	
	It is only provided in case of 'SEFP'
Scheduled Time	Shows the effective time for the schedule of the cut-off It is only provided in case of 'SEFP'
Start Time	Shows the effective time for the trigger of the cut-off It is only provided in case of 'SEFP'
End Time	Shows the effective time for the closure of the Cut-off It is only provided in case of 'SEFP'

2.4.1.22 Available Report – List of Modified Penalties - Details Screen

Context of Usage

This screen displays detailed information on the List of Modified Penalties report. The report displayed in this screen has to be already created in accordance with its report configuration. Hence, no new report will be created by entering this screen.

For large reports the user has the option to view them in portions of up to 200 penalties. Only the current portion of the report will be available for downloading or for printing.

This screen is only available for CSD authorised users and T2S Operator user.

Screen Access

Services >> Additional Services >> Reports >> *Available reports – search/list* screen >> Click on the *search* and/or *details* button >> *Available report – details* screen >> Click on the *details* button

Privileges

To use this screen, you need the following privilege:

Report details query

References

User Instructions Part

This screen is part of the following business scenario:

View available reports

Business Functionality Document

This screen corresponds to the following business function:

Display generated report details (T2S.GUI.INSE.RPT.0090)

Screenshot

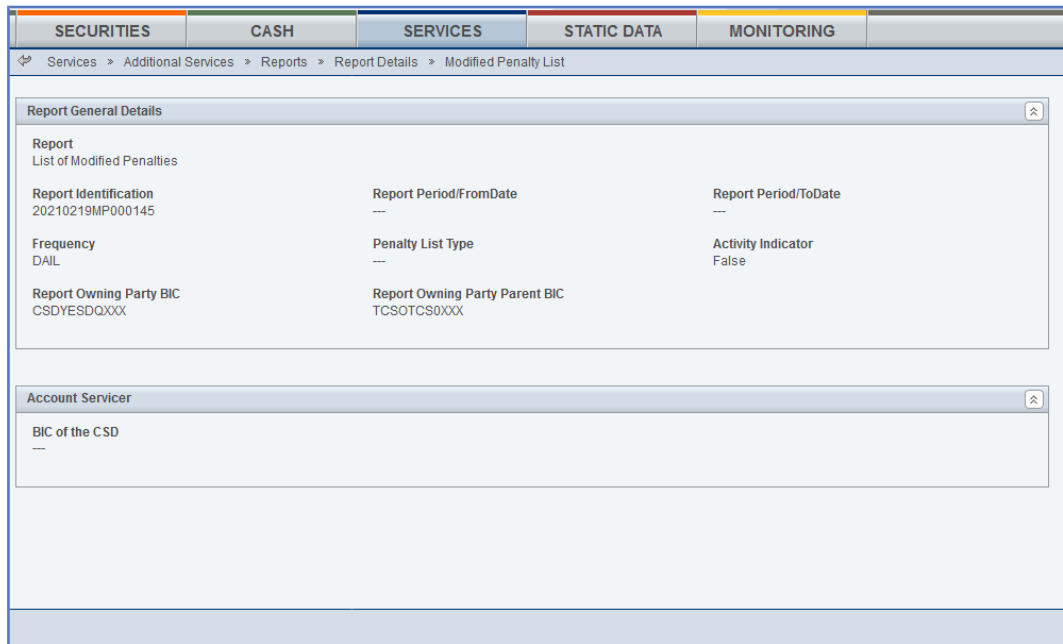

Illustration 114: Available report – list of modified penalties – details screen

Field

Description

Report General Details	
Report	Shows the name of the report.
Report Identification	Shows the penalty number of the report composed of the business date and report types, sent in pull and push mode by T2S, and the sequential number, which is unique in T2S. The number increases for each report.
Reporte Period/FromData	Shows the start date of the range.
Report Period/ToDate	Shows the end date of the range.
Frequency	Indicates the frequency of the generation of the report. The unique possible value is: <input type="checkbox"/> DAIL
Penalty List Type	Shows the new or updated/removed detected penalties. The unique possible value is: <input type="checkbox"/> FWAM this code is used to report a penalty list that has been amended.
Activity Indicator	Shows if the message contains records or not.

Report General Details	
	<p>The possible values are:</p> <ul style="list-style-type: none"> <input type="checkbox"/> True <input type="checkbox"/> False
Report Owning Party BIC	Shows the Party BIC whose data is reported on.
Report Owning Party Parent BIC	Shows the Party Parent BIC whose data is reported on.
Account Servicer	
BIC of the CSD	Shows the CSD of the participant whose modified penalties are reported in this message.
Currency, Date and Party	
Currency	Shows the currency of the modified penalties reported.
Date	Shows the detection date of the penalties.
Party BIC	Shows the BIC of the Party that manages the account on behalf of the party account owner.
Party Type	<p>Shows the Party Type of the Party according to Reference Data.</p> <p>The possible values are:</p> <ul style="list-style-type: none"> <input type="checkbox"/> NCSD is provided when the CSD itself is the failing or the non failing party of the penalty/claim. This is used to differentiate between the CSD and the CSD as participant of itself. It is needed because the AccountServicer/Depository of the party provided in the message is the BIC of the CSD of the party, not the parent BIC of the party. Consequently, without this additional identification, it wouldn't be possible to distinguish between a CSD and the CSD as participant of itself.

Report General Details	
	<ul style="list-style-type: none"> <input type="checkbox"/> CCPA is provided when the failing or non failing party of the penalty/ claim is a CCP; i.e. In T2S this is done by checking if the party has a BIC in the Cash Penalties CCP List (list of BICs). <input type="checkbox"/> CSDP is provided when the failing or non failing party of the penalty/ claim is neither a CSD nor a CCP and its party type is CSD Participant. <input type="checkbox"/> EXTE is provided when the failing or non failing party of the penalty/claim is neither a CSD nor a CCP and its party type is an external CSD in T2S.
Counterparty	
BIC of the CSD of the counterparty	Shows the CSD of the counterparty of the penalties reported in this block of the message.
Counterparty BIC	Shows the BIC of the Party that manages the account on behalf of the counterparty account owner.
Counterparty Type	Shows the BIC of the Party that manages the account on behalf of the counterparty account owner. The possible values are: <ul style="list-style-type: none"> <input type="checkbox"/> NCSD <input type="checkbox"/> CCPA <input type="checkbox"/> CSDP <input type="checkbox"/> EXTE
Aggregated Amount	Shows the net amount of all the penalties reported for the given business day in the related currency for the relevant party and counterparty.

Report General Details	
Credit/Debit	Shows whether the Daily Modified Aggregated Net Amount is due or to be received by the participant. The possible values are: <input type="checkbox"/> DBIT(Debit) <input type="checkbox"/> CRDT(Credit) If no value is retrieve, it will show “---”
Penalty	
Common ID	Shows the reference assigned by T2S to the penalty and that is common for both the failing and the non-failing participant.
Individual ID	Shows the reference assigned by T2S to the penalty and that is the individual identification of the penalty for the relevant account owner.
Reallocation ID	Shows the Common Reference of either the penalty from which the reported penalty was re-allocated or the penalty to which the reported penalty has been re-allocated.
Type	Shows the type of the penalty. The possible values are: <input type="checkbox"/> SEFP <input type="checkbox"/> LMFP
Status	Shows the status of the penalty. The possible values are: <input type="checkbox"/> ACTV <input type="checkbox"/> REMO Note: If the status of the penalty is REMO, the attributes of “Calculation Details” are not visible.
Reason	Shows the reason of the status. The possible values are:

Report General Details	
	<ul style="list-style-type: none"> <input type="checkbox"/> UPDT - Active penalty that has been updated. <input type="checkbox"/> NEWP (New penalty resulting from the insertion of a Security Subject to Penalties with Valid From in the past, or from a contingency scenario) <input type="checkbox"/> RALO - Active or Removed penalty has been re-allocated. <input type="checkbox"/> SWIC - Active penalty has been switched (the failing and the non-failing participant have been swapped by the CSD). <input type="checkbox"/> INSO - Penalty was removed because insolvency proceedings are opened against the failing participant. <input type="checkbox"/> SESU - Penalty was removed because of ISIN suspension from settlement due to a reconciliation issue under. <input type="checkbox"/> SUSP - Penalty was removed because of ISIN suspension from trading <input type="checkbox"/> SEMP - Penalty removed because of settlement on multiple platforms. <input type="checkbox"/> TECH - Penalty was removed because there were technical impossibilities at the CSD level that prevent settlement. <input type="checkbox"/> OTHR - Removed Penalty due to a non-standard reason by the CSD.
Additional Status Reason	Shows the additional description of the reason why the penalty has been Removed with Reason OTHR or Switched.
Amount of the Penalty	Shows the amount of the modified penalty and its corresponding currency.

Report General Details	
Credit/Debit Indicator	Shows whether the penalty is due or to be received by the participant. The possible values are: <input type="checkbox"/> DBIT <input type="checkbox"/> CRDT
Calculation Method	Shows the calculation method used to calculate the penalty. The possible values are: <input type="checkbox"/> SECU - The Penalty is based on the quantity of securities failed to be delivered and security penalty rate of the relevant Asset type. <input type="checkbox"/> MIXE - The Penalty is based on the quantity of securities failed to be delivered and penalty rate is the discount rate of the relevant currency. <input type="checkbox"/> CASH - Penalty is based on the amount of cash failed to be delivered and the penalty rate is the discount rate of the relevant currency <input type="checkbox"/> BOTH - Penalty is the sum of "SECU" and "CASH".
Number of Days	Shows the number of business days the penalty is applicable to.
Calculation Data	
Date	Shows the business day of each sub-amount that forms a penalty.
Missing Reference Data	This information is only provided for penalties where there is missing reference data needed for the penalty calculation. The possible values are: <input type="checkbox"/> TRUE – There is missing reference data on the applicable business day.

Report General Details	
	<p><input type="checkbox"/> FALSE – There is no missing reference data on the applicable business day.</p> <p>If not provided, it means the penalty could be calculated and no reference was missing.</p>
ISIN	Shows the ISIN code of the security.
Security Subject to Penalties	<p>Shows whether the security is subject to penalties on this business day or not.</p> <p>The possible values are:</p> <ul style="list-style-type: none"> <input type="checkbox"/> TRUE - The security is subject to penalties. <input type="checkbox"/> FALSE - The security is not subject to penalties. <p>When not informed, it will mean "TRUE".</p>
Financial Instrument Type	<p>Shows the type of the financial instrument.</p> <p>The possible values are:</p> <ul style="list-style-type: none"> <input type="checkbox"/> SHRS <input type="checkbox"/> SOVR <input type="checkbox"/> DEBT <input type="checkbox"/> SECU <input type="checkbox"/> ETFS <input type="checkbox"/> UCIT <input type="checkbox"/> MMKT <input type="checkbox"/> EMAL <input type="checkbox"/> OTHR <p>If no value is retrieve, it will show "---"</p>
Liquidity	<p>Binary classification of securities which indicates whether the underlying instrument is liquid or illiquid.</p> <p>Only provided if:</p> <ul style="list-style-type: none"> <input type="checkbox"/> The Security is Subject to penalties

Report General Details	
	<ul style="list-style-type: none"> <input type="checkbox"/> The Financial Instrument Type of the security (Classification type) is “SHRS”, and <input type="checkbox"/> The Calculation method code is “SECU” or “BOTH”. <p>The possible values are:</p> <ul style="list-style-type: none"> <input type="checkbox"/> Empty (“---”), it is not relevant for the calculation of the penalty or for information purposes whether the instrument is liquid or illiquid. <input type="checkbox"/> TRUE, the underlying instrument is liquid. <input type="checkbox"/> FALSE, the underlying instrument is illiquid.
Exchange Rate	<p>Shows the value of one currency expressed in relation to another currency (i.e. ExchangeRate expresses the ratio between UnitCurrency and QuotedCurrency).</p> <p>If no value is retrieve, it will show “---”</p>
Unit Currency	<p>Shows the currency in which the rate of exchange is expressed in a currency exchange. It is always EUR.</p> <p>If no value is retrieve, it will show “---”</p>
Quoted Currency	<p>Shows the currency into which the base currency is converted, in a currency exchange. The possible values are:</p> <p>For first FX: The quoted currency is either the currency of the price when the security is in Units, or the currency of the security if the security is in FAMT.</p> <p>If no value is retrieve, it will show “---”</p>

Report General Details	
Exchange Rate	Shows the second value of one currency expressed in relation to another currency (i.e. ExchangeRate expresses the ratio between UnitCurrency and QuotedCurrency, if any.
Unit Currency	Shows the currency in which the rate of exchange is expressed in a currency exchange. It is always EUR.
Quoted Currency	Shows the currency into which the base currency is converted, in a currency exchange. For second FX: The quoted currency is the currency of the penalty: For the time being, it is always DKK.
Place of Trade Market Identifier Code	Shows the identifier Code of the market in which a trade transaction has been executed. Informed only if Security is subject to penalties, Calculation method code is SECU or BOTH and the two underlying matched settlement instructions have the same MIC in their Place of Trade. If MIC differs, the value informed will be "empty".
SME Growth Market	Shows whether the instructions were traded in a SME Growth Market or not. Only provided if: <ul style="list-style-type: none"><input type="checkbox"/> The Security is Subject to penalties<input type="checkbox"/> The Financial Instrument Type of the security (Classification type) is different from SOVR, and<input type="checkbox"/> The Calculation method code is "SECU" or "BOTH". The possible values are:

Report General Details	
	<ul style="list-style-type: none"> <input type="checkbox"/> Empty (“---”), it is not relevant for the calculation of the penalty or for information purposes whether the instructions were traded on a SME Growth Market or not <input type="checkbox"/> TRUE, the instructions were traded on a SME Growth Market. <input type="checkbox"/> FALSE, the instructions were not traded on a SME Growth Market.
Security Penalty Rate	Shows the Securities Penalty Rate applicable for the Asset Type, used when the calculation method code of the penalty is “SECU” or “BOTH”.
Cash Discount Penalty Rate	Shows the discount rate of the relevant currency for the business date. It is provided if the Security is subject to penalties and if the Calculation Method code is “CASH”, “MIXE” or “BOTH”.
Sub-amount Securities	Shows the amount of the penalty for this business day. It is only provided if the number of days is higher than one (i.e. when it is a LMFP and the block calculation details could have more than one instance) or if the calculation method is “BOTH” (in this case also Sub-amount cash is provided)
Sub-amount Cash	Shows the amount of the penalty for this business day. It is only provided if the number of days is higher than one (i.e. when it is a LMFP and the block calculation details could have more than one instance) or if the calculation method is “BOTH” (in this case also Sub-amount securities is provided)
Related Transactions	
References	

Report General Details	
Account Owner Reference	Shows the reference of an instruction as assigned by the T2S Delivering/Receiving Party.
Account Servicer Reference	Shows the reference of an instruction as assigned by the CSD.
Market Infrastructure Reference	Shows the T2S settlement instruction identification.
Third Party Reference	Shows the reference assigned by the Third Party, if any.
Common Reference	Shows the reference which indicates the Settlement Instruction this Settlement Instruction is matched with.
Corporate Action Event Identification	Shows the identification assigned by the account servicer to unambiguously identify a corporate action event
T2S Matching Reference	Shows the reference provided by T2S when the instruction is matched.
Reference Owner BIC	Shows the BIC for the instructing party of the settlement instruction.
Other details (displayed only for Penalties with Reason "NEWP")	
Securities Transaction Type	Shows the securities transaction type expressed as an ISO 20022 code from the possible values: <ul style="list-style-type: none"><input type="checkbox"/> AUTO (for auto-collateralisation)<input type="checkbox"/> BSBK (for buy sell back)<input type="checkbox"/> BYIY (for buy-in)<input type="checkbox"/> CLAI (for market claim)<input type="checkbox"/> CNCB (for central bank collateral operation)<input type="checkbox"/> COLI (for collateral in)<input type="checkbox"/> COLO (for collateral out)<input type="checkbox"/> CONV (for depository receipt conversion)<input type="checkbox"/> CORP (for corporate action)<input type="checkbox"/> ETFT (for exchange traded funds)

Report General Details

- FCTA (for factor update)
- INSP (for move of stock)
- ISSU (for depository receipt issue)
- MKDW (for mark down)
- MKUP (for mark up)
- NETT (for netting)
- NSYN (for non syndicated)
- OWNE (for external account transfer)
- OWNI (for internal account transfer)
- PAIR (for pair off)
- PLAC (for placement)
- PORT (for portfolio move)
- REAL (for realignment)
- REBL (Rebalancing)
- REDI (for withdrawal)
- REDM (for redemption)
- RELE (for depository receipt release cancellation)
- REPU (for repo)
- RODE (for return delivery without matching)
- RVPO (for reverse repo)
- SBBK (for sell buy back)
- SBRE (for borrowing reallocation)
- SECB (for securities borrowing)
- SECL (for securities lending)
- SLRE (for lending reallocation)
- SUBS (for subscription)
- SWIF (Switch From)
- SWIT (Switch To)
- SYND (for syndicate underwriters)
- TBAC (for TBA closing)

Report General Details	
	<input type="checkbox"/> TRAD (for trade) <input type="checkbox"/> TRPO (for triparty repo) <input type="checkbox"/> TRVO (for triparty reverse repo) <input type="checkbox"/> TURN (for turnaround)
Intended Settlement Date	Shows the date at which the instruction becomes eligible to be submitted to settlement.
Securities Account Number	Shows the identification of the Securities Account of the Settlement Instruction.
Account Owner BIC	Shows the actual value for the party code owner of the Securities Account.
Securities Movement Type	Shows whether the movement on a securities account results from a deliver or a receive instruction. The possible values are: <input type="checkbox"/> DELI – Delivery <input type="checkbox"/> RECE – Receipt
Payment type code	Shows how the transaction is to be settled. The possible values are: <input type="checkbox"/> APMT – Against payment settlement <input type="checkbox"/> FREE – Separate settlement
Unit Quantity	Shows the unit quantity of securities failed to be delivered.
FAMT Quantity	Shows the FAMT quantity of securities failed to be delivered.
Dedicated Cash Account Number	Shows the Dedicated Cash Account as per SF1 (if APTM)
DCA Owner BIC	Shows the BIC of the T2S party owning the Dedicated Cash Account. Only in case of settlement instructions against payment.

Report General Details	
Amount	<p>Cash amount failed to be delivered, and its corresponding currency.</p> <p>In case the instruction was partially settled at the moment of the end of cut-off processing used for the calculation of the SEFP, it is the remaining amount at that point in time.</p> <p>For LMFPs it is the matched amount.</p>
Credit/Debit	<p>It must be present when the Original Settlement Amount has a value.</p> <p>The possible values are:</p> <ul style="list-style-type: none"> <input type="checkbox"/> DBIT (Debit) <input type="checkbox"/> CRDT (Credit)
Acknowledged Status TS	Shows the Calendar Date when the acceptance (SF1) of the settlement instruction has occurred
Matched Status Timestamp	Shows the Calendar Date when the matching (SF2) of the settlement instruction has occurred
Failed Reason	<p>T2S sends this status when the Settlement Instruction has not been completely settled and the settlement is not possible at the Intended Settlement Date.</p> <p>It is only provided in case of 'SEFP'</p>
Additional Reason	<p>Shows the combination of the associated business rule and reason code reference,</p> <p>It is only provided in case of 'SEFP'</p>
BD Event Identification	<p>Shows the code identifying the event (i.e. Cut-off- Code identifying the event)</p> <p>It is only provided in case of 'SEFP'</p>
Scheme Name	<p>Shows the name of the scheme.</p> <p>Fixed content to 'EVTP'</p> <p>It is only provided in case of 'SEFP'</p>

Report General Details	
Issuer	Shows the entity assigning the identification. Fixed content to 'T2S' It is only provided in case of 'SEFP'
Scheduled Time	Shows the effective time for the schedule of the cut-off It is only provided in case of 'SEFP'
Start Time	Shows the effective time for the trigger of the cut-off It is only provided in case of 'SEFP'
End Time	Shows the effective time for the closure of the Cut-off It is only provided in case of 'SEFP'

2.4.1.23 Available Report – Monthly Aggregated Amounts – Details Screen

Context of Usage

This screen displays detailed information on the Monthly Aggregated Amounts report. The report displayed in this screen has to be already created in accordance with its report configuration. Hence, no new report will be created by entering this screen.

For large reports the user has the option to view them in portions of up to 500 penalties. Only the current portion of the report will be available for a downloading or for printing.

This screen is only available for CSD authorised users and T2S Operator user.

Screen Access

Services >> Additional Services >> Reports >> *Available reports – search/list* screen >> Click on the *search* and/or *details* button >> *Available report – details* screen >> Click on the *details* button

Privileges

To use this screen, you need the following privilege:

Report details query

References

User Instructions Part

This screen is part of the following business scenario:

View available reports

Business Functionality Document

This screen corresponds to the following business function:

- Display generated report details (T2S.GUI.INSE.RPT.0090)

Screenshot

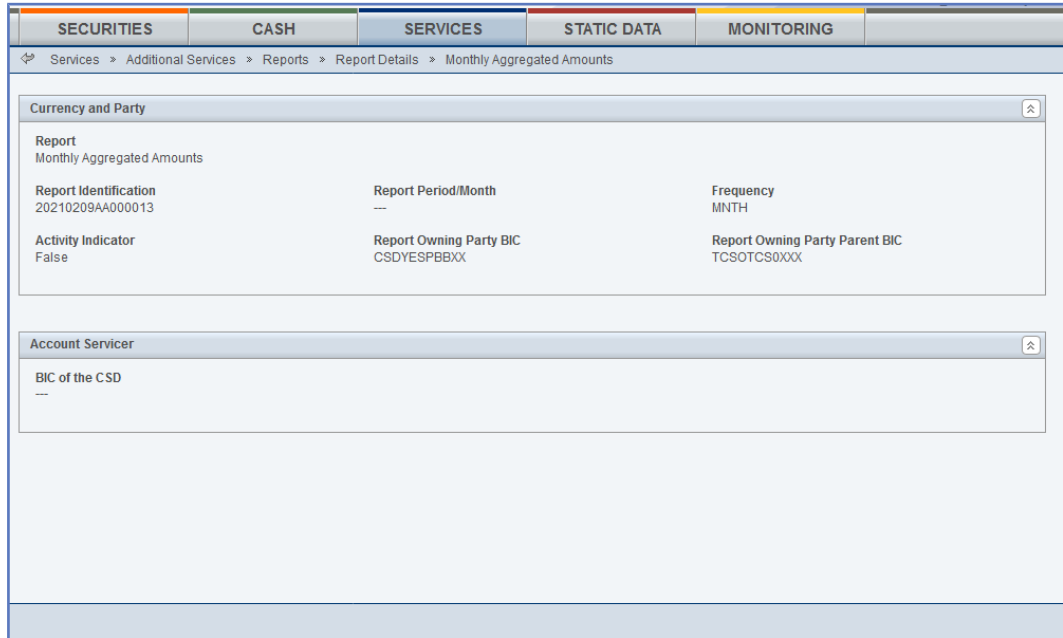

Illustration 115: Available report – monthly aggregated amounts – details screen

Field

Description

Report General Details	
Report	Shows the name of the report.
Report Identification	Shows the penalty number of the report composed of the business date and report types, sent in pull and push mode by T2S, and the sequential number, which is unique in T2S. The number increases for each report.
Report Period/Month	Shows the month reported (whose penalties
Frequency	Indicates the frequency of the generation of the report. The unique possible value is: <input type="checkbox"/> MNTH
Activity Indicator	Shows if the message contains records or not. The possible values are: <input type="checkbox"/> True

Report General Details	
	<input type="checkbox"/> False
Report Owning Party BIC	Shows the Party BIC whose data is reported on.
Report Owning Party Parent BIC	Shows the Party Parent BIC whose data is reported on.
Account Servicer	
BIC of the CSD	Shows the CSD of the participant whose penalties are reported in this message.
Currency and Party	
Currency	Shows the currency of the penalties reported.
Party BIC	Shows the BIC of the Party that manages the account on behalf of the party account owner.
Party Type	<p>Shows the Party Type of the Party according to T2S Reference Data.</p> <p>The possible values are:</p> <ul style="list-style-type: none"> <input type="checkbox"/> NCSD is provided when the CSD itself is the failing or non failing party of the penalty/claim. This is used to differentiate between the CSD and the CSD as participant of itself. It is needed because the AccountServicer/Depository of the party provided in the message is the BIC of the CSD of the party, not the parent BIC of the party. Consequently, without this additional identification, it won't be possible to distinguish between a CSD and the CSD as participant of itself. <input type="checkbox"/> CCPA is provided when the failing or non failing party of the penalty/claim is a CCP; i.e. In T2S this is done by checking if the party has a BIC in the Cash Penalties CCP List (list of BICs).

Report General Details	
	<ul style="list-style-type: none"> <input type="checkbox"/> CSDP is provided when the failing or non failing party of the penalty/claim is neither a CSD nor a CCP and its party type is CSD Participant. <input type="checkbox"/> EXTE is provided when the failing or non failing party of the penalty/claim is neither a CSD nor a CCP and its party type is an external CSD in T2S.
Counterparty	
BIC of the CSD of the counterparty	Shows the CSD of the counterparty of the penalties reported in this block of the message.
Counterparty BIC	Shows the BIC of the Party that manages the account on behalf of the counterparty account owner.
Counterparty Type	Shows the BIC of the Party that manages the account on behalf of the counterparty account owner. The possible values are: <ul style="list-style-type: none"> <input type="checkbox"/> NCSD <input type="checkbox"/> CCPA <input type="checkbox"/> CSDP <input type="checkbox"/> EXTE
Aggregated Amount	Shows the monthly aggregated net amount of all the penalties computed for the business days of the previous month, in the related currency for the relevant party and counterparty.
Credit/Debit	Shows whether the Monthly Aggregated Net Amount is due or to be received by the participant. The possible values are: <ul style="list-style-type: none"> <input type="checkbox"/> DBIT(Debit) <input type="checkbox"/> CRDT(Credit)

Report General Details	
	If no value is retrieve, it will show "---"
Penalty	
Common ID	Shows the reference assigned by T2S to the penalty that is common for both the failing and the non-failing participant.
Individual ID	Shows the reference assigned by T2S to the penalty that is the individual identification of the penalty for the relevant account owner.
Reallocation ID	Shows the Common Reference of either the penalty from which the reported penalty was re-allocated or the penalty to which the reported penalty has been re-allocated.
Type	Shows the type of the penalty. The possible values are: <input type="checkbox"/> SEFP <input type="checkbox"/> LMFP
Amount of the Penalty	Shows the amount computed for the penalty and its corresponding currency.
Credit/Debit Indicator	Shows whether the penalty is due or to be received by the participant. The possible values are: <input type="checkbox"/> DBIT(Debit) <input type="checkbox"/> CRDT(Credit)
Calculation Method	Shows the calculation method used to calculate the penalty. The possible values are: <input type="checkbox"/> SECU - The Penalty is based on the quantity of securities failed to be delivered and security penalty rate of the relevant Asset type.

Report General Details	
	<ul style="list-style-type: none"> <input type="checkbox"/> MIXE - The Penalty is based on the quantity of securities failed to be delivered and penalty rate is the discount rate of the relevant currency. <input type="checkbox"/> CASH - Penalty is based on the amount of cash failed to be delivered and the penalty rate is the discount rate of the relevant currency <input type="checkbox"/> BOTH - Penalty is the sum of "SECU" and "CASH".
Number of Days	Shows the number of business days the penalty is applicable to.

2.4.1.24 Data Changes - Search/List Screen

Context of Usage

This screen contains a number of search fields. By inputting the relevant data, you can search for all static and dynamic data changes which were initiated in 4-eyes mode. You can use this screen to search for items which are waiting for approval, select those and approve or revoke them.

The search results will be displayed in a list, which is sorted by the values of the column 'Update Date and Time' in descending order (default setting). After selecting an entry, you can proceed further by clicking on the buttons below.

This function is only available in U2A mode.

Screen Access

- Services >> Additional Services >> Data Changes
- Securities >> Settlement >> Data Changes
- Cash >> Liquidity >> Data Changes

Privileges

To use this screen you need the following privileges [▶ 1210]:

- Data changes of a business object list query
- Data changes of a business object details query

References

User Instructions Part

This screen is part of the following business scenarios:

- Initiate an action in 4-eyes mode
- Approve an action in 4-eyes mode

Business Functionality Document

This screen corresponds to the following business functions:

- Query data change approval requests (T2S.GUI.OSSE.APR.0010)
- Display data changes approval request list (T2S.GUI.OSSE.APR.0020)

Screenshot

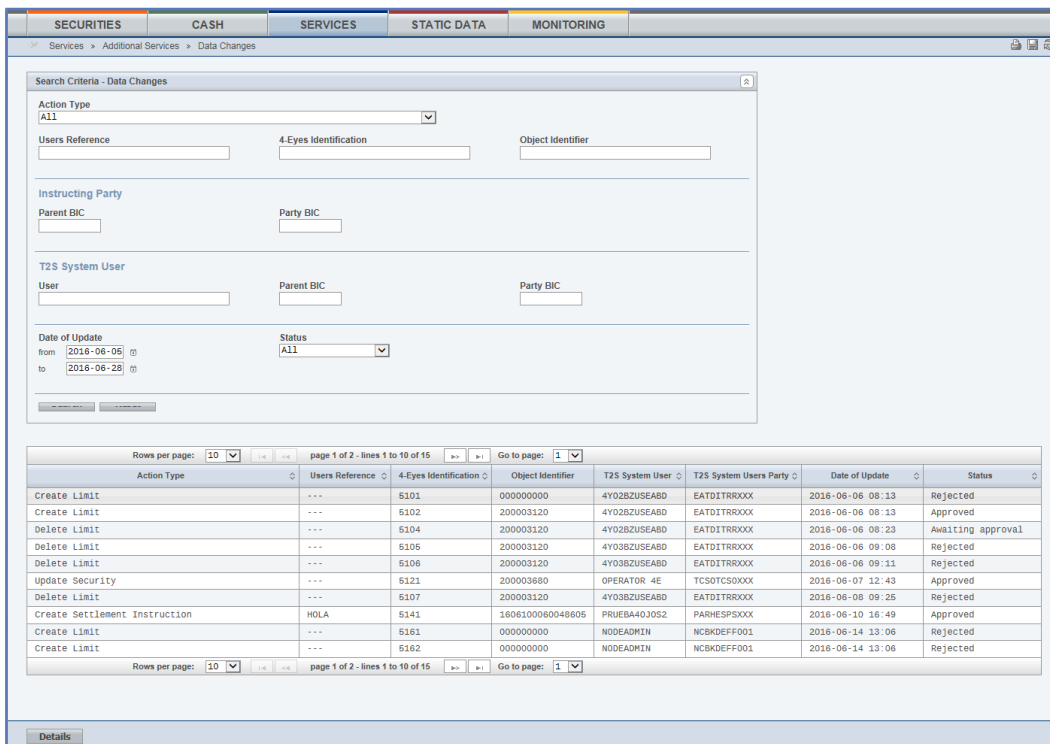

Illustration 116: Data changes – search/list screen

Field Description

Data Changes – Search Criteria	
Action Type	Select the type of action initiated by the first user for a dedicated static or dynamic data object from the possible values: <input type="checkbox"/> All <input type="checkbox"/> Each of the actions that can be done in 4-eyes-mode
Users Reference	Enter the identification the first user added to his request. Required format is: max. 35 characters (SWIFT-x)
4-Eyes Identification	Enter the identification of the data change, automatically assigned by T2S to an operation that has to be authorised by a second user. Required format is: max. 35 characters (SWIFT-x)
Object Identifier	Enter the object identifier of the added / changed / deleted object. It is the technical identifier of an object unless a business identifier is available for this object. Required format is: max. 35 characters (SWIFT-x)
Instructing Party	
Parent BIC	Enter the parent BIC of the instructing party.

Data Changes – Search Criteria	
	<p>Required format is: max. 11 characters (SWIFT-x)</p> <p>If the 'Party BIC' field is filled in, this field is mandatory.</p> <p>This field is only filled for requests to 'Life Cycle Management and Matching' in 4-eyes mode.</p>
Party BIC	<p>Enter the BIC of the instructing party.</p> <p>Required format is: max. 11 characters (SWIFT-x)</p> <p>If the 'Parent BIC' field is filled in, this field is mandatory.</p> <p>This field is only filled for requests to 'Life Cycle Management and Matching' in 4-eyes mode.</p>
Date of Update	
Date of Update - from	<p>Enter the lower bound of the date from which the data change was requested.</p> <p>Required format is: YYYY-MM-DD</p> <p>The default value is the current calendar date.</p> <p>References for error messages [▶ 1296]:</p> <ul style="list-style-type: none"> <input type="checkbox"/> QMPC015 <input type="checkbox"/> QMPC016
Date of Update - to	<p>Enter the upper bound of the date until which the data change was requested.</p> <p>Required format is: YYYY-MM-DD</p> <p>The default value is the current calendar date.</p> <p>Reference for error message [▶ 1296]:</p> <ul style="list-style-type: none"> <input type="checkbox"/> QMPC015
T2S System User	
User	<p>Enter the name of the last user who entered, edited or deleted the static or dynamic data.</p>
Party BIC	<p>Enter the BIC of the party which the last user belongs to.</p> <p>Required format is: max. 11 characters (SWIFT-x)</p> <p>If the 'Parent BIC' field is filled in, this field is mandatory.</p>
Parent BIC	<p>Enter the parent BIC of the party which the last user belongs to.</p> <p>Required format is: max. 11 characters (SWIFT-x)</p> <p>If the 'Party BIC' field is filled in, this field is mandatory.</p>

Data Changes – Search Criteria	
Status	<p>Select the processing status of the data change from the possible values:</p> <ul style="list-style-type: none"> <input type="checkbox"/> All (Default value) <input type="checkbox"/> Awaiting approval <input type="checkbox"/> Queued <input type="checkbox"/> Approved <input type="checkbox"/> Rejected <input type="checkbox"/> Revoked
Data Changes - List	
Action Type	Shows the type of action, from all the actions that can be done in 4-eyes-mode, initiated by the first user for a dedicated static or dynamic data object.
Users Reference	Shows the identification by the first user added to his request.
4-Eyes Identification	Shows the identification of the change automatically assigned by T2S to an operation that has to be authorised by a second user.
Object Identifier	Shows the object identification returned by the subsequent module after successful business validation. This information will not be displayed for all records.
T2S System User	Shows the name of the last user who entered, edited or deleted the static or dynamic data.
T2S System User Party	Shows the BIC of the party which the last user belongs to.
Update Date and Time	<p>Shows the timestamp when the first user entered, edited or deleted the static or dynamic data.</p> <p>Displayed format is: YYYY-MM-DD hh:mm:ss:µsµsµsµsµs</p>
Status	<p>Shows the status of the data change from the possible values:</p> <ul style="list-style-type: none"> <input type="checkbox"/> Awaiting approval <input type="checkbox"/> Queued <input type="checkbox"/> Approved <input type="checkbox"/> Rejected <input type="checkbox"/> Revoked

Buttons

Search	<p>This function enables you to start a search according to the criteria entered. The results are displayed in a list on the same screen.</p> <p>If the search retrieves only one record, the <i>details</i> screen is displayed directly.</p> <p>Next screens:</p> <ul style="list-style-type: none"><input type="checkbox"/> <i>Data changes – search/list</i> screen<input type="checkbox"/> <i>Data change – details</i> screen [▶ 612] <p>References for error messages [▶ 1296]:</p> <ul style="list-style-type: none"><input type="checkbox"/> QMPC015<input type="checkbox"/> QMPC016
Reset	<p>This function enables you to set default search criteria and blanks out all optional criteria.</p> <p>Next screen:</p> <ul style="list-style-type: none"><input type="checkbox"/> <i>Data changes – search/list</i> screen
Details	<p>This function enables you to display the details of the selected data change.</p> <p>Next screen:</p> <ul style="list-style-type: none"><input type="checkbox"/> <i>Data change – details</i> screen [▶ 612]

2.4.1.25 Data Change - Details Screen

Context of Usage

This screen displays detailed information on the selected static or dynamic data changes, changes are highlighted in red. You can check the data and proceed further by clicking on the buttons below.

You can use this screen for approving/revoking static and dynamic data changes and to see details of already approved/revoked items.

This function is only available in U2A mode.

Screen Access

- Services >> Additional Services >> Data Changes >> *Data changes – search/list* screen >> Click on the *search* and/or *details* button
- Securities >> Settlement >> Data Changes >> *Data changes – search/list* screen >> Click on the *search* and/or *details* button
- Cash >> Liquidity >> Data Changes >> *Data changes – search/list* screen >> Click on the *search* and/or *details* button

Privileges

To use this screen, you need the following privileges [▶ 1210]:

- Data changes of a business object details query

- Data changes of a business object list query

References

User Instructions Part

This screen is part of the following business scenarios:

- Initiate an action in 4-eyes mode
- Approve an action in 4-eyes mode

Business Functionality Document

This screen corresponds to the following business functions:

- Display data change approval request details (T2S.GUI.OSSE.APR.0030)
- Data change approval request confirmation (T2S.GUI.OSSE.APR.0040)

Screenshot

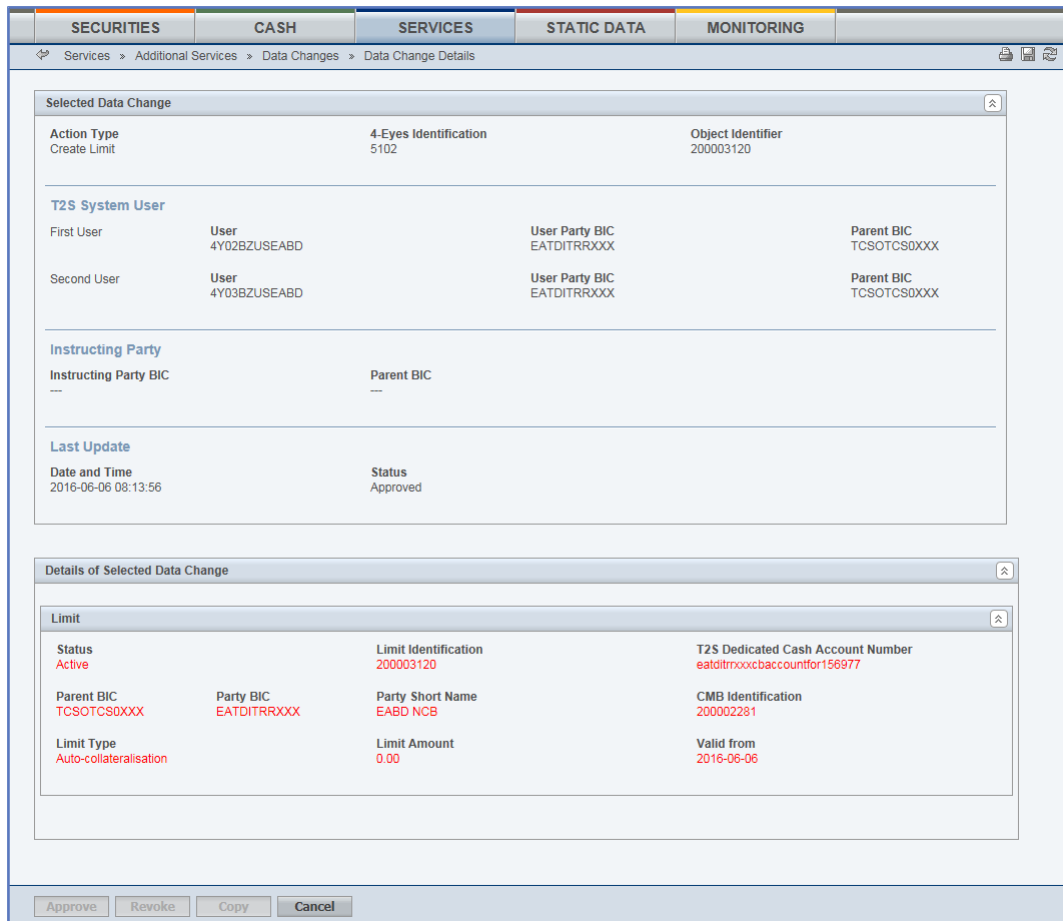

Illustration 117: Data change – details screen

Field

Description

Selected Data Change	
Action Type	Shows the type of action initiated by the first user.
Users Reference	Shows the identification the first user added to his request.
4-Eyes Identification	Shows the identification assigned by T2S to an operation that has to be approved by a second user.

Selected Data Change	
Object Identifier	Shows the object identification of the static or dynamic data object returned by the subsequent module after a successful business validation. The object identifier includes the technical identification of the added, changed or deleted object. The object identification is not available for 'Life Cycle Management and Matching' data changes.
Instructing Party	
Instructing Party BIC	Shows the BIC of the instructing party. This field is only filled for requests to 'Life Cycle Management and Matching' in 4-eyes mode.
Parent BIC	Shows the parent BIC of the instructing party. This field is only filled for requests to 'Life Cycle Management and Matching' in 4-eyes mode.
Date and Time	Shows the timestamp when the user has entered the data. Displayed format is: YYYY-MM-DD hh:mm:ss:µsµsµsµsµs
T2S System User – First User	
User	Shows the name of the first user who entered, edited or deleted the static or dynamic data.
User Party BIC	Shows the BIC of the party which the first user belongs to.
Parent BIC	Shows the parent BIC of the party which the first user belongs to.
T2S System User – Second User	
User	Shows the name of the second user who entered, edited or deleted the static or dynamic data.
User Party BIC	Shows the BIC of the party which the second user belongs to.
Parent Party	Shows the parent BIC of the party which the second user belongs to.
Status	Shows the processing status of the data change from the possible values: <input type="checkbox"/> Awaiting approval <input type="checkbox"/> Queued <input type="checkbox"/> Approved <input type="checkbox"/> Rejected

Selected Data Change	
	<input type="checkbox"/> Revoked
Details of Selected Data Change	
Shows a preview of the <i>details</i> screen of the object you are e.g. creating or editing.	
If the action type is set to 'New Data', this frame shows the new values which will be active after the second user approves the change.	
If the action type is set to 'Edit Data', this frame shows the newly changed values marked in a different colour.	
If the action type is set to 'Delete Data', this frame shows the currently active values which will be deleted after the second user approves the change.	
Immediate Liquidity Transfer (example)	
Debit Cash Account	
Account Number*	Shows the T2S dedicated cash account to be debited.
Account Owner*	Shows the name of the account owner.
Liquidity Transfer	
User Reference*	Shows the identification of the liquidity transfer assigned by the T2S actor.
Amount*	Shows the amount of the initiated Immediate Liquidity Transfer.
Credit Cash Account	
Outbound Liquidity Transfer	Shows that the immediate liquidity transfer is an outbound liquidity transfer, if the radio button is checked.
Internal Liquidity Transfer	Shows that the immediate liquidity transfer is an internal liquidity transfer, if the radio button is checked.
RTGS Account*	Shows the cash account to be credited for the outbound liquidity transfer. If the immediate liquidity transfer is an 'Internal Liquidity Transfer', this field is not filled and greyed out.
Account Number*	Shows the cash account to be credited for the internal liquidity transfer. If the immediate liquidity transfer is an 'Outbound Liquidity Transfer', this field is not filled and greyed out.
List of Modifications	
The List of Modifications may contain several entries	

Selected Data Change	
Field Name	Name of the field, where the first user has changed data, entered new data or deleted data.
Old value	The old value is the currently active value of the field before the second user approves the changes.
New value	The new value is the pending value of the field which will be active, after the second user approved the changes.

Buttons

Approve	<p>This function enables you to approve the action initiated by the first user. In case non-repudiation of origin is required: Upon clicking on the <i>approve</i> button you will be asked to enter your PIN for digital signature purposes (NRO). With the entry of the PIN, T2S attaches a digital signature to the instruction entered by the T2S actor.</p> <p>Next screen:</p> <ul style="list-style-type: none"> <input type="checkbox"/> <i>Data changes – search/list</i> screen [▶ 608] <p>This function is only available if the processing status of the data change is set to 'Awaiting Approval' and the T2S system user has the necessary privileges.</p>
Revoke	<p>This function enables you to revoke the action initiated by the first user. In case non-repudiation of origin is required: Upon clicking on the <i>revoke</i> button you will be asked to enter your PIN for digital signature purposes (NRO). With the entry of the PIN, T2S attaches a digital signature to the instruction entered by the T2S actor.</p> <p>Next screen:</p> <ul style="list-style-type: none"> <input type="checkbox"/> <i>Data changes – search/list</i> screen [▶ 608] <p>This function is only available if the processing status of the data change is set to 'Awaiting Approval' and the T2S system user has the necessary privileges.</p>
Copy	<p>This function enables you to copy fields to create a new data change with the same attributes.</p>

	<p>Next screen:</p> <ul style="list-style-type: none"> <input type="checkbox"/> <i>Respective new/edit</i> screen (filled with the values formerly entered by the first user.) <p>This function is only available if the processing status of the data change is set to 'Revoked' or 'Rejected'.</p>
Cancel	<p>This function enables you to cancel the process and return to the previous screen.</p> <p>Next screen:</p> <ul style="list-style-type: none"> <input type="checkbox"/> <i>Data changes – search/list</i> screen [▶ 608]

2.4.2 Communication

2.4.2.1 Broadcast - Search/List Screen

Context of Usage

This screen contains a number of search fields. By inputting the relevant data, you can search for sent and received broadcasts. The search result will be displayed in a list, which is sorted by the values of the 'Creation Date and Time' column in descending order (default setting). After selecting an entry, you can proceed further by clicking on the buttons below.

When exporting the content of this screen, you receive the list and the corresponding details for each data record.

This function is only available in U2A mode.

There is no usage restriction for this screen.



Hint

A user may only view broadcasts until their validity elapses. The respective expiration date is automatically set to the current business date of creation + three business days.

Screen Access

Services >> Communication >> Broadcasts

Privileges

To use this screen, you need the following privilege [▶ 1206]:

- Broadcast query
- New broadcast

References

User Instructions Part

This screen is part of the following business scenarios:

- Create a new broadcast [▶ 706]

View a broadcast [▶ 707]

Business Functionality Document

This screen corresponds to no business function.

Screenshot

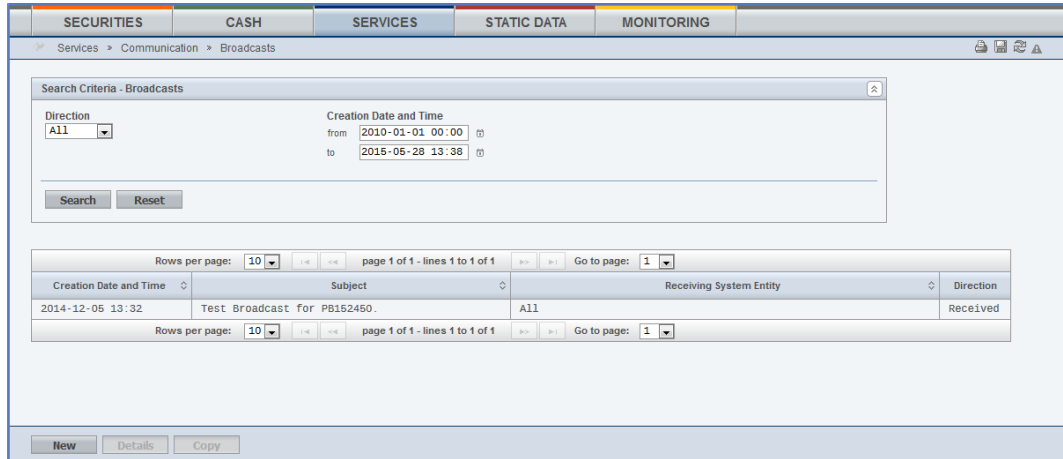

Illustration 118: Broadcasts - search/list screen

Field

Description

Broadcasts – Search Criteria	
Direction*	<p>Select the information about the direction of the broadcast from the possible values:</p> <ul style="list-style-type: none"> <input type="checkbox"/> All (default value) <input type="checkbox"/> Sent <input type="checkbox"/> Received
Creation Date and Time from	<p>Enter the lower bound of the search range for the date and time from which the broadcasts shall be displayed or use the <i>calendar</i> icon.</p> <p>Required format is: YYYY-MM-DD hh:mm:ss</p> <p>The 'Creation Date and Time from' has to be a valid calendar date and time.</p> <p>Reference for error message [▶ 1285]:</p> <ul style="list-style-type: none"> <input type="checkbox"/> QMPC015
Creation Date and Time to*	<p>Enter the upper bound of the search range for the date and time until which the broadcasts shall be displayed or use the <i>calendar</i> icon.</p> <p>The default value is the current calendar date and time. In case the 'Creation Date and Time to' is removed the search will be executed with the default value.</p> <p>Required format is: YYYY-MM-DD hh:mm:ss</p> <p>The 'Creation Date and Time to' has to be a valid calendar date and time.</p>

Broadcasts – Search Criteria	
	Reference for error message [▶ 1285]: <input type="checkbox"/> QMPC015
Broadcasts - List	
Creation Date and Time	Shows the creation date and time when the broadcasts was posted. Displayed format is: YYYY-MM-DD hh:mm:ss:µsµsµsµsµs
Subject	Shows the title of the broadcast.
Direction	Shows detailed information about the direction from the possible values: <input type="checkbox"/> All <input type="checkbox"/> Sent <input type="checkbox"/> Received
Receiving Party BIC	This function enables you to start a search according to the criteria entered. The results are displayed in a list on the same screen. If the search retrieves a single record, the details screen is displayed. Next screen: <input type="checkbox"/> Broadcasts – search/list screen <input type="checkbox"/> Broadcast – details screen [} 179] Reference for error message: <input type="checkbox"/> QMPC015

Buttons

Reset	This function enables you to set default search criteria and blanks out all optional criteria. Next screen: <i>Broadcasts – search/list</i> screen
Details	This function enables you to display details of the selected broadcast. Next screen: <i>Broadcast – details</i> screen [▶ 620]
New	This function enables you to create a new broadcast.

	Next screen: <i>Broadcast – new screen</i> [▶ 622]
Copy	This function enables you copy fields to create a new broadcast with the same attributes. Next screen: <i>Broadcast – new screen</i> [▶ 622]

2.4.2.2 Broadcast - Details Screen

Context of Usage

This screen displays detailed information on the selected broadcast. You can check the data and proceed further by clicking on the buttons below.

This function is only available in U2A mode.

There is no usage restriction for this screen.

Screen Access

□ Services >> Communication >> Broadcasts >> *Broadcasts – search/list* screen >> Click on the *details* button

□ Services >> Communication >> Broadcasts >> *Broadcasts – search/list* screen >> Click on the *search* button

Privileges

To use this screen, you need the following privilege [▶ 1205]:

□ Broadcast query

References

User Instructions Part

This screen is part of the following business scenario:

□ View a broadcast [▶ 707]

Business Functionality Document

This screen corresponds to no business function.

Screenshot

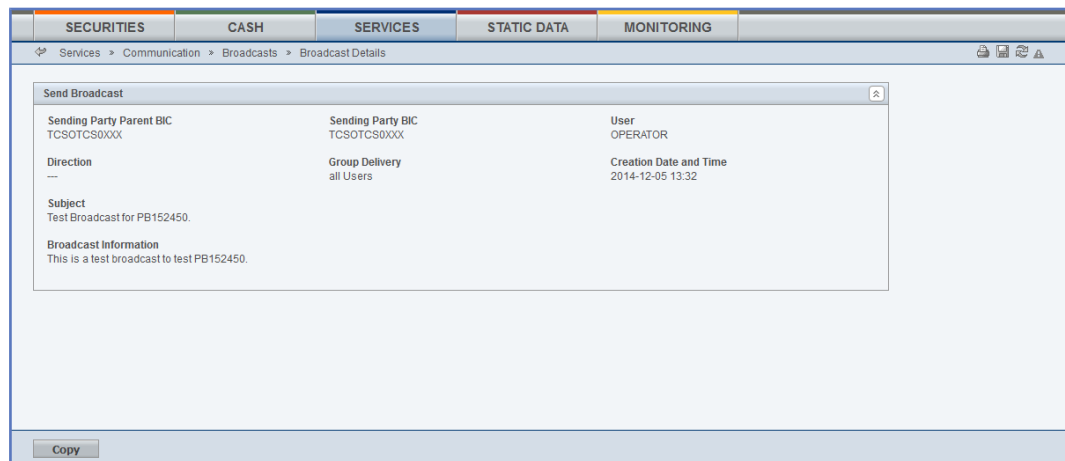

Illustration 119: Broadcast – details screen

Field
Description

Broadcast – Details	
Sending Party Parent BIC	Shows the parent BIC of the sending party.
Sending Party BIC	Shows the BIC of the sending party.
User	Shows the initiating T2S system user.
Direction	Shows whether the broadcast status is received, sent or both from of possible values: <input type="checkbox"/> Received <input type="checkbox"/> Sent
Group Delivery	Shows the group which the broadcast has been delivered to.
Creation Date and Time	Shows the creation date and time of the broadcast. Displayed format is: YYYY-MM-DD hh:mm:ss:µsµsµsµsµsµs
Subject	Shows the title of the broadcast.
Broadcast Information	Shows the detailed content of the broadcast.

Buttons

Copy	This function enables you copy fields to create a new broadcast with the same attributes. Next screen: <input type="checkbox"/> <i>Broadcast – new screen</i> [▶ 622]
------	--

2.4.2.3 Broadcast - New Screen

Context of Usage

This screen contains a number of fields regarding broadcasts. You can enter new data. Afterwards you can proceed further by clicking on the buttons below and send manual broadcasts to your CB/CSD and, all parties in your hierarchy.

This function is only available in U2A mode.

There is no usage restriction for this screen.

Screen Access

- Services >> Communication >> Broadcasts >> *Broadcast – search/list* screen >> Click on the *new* button
- Services >> Communication >> Broadcasts >> *Broadcast – search/list* screen >> Click on the *copy* button
- Services >> Communication >> Broadcasts >> *Broadcasts – search/list* screen >> Click on the *search* and/or *details* button >> *Broadcast – details* screen >> Click on the *copy* button

Privileges

To use this screen, you need the following privilege [[▶ 1205](#)]:

- New broadcast

References

User Instructions Part

This screen is part of the following business scenario:

- Create a new broadcast [[▶ 706](#)]

Business Functionality Document

This screen corresponds to no business function.

Screenshot

Illustration 120: Broadcast - new screen

Field Description

Broadcast - New	
Group Delivery*	Shows the receiving party: <ul style="list-style-type: none"> <input type="checkbox"/> This field is always filled in with 'Single <input type="checkbox"/> CB/CSD and parties in its hierarchy

Broadcast - New	
Subject*	Enter the title of the broadcast. Required format is: max. 50 characters (SWIFT-x)
Text*	Enter the message content of the broadcast. Required format is: max. 1000 characters (SWIFT-x)

Buttons

Buttons	
Submit	This function enables you to create a new broadcast. Upon clicking on the <i>submit</i> button you will be asked to enter your PIN for digital signature purposes (NRO). With the entry of the PIN, T2S attaches a digital signature to the instruction entered by the T2S actor. Next screen: <input type="checkbox"/> <i>Broadcast – new</i> screen
Reset	This function enables you to set all fields to default value and blanks out all optional fields. Next screen: <input type="checkbox"/> <i>Broadcast – new</i> screen
Cancel	This function enables you to cancel the process and return to the previous screen. Next screen: <input type="checkbox"/> <i>Broadcasts – search/list</i> screen [▶ 617]

2.4.2.4 Inbound Files - Search/List Screen

Context of Usage

This screen contains a number of search fields. By inputting the relevant data, you can search for inbound files. The search results will be displayed in a list, which is sorted by the values of the 'Entry Date and Time' column in descending order (default setting). After selecting an entry, you can proceed further by clicking on the buttons below. Users can see Inbound Messages under their data-scope.

This function is only available in U2A mode.

There is no usage restriction for this screen.

Screen Access

- Services >> Communication >> Inbound Files

Privileges

To use this screen, you need the following privilege [▶ 1214]:

- Inbound files list query

References

User Instructions Part

This screen is part of the following business scenario:

- View inbound communication [▶ 709]

Business Functionality Document

This screen corresponds to the following business functions:

- Query inbound file (T2S.GUI.CCSE.FIL.0010)
- Display inbound file list (T2S.GUI.CCSE.FIL.0020)

Screenshot

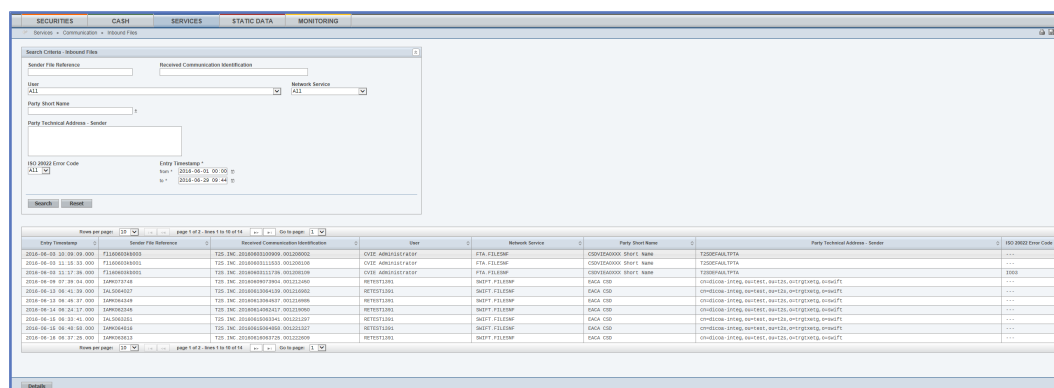

Illustration 121: Inbound files – search/list screen

Field Description

Inbound Files – Search Criteria	
Sender File Reference	Enter the identification of the original file containing the messages. Required format is: max. 35 characters (SWIFT-x)
Received Communication	Enter the internal identification for the inbound communication assigned by T2S. Required format is: max. 50 characters (SWIFT-x)
User	Enter or select the user who initiated the communication under the data scope of the requestor. Required format is: max. 35 characters. All available users which you are privileged to see are listed.
Network Service	Select the network service from the drop-down menu.
Sending Party Short Name	Enter or select the short name of the business sending party under the data scope of the requestor. Required format is: max. 35 characters. All available sending parties which you are privileged to see are listed.
Party Technical Address	Enter the technical address (i.e. distinguished name) of the party.

Inbound Files – Search Criteria	
	Required format is: max. 256 characters in UTF-8 except '<' ;>'&'
ISO 20022 Error Code	Select the error code for rejection from the drop-down menu.
Entry Date and Time from*	<p>Enter the lower bound of the search range for the calendar date and time from which the inbound file entered the system or use the <i>calendar</i> icon.</p> <p>Required format is: YYYY-MM-DD hh:mm:ss</p> <p>Default value is the current calendar date and time.</p> <p>The 'Entry Date and Time from' date must be earlier than or equal to the current business date and earlier than the 'Entry Date and Time to' date.</p> <p>References for error messages: [▶ 1320]</p> <ul style="list-style-type: none"> <input type="checkbox"/> QMPC015 <input type="checkbox"/> QMPC073
Entry Date and Time to*	<p>Enter the upper bound of the search range for the calendar date and time until which the inbound file entered the system or use the <i>calendar</i> icon.</p> <p>Required format is: YYYY-MM-DD hh:mm:ss</p> <p>Default value is the current calendar date and time.</p> <p>The 'Entry Date and Time to' date must be later than the 'Entry Date and Time from' date.</p> <p>Reference for error message: [▶ 1320]</p> <ul style="list-style-type: none"> <input type="checkbox"/> QMPC015
Inbound Files – List	
Repetitive block for each business object of an inbound file	
Entry Date and Time	<p>Shows the calendar date and time when the inbound file entered T2S.</p> <p>Displayed format is: YYYY-MM-DD hh:mm:ss:μsμsμsμsμs</p>
Sender File Reference	Shows the identification of the original file.
Received Communication	Shows the internal identification for the inbound communication assigned by T2S.
User	Shows the user who initiated the communication.
Network Service	Shows the name of the network service.

Inbound Files – Search Criteria	
Sending Party Short Name	Shows the short name of the business sending party.
Party Technical Address	Shows the technical address (i.e. distinguished name) of the party. Displayed format is: max. 256 characters in UTF-8 except '<' ;'>','&'
ISO20022 Error Code	Shows the error code for the rejection. In case of more than one error, this field shows 'various'.

Buttons

Search	<p>This function enables you to start a search according to the criteria entered. The results are displayed in a list on the same screen.</p> <p>If the search retrieves a single record, the <i>details</i> screen is displayed directly.</p> <p>Next screens:</p> <ul style="list-style-type: none"> <input type="checkbox"/> <i>Inbound files – search/list</i> screen <input type="checkbox"/> <i>Inbound file – details</i> screen [▶ 626] <p>References for error messages: [▶ 1320]</p> <ul style="list-style-type: none"> <input type="checkbox"/> QMPC015 <input type="checkbox"/> QMPC073
Reset	<p>This function enables you to set default search criteria and blanks out all optional criteria.</p> <p>Next screen:</p> <ul style="list-style-type: none"> <input type="checkbox"/> <i>Inbound files – search/list</i> screen
Details	<p>This function enables you to display the details of the selected inbound file.</p> <p>Next screen:</p> <ul style="list-style-type: none"> <input type="checkbox"/> <i>Inbound file – details</i> screen [▶ 626]

2.4.2.5 Inbound File - Details Screen

Context of Usage

This screen displays detailed information on the selected inbound file. You can check the data and proceed further by clicking on the button below.

There is no usage restriction for this screen.

This function is only available in U2A mode.

Screen Access

- Services >> Communication >> Inbound Files >> *Inbound files – search/list* screen >> Click on the *search* and/or *details* button
- Services >> Communication >> Inbound Messages >> *Inbound messages – search/list* screen >> Click on the *inbound file* button
- Services >> Communication >> Inbound Messages >> *Inbound messages – search/list* screen >> Click on the *search* and/or *details* button >> *Inbound message – details* screen >> Click on the *inbound file* button

Privileges

To use this screen, you need the following privilege [[▶ 1214](#)]:

- Inbound files details query

References

User Instructions Part

This screen is part of the following business scenario:

- View inbound communication [[▶ 709](#)]

Business Functionality Document

This screen corresponds to the following business functions:

- Display inbound file details (T2S.GUI.CCSE.FIL.0030)

Screenshot

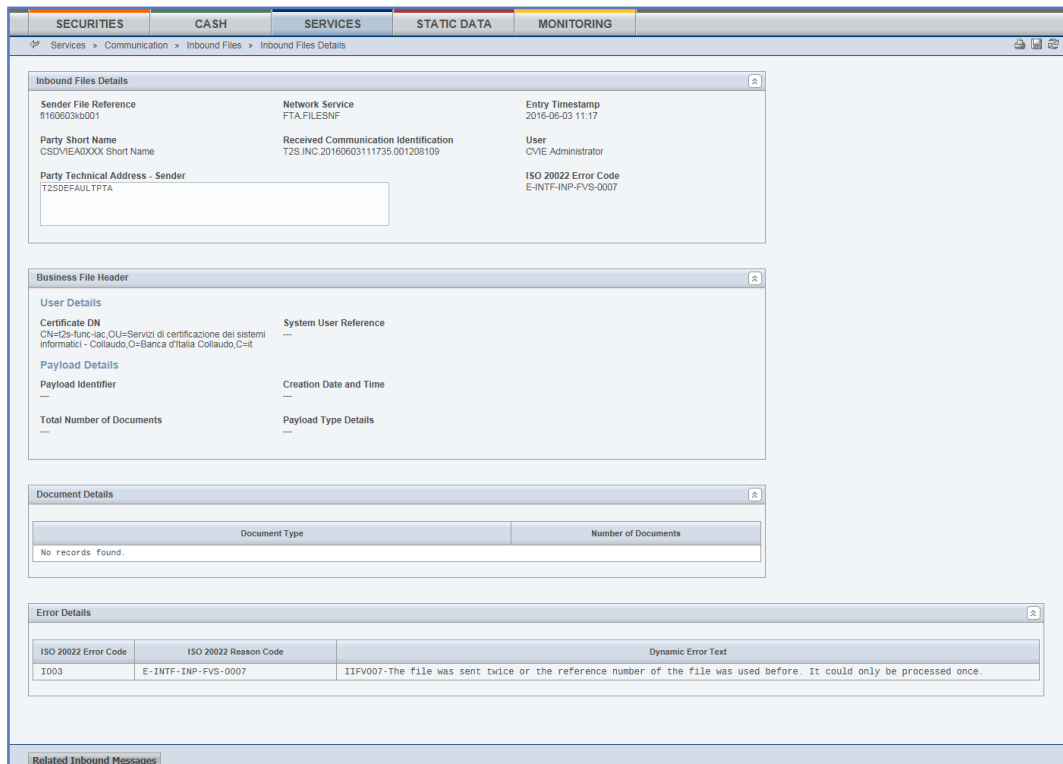

Illustration 122: Inbound file - details screen

Field Description

Inbound Files Details Information	
Sender File Reference	Shows the identification of the original file containing the messages.

Inbound Files Details Information	
Network Service	Shows the name of the network service.
Entry Date and Time	Shows the calendar date and time when the file entered T2S. Displayed format is: YYYY-MM-DD hh:mm:ss:µsµsµsµsµs
Sending Party Short Name	Shows the short name of the business sending party.
Received Communication	Shows the identification for the inbound communication assigned by T2S.
User	Shows the user who initiated the communication.
Party Technical Address	Shows the technical address (i.e. distinguished name) of the party.
ISO 20022 Error Code	Shows the ISO 20022 error code.
Business File Header	
User Information	
Certificate Distinguished Name	Shows the user information which was extracted from the signature tag in the file header.
System User Reference	Shows the identification of the system user which was extracted from the file header.
Payload Details	
Payload Identifier	Shows the identification of the file which was assigned by the sender of the file.
Creation Date and Time	Shows the date and time when the file was created by the sender. Displayed format is: YYYY-MM-DD hh:mm:ss:µsµsµsµsµs
Total Number of Documents	Shows the total number of messages within the file.
Payload Type Details	Shows the identification of the payload type and the declaration of the payload content.
Document Details	
(Repetitive block for each business object of an inbound file)	
Document Type	Shows the type of the document as specified in the ISO 20022 message type catalogue.
Number of Documents	Shows the number of messages for each declared type.

Inbound Files Details Information	
Error Details	
(Repetitive block for each message of an inbound file)	
ISO 20022 Error Code	Shows the error code for the rejection.
ISO 20022 Reason Code	Shows the reason code for the rejection.
Dynamic Error Text	Shows a detailed error text explaining why the file was rejected.

Buttons

Buttons	
Related Inbound Messages	<p>This function enables you to display the inbound messages related to the selected inbound file.</p> <p>Next screens:</p> <ul style="list-style-type: none"> <input type="checkbox"/> <i>Inbound messages – search/list</i> screen [▶ 629] (if the inbound file is linked to more than 1 inbound message) <input type="checkbox"/> <i>Inbound message – details</i> screen [▶ 636] (if the inbound file is linked to 1 inbound message only)

2.4.2.6 Inbound Messages - Search/List Screen

Context of Usage

This screen contains a number of search fields. By inputting the relevant data, you can search for inbound messages. The search results will be displayed in a list, which is sorted by the values of the 'Entry Date and Time' column in descending order (default setting). After selecting an entry, you can proceed further by clicking on the buttons below. Users can see Inbound Messages under their datascopes.

This screen shows all inbound messages irrespective of whether they were sent via file or as single message.

There is no usage restriction for this screen.

This function is only available in U2A mode.

Screen Access

- Services >> Communication >> Inbound Message
- Services >> Communication >> Inbound Files >> *Inbound files – search/list* screen >> Click on the *search* and/or *details* button >> *Inbound file – details* screen >> Click on the *related inbound messages* button
- Cash >> Liquidity >> Immediate Liquidity Transfers >> *Immediate liquidity transfers – search/list* screen >> Click on the *related inbound messages* button

- Cash >> Liquidity >> Immediate Liquidity Transfers >> *Immediate liquidity transfers – search/list* screen >> Click on the *search* and/or *details* button >> *Immediate liquidity transfer – details* screen >> Click on the *related inbound messages* button
- Cash >> Settlement >> Intra-Balance Movement >> *Intra-balance movements with current and historical status – search* screen >> Click on the *search* button >> *Intra-balance movements - list* screen >> Click on the *details* button >> *Intra-balance movement – details* screen >> Click on the *related inbound message* button
- Cash >> Settlement >> Maintenance Cash Instructions >> *Maintenance cash instructions – search* screen >> Click on the *search* button >> *Maintenance cash instructions - list* screen >> Click on the *details* button >> *Amendment cash instruction - details* screen >> Click on the *related inbound message* button
- Cash >> Settlement >> Maintenance Cash Instructions >> *Maintenance cash instructions – search* screen >> Click on the *search* button >> *Maintenance cash instructions – list* screen >> Click on the *details* button >> *Cancellation cash instruction - details* screen >> Click on the *related inbound message* button
- Security >> Settlement >> Intra-Position Movement >> *Intra-position movements with current and historical status – search* screen >> Click on the *search* button >> *Intra-position movements - list* screen >> Click on the *details* button >> *Intra-position movement – details* screen >> Click on the *related inbound message* button
- Securities >> Settlement >> Maintenance Securities Instructions >> *Maintenance securities instructions – search* screen >> Click on the *search* button >> *Maintenance securities instruction - list* screen >> Click on the *details* button >> *Amendment securities instruction - details* screen >> Click on the *related inbound message* button
- Securities >> Settlement >> Maintenance Securities Instructions >> *Maintenance securities instructions – search* screen >> Click on the *search* button >> *Maintenance securities instructions – list* screen >> Click on the *details* button >> *Cancellation securities instruction - details* screen >> Click on the *related inbound message* button
- Securities >> Settlement >> Maintenance Securities Instructions >> *Maintenance securities instructions – search* screen >> Click on the *search* button >> *Maintenance securities instructions – list* screen >> Click on the *details* button >> *Hold/release instruction - details* screen >> Click on the *related inbound message* button

- Securities >> Settlement >> Settlement Instructions>> **Settlement Instructions – search** screen >> Click on the **search** button >> **Settlement instructions - list** screen >> Click on **details** button >> **Settlement instruction - details** screen >> Click on the **related inbound messages** button

Privileges

To use this screen, you need the following privilege [▶ 1215]:

- Inbound message list query

References

User Instructions Part

This screen is part of the following business scenario:

- View inbound communication [▶ 709]

Business Functionality Document

This screen corresponds to the following business functions:

- Query messages (T2S.GUI.CCSE.MSG.0010)
- Query inbound file (T2S.GUI.CCSE.FIL.0010)
- Display message list (T2S.GUI.CCSE.MSG.0020)

Screenshot

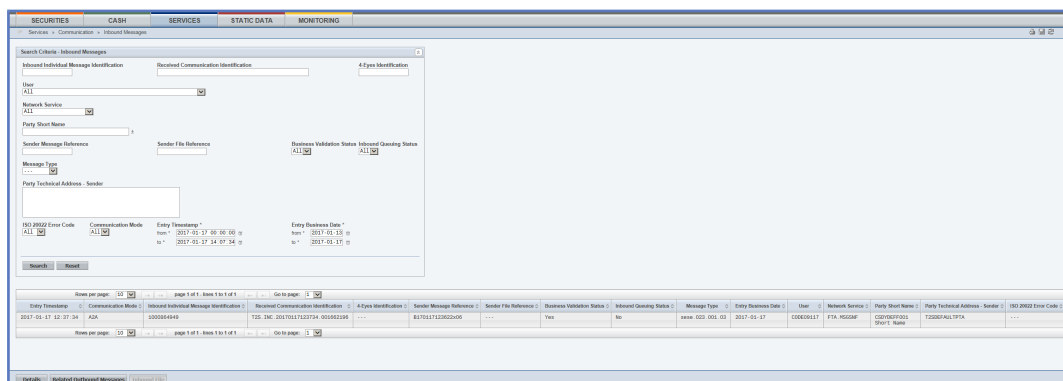

Illustration 123: Inbound messages – search/list screen

Field Descriptions

Inbound Messages – Search Criteria	
Inbound Individual Message	Enter the identification of the inbound individual message. Required format is: Integer
Received Communication Identification	Enter the technical identification for the inbound communication assigned by T2S. Required format is: max. 50 characters (SWIFT-x)
4-Eyes Identification	Enter the identification of the 4-eyes mode. Required format is: Integer
User	Enter or select the user who initiated the communication under the data scope of the requestor. Required format is: max. 35 characters. All available users which you are privileged to see are listed.

Inbound Messages – Search Criteria	
Network Service	Select the network service from the drop-down menu.
Sending Party Short Name	Select the short name of the sending party from the drop-down menu. All available sending parties which you are privileged to see are listed.
Sender Message Reference	Enter the identification of the original message as sent in the business application header. Required format is: max. 35 characters (SWIFT-x)
Sender File Reference	Enter the identification of the original file containing the message(s). Required format is: max. 35 characters (SWIFT-x)
Business Validation Status*	Select the status of the business validation from the possible values: <input type="checkbox"/> True (business validation completed) <input type="checkbox"/> False (business validation incomplete) <input type="checkbox"/> All (default value)
Inbound Queuing Status*	Select the status of the inbound queuing from the possible values: <input type="checkbox"/> True (request is currently queued) <input type="checkbox"/> False (request is not queued) <input type="checkbox"/> All (default value)
Message Type	Select the request type for the message according to ISO 20022 standards from the drop-down menu.
Party Technical Address - Sender	Enter the technical address (i.e. distinguished name) of the sending party. Required format is: max. 256 characters in UTF-8 except '<'; '>'; '&'
ISO 20022 Error Code	Select the error code for the rejection from the drop-down menu.
Communication Mode*	Select the mode of communication from the possible values: <input type="checkbox"/> A2A <input type="checkbox"/> U2A <input type="checkbox"/> All (default value)

Inbound Messages – Search Criteria	
Entry Date and Time from(*)	<p>Enter the lower bound of the search range for the calendar date and time of the system entry of the inbound message or use the <i>calendar</i> icon.</p> <p>Required format is: YYYY-MM-DD hh:mm:ss</p> <p>Default value is the current date and time – start of real-time settlement if the ‘Inbound Individual Message’ or the ‘Received Communication Identification’ is not populated from the previous screen.</p> <p>The ‘Entry Date and Time from’ date must be earlier than or equal to the current business date and earlier than the ‘Entry Date and Time to’ date.</p> <p>Reference for error message: [▶ 1321]</p> <p><input type="checkbox"/> QMPC015</p>
Entry Date and Time to(*)	<p>Enter the upper bound of the search range for the calendar date and time of the system entry of the inbound message or use the <i>calendar</i> icon.</p> <p>Required format is: YYYY-MM-DD hh:mm:ss</p> <p>Default value is the current date and time if the ‘Inbound Individual Message’ or the ‘Received Communication Identification’ is not populated from the previous screen.</p> <p>The ‘Entry Date and Time to’ date must be later than the ‘Entry Date and Time from’ date.</p> <p>Reference for error message: [▶ 1321]</p> <p><input type="checkbox"/> QMPC015</p>
Entry Business Date from(*)	<p>Enter the lower bound of the search range for the business date of the message entry or use the <i>calendar</i> icon.</p> <p>Required format is: YYYY-MM-DD</p> <p>Default value is the current business date -1 if the ‘Inbound Individual Message’ or the ‘Received Communication Identification’ is not populated from the previous screen.</p> <p>The ‘Entry Date from’ date must be earlier than or equal to the current business date and earlier than the ‘Entry Date to’ date.</p> <p>Reference for error message: [▶ 1321]</p> <p><input type="checkbox"/> QMPC073</p>

Inbound Messages – Search Criteria	
Entry Business Date to(*)	<p>Enter the upper bound of the search range for the business date of the message entry or use the <i>calendar</i> icon.</p> <p>Required format is: YYYY-MM-DD</p> <p>Default value is the current business date if the 'Inbound Individual Message' or the 'Received Communication Identification' is not populated from the previous screen.</p> <p>The 'Entry Date to' date must be later than the 'Entry Date from' date.</p>
<p>Inbound Messages – List</p> <p>Repetitive block for each business object of an inbound message</p>	
Entry Date and Time	<p>Shows the calendar date and time when the inbound message entered T2S.</p> <p>Displayed format is: YYYY-MM-DD hh:mm:ss:µsµsµsµsµs</p>
Communication Mode	<p>Shows the mode of communication from the possible values:</p> <ul style="list-style-type: none"> <input type="checkbox"/> U2A <input type="checkbox"/> A2A
Inbound Individual Message	Shows the identification of the individual message.
Received Communication Identification	Shows the internal generated identification for the inbound communication.
4-Eyes Identification	Shows the identification of the 4-eyes mode which is only used in case of an approval request in 4-eyes mode.
Sender Message Reference	Shows the identification of the original message sent in the business application header.
Sender File Reference	Shows the identification of the original file containing the message.
Business Validation Status	<p>Shows the business validation status from the possible values:</p> <ul style="list-style-type: none"> <input type="checkbox"/> True (business validation successful) <input type="checkbox"/> False (business validation finished with error)
Inbound Queuing Status	<p>Shows the inbound queuing status from the possible values:</p> <ul style="list-style-type: none"> <input type="checkbox"/> True (request is currently queued)

Inbound Messages – Search Criteria	
	<input type="checkbox"/> False (request is not queued)
Message Type	Shows the message type according to the ISO 20022 standard.
Entry Business Date	Shows the business date when T2S received the message. Displayed format is: YYYY-MM-DD
User	Shows the user who initiated the communication.
Network Service	Shows the name of the network service.
Sending Party Short Name	Shows the short name of the business sending party.
Party Technical Address - Sender	Shows the technical address of the sender. Displayed format is: max. 256 characters in UTF-8 except '<'; '>'; '&'
ISO 20022 Error Code	Shows the error code for the rejection.

Buttons

Search	<p>This function enables you to start a search according to the criteria entered. The results are displayed in a list on the same screen.</p> <p>If the search retrieves a single record, the <i>details</i> screen is displayed directly.</p> <p>Next screens:</p> <ul style="list-style-type: none"> <input type="checkbox"/> <i>Inbound messages – search/list</i> screen <input type="checkbox"/> <i>Inbound message – details</i> screen [▶ 636] <p>References for error messages: [▶ 1321]</p> <ul style="list-style-type: none"> <input type="checkbox"/> QMPC015 <input type="checkbox"/> QMPC073
Reset	<p>This function enables you to set default search criteria and blanks out of all optional criteria.</p> <p>Next screen:</p> <ul style="list-style-type: none"> <input type="checkbox"/> <i>Inbound messages – search/list</i> screen
Related Outbound Messages	<p>This function enables you to display the outbound messages related to the selected inbound message.</p> <p>Next screens:</p>

	<ul style="list-style-type: none"> <input type="checkbox"/> <i>Outbound messages – search/list</i> screen [▶ 646] (if the inbound message is linked to more than 1 outbound message) <input type="checkbox"/> <i>Outbound message – details</i> screen [▶ 654] (if the inbound message is linked to 1 outbound message only)
Inbound File	<p>This function enables you to display the inbound file related to the selected inbound message.</p> <p>Next screen:</p> <ul style="list-style-type: none"> <input type="checkbox"/> <i>Inbound file – details</i> screen [▶ 626]
Details	<p>This function enables you to display the details of the selected inbound message.</p> <p>Next screen:</p> <ul style="list-style-type: none"> <input type="checkbox"/> <i>Inbound message – details</i> screen [▶ 636]

2.4.2.7 Inbound Message - Details Screen

Context of Usage

This screen displays detailed information on the selected inbound message. You can check the data and proceed further by clicking on the buttons below.

There is no usage restriction for this screen.

This function is only available in U2A mode.

Screen Access

- Services >> Communication >> Inbound Messages >> *Inbound messages – search/list* screen >> Click on the *search* and/or *details* button
- Services >> Communication >> Outbound Messages >> *Outbound messages – search/list* screen >> Click on the *search* and/or *details* button >> *Outbound message – details* screen >> Click on the *related inbound message* button
- Services >> Communication >> Outbound Messages >> *Outbound messages – search/ list* screen >> Click on the *related inbound message* button
- Cash >> Liquidity >> Immediate Liquidity Transfers >> *Immediate liquidity transfers – search/list* screen >> Click on the *related inbound message* button
- Cash >> Liquidity >> Immediate Liquidity Transfers >> *Immediate liquidity transfers – search/list* screen >> Click on the *search* and/or *details* button >> *Immediate liquidity transfer – details* screen >> Click on the *related inbound message* button

- Cash >> Settlement >> Intra-Balance Movement >> *Intra-balance movements with current and historical status – search* screen >> Click on the *search* button >> *Intra-balance movements - list* screen >> Click on the *details* button >> *Intra-balance movement – details* screen >> Click on the *related inbound message* button
- Cash >> Settlement >> Maintenance Cash Instructions >> *Maintenance cash instructions – search* screen >> Click on the *search* button >> *Maintenance cash instructions - list* screen >> Click on the *details* button >> *Amendment cash instruction - details* screen >> Click on the *related inbound message* button
- Cash >> Settlement >> Maintenance Cash Instructions >> *Maintenance cash instructions – search* screen >> Click on the *search* button >> *Maintenance cash instructions – list* screen >> Click on the *details* button >> *Cancellation cash instruction – details* screen >> Click on the *related inbound message* button
- Services >> Communication >> Inbound Files >> *Inbound files – search/list* screen >> Click on the *search* and/or *details* button >> *Inbound file – details* screen >> Click on the *related inbound message* button
- Securities >> Settlement >> Intra-Position Movements >> *Intra-position movements with current and historical status – search* screen >> Click on the *search* button >> *Intra-position movements - list* screen >> Click on the *details* button >> *Intra-position movement – details* screen >> Click on the *related inbound message* button
- Securities >> Settlement >> Maintenance Securities Instructions >> *Maintenance securities instructions – search* screen >> Click on the *search* button >> *Maintenance securities instructions - list* screen >> Click on the *details* button >> *Amendment securities instruction - details* screen >> Click on the *related inbound message* button
- Securities >> Settlement >> Maintenance Securities Instructions >> *Maintenance securities instructions – search* screen >> Click on the *search* button >> *Maintenance securities instructions – list* screen >> Click on the *details* button >> *Cancellation securities instruction - details* screen >> Click on the *related inbound message* button
- Securities >> Settlement >> Maintenance Securities Instructions >> *Maintenance securities instructions – search* screen >> Click on the *search* button >> *Maintenance securities instructions – list* screen >> Click on the *details* button >> *Hold/release instruction - details* screen >> Click on the *related inbound message* button

- Securities >> Settlement >> Settlement Instructions>> **Settlement Instructions – search** screen >> Click on the **search** button >> **Settlement instructions - list** screen >> Click on **details** button >> **Settlement instruction - details** screen >> Click on the **related inbound messages** button

Privileges

To use this screen, you need the following privilege [▶ 1214]:

- Inbound message details query

References

User Instructions Part

This screen is part of the following business scenario:

- View inbound communication [▶ 709]

Business Functionality Document

This screen corresponds to the following business function:

- Display message details (T2S.GUI.CCSE.MSG.0030)

Screenshot

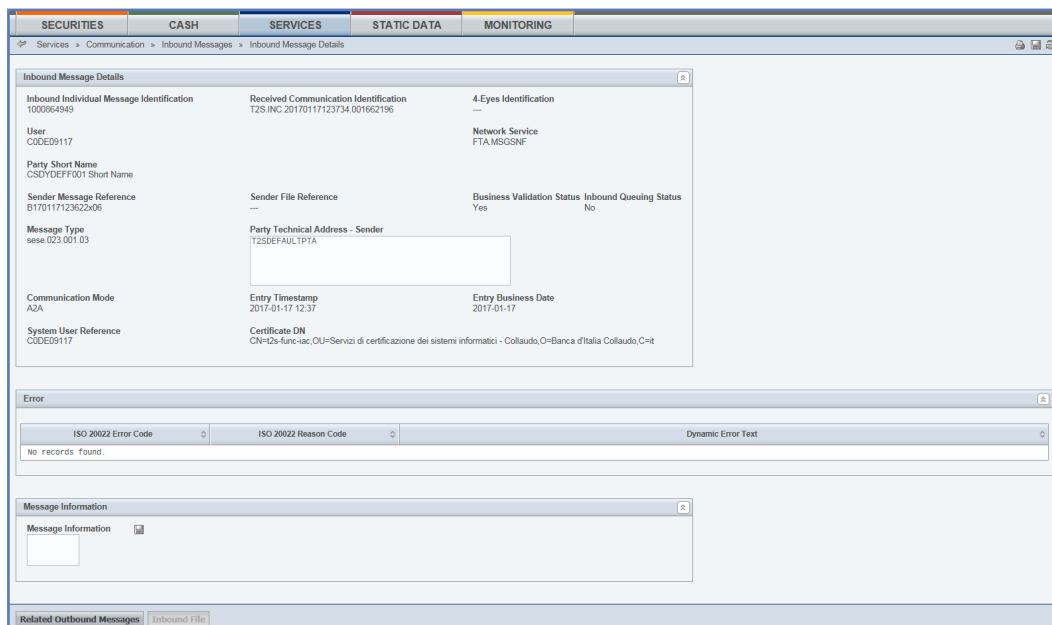

Illustration 124: Inbound message - details screen

Field Description

Inbound Message Details Information	
Entry Date and Time	Shows the calendar date and time when the inbound message entered T2S. Displayed format is: YYYY-MM-DD hh:mm:ss:µsµsµsµsµs
Communication Mode	Shows the mode of communication from the possible values: <input type="checkbox"/> U2A <input type="checkbox"/> A2A
Inbound Individual Message	Shows the identification of the individual message.

Inbound Message Details Information	
Received Communication	Shows the internal generated identification for the inbound communication.
4-Eyes Identification	Shows the identification of the 4-eyes mode which is only used in case of an approval request in 4-eyes mode.
Sender Message Reference	Shows the identification of the original message sent in the business application header.
Sender File Reference	Shows the identification of the original file containing the message.
Business Validation Status	Shows the business validation status from the possible values: <input type="checkbox"/> True (business validation successful) <input type="checkbox"/> False (business validation finished with error)
Inbound Queuing Status	Shows the inbound queuing status from the possible values: <input type="checkbox"/> True (request is currently queued) <input type="checkbox"/> False (request is not queued)
Message Type	Shows the message type according to the ISO 20022 standard.
Entry Business Date	Shows the business date when T2S received the message. Displayed format is: YYYY-MM-DD
User	Shows the user who initiated the communication.
Network Service	Shows the name of the network service.
Sending Party Short Name	Shows the short name of the business sending party.
Party Technical Address - Sender	Shows the technical address (i.e. distinguished name) of the sender. Displayed format is: max. 256 characters in UTF-8 except '<';>'; '&'
ISO 20022 Error Code	Shows the error code for the rejection.
Certificate Distinguished Name	Shows the user information which was extracted from the signature tag in the file header.
System User Reference	Shows the identification of the system user as extracted from the business application header.

Inbound Message Details Information	
Repetitive block for each error	
ISO 20022 Error Code	Shows the error code for the rejection.
ISO 20022 Reason Code	Shows the reason code for the rejection.
Dynamic Error Text	Shows a detailed error text explaining why the file was rejected.
Message Information	
Message Information	<p>Shows the detailed information of the U2A or A2A communication.</p> <p>The content of A2A message/U2A request is only displayed in case of small A2A messages/U2A requests. Bigger A2A messages/U2A requests can be displayed via the separate message <i>export</i> icon.</p> <p>Please note that for the U2A request the communication is the representation of the related http request.</p> <p>Pressing this icon exports the message based on the xml document. In addition root elements are present at the beginning and the end of the exported document. On top of the export additional information about 'Time', 'User' and 'T2S Screen of export' is available for documentation purpose.</p>

Buttons

Related Outbound Messages	<p>This function enables you to display the outbound messages related to selected inbound message.</p> <p>Next screens:</p> <ul style="list-style-type: none"> <input type="checkbox"/> <i>Outbound messages – search/list</i> screen [▶ 646] (if the inbound message is linked to more than 1 outbound message) <input type="checkbox"/> <i>Outbound message – details</i> screen [▶ 654] (if the inbound message is linked to 1 outbound message only)
Inbound File	<p>This function enables you to display the inbound file related to selected inbound message.</p> <p>Next screen:</p> <ul style="list-style-type: none"> <input type="checkbox"/> <i>Inbound file – details</i> screen [▶ 626]

2.4.2.8 Outbound Files - Search/List Screen

Context of Usage

This screen contains a number of search fields. By inputting the relevant data, you can search for outbound files. The search result will be displayed in a list, which is sorted by the values of the 'Delivery Date and Time' column descending order (default setting). After selecting an entry, you can proceed further by clicking on the buttons below. Users can see Outbound Files under their datascope.

There is no usage restriction for this screen.

This function is only available in U2A mode.

Screen Access

Services >> Communication >> Outbound Files

Privileges

To use this screen you need the following privileges [**1220**]:

- Outbound files list query
- Outbound files details query

References

User Instructions Part

This screen is part of the following business scenario:

- View outbound communication [**710**]

Business Functionality Document

This screen corresponds to the following business functions:

- Query outbound file (T2S.GUI.CCSE.OFL.0010)
- Display outbound file list (T2S.GUI.CCSE.OFL.0020)
- Display outbound file details (T2S.GUI.CCSE.OFL.0030)

Screenshot

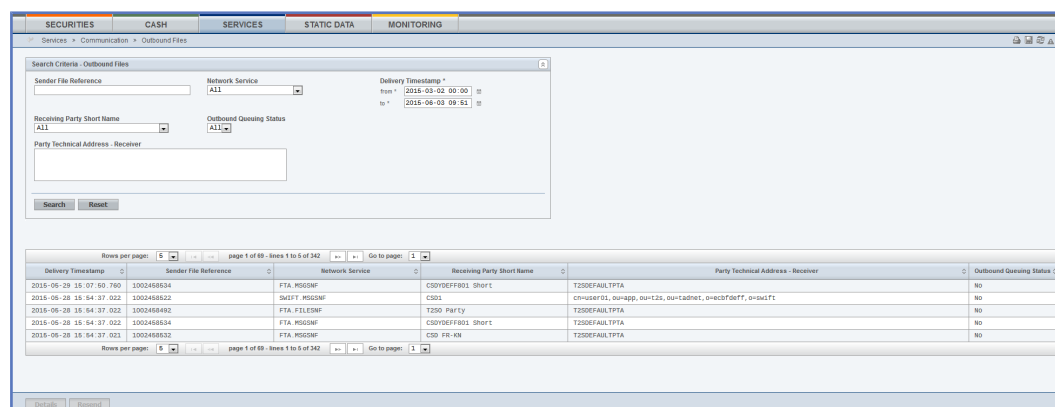

Illustration 125: Outbound files - search/list screen

Field Description

Outbound Files – Search Criteria	
Sender File Reference	Enter the sender file identification of the original file containing the message(s). Required format is: max. 16 characters (SWIFT-x)

Outbound Files – Search Criteria	
Network Service	Select the name of the network service from the drop-down menu. The default value is 'All'.
Outbound Communication ID	Enter the technical ID of the outbound communication. Required format is: Integer
Receiving Party Short Name	Select the short name of the receiving party from the drop-down menu. The default value is 'All'.
Party Technical Address	Enter the technical address (i.e. distinguished name) of the party. Required format is: max. 256 characters (UTF-8 except '<'; '>'; '&') Reference for error message [▶ 1372]: <input type="checkbox"/> IICR001
Outbound Queuing Status	Select the outbound queuing status of the file from the possible values: <input type="checkbox"/> Yes <input type="checkbox"/> No <input type="checkbox"/> All (default value)
Delivery Date and Time from*	Enter the lower bound of the search range for the date and time of the delivery or use the <i>calendar</i> icon. The default value is the current date – start of real-time settlement. Required format is: YYYY-MM-DD hh:mm:ss The 'Delivery Date and Time from' date must be earlier than or equal to the current business date and earlier than the 'Delivery Date and Time to' date. References for error messages [▶ 1372]: <input type="checkbox"/> QMPC015 <input type="checkbox"/> QMPC073
Delivery Date and Time to*	Enter the upper bound of the search range for the date and time of the delivery or use the <i>calendar</i> icon. The default value is the current date and time. Required format is: YYYY-MM-DD hh:mm:ss The 'Delivery Date and Time to' date must be later than the 'Delivery Date and Time from' date. Reference for error message [▶ 1372]: <input type="checkbox"/> QMPC015

Outbound Files – Search Criteria	
Outbound Files – List	
Repetitive block for each business object of an outbound file	
Delivery Date and Time	Shows the date and time when the outbound file was delivered. Displayed format is: YYYY-MM-DD hh:mm:ss:µsµsµsµsµs
Sender File Reference	Shows the sender file identification of the original file containing the message(s).
Outbound Communication ID	Shows the technical ID of the outbound communication.
Network Service	Shows the name of the network service.
Receiving Party Short Name	Shows the short name of the receiving party.
Party Technical Address	Shows the technical address (i.e. distinguished name) of the party. Displayed format is: max. 256 characters (UTF-8 except '<'; '>'; '&')
Outbound Queuing Status	Shows the outbound queuing status of the file from the possible values: <input type="checkbox"/> Yes <input type="checkbox"/> No

Buttons

Search	<p>This function enables you to start a search according to the criteria entered. The results are displayed in a list on the same screen.</p> <p>If the search retrieves a single record, the <i>details</i> screen is displayed directly.</p> <p>Next screens:</p> <ul style="list-style-type: none"><input type="checkbox"/> <i>Outbound files – search/list</i> screen<input type="checkbox"/> <i>Outbound file – details</i> screen [▶ 644] <p>References for error messages [▶ 1372]:</p> <ul style="list-style-type: none"><input type="checkbox"/> QMPC015<input type="checkbox"/> QMPC073

Reset	This function enables you to set default search criteria and blanks out all optional criteria. Next screen: <input type="checkbox"/> <i>Outbound files – search/list</i> screen
Details	This function enables you to display the details of the selected outbound file. Next screen: <input type="checkbox"/> <i>Outbound file – details</i> screen [▶ 644]

2.4.2.9 Outbound File - Details Screen

Context of Usage

This screen displays detailed information on the selected outbound file. You can check the data and proceed further by clicking on the buttons below.

There is no usage restriction for this screen.

This function is only available in U2A.

Screen Access

- Services >> Communication >> Outbound Files >> *Outbound files – search/list* screen >> Click on the *search* and/or *details* button
- Services >> Communication >> Outbound Messages >> *Outbound messages – search/list* screen >> Click on the *outbound file* button
- Services >> Communication >> Outbound Messages >> *Outbound messages – search/list* screen >> Click on the *search* and/or *details* button >> *Outbound message – details* screen >> Click on the *outbound file* button

Privileges

To use this screen you need the following privileges [▶ 1220]:

- Outbound files details query
- Resend Communication

References

User Instructions Part

This screen is part of the following business scenario:

- View outbound communication [▶ 710]

Business Functionality Document

This screen corresponds to the following business functions:

- Display message details (T2S.GUI.CCSE.MSG.0030)
- Display outbound file details (T2S.GUI.CCSE.OFL.0030)

Screenshot

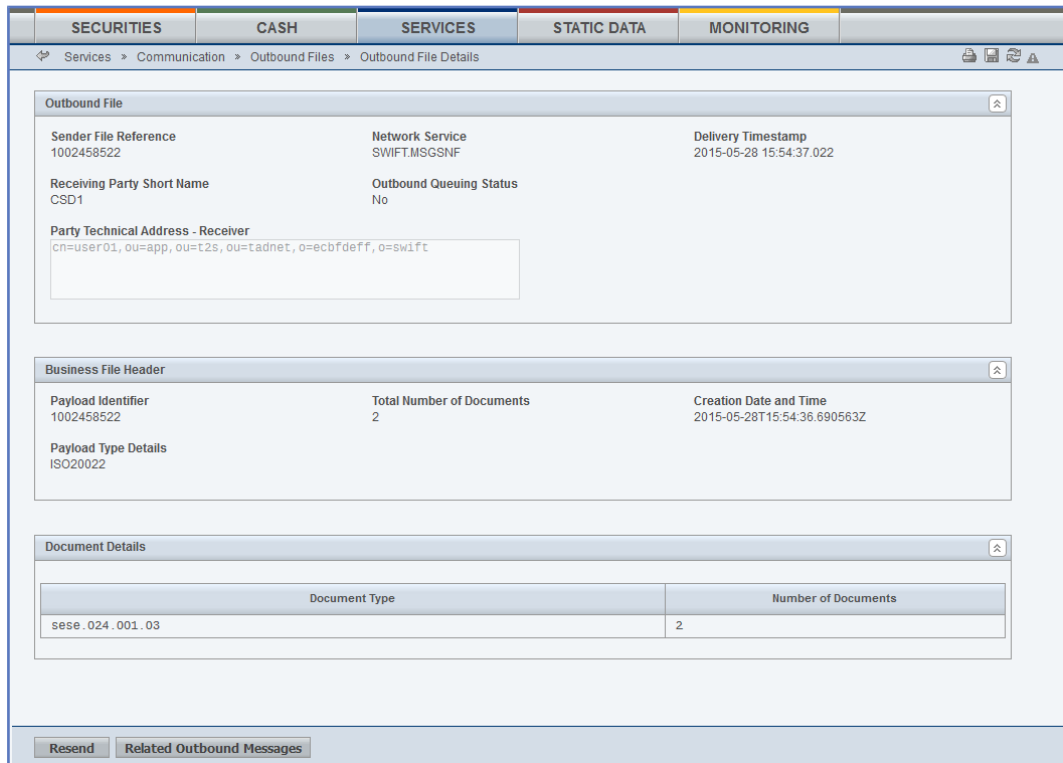

Illustration 126: Outbound file - details screen

Field Description

Outbound Files Details Information	
Delivery Date and Time	Shows date and time when the file was delivered. Displayed format is: YYYY-MM-DD hh:mm:ss:µsµsµsµsµs
Sender File Reference	Shows the sender file identification of the original file containing the message(s).
Network Service	Shows the name of the network service.
Receiving Party Short Name	Shows the short name of the receiving party.
Party Technical Address	Shows the technical address of a party. Reference for error message [▶ 1371]: <input type="checkbox"/> IICR001
Outbound Queuing Status	Shows the outbound queuing status of the outbound file from the possible values: <input type="checkbox"/> Yes <input type="checkbox"/> No
Business File Header	
Payload Details	
Payload Identifier	Shows the unique identification of the file delivered by the sender.

Outbound Files Details Information	
Creation Date and Time	Shows the date and time of the creation of the file. Displayed format is: YYYY-MM-DD hh:mm:ss:µsµsµsµsµs
Total Number of Documents	Shows the total number of documents within the file.
Payload Type Details	Shows information about the type of payload and declaration of the payload content.
Document Details	
Repetitive block for each business object of an outbound file	
Document Type	Shows the type of items contained in the document set.
Number of Documents	Shows the number of messages for each declared type.

Buttons

Related Outbound Messages	<p>This function enables you to display the outbound messages related to the selected outbound file.</p> <p>Next screens:</p> <ul style="list-style-type: none"> <input type="checkbox"/> <i>Outbound messages – search/list</i> screen [▶ 646] (if the outbound file is linked to more than one outbound message) <input type="checkbox"/> <i>Outbound message – details</i> screen [▶ 654] (if the outbound file is linked to one outbound message only)
Resend	<p>This function enables you to resend the selected outbound file.</p> <p>Next screen:</p> <ul style="list-style-type: none"> <input type="checkbox"/> <i>Outbound file – details</i> screen <p>References for error messages [▶ 1371]:</p> <ul style="list-style-type: none"> <input type="checkbox"/> IICR001 <input type="checkbox"/> IICR002

2.4.2.10 Outbound Messages - Search/List Screen

Context of Usage

This screen contains a number of search fields. By inputting the relevant data, you can search for subscribed outbound messages and those sent compulsory. The search result will be displayed in a list, which is sorted by the values of the 'Delivery Date and Time' column in descending order (default setting). Only mes-

sages subscribed via message subscription rules and those messages compulsory sent will be displayed. After selecting an entry, you can proceed further by clicking on the buttons below.

This screen shows all outbound messages irrespective of whether they were sent via file or as single message. Users can see Outbound Messages under their datascope.

There is no usage restriction for this screen.

This function is only available in U2A mode.

Screen Access

- Services >> Communication >> Outbound Messages
- Services >> Communication >> Inbound Messages >> *Inbound messages – search/list* screen >> Click on the *related outbound messages* button
- Services >> Communication >> Inbound Messages >> *Inbound messages – search/list* screen >> Click on the *search* and/or *details* button >> *Inbound message - details* screen >> Click on the *related outbound messages* button
- Services >> Communication >> Outbound Files >> *Outbound files – search/list* screen >> Click on the *search* and/or *details* button >> *Outbound file - details* screen >> Click on the *related outbound messages* button
- Cash >> Liquidity >> Immediate Liquidity Transfers >> *Immediate liquidity transfers - search/list* screen >> Click on the *related outbound messages* button
- Cash >> Liquidity >> Immediate Liquidity Transfers >> *Immediate liquidity transfers – search/list* screen >> Click on the *search* and/or *details* button >> *Immediate liquidity transfers – details* screen >> Click on the *related outbound messages* button
- Cash >> Settlement >> Intra-Balance Movements >> *Intra-balance movements – search/list* screen >> Click on the *search* button >> *Intra-balance movements – search/list* screen >> Click on the *details* button >> *Intra-balance movement - details* screen >> Click on the *related outbound messages* button
- Cash >> Settlement >> Maintenance Cash Instructions >> *Maintenance cash instructions – search/list* screen >> Click on the *search* button >> *Maintenance cash instructions – search/list* screen >> Click on the *details* button >> *Amendment cash instruction - details* screen >> Click on the *related outbound message* button

- Securities >> Settlement >> Maintenance Securities Instructions >> *Maintenance securities instructions – search/list* screen >> Click on the *search* button >> *Maintenance securities instructions – search/list* screen >> Click on the *details* button >> *Amendment securities instruction - details* screen >> Click on the *related outbound message* button
- Securities >> Settlement >> Intra-Position Movements >> *Intra-position movements – search/list* screen >> Click on the *search* button >> *Intra-position movements – search/list* screen >> Click on the *details* button >> *Intra –position movement - details* screen >> Click on the *related outbound messages* button
- Cash >> Settlement >> Maintenance Cash Instructions >> *Maintenance cash instructions – search/list* screen >> Click on the *search* button >> *Maintenance cash instructions – search/list* screen >> Click on the *details* button >> *Cancellation cash instruction – details* screen >> Click on the *related outbound message* button
- Securities >> Settlement >> Maintenance Securities Instructions >> *Maintenance securities instructions – search/list* screen >> Click on the *search* button >> *Maintenance securities instructions – search/list* screen >> Click on the *details* button >> *Cancellation securities instruction - details* screen >> Click on the *related outbound message* button
- Securities >> Settlement >> Maintenance Securities Instructions >> *Maintenance securities instructions – search/list* screen >> Click on the *search* button >> *Maintenance securities instructions – search/list* screen >> Click on the *details* button >> *Hold/release instruction - details* screen >> Click on the *related outbound message* button
- Securities >> Settlement >> Settlement Instructions >> *Settlement Instructions – search/list* screen >> Click on the *search* button >> *Settlement instructions – search/list* screen >> Click on the *details* button >> *Settlement instruction - details* screen >> Click on the *related outbound messages* button

Privileges

To use this screen, you need the following privileges [▶ 1221]:

- Outbound message list query
- Outbound message details query
- Resend Communication

References**User Instructions Part**

This screen is part of the following business scenario:

- View outbound communication [▶ 710]

Business Functionality Document

This screen corresponds to the following business functions:

- Query messages (T2S.GUI.CCSE.MSG.0010)
- Display message list (T2S.GUI.CCSE.MSG.0020)

Screenshot

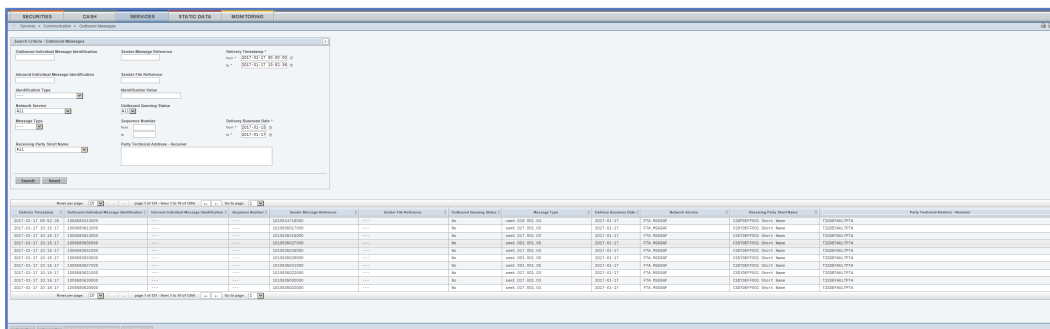

Illustration 127: Outbound messages - search/list Screen

Field Description

Outbound Messages – Search Criteria	
Outbound Individual Message Identification	Enter the technical identification of the outbound individual message. Required format is: Integer
Inbound Individual Message Identification	Enter the technical identification of the inbound individual message. Required format is: Integer
Network Service	Select the name of the network service from the drop-down menu. The default value is 'All'.
Receiving Party Short Name	Select the short name of the receiving party from the drop-down-menu. The default value is 'All'.
Party Technical Address	Enter the technical address (i.e. distinguished name) of the receiving party. Required format is: max. 256 characters (UTF-8 except '<'; '>'; '&') Reference for error message [1373]: <input type="checkbox"/> IICR001
Message Type	Select the request type (ISO 20022) for the message from the drop-down menu. The default value is 'All'.
Sender Message Reference	Enter the identification of the message as assigned by the message sender. Required format is: max. 16 characters (SWIFT-x)
Sender File Reference	Enter the sender file identification of the file containing the message(s).

Outbound Messages – Search Criteria	
	Required format is: max. 16 characters (SWIFT-x)
Identification Type	<p>Select the type of identification of the message from the possible values:</p> <ul style="list-style-type: none"> <input type="checkbox"/> T2S Instruction Reference <input type="checkbox"/> Transfer Identification (for Liquidity Transfers) <input type="checkbox"/> Blank (for non-usage of the search criterion and used as default value) <p>The Identification Type must be either 'T2S Instruction Reference' or 'Transfer Identification' if the Instruction Value is filled.</p> <p>The Identification Type must be blank if the Identification Value is blank.</p>
Identification Value	<p>Enter the unique identification of the Instruction and Liquidity Transfer if instruction type is not blank.</p> <p>The Identification Value must be filled if the Instruction Type is filled with 'T2S Instruction Reference' or 'Transfer Identification'.</p> <p>The Identification Value must not be filled if the Instruction Type is filled with 'blank'.</p>
Outbound Queuing Status*	<p>Select the outbound queuing status of the message from the possible values:</p> <ul style="list-style-type: none"> <input type="checkbox"/> Yes <input type="checkbox"/> No <input type="checkbox"/> All (default value)
Delivery Date and Time from(*)	<p>Enter the lower bound of the search range for the calendar date and time of the system entry of the outbound message or use the <i>calendar</i> icon. The default value is the current date – start of real-time settlement if the 'Inbound Individual Message Identification' / 'T2S Instruction Reference' / 'Transfer Identification' / 'Sender File Reference' is not populated from the previous screen.</p> <p>Required format is: YYYY-MM-DD hh:mm:ss</p> <p>The 'Delivery Date and Time from' date must be a valid calendar date/time and earlier than or equal to the current T2S date. The 'Delivery Date and Time from' date must be earlier than the 'Delivery Date and Time to' date.</p>

Outbound Messages – Search Criteria	
	<p>Reference for error message [▶ 1373]:</p> <p><input type="checkbox"/> QMPC015</p>
Delivery Date and Time to(*)	<p>Enter the upper bound of the search range for the calendar date and time of the system entry of the outbound message or use the <i>calendar</i> icon. The default value is the current date and time if the 'Inbound Individual Message Identification' / 'T2S Instruction Reference' / 'Transfer Identification' / 'Sender File Reference' is not populated from the previous screen.</p> <p>Required format is: YYYY-MM-DD hh:mm:ss</p> <p>The 'Delivery Date and Time to' date must be later than the 'Delivery Date and Time from' date and a valid T2S calendar date/time.</p> <p>Reference for error message [▶ 1373]:</p> <p><input type="checkbox"/> QMPC015</p>
Delivery Business Date from(*)	<p>Enter the lower bound of the search range for the business date from which the outbound message was delivered or use the <i>calendar</i> icon. The default value is the current business date if the 'Inbound Individual Message Identification' / 'T2S Instruction Reference' / 'Transfer Identification' / 'Sender File Reference' is not populated from the previous screen.</p> <p>Required format is: YYYY-MM-DD</p> <p>The 'Delivery Business Date from' date must be a valid T2S calendar date earlier than or equal to the current T2S calendar date.</p> <p>Reference for error message [▶ 1373]:</p> <p><input type="checkbox"/> QMPC015</p>
Delivery Business Date to(*)	<p>Enter the upper bound of the search range for the date until which the outbound message was delivered or use the <i>calendar</i> icon. The default value is the current business date if the 'Inbound Individual Message Identification' / 'T2S Instruction Reference' / 'Transfer Identification' / 'Sender File Reference' is not populated from the previous screen.</p> <p>Required format is: YYYY-MM-DD</p>

Outbound Messages – Search Criteria	
	<p>The 'Delivery Business Date to' date must be a valid T2S business date.</p> <p>Reference for error message [▶ 1373]:</p> <ul style="list-style-type: none"> <input type="checkbox"/> QMPC015
<p>Outbound Messages – List</p> <p>Repetitive block for each business object of an outbound message</p>	
Delivery Date and Time	<p>Shows the date and time when the message was delivered in T2S.</p> <p>Displayed format is: YYYY-MM-DD hh:mm:ss:µsµsµsµsµs</p>
Outbound Individual Message Identification	Shows the identification of the outbound individual message.
Inbound Individual Message Identification	Shows the identification of the inbound individual message.
Outbound Message Sequence Number	Shows the counter for the external message sequence which is available once per party technical address.
Sender Message Reference	Shows the identification of the outbound message as assigned by the message sender.
Sender File Reference	Shows the identification of the original file containing the message(s).
Outbound Queuing Status	<p>Shows the outbound queuing status of the message from the possible values:</p> <ul style="list-style-type: none"> <input type="checkbox"/> Yes <input type="checkbox"/> No
Message Type	Shows the ISO 20022 request type of the message.
Delivery Business Date	<p>Shows the business date when T2S started the delivery of the message.</p> <p>Displayed format is: YYYY-MM-DD</p>
Network Service	Shows the name of the network service.
Receiving Party Short Name	Shows the short name of the receiving party.
Party Technical Address	Shows the technical address (i.e. distinguished name) of the receiving party.

Outbound Messages – Search Criteria	
	<p>Displayed format: max. 256 characters (UTF-8 except '<'; '>'; '&')</p> <p>Reference for error message [▶ 1373]:</p> <ul style="list-style-type: none"> <input type="checkbox"/> IICR001

Buttons

Search	<p>This function enables you to start a search according to the criteria entered. The results are displayed in a list on the same screen.</p> <p>If the search retrieves a single record, the <i>details</i> screen is displayed directly.</p> <p>Next screens:</p> <ul style="list-style-type: none"> <input type="checkbox"/> <i>Outbound messages – search/list</i> screen <input type="checkbox"/> <i>Outbound message – details</i> screen [▶ 654] <p>Reference for error message [▶ 1373]:</p> <ul style="list-style-type: none"> <input type="checkbox"/> QMPC015
Reset	<p>This function enables you to set default search criteria and blanks out all optional criteria.</p> <p>Next screen:</p> <ul style="list-style-type: none"> <input type="checkbox"/> <i>Outbound messages – search/list</i> screen
Outbound File	<p>This function enables you to display the details of the related outbound file.</p> <p>Next screen:</p> <ul style="list-style-type: none"> <input type="checkbox"/> <i>Outbound file – details</i> screen [▶ 644]
Related Inbound Messages	<p>This function enables you to display the inbound messages related to the selected outbound message.</p> <p>Next screen:</p> <ul style="list-style-type: none"> <input type="checkbox"/> <i>Inbound message – details</i> screen [▶ 636]
Resend	<p>This function enables you to resend the selected outbound message.</p> <p>Next screen:</p> <ul style="list-style-type: none"> <input type="checkbox"/> <i>Outbound messages – search/list</i> screen <p>References for error messages [▶ 1373]:</p> <ul style="list-style-type: none"> <input type="checkbox"/> IICR001 <input type="checkbox"/> IICR002

Details	This function enables you to display the details of the selected outbound message. Next screen: <input type="checkbox"/> <i>Outbound message – details</i> screen [654]
---------	--

2.4.2.11 Outbound Message - Details Screen

Context of Usage

This screen displays detailed information on the selected outbound message. Only messages subscribed via message subscription rules and those messages compulsory sent will be displayed. You can check the data and proceed further by clicking on the buttons below.

There is no usage restriction for this screen.

This function is only available in U2A mode.

Screen Access

- Services >> Communication >> Outbound Messages >> *Outbound messages – search/list* screen >> Click on the *search* and/or *details* button
- Services >> Communication >> Inbound Messages >> *Inbound messages – search/list* screen >> Click on the *related outbound messages* button
- Services >> Communication >> Inbound Messages >> *Inbound messages – search/list* screen >> Click on the *search* and/or *details* button >> *Inbound message – details* screen >> Click on the *related outbound messages* button
- Services >> Communication >> Outbound Files >> *Outbound files – search/list* screen >> Click on the *search* and/or *details* button >> *Outbound file – details* screen >> Click on the *related outbound messages* button
- Cash >> Liquidity >> Immediate Liquidity Transfers >> *Immediate liquidity transfers - search/list* screen >> Click on the *related outbound messages* button
- Cash >> Liquidity >> Immediate Liquidity Transfers >> *Immediate liquidity transfers - search/list* screen >> Click on the *search* and/or *details* button >> *Immediate liquidity transfer – details* screen >> Click on the *related outbound messages* button
- Cash >> Settlement >> Intra-Balance Movements >> *Intra-balance movements – search/list* screen >> Click on the *search* button >> *Intra-balance movements – search/list* screen >> Click on the *details* button >> *Intra-balance movement - details* screen >> Click on the *related outbound messages* button

- Securities >> Settlement >> Intra-Position Movements >> *Intra-position movements – search/list* screen >> Click on the *search* button >> *Intra-position movements – search/list* screen >> Click on the *details* button >> *Intra-position movement - details* screen >> Click on the *related outbound messages* button
- Cash >> Settlement >> Maintenance Cash Instructions >> *Maintenance cash instructions – search/list* screen >> Click on the *search* button >> *Maintenance cash instructions – search/list* screen >> Click on the *details* button >> *Amendment cash instruction - details* screen >> Click on the *related outbound message* button
- Securities >> Settlement >> Maintenance Securities Instructions >> *Maintenance securities instructions – search/list* screen >> Click on the *search* button >> *Maintenance securities instructions – search/list* screen >> Click on the *details* button >> *Amendment securities instruction - details* screen >> Click on the *related outbound message* button
- Cash >> Settlement >> Maintenance Cash Instructions >> *Maintenance cash instructions – search/list* screen >> Click on the *search* button >> *Maintenance cash instructions – search/list* screen >> Click on the *details* button >> *Cancellation cash instruction – details* screen >> Click on the *related outbound message* button
- Securities >> Settlement >> Maintenance Securities Instructions >> *Maintenance securities instructions – search/list* screen >> Click on the *search* button >> *Maintenance securities instructions – search/list* screen >> Click on the *details* button >> *Cancellation securities instruction - details* screen >> Click on the *related outbound message* button
- Securities >> Settlement >> Maintenance Securities Instructions >> *Maintenance securities instructions – search/list* screen >> Click on the *search* button >> *Maintenance securities instructions – search/list* screen >> Click on the *details* button >> *Hold/release instruction - details* screen >> Click on the *related outbound message* button
- Securities >> Settlement >> Settlement Instructions >> *Settlement instructions – search/list* screen >> Click on the *search* button >> *Settlement instructions – search/list* screen >> Click on *details* button >> *Settlement instruction - details* screen >> Click on the *related outbound messages* button

Privileges

To use this screen, you need the following privileges [▶ 1221]:

- Outbound message details query
- Resend Communication

References

User Instructions Part

This screen is part of the following business scenario:

- View outbound communication [▶ 710]

Business Functionality Document

This screen corresponds to the following business functions:

- Display message details (T2S.GUI.CCSE.MSG.0030)

Screenshot

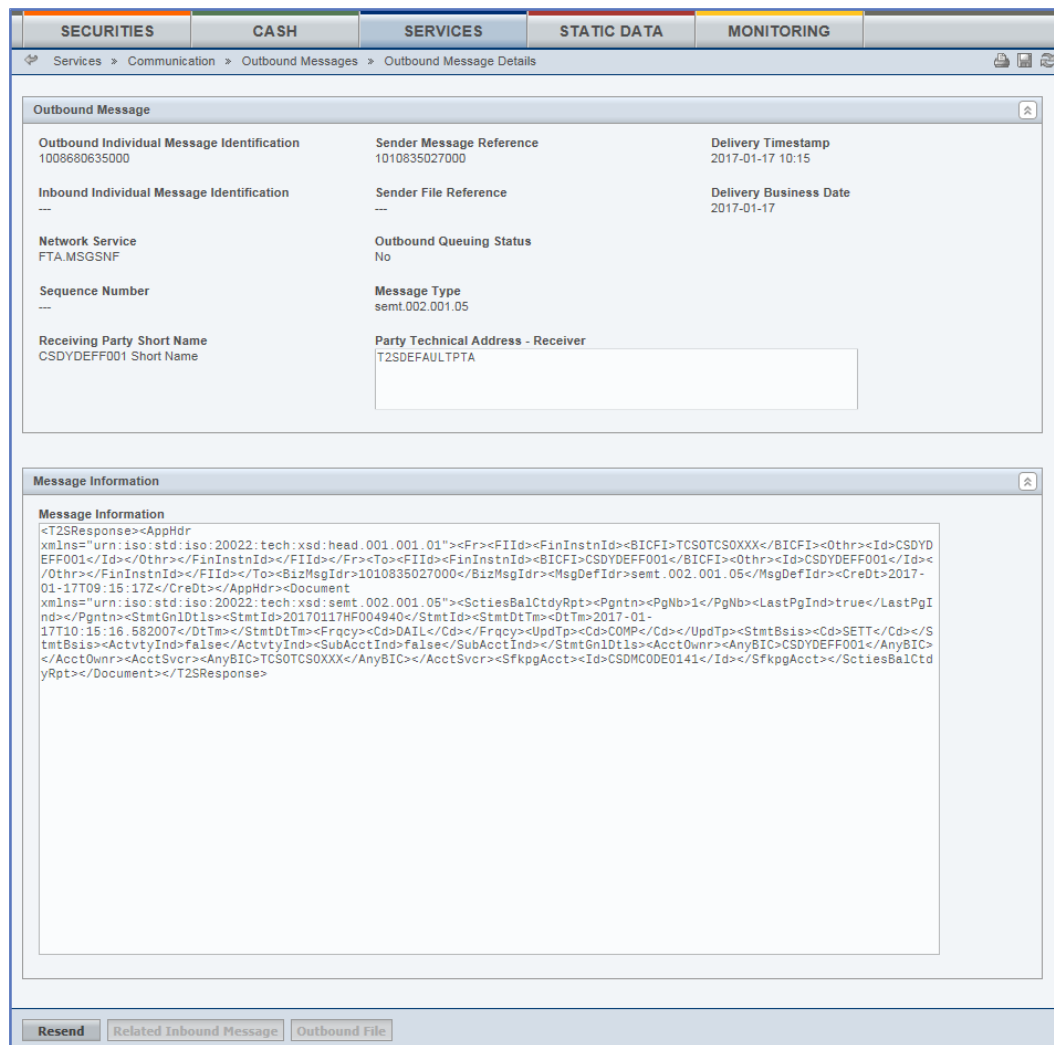

Illustration 128: Outbound message - details screen

Field Description

Outbound Message Details Information	
Delivery Date and Time	Shows the calendar date and time when the outbound message was delivered in T2S. Displayed format is: YYYY-MM-DD hh:mm:ss:µsµsµsµsµsµs
Outbound Individual Message Identification	Shows the identification of the outbound individual message.

Outbound Message Details Information	
Inbound Individual Message Identification	Shows the identification of the inbound individual message.
Outbound Message Sequence Number	Shows the counter for the external message sequence which is available once per party technical address.
Sender Message Reference	Shows the identification of the outbound message as assigned by the message sender.
Sender File Reference	Shows the identification of the original file containing the message(s).
Outbound Queuing Status	Shows the outbound queuing status of the message from the possible values: <input type="checkbox"/> Yes <input type="checkbox"/> No
Message Type	Shows the ISO 20022 request type of the message.
Delivery Business Date	Shows the business date when T2S started the delivery of the message. Displayed format is: YYYY-MM-DD
Network Service	Shows the name of the network service.
Receiving Party Short Name	Shows the short name of the receiving party.
Party Technical Address	Shows the technical address (i.e. distinguished name) of the receiving party. Reference for error message [▶ 1373]: <input type="checkbox"/> IICR001
Message Information	
Message Information	Shows detailed information of the U2A or A2A request. The content of A2A message/U2A request is only displayed in case of small A2A messages/U2A requests. Bigger A2A messages/U2A requests can be displayed via the separate message <i>export</i> icon. Pressing this icon exports the message based on the xml document. In addition root elements are present at the beginning and the end of the exported document. On top of the export additional information about 'Time', 'User' and 'T2S Screen of export' is available for documentation purpose.

Buttons

Related Inbound Messages	This function enables you to display the inbound messages related to the selected outbound message. Next screen: <input type="checkbox"/> <i>Inbound message – details</i> screen [▶ 636]
Resend	This function enables you to resend the selected outbound message. Next screen: <input type="checkbox"/> <i>Outbound message – details</i> screen References for error messages [▶ 1373]: <input type="checkbox"/> IICR001 <input type="checkbox"/> IICR002
Outbound File	This function enables you to display the outbound file related to the selected outbound message. Next screen: <input type="checkbox"/> <i>Outbound file – details</i> screen [▶ 644]

2.4.2.12 Resend Communication Screen

Context of Usage

This screen contains a number of fields regarding resend communication. You may select already sent outbound messages by entering:

- a single sequence,
- a range of sequences with explicitly mentioned values for
 - 'Sequence – from' and 'Sequence – to' or
 - 'Sequence – from' and open end or
 - 'Sequence – to' and open start
- a combination of a range of sequences and an additional single sequence
- a T2S sender message reference.

You may also resend outbound files by entering a sender file reference. Afterwards you can proceed further by clicking on the buttons below.

You can use this screen either in 2-eyes or in 4-eyes mode.

There is no usage restriction for this screen.

Screen Access

- Services >> Communication >> Resend Communication

Privileges

To use this screen, you need the following privilege [▶ 1224]:

- Resend communication

References

User Instructions Part

This screen is part of the following business scenario:

- Resend communication [[▶ 708](#)]

Business Functionality Document

This screen corresponds to the following business function:

- Request outbound message resend (T2S.GUI.CCSE.MSG.0040)

Screenshot

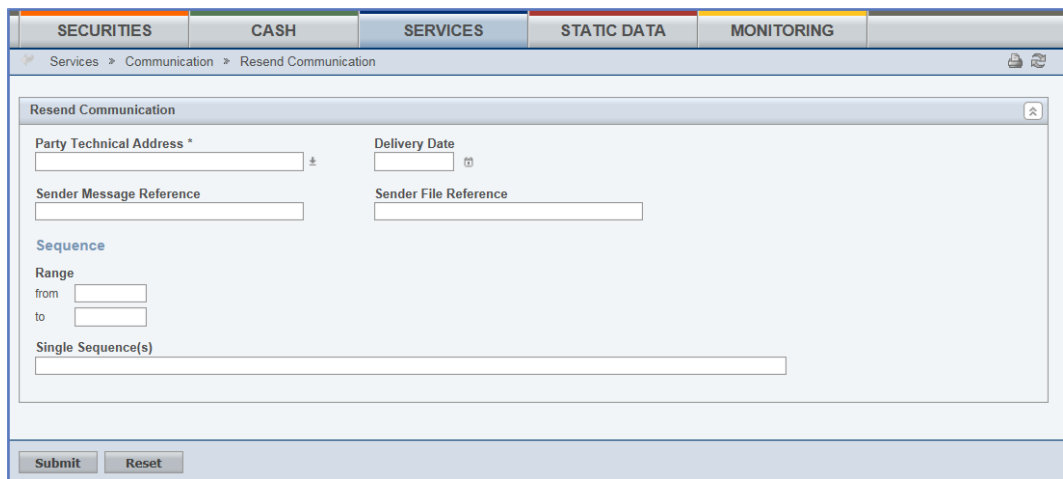

Illustration 129: Resend communication screen

Field

Description

Resend Communication	
Party Technical Address*	<p>You can choose to either enter the 'Party Technical Address' or to select it from the suggested items in the dropdown menu.</p> <p>Required format is: max. 256 characters (SWIFT-x)</p> <p>References for error messages [▶ 1379]:</p> <ul style="list-style-type: none"> <input type="checkbox"/> IICR001 <input type="checkbox"/> IICR004 <input type="checkbox"/> IICR006 <input type="checkbox"/> IICR007
Delivery Date	<p>Enter the date of the business day on which the outbound message was sent or use the <i>calendar</i> icon.</p> <p>Required format is: YYYY-MM-DD</p> <p>References for error messages [▶ 1379]:</p> <ul style="list-style-type: none"> <input type="checkbox"/> IICR003 <input type="checkbox"/> IICR004 <input type="checkbox"/> IICR006

Resend Communication	
	<input type="checkbox"/> IICR007 If you do not select a date, this field is filled in with the current business date.
Sender Message Reference	Enter the identification of the original message as sent in the business application header. Required format is: max. 16 characters (SWIFT-x) Reference for error message [▶ 1379]: <input type="checkbox"/> IICR007 You have to enter at least one field among 'Sender Message Reference', 'Sender File Reference', 'Sequence – from', 'Sequence – to' and 'Single Sequence(s)'.
Sender File Reference	Enter the identification of the original file as sent in the business application header. Required format is: max. 16 characters (SWIFT-x) Reference for error message [▶ 1379]: <input type="checkbox"/> IICR006 You have to enter at least one field among 'Sender Message Reference', 'Sender File Reference', 'Sequence – from', 'Sequence – to' and 'Single Sequence(s)'.
Sequence	
Sequence - from	Enter the lower bound of the specific outbound sequence reference. Required format is: max. 8 digits The 'Sequence – from' range must be lower than or equal to the 'Sequence – to' range. You have to enter at least one field among 'Sender Message Reference', 'Sender File Reference', 'Sequence – from', 'Sequence – to' and 'Single Sequence(s)'. Remark: To submit a resend of messages the sequence number has to be filled with up to 8 digits, without business date prefix. Leading zeros can be omitted. Business date is taken from the separate field. In case the business date field is not filled the current business date is used.
Sequence - to	Enter the upper bound of the specific outbound sequence reference.

Resend Communication	
	<p>Required format is: max. 8 digits</p> <p>The 'Sequence – to' range must be higher than or equal to the 'Sequence – from' range.</p> <p>You have to enter at least one field among 'Sender Message Reference', 'Sender File Reference', 'Sequence – from', 'Sequence – to' and 'Single Sequence(s)'.</p> <p>Remark: To submit a resend of messages the sequence number has to be filled with up to 8 digits, without business date prefix. Leading zeros can be omitted. Business date is taken from the separate field. In case the business date field is not filled the current business date is used.</p>
Single Sequence(s)	<p>Enter the outbound sequence identification you want to resend.</p> <p>Required format is: max. 169 characters (SWIFT-x)</p> <p>Reference for error message [▶ 1379]:</p> <ul style="list-style-type: none"> <input type="checkbox"/> IICR004 <p>You have to enter at least one field among 'Sender Message Reference', 'Sender File Reference', 'Sequence – from', 'Sequence – to' and 'Single Sequence(s)'.</p>

Buttons

Submit	<p>This function enables you to create a resend message request based on the selection you made, after confirmation.</p> <p>Next screen:</p> <ul style="list-style-type: none"> <input type="checkbox"/> <i>Resend communication</i> screen <p>References for error messages [▶ 1379]:</p> <ul style="list-style-type: none"> <input type="checkbox"/> IICR001 <input type="checkbox"/> IICR002 <input type="checkbox"/> IICR003 <input type="checkbox"/> IICR004 <input type="checkbox"/> IICR006 <input type="checkbox"/> IICR007
Reset	<p>This function enables you to set all fields to default value and blanks out all optional fields.</p> <p>Next screen:</p>

- Resend communication screen

2.4.3 Revisions

2.4.3.1 Revisions/Audit Trail - List Screen

Context of Usage

This screen shows search results for revisions for the selected transactional objects in a list and is not present in T2S menu. After selecting an entry, you can proceed further by clicking on the button below.

When exporting the content of this screen, you receive the list and the corresponding details for each data record.

The screen can be reached via any other *list* or *details* screen by clicking on the *revisions* button.

Screen Access

- Screen name >> Click on the *revisions* button

Privileges

To use this screen, you need (depending on the underlying object) the following privileges [[▶ 1225](#)]:

- Amendment instruction for intra-position movement or settlement instruction audit trail list query
- Amendment instruction for intra-balance movement audit trail list query
- Cancellation instruction for intra-balance movement audit trail list query
- Cancellation instruction for intra-position movement or settlement instruction audit trail list query
- Intra-balance movement audit trail list query
- Intra-position movement audit trail list query
- Immediate liquidity transfer order audit trail list query
- Penalty audit trail query
- Settlement instruction audit trail query

References

User Instructions Part

This screen is part of the following business scenario:

- View revisions [[▶ 1381](#)]

Business Functionality Document

This screen corresponds to the following business function:

- Display revision list (T2S.GUI.OSSE.REV.0010)

Screenshot

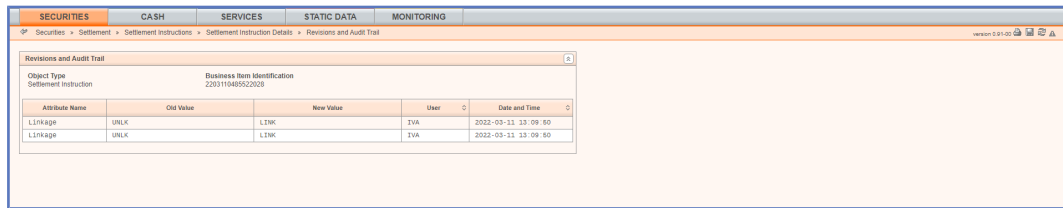

Illustration 130: Revisions/audit trail – list screen

Field

Description

Revisions – List	
Object Type	Shows the type of the selected object.
Business Item Identification 1	Shows the identification of the respective business object.
Revision/Audit Trail Entry	
Attribute Name	Shows the name of the field which changed.
Old Value	Shows the old value of an attribute which was subject to a change.
New Value	Shows the new value of an attribute after the change.
User	Shows the identification of the user who changed the data.
Date and Time	Shows the date and time at which the user changed the data. Displayed format is: YYYY-MM-DD hh:mm:ss:µsµsµsµsµsµs

Buttons

Details	This function enables you to display the details only for: Unlinking/Linking for SI, IPM, IBM. The additional detailed information will be present in a pop-up window.
---------	--

2.5 Monitoring

2.5.1 Monitoring

2.5.1.1 Securities Positions - Search/List Screen

See *Securities Positions – Search/List Screen* [▶ 169].

2.5.1.2 Securities Position - Details Screen

See *Securities Positions – Details Screen* [▶ 174].

2.5.1.3 T2S DCA Balances - Search/List Screen

See *T2S DCA Balances – Search/List Screen* [▶ 358].

2.5.1.4 T2S DCA Balance - Details Screen

See *T2S DCA Balance – Details Screen* [▶ 362].

2.6 Billing

2.6.1 Invoice Data

2.6.1.1 Invoice Data – Search/List screen

Context of Usage

~~The result is returned on the basis of the entered criteria in a list and it is sorted by the values of the Service, Parent BIC, Party BIC, Period Start date, Period End date columns in ascending order (default setting).~~

~~This screen gives also the possibility to access the details of the Invoice Data, i.e. how the total amount is divided by Service category and Service Items, and to manage the Template Corrections and Manual Corrections related to the Invoice Data.~~

~~This screen is not relevant for payment banks and ancillary systems.~~

~~The content of the list depends on the authorised user that is performing the query: ECB users can see all Invoice Data related to a System Entity; Central Bank users can see the Invoice Data for their System Entity and the ones related to their community; CSD users can see the Invoice Data for their System Entity.~~

Screen Access

- Billing >> Invoice Data >> Search
- Billing >> Manual Correction >> Search >> Click on Invoice Data button

Privileges

~~To use this screen, the following Privileges are needed:~~

- Invoice Data List Query

Screenshot

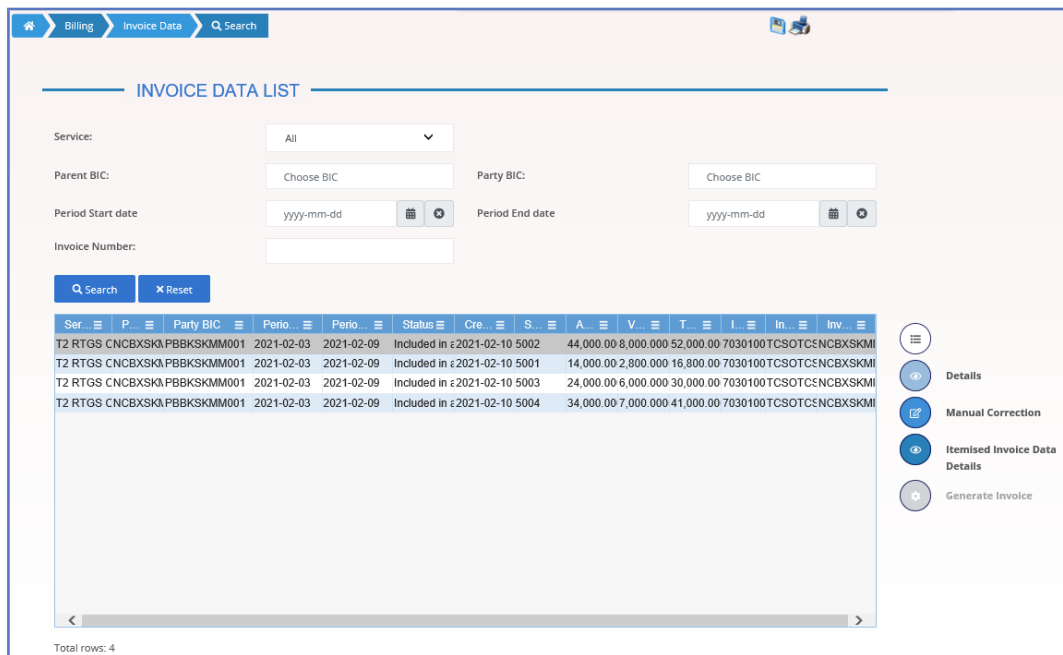

Illustration 131: Invoice Data – search/list screen {Split book approach}

Fields

Description

Invoice data – Search Criteria	
Service	<p>Select the Service from the possible values:</p> <ul style="list-style-type: none"> <input type="checkbox"/> All (default value) <input type="checkbox"/> TIPS <input type="checkbox"/> T2 RTGS COMPONENT <input type="checkbox"/> ECMS <input type="checkbox"/> T2S <p>The Service “T2 RTGS COMPONENT” is meant as T2 Service.</p>
Parent BIC	<p>Enter or select the Parent BIC of the Party to be charged.</p> <p>If the user is an ECB or CSD user, the field contains the BIC of the Operator and is read-only.</p> <p>Required format is: max. 11x characters.</p>
Party BIC	<p>Enter or select the Party BIC of the Party to be charged.</p> <p>If the user is a CSD user, this field contains the Party BIC of the CSD the user belongs to and it is read-only.</p> <p>Required format is: max. 11x characters.</p>

Invoice data – Search Criteria	
Period Start date	Enter the date that defined the Start date of the relevant Billing Period for which the Invoice Data is searched. Required format is: Date.
Period End date	Enter the date that defined the End date of the relevant Billing Period for which the Invoice Data is searched. This field must be greater than the Period Start date but within the same month. Required format is: Date.
Invoice Number	Enter the invoice number to be searched. This field is meaningful only for Invoice Data already used for the creation of an Invoice and if the latter is not cancelled. Required format is: max. 35x characters.

Invoice Data – List	
Service	Shows the Service of the returned Invoice Data.
Parent BIC	Shows the Parent BIC of the Party to be charged.
Party BIC	Shows the Party BIC of the Party to be charged.
Period Start Date	Shows the start date of the Billing Period the Invoice Data refers to.
Period End Date	Shows the end date of the Billing Period the Invoice Data refers to.
Status	Shows the status of the Invoice Data (generated, corrected, cancelled, included in an invoice).
Creation date	Shows the date in which the Invoice Data has been generated.
Service Item	Shows the Service Item of the Invoice data.
Amount without VAT	Shows the amount in EURO of the Invoice Data without VAT. The amount format foresees four decimals.
VAT amount	Shows the VAT amount in EURO of the Invoice Data. The amount format foresees four decimals. This field is shown only for Invoice Data related to Participants.

Invoice Data – List	
Total amount	Shows the total amount in EURO of the Invoice Data (VAT included). The amount format foresees four decimals.
Invoice Number	Shows the Invoice Number, when the invoice exists and its status is different from 'Cancelled'.
Invoicee Parent BIC	Shows the Parent BIC of the party receiving the invoice.
Invoicee Party BIC	Shows the Party BIC of the party receiving the invoice.

Buttons

Search	This function enables the user to start a search according to the entered criteria.
Reset	This function enables the user to set default search criteria and blanks out all optional criteria.
Details	This function enables the user to display the details of the selected Invoice Data.
Manual Correction	This function enables the user to enter the Manual Correction list screen of the selected Invoice Data.
Itemised Invoice Data Details	This function enables the user to display the Itemised Invoice Data of the selected Invoice Data.

{Split book approach}

2.6.1.2 Invoice Data – Details screen

Context of Usage	This screen enables the authorised user to see a breakdown of the Total Amount and Amount without VAT into the specific Service Categories and Service Items. An aggregation for Service Items and applied price is shown under each service category.
Screen Access	<input type="checkbox"/> Billing >> Invoice Data >> Invoice Data – Search/List screen >> Click on the Details button
Privileges	To use this screen, the following Privileges are needed: <input type="checkbox"/> Invoice Data Details Query

Screenshot

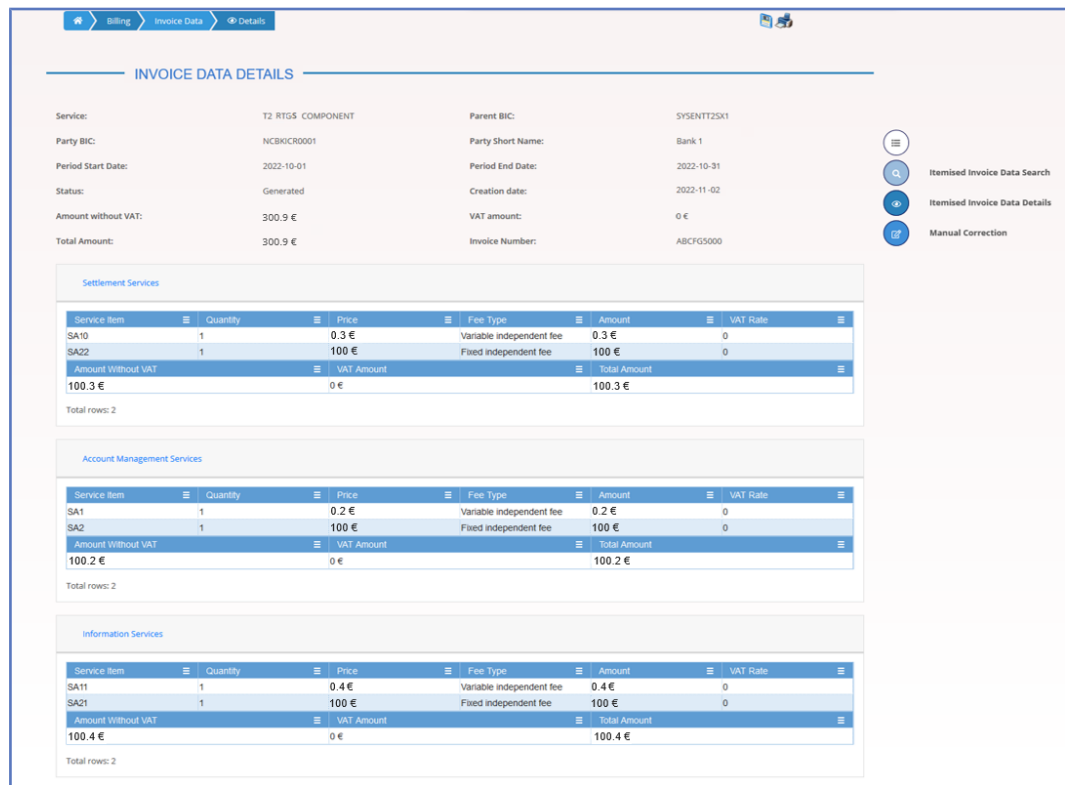

Illustration 132: Invoice Data – details screen {Split book approach}

Fields

Description

Invoice Data	
Service	Shows the Service of the returned Invoice Data.
Parent BIC	Shows the Parent BIC of the Party to be charged.
Party BIC	Shows the Party BIC of the Party to be charged.
Party Short Name	Shows the Party Short Name of the Party to be charged.
Period Start Date	Shows the start date of the Billing Period the Invoice Data refers to.
Period End Date	Shows the end date of the Billing Period the Invoice Data refers to.
Status	Shows the status of the Invoice Data (generated, corrected, cancelled, included in an invoice).
Creation date	Shows the date in which the Invoice Data has been generated.
Amount without VAT	Shows the amount in EURO of the Invoice Data without VAT. The amount format foresees four decimals.
VAT amount	Shows the VAT amount in EURO of the Invoice Data. The amount format foresees four decimals.

Invoice Data	
	This field is shown only for Invoice data related to Participants.
Total amount	Shows the total amount in EURO of the Invoice Data (VAT included). The amount format foresees four decimals.
Invoice Number	Shows the Invoice Number, when the invoice exists and its status is different from 'Cancelled'.

Total number of Units and Total Amount per Service Item and unit price	
Settlement Services	
Service Item	Shows the code and the Service Item name.
Quantity	Shows the sum of the quantities of all the Invoice Data for the same Service Item.
Price	Shows the price applied. In case of bands or tariff, each band and tariff of the Service Items is reported in one row.
Fee Type	Shows the type of the fee applied.
Amount	Shows the sum of the Amount in EURO calculated for all the Invoice Data in the set for the same Service Item. The amount format foresees four decimals.
VAT Rate	Shows the VAT rate considered in the computation, based on VAT defined by the System Entity for the applied Service Item. This field is shown only for Invoice Data related to Participants.
Settlement Services sub-total	
Amount without VAT	Shows the sum of all the Amounts in the category. The amount format, in EURO, foresees four decimals.
VAT amount	Shows the sum of the VAT amount in EURO of the Invoice Data. The amount format foresees four decimals. This field is shown only for Invoice data related to Participants.
Total amount	Shows the sum of all the Amounts and VAT Amounts in the category. The amount format, in EURO, foresees four decimals.
Account Management Services	
Service Item	Shows the code and the Service Item name.

Total number of Units and Total Amount per Service Item and unit price	
Quantity	Shows the sum of the quantities of all the Invoice Data for the same Service Item.
Price	Shows the price applied. In case of bands or tariff, each band and tariff of the Service Items is reported in one row.
Fee Type	Shows the type of the fee applied.
Amount	Shows the sum of the Amount in EURO calculated for all the Invoice Data in the set for the same Service Item. The amount format foresees four decimals.
VAT Rate	Shows the VAT rate applied, basing on VAT defined by the System Entity for the applied Service Item. The amount format foresees four decimals. This field is shown only for Invoice data related to Participants.
Account Management Services sub-totals	
Amount without VAT	Shows the sum of all the Amounts in the category. The amount format, in EURO, foresees four decimals.
VAT amount	Shows the sum of the VAT amount in EURO of the Invoice Data. The amount format foresees four decimals. This field is shown only for Invoice data related to Participants.
Total amount	Shows the sum of all the Amounts and VAT Amounts in the category. The amount format, in EURO, foresees four decimals
Information Services	
Service Item	Shows the code and the Service Item name.
Quantity	Shows the sum of the quantities of all the Invoice Data for the same Service Item.
Price	Shows the price applied. In case of bands or tariff, each band and tariff of the Service Items is reported in one row.
Fee Type	Shows the type of the fee applied.
Amount	Shows the sum of the Amount in EURO calculated for all the Invoice Data in the set for the same Service Item. The amount format foresees four decimals.

Total number of Units and Total Amount per Service Item and unit price	
VAT Rate	Shows the VAT rate applied, basing on VAT defined by the System Entity for the applied Service Item. The amount format foresees four decimals. This field is shown only for Invoice data related to Participants.
Information Services sub-totals	
Amount without VAT	Shows the sum of all the Amounts in the category. The amount format, in EURO, foresees four decimals.
VAT amount	Shows the sum of the VAT amount in EURO of the Invoice Data. The amount format foresees four decimals. This field is shown only for Invoice Data related to Participants.
Total amount	Shows the sum of all the Amounts and VAT Amounts in the category. The amount format, in EURO, foresees four decimals.

Buttons

Itemised Invoice Data Search	This function enables the user to search for itemised Invoice Data.
Itemised Invoice Data Details	This function enables the user to display the itemised Invoice Data of the selected Invoice Data.
Manual Correction	This function enables the user to enter the Manual Correction list screen of the selected Invoice Data.

{Split book approach}

2.6.1.3 Itemised Invoice Data – Search/List screen

Context of Usage

This screen enables the authorised user to display the list of Itemised Invoice Data that compose the Invoice Data selected in the previous screen. The information of the selected Invoice Data is shown in the header of the screen. Data shown in the screen are aggregated by the object the fee is charged to – a party or an account.

As default, when executing the search, this screen shows the list of all the objects involved in the Invoice Data, i.e. the Accounts and Parties. This screen gives the additional possibility to filter by a specific object in order to obtain the subset of invoice data referred to the searched element.

The search fields are shown depending on the type of search the user wants to perform. Moreover, some search fields are visible only for the Invoice Data related to a System Entity invoice.

- Screen Access**
- ~~Billing >> Invoice Data – search/list screen >> Click on the Details button >> click on the Itemised Invoice Data Search button~~
 - ~~Billing >> Invoice Data – search/list screen >> Click on the Details button >> click on the Itemised Invoice Data Details button >> click on the Itemised Invoice Data Search button~~

Privileges To use this screen, the following Privileges are needed:

- ~~Itemised Invoice Data List Query~~
- ~~Itemised Invoice Data Details Query~~

Screenshot

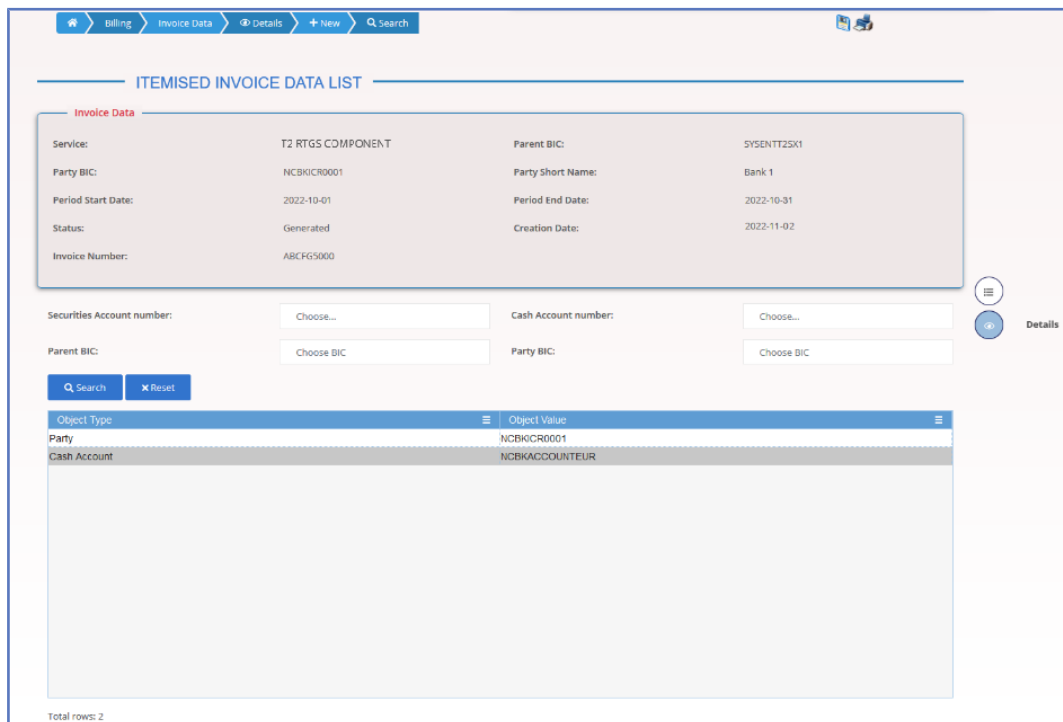

Illustration 133: ~~Itemised Invoice Data – search/list screen~~ {Split book approach}

Fields Description

Invoice Data	
Service	Shows the Service of the returned Invoice Data.
Parent BIC	Shows the Parent BIC of the Party to be charged.
Party BIC	Shows the Party BIC of the Party to be charged.
Party Short Name	Shows the Party Short Name of the Party to be charged.
Period Start Date	Shows the start date of the Billing Period the Invoice Data refers to.
Period End Date	Shows the end date of the Billing Period the Invoice Data refers to.
Status	Shows the status of the Invoice Data (generated, corrected, cancelled, included in an invoice).

Invoice Data	
Creation date	Shows the date in which the Invoice Data has been generated.
Invoice Number	Shows the Invoice Number, when the invoice exists and its status is different from 'Cancelled'.

Itemised Invoice data – Search Criteria	
Securities Account number	Enter or select a Securities Account which is relevant for the Party to be charged reported in the header. This field is visible only when the Party to be charged is a CSD. Required format is: max. 35 characters.
Cash Account number	Enter or select a Cash Account which is relevant for the Party to be charged reported in the header. This field is visible only when the Party to be charged is a CB, Payment Bank or Ancillary System. Required format is: max. 34x characters.
Parent BIC	Enter or select a Parent BIC which is relevant for the Party to be charged reported in the header. This field is visible only when the Party to be charged is a CSD or CB. Required format is: max. 11x characters.
Party BIC	Enter or select a Party BIC which is relevant for the Party to be charged reported in the header. This field is visible only when the Party to be charged is a CSD or CB. Required format is: max. 11x characters.

Itemised Invoice Data – List	
Object Type	Shows the object type the Itemised Invoice Data refers to.
Object Value	Shows the account number or party BIC according to the object value.

Buttons

Search	This function enables the user to start a search according to the entered criteria.
Reset	This function enables the user to set default search criteria and blanks out all optional criteria.
Details	This function enables the user to display the details of the selected itemised Invoice Data object.

{Split book approach}

2.6.1.4 Itemised Invoice Data – Details screen

Context of Usage

This screen shows in details the data calculated for an Invoice in a specific billing period. The content depends on the access point and the type of search: if it is accessed from the Invoice Data screens, it contains all the possible details; if it is accessed from the Itemised Invoice Data search screens, it contains the details depending on the type of item selected in the list.

Screen Access

- Billing >> Invoice Data – search/list screen >> Click on the Details button >> click on the Itemised Invoice Data Search button >> Select an item and click on the Details button
- Billing >> Invoice Data – search/list screen >> Select an item and click on the Itemised Invoice Data Details button

Privileges

To use this screen, the following Privileges are needed:

- Itemised Invoice Data Details Query

Screenshot

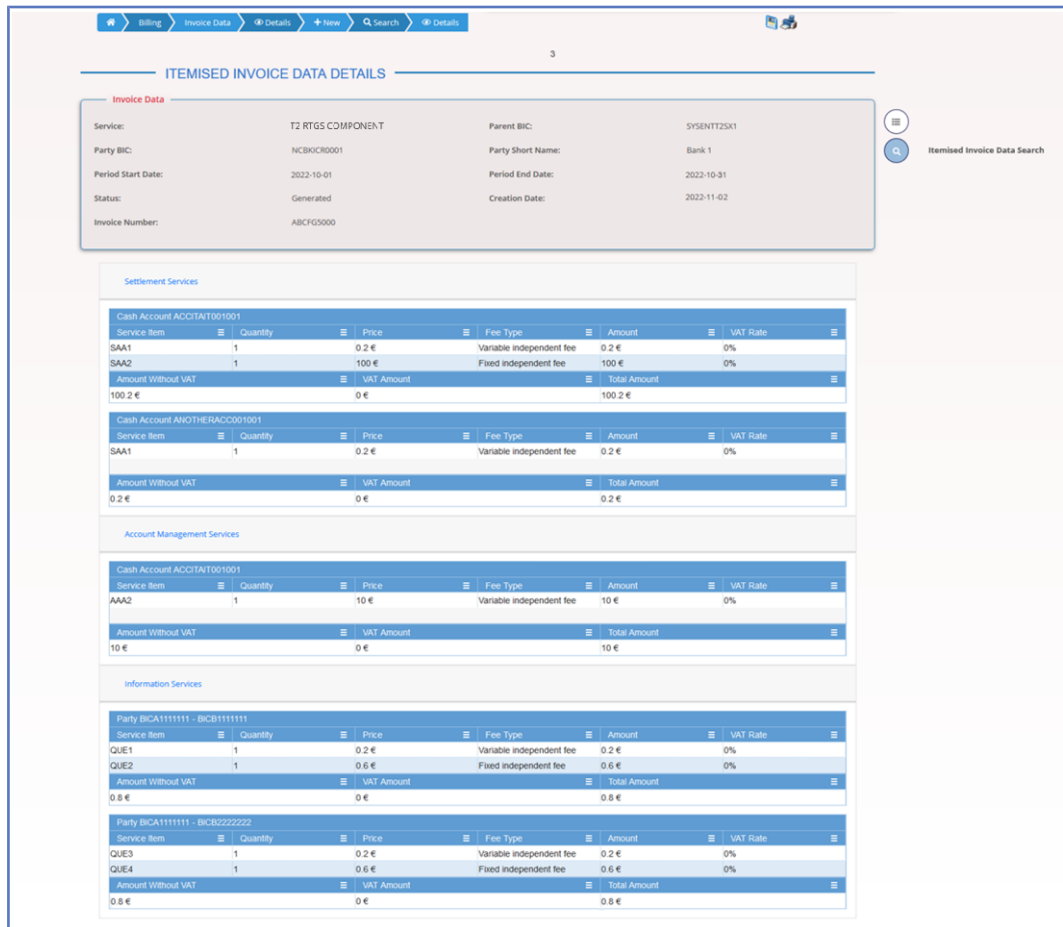

Illustration 134: **Itemised Invoice Data – details screen** (Split book approach)

Fields

Description

Invoice Data	
Service	Shows the Service of the returned Invoice Data.
Parent BIC	Shows the Parent BIC of the Party to be charged.
Party BIC	Shows the Party BIC of the Party to be charged.
Party Short Name	Shows the Party Short Name of the Party to be charged.
Period Start Date	Shows the start date of the Billing Period the Invoice Data refers to.
Period End Date	Shows the end date of the Billing Period the Invoice Data refers to.
Status	Shows the status of the Invoice Data (generated, corrected, cancelled, included in an invoice).
Creation date	Shows the date in which the Invoice Data has been generated.
Invoice Number	Shows the Invoice Number, when the invoice exists and its status is different from 'Cancelled'.

Itemised Invoice Data	
Settlement Services	
Repetitive block for each Securities Account or Cash Account	
Service Item	Shows the code and the Service Item name.
Quantity	Shows the number of billable events to be billed on the account for the specific Service Items.
Price	Shows the price applied.
Fee Type	Shows the type of the fee applied.
Amount	Shows the sum of the Amount in EURO calculated for the same Service Item and account. The amount format foresees four decimals.
VAT Rate	Shows the VAT rate considered in the computation, based on VAT defined by the System Entity for the applied Service Item. This field is shown only for Invoice data related to Participants.
Settlement Services sub-total	
Amount without VAT	Shows the sum of all the Amounts in the category. The amount format, in EURO, foresees four decimals.
VAT amount	Shows the sum of the VAT amount in EURO in the category. The amount format foresees four decimals. This field is shown only for Invoice data related to Participants.
Total amount	Shows the sum of all the Amounts and VAT Amounts in the category. The amount format, in EURO, foresees four decimals.
Account Management Services	
Repetitive block for each Securities Account or Cash Account	
Service Item	Shows the code and the Service Item name.
Quantity	Shows the number of billable events to be billed on the account for the specific Service Items.
Price	Shows the price applied. In case of bands or tariff, each band and tariff of the Service Items is reported in one row.
Fee Type	Shows the type of the fee applied.

Itemised Invoice Data	
Amount	Shows the sum of the Amount in EURO calculated for the same Service Item and account. The amount format foresees four decimals.
VAT Rate	Shows the VAT rate considered in the computation, based on VAT defined by the System Entity for the applied Service Item. This field is shown only for Invoice data related to Participants.
Account Management Services sub-totals	
Amount without VAT	Shows the sum of all the Amounts in the category. The amount format, in EURO, foresees four decimals.
VAT amount	Shows the sum of the VAT Amount in EURO in the category. The amount format foresees four decimals. This field is shown only for Invoice Data related to Participants.
Total amount	Shows the sum of all the Amounts and VAT Amounts in the category. The amount format, in EURO, foresees four decimals.
Information Services	
Repetitive block for each party	
Service Item	Shows the code and the Service Item name.
Quantity	Shows the number of billable events to be billed to the Party for the specific Service Items.
Price	Shows the price applied. In case of bands or tariff, each band and tariff of the Service Items is reported in one row.
Fee Type	Shows the type of the fee applied.
Amount	Shows the sum of the Amount in EURO calculated for the same Service Item and Party. The amount format foresees four decimals.
VAT Rate	Shows the VAT rate applied, basing on VAT defined by the System Entity for the applied Service Item. The amount format foresees four decimals. This field is shown only for Invoice data related to Participants.
Information Services sub-totals	
Amount without VAT	Shows the sum of all the Amounts in the category. The amount format, in EURO, foresees four decimals.

Itemised Invoice Data	
VAT amount	Shows the sum of the VAT amount in EURO of the Invoice Data. The amount format foresees four decimals. This field is shown only for Invoice data related to Participants.
Total amount	Shows the sum of all the Amounts and VAT Amounts in the category. The amount format, in EURO, foresees four decimals.

Buttons

Buttons	
Itemised Invoice Data Search	This function enables the user to search for Itemised Invoice Data.

{Split book approach}

2.6.2 Manual Corrections

2.6.2.1 Manual Corrections – Search/List screen

Context of Usage

This screen enables the authorised user to display the list of Manual Corrections or Template Corrections. The result is returned on the basis of the entered criteria in a list and it is sorted by the values of the Service, Status, Parent BIC, Party BIC, Period Start date, Period End, Correction Type date columns in ascending order (default setting).

This screen gives also the possibility to access the Invoice Data Search/List Screen.

The content of the list depends on the authorised user that is performing the query:

- Operators can see all Manual Corrections and Template Corrections performed in the selected period;
- ECB users can see all Manual Corrections and Template Corrections performed to a System Entity Invoice Data;
- CB users can see the Manual Corrections and Template Corrections for their System Entity and the ones related to their community.
- Billing >> Manual Correction >> Search

Screen Access

Privileges

To use this screen, the following Privileges are needed:

- Manual Correction List Query
- Invoice Data List Query

Screenshot

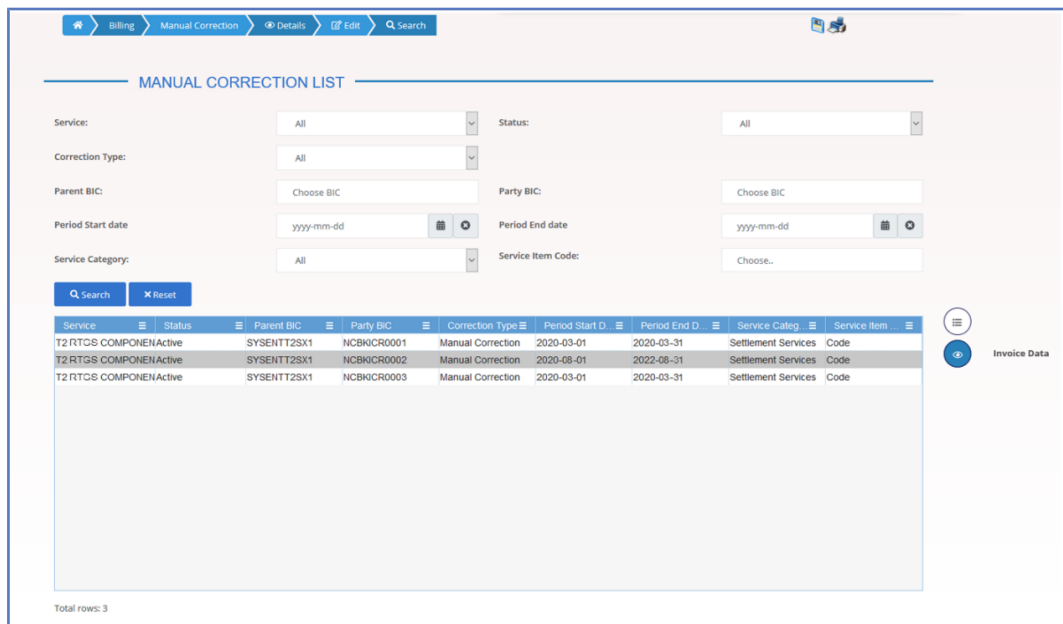

Illustration 135: **Manual Correction – search/list screen** {Split book approach}

Fields

Description

Manual Correction – Search Criteria	
Service	<p>Select the Service from the possible values:</p> <ul style="list-style-type: none"> <input type="checkbox"/> All (default value) <input type="checkbox"/> TIPS <input type="checkbox"/> T2 RTGS COMPONENT <input type="checkbox"/> ECMS <input type="checkbox"/> T2S <p>The Service “T2 RTGS COMPONENT” is meant as T2 Service.</p>
Status	<p>Select the status of the Correction from the possible values:</p> <ul style="list-style-type: none"> <input type="checkbox"/> All <input type="checkbox"/> Active (default value) <input type="checkbox"/> Deleted
Correction Type	<p>Select the Correction Type from the possible values:</p> <ul style="list-style-type: none"> <input type="checkbox"/> All (default value) <input type="checkbox"/> Template Correction <input type="checkbox"/> Manual Correction
Parent BIC	<p>Enter or select the Parent BIC of the Party the Correction refers to.</p> <p>Required format is: max. 11 characters.</p>

Manual Correction – Search Criteria	
Party BIC	Enter or select the Party BIC the Correction is applied to. Required format is: max. 11 characters.
Period Start date	Enter or pick the date that defined the Start date of the relevant Billing Period for which the Correction must be searched. Required format is: Date.
Period End date	Enter or pick the date that defined the End date of the relevant Billing Period for which the Correction must be searched. It must be greater than the Period Start date but within the same month. Required format is: Date.
Service Category	Select the Service Category from the possible values: <ul style="list-style-type: none"> <input type="checkbox"/> All (default value) <input type="checkbox"/> Settlement Services <input type="checkbox"/> Account management Services <input type="checkbox"/> Information Services This field is not selectable if Correction Type is Template Correction.
Service Item Code	Enter or select the code of the Service Item. This field is not selectable if Correction Type is Template Correction.

Manual Correction – List	
Service	Shows the Service of the returned Correction.
Status	Shows the Status of the Correction.
Parent BIC	Shows the Parent BIC of the Party the Correction is applied to.
Party BIC	Shows the Party BIC of the Party the Correction is applied to.
Correction Type	Shows the Correction Type.
Period Start Date	Shows the start date of the Billing Period the Correction refers to.

Manual Correction – List	
Period End Date	Shows the end date of the Billing Period the Correction refers to
Service Category	Shows the Service Item Category. This field is not filled in if Correction Type is Manual Correction.
Service Item Code	Shows the code of the Service Item. This field is not filled in if Correction Type is Manual Correction.

Buttons

Buttons	
Search	This function enables the user to start a search according to the criteria entered. The results are displayed in a list on the same screen.
Reset	This function enables the user to set default search criteria and blanks out all optional criteria.
Invoice Data	This function enables the user to access the Invoice Data – search/list screen.

{Split book approach}

2.6.2.2 Manual Correction – Details screen

Context of Usage

This screen enables the authorised user to display the details and status of the Manual Corrections and the Template Corrections applied to a previously selected Invoice Data. The details of the selected Invoice Data and Template Correction are shown on top of the page. The Manual Corrections are displayed in a list sorted by the values of the Status, Name, Service Category, Service Item Code columns in ascending order (default setting).

This screen gives also the possibility to create, edit or delete Manual Corrections and Template Correction for the selected Invoice Data.

Screen Access

- Billing >> Invoice Data >> Search/List screen >> Click on Manual Corrections button
- Billing >> Invoice Data >> Details screen >> Click on Manual Corrections button

Privileges

To use this screen, the following Privileges are needed:

- Manual Correction Details Query
- Manage Manual Correction

Screenshot

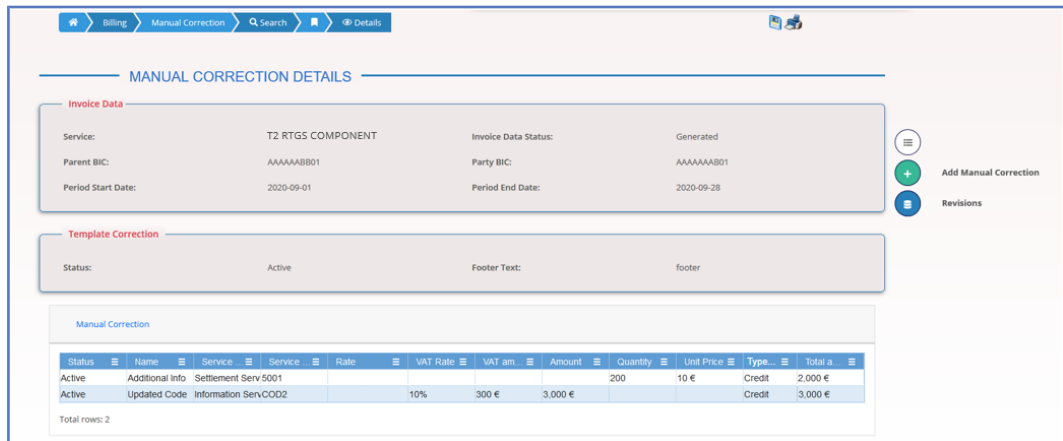

Illustration 136: **Manual Correction – Details screen** {Split book approach}

Fields

Description

Invoice Data	
Service	Shows the Service of the Invoice Data the Manual Correction is applied to.
Invoice Data Status	Shows the Status of the Invoice Data the Manual Correction is applied to.
Parent BIC	Shows the Parent BIC of the Party related to the Invoice Data the Manual Correction is applied to.
Party BIC	Shows the Party BIC of the Party related to the Invoice Data the Manual Correction is applied to.
Period Start Date	Shows the start date of the Billing Period the Invoice Data refers to.
Period End Date	Shows the end date of the Billing Period the Invoice Data refers to.
Party BIC	Shows the Party BIC of the Party related to the Invoice Data the Manual Correction is applied to.
Period Start Date	Shows the start date of the Billing Period the Invoice Data refers to.
Period End Date	Shows the end date of the Billing Period the Invoice Data refers to.
Template Correction	
Status	Shows the Status of the Template Correction.
Footer Text	Shows the Footer text included in the PDF invoice.

Manual Correction	
Status	Shows the Status of the Manual Correction.
Name	Shows the description of the Manual Correction.
Service Category	Shows the Service Item Category.
Service Item Code	Shows the code of the Service Item
Rate	Shows the percentage of correction applicable to the Amount.
VAT Rate	Shows the applied percentage of VAT.
VAT Amount	Shows the VAT Amount computed for the Manual Correction.
Amount	Shows the Amount of the correction applied on the Service Item.
Quantity	Shows the consumption related to the selected Service item.
Unit Price	Shows the Unit Price applied to the selected Quantity.
Type of correction (Credit/Debit)	Shows whether the performed Manual Correction has to be debited or to be credited to the participant.
Total Amount	Shows the total amount of the Manual Correction.

Buttons

Buttons	
Add Manual Correction	This function enables the user to create or edit a Manual Correction for the selected Invoice Data. If the status of the selected Invoice Data is set to “Included in Invoice” this function is not available.
Revisions	This function enables the user to display the revisions list of the selected Manual Correction.

{Split book approach}

2.6.2.3 Manual Correction – New/Edit screen

Context of Usage

The screen “Manual Correction – New/Edit” enables the authorised user to perform Manual Correction on Invoice Data.

Manual and Template Correction are allowed only if the relevant invoice has not been created yet, or if it has been already cancelled.

This screen is relevant for ECB, CB users and Service Operator. The user can enter new data or edit existing data. Afterwards, the user can proceed further by clicking on the buttons below.

~~ECB users can insert Invoice manual corrections only for System Entity Invoices (which could be propagated to Participant invoices), while the CB users can manually correct only the Invoice Data of their Participants.~~

~~**Screen Access** Billing >> Manual Correction >> Manual Correction Details screen >> Click on Add Manual Correction button~~

~~**Privileges** To use this screen, the following Privileges are needed:~~

~~Manage Manual Correction~~

Screenshot

Illustration 137: **Manual Correction – New/Edit screen**{Split book approach}

Fields

Description

Invoice Data	
Service	Shows the Service of the Invoice Data the Manual Correction is applied to. The field is read-only.
Invoice Data Status	Shows the Status of the Invoice Data the Manual Correction is applied to.

Invoice Data	
	The field is read-only.
Parent BIC	Shows the Parent BIC of the Party related to the Invoice Data the Manual Correction is applied to. The field is read-only.
Party BIC	Shows the Party BIC of the Party related to the Invoice Data the Manual Correction is applied to. The field is read-only.
Period Start Date	Shows the start date of the Billing Period the Invoice Data refers to. The field is read-only.
Period End Date	Shows the end date of the Billing Period the Invoice Data refers to. The field is read-only.

Template Correction	
Status	Shows the status of the corresponding Template Correction if present.
Footer Text	Shows the Footer text of the corresponding Template Correction if present.
Add/Delete Template Correction	
Footer Text	Enter the Footer text to be included in the PDF invoice, in substitution to the one configured in CRDM. Required format is: max 1000x characters.

Manual Correction	
Status	Shows the status of the corresponding Manual Correction if present.
Name	Shows the description of the Manual Correction.
Service Category	Shows the Service Item Category.
Service Item Code	Shows the code of the Service Item
Rate	Shows the percentage of correction applicable to the Amount.
VAT Rate	Shows the applied percentage of VAT.
VAT Amount	Shows the new Computed VAT Amount.

Manual Correction	
Amount	Shows the Amount of the correction applied on the Service Item.
Quantity	Shows the consumption related to the selected Service item.
Unit Price	Shows the Unit Price applicable to the selected Quantity.
Type of correction (Credit/Debit)	Shows whether the performed Manual Correction has to be debited or to be credited to the participant.
Total Amount	Shows the total amount of the Manual Correction.
Add/Delete Manual Correction	
Name	Enter the description of the Manual Correction. This field is mandatory in create mode. Required format is: max. 35x characters. Reference for error message: <input type="checkbox"/> DBC5003
Service Category	Select the Service Category from the possible values: <input type="checkbox"/> Settlement Services <input type="checkbox"/> Account management Services <input type="checkbox"/> Information Services This field is mandatory in create mode.
Service Item Code	Enter a new Code or select the code of the Service Item from the list of the already existing Service Item Codes. This field is mandatory in create mode. Required format is: max. 4x characters. Reference for error message: <input type="checkbox"/> DBC5001 <input type="checkbox"/> DBC5003
Rate	Enter the percentage of correction applicable to the Amount. This field is not allowed if an already existing Service Item Code is selected. Required format is: Percentage.
VAT Rate	Enter the percentage of VAT rate to be applied.

Manual Correction	
	<p>This field is not allowed if an already existing Service Item Code is selected.</p> <p>Required format is: Percentage.</p>
VAT Amount	<p>Shows the Computed VAT Amount.</p> <p>This field is read only.</p> <p>It is equal to Amount times the VAT Rate defined for the selected Service Item if an already existing Service Item Code is selected.</p> <p>It is equal to Amount times the VAT Rate if a new Service Item Code is entered.</p> <p>Displayed format is: amount with four decimals.</p>
Amount	<p>Enter the Amount of the correction to be applied on the Service Item.</p> <p>Only one among Amount and Quantity fields must be defined.</p> <p>Required format is: amount with four decimals.</p>
Quantity	<p>Enter the consumption related to the selected Service item.</p> <p>Only one among Amount and Quantity fields must be defined.</p> <p>Required format is: Integer.</p> <p>Reference for error message:</p> <p><input type="checkbox"/> DBC5001</p>
Unit Price	<p>Enter the Unit Price applicable to the selected Quantity.</p> <p>This field is allowed only if Quantity is filled in.</p> <p>Required format is: amount with four decimals.</p> <p>Reference for error message:</p> <p><input type="checkbox"/> DBC5001</p>
Type of correction (Credit/Debit)	<p>Select whether the performed Manual Correction has to be debited or to be credited to the participant.</p> <p>Possible values:</p> <p><input type="checkbox"/> Credit</p> <p><input type="checkbox"/> Debit</p>

Manual Correction	
	This field is mandatory in create mode.
Total Amount	<p>Shows the total amount of the Manual Correction.</p> <p>It is equal to Amount if Rate is not filled in.</p> <p>It is equal to the Rate percentage of Amount if both are filled in.</p> <p>It is blank if only Quantity is filled in.</p> <p>It is equal to Quantity times Unit Price if both are filled in.</p> <p>The field is read-only.</p> <p>Displayed format is: amount with two decimals.</p>
Propagation	
Filter BIC	<p>Enter the BIC of the party to filter the 'Parties' to be selected for Manual Correction Propagation.</p> <p>Required format is: max. 11x characters.</p> <p>This field is available only for ECB users.</p>
Parent BIC	<p>Shows the Parent BIC of the party (i.e. the Party BIC of the Party related to the Invoice Data).</p> <p>This field is available only for ECB users.</p>
Party BIC	<p>Shows the Party BIC of the party.</p> <p>Select one or more BIC to link the Manual Correction to the Invoice Data of the selected Participant.</p> <p>The list contains the Party BIC of the Participants belonging to the datascope of the party to be charged related to the Invoice Data.</p> <p>This field is available only for ECB users.</p> <p>Reference for error message:</p> <ul style="list-style-type: none"> <input type="checkbox"/> DBC5005 <input type="checkbox"/> DBC5006 <input type="checkbox"/> DBC5007
<input type="checkbox"/> Manual Correction	<ul style="list-style-type: none"> <input type="checkbox"/> Select the couple Manual Correction Name, Service Item Code from the existing Manual Corrections defined for the selected Invoice Data. <input type="checkbox"/> This field is mandatory. <input type="checkbox"/> This field is available only for ECB users.

Manual Correction	
	<p>Reference for error message:</p> <ul style="list-style-type: none"> <input type="checkbox"/> DBC5005 <input type="checkbox"/> DBC5006 <input type="checkbox"/> DBC5007

Buttons

<input type="checkbox"/> Submit Row	<p><input type="checkbox"/> This function enables the user to add or update an item in the related list using the values inserted in the related fields.</p> <p>Reference for error message:</p> <ul style="list-style-type: none"> <input type="checkbox"/> DBC5001 <input type="checkbox"/> DBC5002 <input type="checkbox"/> DBC5003 <input type="checkbox"/> DBC5004 <input type="checkbox"/> DBC5005 <input type="checkbox"/> DBC5006 <input type="checkbox"/> DBC5007
<input type="checkbox"/> Delete Row	<ul style="list-style-type: none"> <input type="checkbox"/> This function enables the user to remove the selected item from the related list. <input type="checkbox"/> If the status of the selected Manual Correction is already set to ‘Deleted’, this function is not available.
<input type="checkbox"/> Reset	<input type="checkbox"/> This function enables the user to set all fields to default value and blanks out all optional fields.
<input type="checkbox"/> Cancel	<input type="checkbox"/> This function enables the user to cancel the process and return to the previous screen.

{Split book approach}

2.6.3 PDF Invoice

2.6.3.1 PDF Invoice – Search/List screen

Context of Usage

This screen enables the authorised user to display the list of Invoices that have been created for each billing period. The result is returned on the basis of the entered criteria in a list, which is sorted by the values of the Service, Parent BIC, Party BIC, Invoice Number, Due Date columns in ascending order (default setting).

The content of the list depends on the authorised user that is performing the query:

- Operators can see all Invoices;
- ECB users can see all the System Entity Invoices (identified by a CB or CSD Party BIC);
- CB users can see their own Invoice of the System Entity (identified by a CB Party BIC) and all the Participant Invoices (identified by Participants Party BICs) related to their community;
- CSD users can see their own Invoice of the System Entity (identified by a CSD Party BIC);
- Participants users can see their own Participant Invoices (identified by Participants Party BICs).

This screen gives also the possibility to view and download more than one PDF Invoice at the same time by means of a compressed file containing all the desired Invoices.

Screen Access

- Billing >> PDF Invoice >> Search

Privileges

- To use this screen, the following Privileges are needed:
- Manage Billing Data

Screenshot

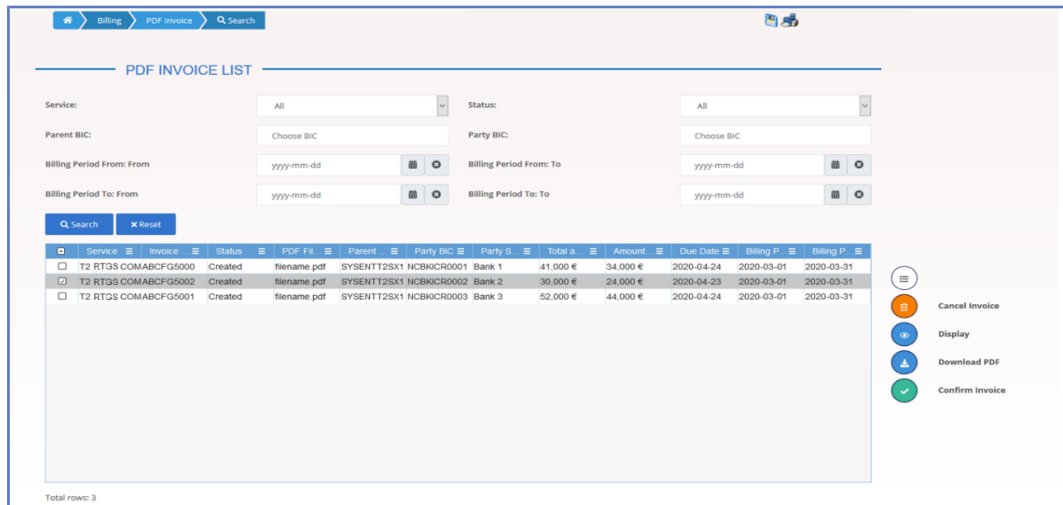

Illustration 138: PDF Invoice – search/list screen (Split book approach)

Fields

Description

PDF Invoice – Search Criteria	
Service	<p>Select the Service from the possible values:</p> <ul style="list-style-type: none"> <input type="checkbox"/> All (default value) <input type="checkbox"/> TIPS <input type="checkbox"/> T2 RTGS COMPONENT <input type="checkbox"/> ECMS <input type="checkbox"/> T2S <p>The Service “T2 RTGS COMPONENT” is meant as T2 Service.</p>
Status	<p>Select the Status of the Invoice from the possible values:</p> <ul style="list-style-type: none"> <input type="checkbox"/> All (default value) <input type="checkbox"/> Sent <input type="checkbox"/> Cancelled <input type="checkbox"/> Payment sent
Parent BIC	<p>Enter or select the Parent BIC of the Party to be charged.</p> <p>Required format is: max. 11 characters (SWIFT-x).</p>
Party BIC	<p>Enter or select the Party BIC of the Party to be charged.</p> <p>Required format is: max. 11 characters (SWIFT-x).</p>
Billing Period From: From	<p>Enter or pick the lower bound of the Start date of the relevant Billing Period for which the Invoice must be searched.</p>

PDF Invoice – Search Criteria	
	Required format is: Date.
Billing Period From: To	Enter or pick the upper bound of the Start date of the relevant Billing Period for which the Invoice must be searched. It must be greater than the “Billing Period From: From”. Required format is: Date.
Billing Period To: From	Enter or pick the lower bound of the End date of the relevant Billing Period for which the Invoice must be searched. Required format is: Date.
Billing Period To: To	Enter or pick the upper bound of the End date of the relevant Billing Period for which the Invoice must be searched. It must be greater than the “Billing Period To: From”. Required format is: Date.

PDF Invoice – List	
Service	Shows the Service of the returned Invoice.
Invoice Number	Shows the identification of the Invoice.
Status	Shows the Status of the returned Invoice.
PDF File Name	Shows the File Name of the PDF containing the returned Invoice.
Parent BIC	Shows the Parent BIC of the Party to be charged in the specified Billing Period.
Party BIC	Shows the Party BIC of the Party to be charged in the specified Billing Period.
Party Short Name	Shows the Short name of the Party to be charged.
Total Amount	Shows the Total Amount (VAT included) of the returned Invoice.
Amount without VAT	Shows the Total Amount (no VAT included) of the returned Invoice.
Due Date	Shows the Due Date of the returned Invoice.
Billing Period From	Shows the start date of the Billing Period.
Billing Period To	Shows the end date of the Billing Period.

Buttons

Search	This function enables the user to start a search according to the criteria entered. The results are displayed in a list on the same screen.
Reset	This function enables the user to set default search criteria and blanks out all optional criteria.
Display	This button allows to display the selected Invoice in PDF format.
Download PDF	This button allows to download one or more than one PDF Invoices, after selecting them.
Confirm Invoice	This button allows to change the status of the selected Invoice from “Created” to “Sent”. If the status of the selected Invoice is already set to “Cancelled”, “Sent” or “Payment sent”, this function is not available. Only the Service Operator can Confirm an Invoice.
Cancel Invoice	This button allows to change the status of the selected Invoice from “Created” or “Sent” to “Cancelled”. If the status of the selected Invoice is already set to “Cancelled” or “Payment sent”, this function is not available. Only the Service Operator can Cancel an Invoice.

{Split book approach}

2.6.4 Services

2.6.4.1 Outbound Messages - Search/List screen

Context of Usage

This screen contains a number of search fields. By inputting the relevant data, you can search for subscribed outbound messages and those sent compulsory. The search result will be displayed in a list, which is sorted by the values of the ‘Delivery Date and Time’ column in descending order (default setting). Only messages subscribed via message subscription rules and those messages compulsory sent will be displayed. After selecting an entry, you can proceed further by clicking on the buttons below. Users can see Outbound Messages under their datascope.

There is no usage restriction for this screen.

Screen Access **Billing >> Services >> Outbound Messages >> Search**

Privileges **To use this screen, the following Privileges are needed:**

- Outbound Message List Query**
- Outbound Message Details Query**

Screenshot

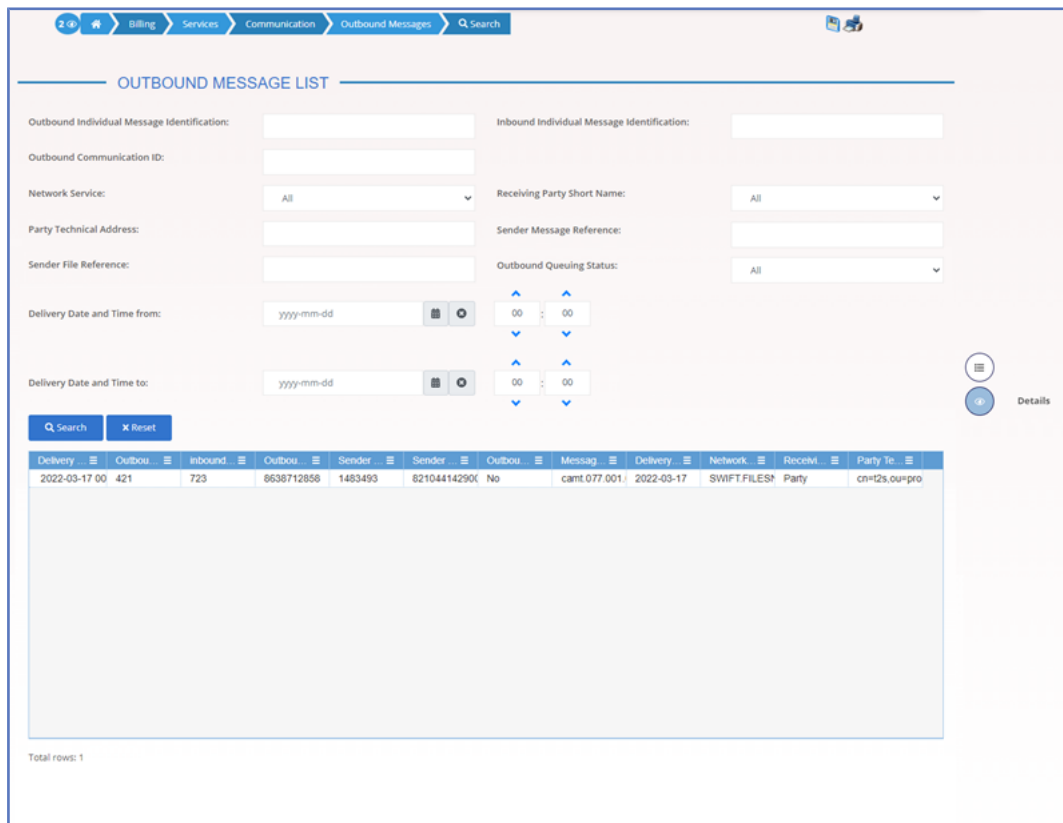

Illustration 139: **Outbound Messages – search/list screen** {Split book approach}

Fields

Description

Outbound Message – Search Criteria	
Outbound Individual Message Identification	Enter the identification of the outbound individual message. Required format is: max. 35x characters.
Outbound Communication ID (Service Operator only)	Enter the technical ID outbound communication. Required format is: max. 16x characters.
Network Service	Select the name of the network service.
Receiving Party Short Name	Enter or select the short name of the receiving party. Required format is: max. 35x characters.
Party Technical Address	Enter the technical address (i.e. distinguished name) of the receiving party.

Outbound Message – Search Criteria	
	Required format is: max. 256 characters (UTF-8 except '<', '>', '&')
Sender Message Reference	Enter the identification of the message as assigned by the message sender. Required format is: max. 35x characters.
Outbound Queuing Status	Select the outbound queuing status of the message from the possible values: <input type="checkbox"/> True <input type="checkbox"/> False <input type="checkbox"/> All (default value)
Delivery Date and Time from	Enter or pick the lower bound of the search range for the calendar date and time of the system entry of the outbound message. The 'Delivery Date and Time from' date and time must be a valid calendar date/time earlier than the 'Delivery Date and Time to' date and time. This field is mandatory. Required format is: YYYY-MM-DD hh:mm:ss
Delivery Date and Time to	Enter or pick the upper bound of the search range for the calendar date and time of the system entry of the outbound message. The 'Delivery Date and Time to' date and time must be a valid calendar date/time later than the 'Delivery Date and Time from' date and time. This field is mandatory. Required format is: YYYY-MM-DD hh:mm:ss
Outbound Messages – List	
Delivery Timestamp	Shows the date and time when the message was delivered.
Outbound Individual Message Identification	Shows the identification of the outbound individual message.
Outbound Communication ID (Service Operator only)	Shows the technical identification of the outbound communication.

Outbound Message – Search Criteria	
Sender Message Reference	Shows the identification of the outbound message as assigned by the message sender.
Outbound Queuing Status	Shows the outbound queuing status of the message.
Message Type	Shows the ISO 20022 request type of the message.
Delivery Business Date	Shows the business date when the related service started the delivery of the message.
Network Service	Shows the name of the network service.
Receiving Party Short Name	Shows the short name of the receiving party.
Party Technical Address – Sender	Shows the technical address (i.e. distinguished name) of the receiving party.

Buttons

Search	This function enables the User to start a search according to the criteria entered. The results are displayed in a list on the same screen.
Reset	This function enables the User to reset the selected outbound message.
Related Inbound Message	This function enables the User to display the inbound messages related to the selected outbound message.
Details	This function enables the User to display the details of the selected outbound message.

{Split book approach}

2.6.4.2 Outbound Messages - Details screen

Context of Usage

This screen displays detailed information on the selected outbound message. Only messages subscribed via message subscription rules and those messages compulsory sent will be displayed. You can check the data and proceed further by clicking on the buttons below.

There is no usage restriction for this screen.

Screen Access

- Billing >> Services >> Outbound Messages >> Outbound Messages – Search/List screen >> Click on the Details button
- Billing >> Services >> Inbound Messages >> Inbound Messages – Search/List screen >> click on the Related Outbound Messages button

- **Billing >> Services >> Inbound Messages >> Inbound Messages – Search/List screen >> click on the Search and/or Details button >> Inbound Message – Details screen >> click on the Related Outbound Messages button**

Privileges To use this screen, the following Privileges are needed:

- **Outbound Message Details Query**

Screenshot

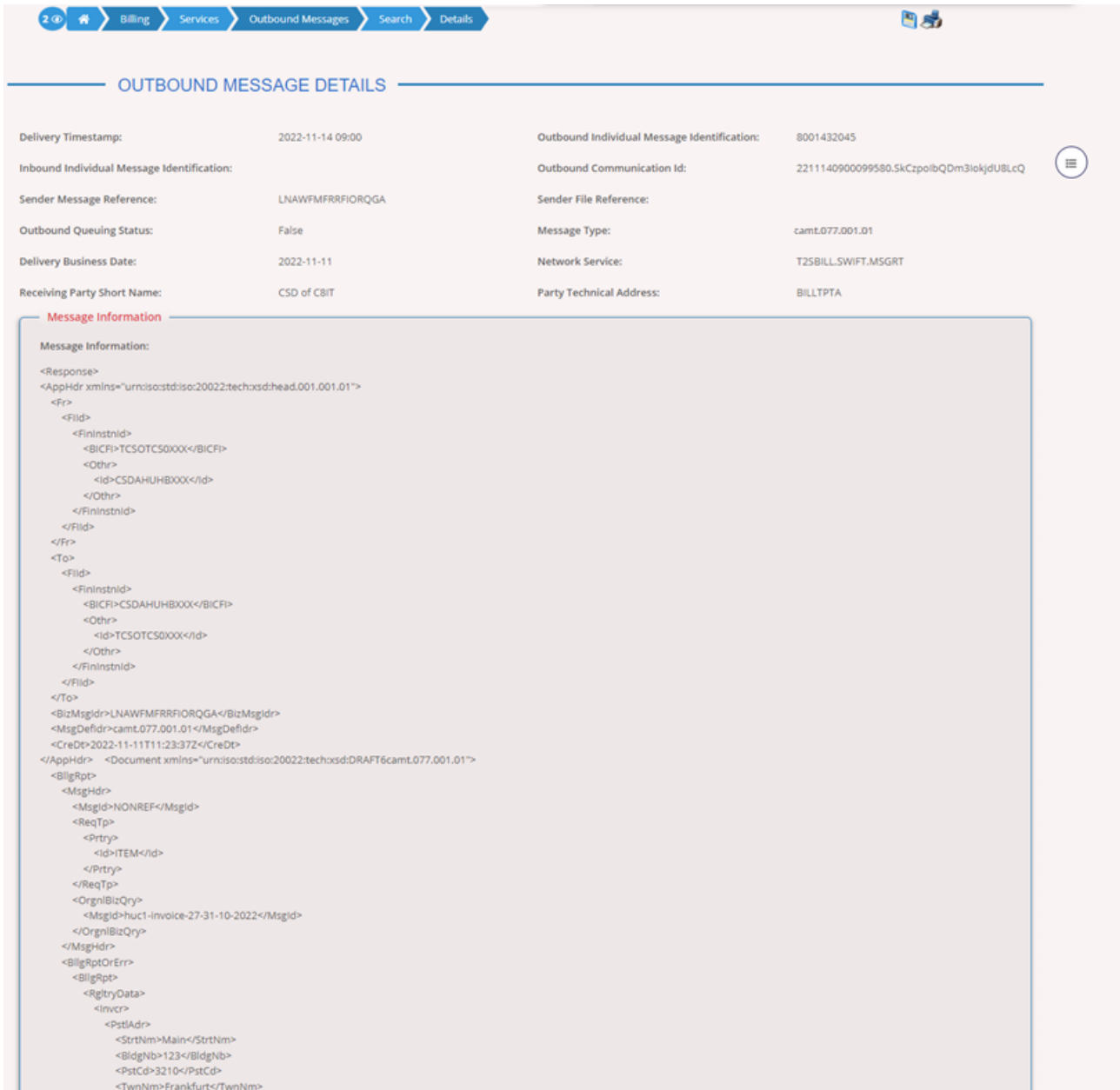

Illustration 140: Outbound Messages – details screen {Split book approach}

Fields

Description

Outbound Message – Details screen	
Delivery Timestamp	Shows the calendar date and time when the outbound message was delivered in the related service.

Outbound Message — Details screen	
Outbound Individual Message Identification	Shows the technical identification of the outbound individual message.
Outbound Communication ID (Service Operator only)	Shows the technical ID of the outbound communication.
Sender Message Reference	Shows the identification of the outbound message as assigned by the message sender.
Outbound Queuing Status	Shows the outbound queuing status of the message.
Network Service	Shows the name of the network service from the dropdown menu.
Delivery Business Date	Shows the business date when the related service started the delivery of the message.
Receiving Party Short Name	Shows the short name of the receiving party from the dropdown menu.
Party Technical Address	Shows the technical address (i.e. distinguished name) of the receiving party.
Message Information	
Message Information	Shows detailed information of the request. The content of the message is only displayed in case of small messages. Bigger messages can be displayed via the separate message export icon. Pressing this icon exports the message based on the xml document. In addition, root elements are present at the beginning and the end of the exported document. On top of the export, additional information about 'Time', 'User' and 'Screen of export' is available for documentation purpose.

{Split book approach}

2.7 Business Day Management

2.7.1 Settlement Day

2.7.1.1 Settlement Day - Search/List Screen

Context of Usage

This screen enables the user to display a list of Schedule Events of the Current Day Schedule of the specific service matching the entered criteria. The screen allows seeing the Scheduled Events of more than one service at the same time. When returning the list of Scheduled Events, the Service Operator is allowed to see the processes of a selected event, to edit or to force the completion of a selected Scheduled Event or of all Events in the same Chain of the selected Event.

When entering, the screen shows the status of the current business day for each Service.

Screen Access

- Business Day Management >> Settlement Day >> Settlement Day >> Search

Privileges

To use this screen, the following Privileges are needed:

- T2S-diary-query
- Current status of the T2S settlement day

Screenshot

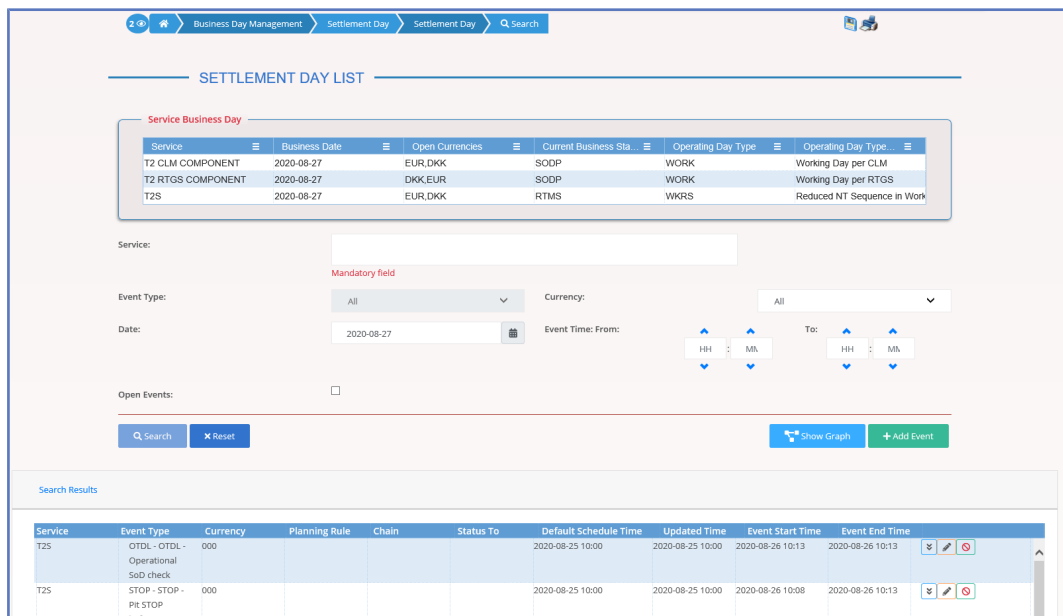

Illustration 141: Settlement Day – search/list screen (Split book approach)

Fields Description

Service Business Days	
Service	Shows the description of the Business Day related Service.

Service-Business-Days	
Business date	Shows the date of the Service business day.
Open currencies	Shows the currencies open for settlement.
Current Business Status	Shows the current Service business status.

Settlement Day – Search Criteria	
Service	Select the list of services the user can see. It must be possible to select one or more Services. This field is mandatory.
Event Type	It contains the list of event descriptions of the selected service(s) defined in the system plus the item “All”. References for error messages: <input type="checkbox"/> OSAC003 <input type="checkbox"/> OSAC006
Currency	Select a currency, “All currencies” or “No currencies”.
Date	Enter or select the date of the Events to be searched. Required format is: Date.
Event time: from	Enter the event time as lower bound of the search. Required format is: Time.
Event time: to	Enter the event time as upper bound of the search. Required format is: Time.

Settlement Day – List	
Service	Shows the service of the returned item.
Event Type	Shows the event type description of the returned item.
Currency	Shows the currency code, if any, for which the returned item is configured.
Planning Rule	Shows the planning rule of the related event.
Event Chain	Shows the chain associated to the returned item.
Status to	Shows the new status of the service at the moment the returned item is triggered.
Default Schedule Time	Shows the default schedule time of the returned item.

Settlement Day – List	
Updated Time	Shows the possible updated time of the returned item.
Event Start Time	Shows the start time of the returned item.
Event End Time	Shows the end time of the returned item.

Buttons

Buttons	
Search	<p>This function enables the user to start a search according to the filled in criteria.</p> <p>References for error messages:</p> <ul style="list-style-type: none"> <input type="checkbox"/> OSAC003 <input type="checkbox"/> OSAC005 <input type="checkbox"/> OSAC006
Reset	This function enables the user to set default search criteria and blanks out all optional criteria.

{Split book approach }

2.7.2 Calendar

2.7.2.1 Calendar - Details Screen

Context of Usage

The screen enables the user to consult the operative calendars of Target Services, specifying opening and closing days.

The system shows days, highlighted in a different colour, when the general rule has exception for specific currencies and permits the user to look at these exceptions. Week-ends are always closing days.

Default opening and closing days are defined by the system. Exception to the standard opening and closing days are defined by the Closing-Days function.

Screen Access

- Business Day Management >> Calendar >> Calendar

Privileges

To use this screen, the following Privileges are needed:

- T2S-calendar-query

Screenshot

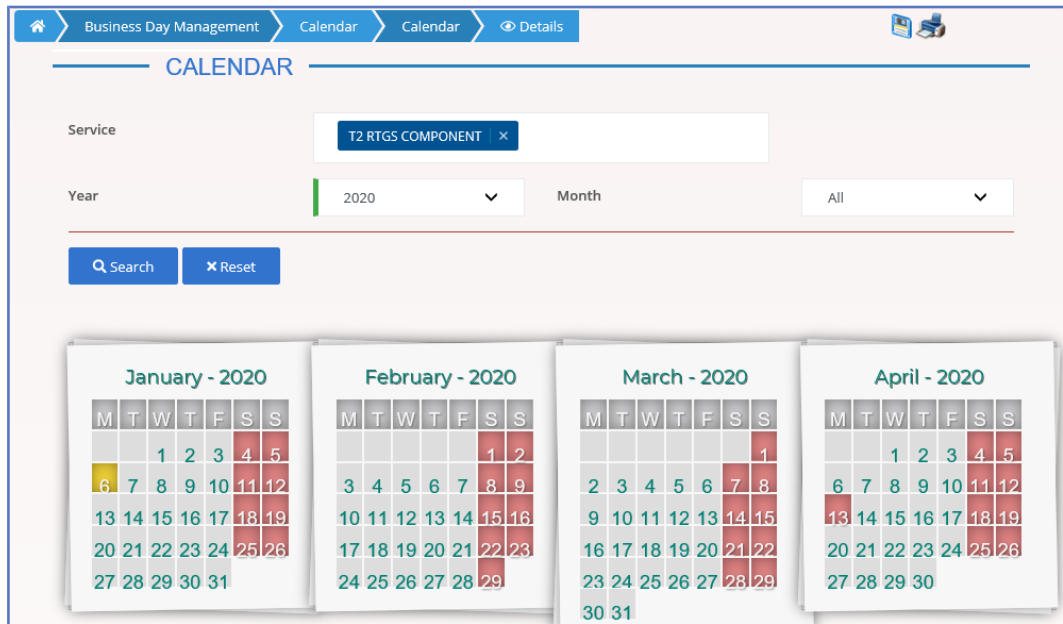

Illustration 142: **Calendar--details screen**{Split book approach}

Fields

Description

Calendar — Search Criteria	
Service	Select the Calendar-related Service.
Year	Select the year to display from the possible values: <ul style="list-style-type: none"> <input type="checkbox"/> Previous year <input type="checkbox"/> Current year (default value) <input type="checkbox"/> Following year
Month	Select the month to display from the possible values: <ul style="list-style-type: none"> <input type="checkbox"/> All (default value) <input type="checkbox"/> January <input type="checkbox"/> February <input type="checkbox"/> March <input type="checkbox"/> April <input type="checkbox"/> May <input type="checkbox"/> June <input type="checkbox"/> July <input type="checkbox"/> August <input type="checkbox"/> September <input type="checkbox"/> October <input type="checkbox"/> November <input type="checkbox"/> December

Calendar	
Month Name	Shows the name of the month and the referenced year.
Day	Shows the days of the month.
Description	Shows the opening and closing days or the days with exceptions for specific currencies. The days are marked with colours depending on their content: <ul style="list-style-type: none"> <input type="checkbox"/> Opening days are marked green <input type="checkbox"/> Closing days are marked red <input type="checkbox"/> Currency exceptions are marked yellow Further information is available via 'mouse-over', i.e. the list of currency exceptions for a specific day and the closure reasons.
Currency	Shows the currencies which are not available for cash settlement for the Services on the selected day.
Closure Reason	Shows the reason why a service is closed on the selected day.

Buttons

Buttons	
Search	This function enables the user to start a search according to the filled-in criteria.
Reset	This function enables the user to set default search criteria and blanks out all optional criteria.

{Split book approach}

3 User Instructions Part

3.1 General

The user instructions part comprises scenarios adapted from typical user workflows. They are grouped into related activities, called business packages, which are further grouped into categories.

Furthermore, you can find business scenarios dedicated only to the T2S operator are highlighted by the adding 'T2S operator only' in the title.

Categories

The categories are a structural element and do not contain any information.

Business Packages

The business packages define an overall task. They include an overview and a list of the business scenarios. In detail, each business package description has the same structure and contains the following elements.

Overview

The overview describes the aim and the background of the business package. It also explains the interrelation of the business scenarios.

List of Business Scenarios

This section contains a list of all business scenarios belonging to the business package.

The list is unordered if the business scenarios represent alternative ways to achieve the aim of the business package. It is ordered if the business scenarios have to be carried out sequentially. Sequential business scenarios do not necessarily have to be carried out directly after each other. The sequence only implies that 1 business scenario is a prerequisite for the following ones.

Business Scenarios

Each business scenario represents a single workflow and consists of single action steps, intermediate results and a final result. In detail, each business scenario description has the same structure and contains the following elements.

Context of Usage

The context of usage describes the aim of the business scenario and indicates whether this business scenario is mandatory or optional in order to fulfill the overall business package. It also contains the usage restrictions and the pre-requisites (excluding the privileges), if available.

Privileges

In this section, all the necessary privileges to access and use the involved screens are listed. First the privileges to access the first screen are mentioned, followed by the privileges necessary to proceed with the business scenario. Afterwards, the privileges for the following screens are mentioned in the same order.

Reference

This section lists all references to the screens involved, in order of their appearance in the business scenario.

Instructions Each workflow is described from the start to the end, beginning with the access to the starting screen. The instructions involve a number of separate steps which lead you through a series of screens and actions. Each action step is focused on 1 single action. Intermediate results are included and the instructions end with a final result. Possible alternatives and repetitions are highlighted with a notice sign.



Example

1. Action step 1
 2. Action step 2
 - ➔ Intermediate result
 3. Action step 3
 - ➔ Result
-

3.2 Communication

3.2.1 Usage of Broadcasts

Overview This business package describes the creation of a new broadcast and how to view existing broadcasts.

To handle broadcasts, carry out the business scenario relevant to you from the list below.

- Business Scenarios**
- Create a new broadcast [[▶ 706](#)]
 - View a broadcast [[▶ 707](#)]

3.2.1.1 Create a New Broadcast

Context of Usage This business scenario describes the creation of a new broadcast in T2S. A broadcast is an information message simultaneously available to a selected group of T2S participants. It can either be a general notification or an operational notification of a planned event in the T2S system. A broadcast can be sent to all parties linked to a system entity.

Privileges To carry out this business scenario, you need the following privileges:

- Broadcast query
- New broadcast

References Further information on screens involved can be found in the screen reference part:

- Broadcasts – search/list* screen [[▶ 617](#)]

- Instructions**
- *Broadcast – new* screen [▶ 622]
 - 1. Go to the *broadcasts – search/list* screen:
Services >> Communication >> Broadcasts
 - 2. Click on the *new* button.
 - ⇒ The *broadcast – new* screen is displayed.
 - 3. Enter all mandatory information on the screen.



Alternatives

To set all field to default value and blank out all optional fields, click on the *reset* button.

To cancel the process and return to the previous screen, click on the *cancel* button.

- 4. Click on the *submit* button.
- 2. Enter your PIN for digital signature purposes (NRO).
 - ➔ A new broadcast has been created.

3.2.1.2 View a Broadcast

Context of Usage

This business scenario describes how to search for broadcasts and to view detailed information on a broadcast.



Hint

A user may only view broadcasts until their validity elapses. The respective expiration date is automatically set to the current business date of creation + three business days.

Privileges

To carry out this business scenario, you need the following privilege:

- Broadcast query

References

Further information on screens involved can be found in the screen reference part:

- *Broadcasts – search/list* screen [▶ 617]
- *Broadcast – details* screen [▶ 620]

Instructions

1. Go to the *broadcasts –search/list* screen:
Services >> Communication >> Broadcasts
2. Enter the relevant search criteria known to you (e.g. date, subject etc.).
3. Click on the *search* button.
 - ⇒ The search result is displayed in a list on the same screen.

⇒ If the search retrieves only one record, the *broadcast – details* screen is displayed directly.



Alternative

To set all fields to default value and blank out all optional fields, click on the *re-set* button.

4. Select the broadcast you would like to view in detail by clicking on an entry in the list.
 5. Click on the *details* button.
- ➔ The *broadcasts – details* screen is displayed for the selected record.

3.2.2 Monitoring of Communication

Overview

This business package describes the monitoring of incoming and outgoing files or messages.

It enables you to resend outgoing communication or to check the incoming and outgoing files or messages (e.g. hold/release instructions, settlement instructions, amendment cash instructions) to/from T2S.

To monitor your communication, carry out the business scenarios relevant to you from the list below:

Business Scenarios

- Resend communication [▶ 708]
- View inbound communication [▶ 709]
- View outbound communication [▶ 710]

3.2.2.1 Resend Communication

Context of Usage

This business scenario describes how to resend communication in case you detect a gap. You can send already sent outbound messages by using a T2S message reference, a message sequence or a range of message sequences again. You may also resend outbound files by entering a sender file reference. This might be necessary if an outbound message or outbound file was lost.

Resending communication is one option for the monitoring of communication.

In order to resend messages or files the same privileges are required as for the initial message or file.

Privileges

To carry out this business scenario, you need the following privilege:

- Resend communication

Reference

Further information on screens involved can be found in the screen reference part:

- Instructions**
- Resend communication* screen [▶ 658]
 - 1. Go to the *resend communication* screen:
Services >> Communication >> Resend Communication
 - 2. Enter all mandatory information about the message or file you want to resend in the 'Resend Communication' frame.



Alternative

To set all fields to default value and blank out all optional fields, click on the *reset* button.

-
- 3. Click on the *submit* button.
 - ➔ You have resent one or more outbound messages or files.

3.2.2.2 View Inbound Communication

Context of Usage This business scenario describes how to search for inbound messages and files and to view detailed information on these business items.

Viewing inbound communication is one option for the monitoring of communication.

This business scenario is not relevant for CSD participant and payment bank users.

Privileges To carry out this business scenario, you need the following privileges:

- Inbound message list query
- Inbound message details query
- Inbound files list query
- Inbound files details query

Reference Further information on screens involved can be found in the screen reference part:

- Inbound messages – search/list* screen [▶ 629]
- Inbound message – details* screen [▶ 636]
- Inbound files – search/list* screen [▶ 623]
- Inbound file – details* screen [▶ 626]

- Instructions**
1. Go to the *inbound messages – search/list* screen:
Services >> Communication >> Inbound Messages
 2. Enter all search criteria known to you about the inbound message you want to view.
 3. Click on the *search* button.
- ⇒ The *inbound messages – list* screen is displayed.

- ⇒ If the search retrieves only one inbound message, the *inbound message – details* screen is displayed directly.



Alternative

You can also search for inbound files:

1. Go to the *inbound files – search/list* screen:

Services >> Communication >> Inbound Files

2. Enter all search criteria known to you about the inbound file you want to view. According to your privileges, the party and other search criteria are already filled in.
3. Click on the *search* button.

➔ The *inbound files – list* screen is displayed.

➔ If the search retrieves only one inbound file, the *inbound file – details* screen is displayed directly.



Alternative

To set all fields to default value and blank out all optional fields, click on the *reset* button.

4. Select the inbound message/file you are looking for by clicking on the entry in the list.
5. Click on the *details* button.

⇒ The *inbound message – details* screen/*inbound file – details* screen is displayed.

➔ You have viewed the details of the selected inbound message or file.



Hint

With the *inbound file* button on the *inbound message – details* screen and *related inbound messages* button on the *inbound file – details* screen you can directly access the related inbound file or message to your displayed business item.

3.2.2.3 View Outbound Communication

Context of Usage

This business scenario describes how to search for outbound messages and files and to view detailed information on these business items.

Viewing outbound communication is one option for the monitoring of communication.

This business scenario is not relevant for CSD participant and payment bank users.

Privileges

To carry out this business scenario, you need the following privileges:

- Outbound message list query
- Outbound message details query
- Outbound files list query
- Outbound files details query

Reference

Further information on screens involved can be found in the screen reference part:

- Outbound messages – search/list* screen
- Outbound message – details* screen
- Outbound files – search/list* screen
- Outbound file – details* screen

Instructions

1. Go to the *outbound messages – search/list* screen:
Services >> Communication >> Outbound Messages
2. Enter all search criteria known to you about the outbound message you want to view.
3. Click on the *search* button.
 - ⇒ The *outbound messages – list* screen is displayed.
 - ⇒ If the search retrieves only one outbound message, the *outbound message – details* screen is displayed directly.



Alternative

You can also search for outbound files:

1. Go to the *Outbound files – search/list* screen:
Services >> Communication >> Outbound Files
 2. Enter all search criteria known to you about the outbound file you want to view. According to your privileges, the party and other search criteria are already filled in.
 3. Click on the *search* button.
 - ➔ The *outbound files – list* screen is displayed.
 - ➔ If the search retrieves only one outbound file, the *outbound file – details* screen is displayed directly.
-



Alternative

To set all fields to default value and blank out all optional fields, click on the *reset* button.

4. Select the outbound message/file you are looking for by clicking on the entry in the list.
5. Click on the *details* button.
 - ⇒ The *outbound message – details* screen/*outbound file – details* screen is displayed.
 - ➔ You have viewed the details of the selected outbound message or file.



Hint

With the *outbound file* button on the *outbound message – details* screen and *related outbound messages* button on the *outbound file – details* screen you can directly access the related outbound file or message to your displayed business item.

3.3 Liquidity Transfers

3.3.1 Creation of a New Immediate Liquidity Transfer Order

Overview

This business package describes the creation of a new liquidity transfer order, in order to transfer liquidity between two T2S dedicated cash accounts or from a T2S dedicated cash account to an external RTGS account.

To create a new liquidity transfer order, carry out the business scenario relevant to you from the list below.

Business Scenarios

- Create a new immediate liquidity transfer order
- Copy an immediate liquidity transfer order

3.3.1.1 Copy an Immediate Liquidity Transfer Order

Context of Usage

This business scenario describes how to create a new immediate liquidity transfer order which can be an internal liquidity transfer (between T2S dedicated cash accounts) or an outbound liquidity transfer (from a T2S dedicated cash account to an external RTGS account) based on the data of an already executed immediate liquidity transfer.

Copying a new immediate liquidity transfer order is one option for the creation of a new liquidity transfer order.

Before you create a new immediate liquidity transfer order, check whether the account to be debited exists in T2S. In the case of an internal liquidity transfer, check also whether the account to be credited exists in T2S. In the case of an outbound liquidity transfer, check whether the account to be credited is known to T2S.

Privileges

To carry out this business scenario, you need the following privileges:

- Immediate liquidity transfer order list query
- Send new liquidity transfer

Reference

Further information on screens involved can be found in the screen reference part:

- Immediate liquidity transfer orders – search/list* screen
- Immediate liquidity transfer order – new* screen [▶ 387]

Instructions

1. Go to the *immediate liquidity transfer orders – search/list* screen:
Cash >> Liquidity >> Immediate Liquidity Transfers
2. Enter all search criteria known to you about the immediate liquidity transfer order you want to copy.
3. Click on the *search* button.
 - ⇒ A list containing the search results is displayed on the screen.
4. Select the immediate liquidity transfer order you want to copy by clicking on an entry in the list.
5. Click on the *copy* button.
 - ⇒ The *immediate liquidity transfer order – new* screen is displayed including all the information except for the user reference of the selected liquidity transfer.
6. Check all values of the immediate liquidity transfer and edit them if necessary.

**Alternatives**

To set all fields to default value and blank out all optional fields, click on the *reset* button.

To cancel the process and return to the previous screen, click on the *cancel* button.

7. Click on the *submit* button.
8. Enter your PIN for digital signature purposes (NRO).
 - ➔ A new immediate liquidity transfer order has been created.

3.4 Cash and Settlement Monitoring

3.4.1 Monitoring of Cash, Collateral and Limits Situation

Overview

This business package describes the monitoring of the cash, collateral and limits situation. The aim of this business package is to support your business monitoring. To monitor your cash, collateral and limits situation, carry out the business scenario relevant to you from the list below.

Business Scenarios

- View cash balances details and related postings [[▶ 714](#)]
- View cash balances details and related restrictions [[▶ 715](#)]
- View immediate liquidity transfer details [[▶ 716](#)]
- View standing/predefined liquidity transfer order details
- View overall liquidity [[▶ 718](#)]
- Change the limit of a payment bank
- Reimburse an outstanding intraday credit [[▶ 720](#)]

3.4.1.1 View Cash Balances Details and Related Postings

Context of Usage

This business scenario describes how to view the cash balance details and related postings allowing you to monitor and manage your balances, for instruction investigations, through queries.

It also allows you to view the instructions impacting particular cash balances during investigation and reconciliation procedures. In order to monitor the cash balances, you can query balances for a given CB or payment bank and then switch to the detailed view for a breakdown by restriction type or postings for a list of relevant instructions. To perform these queries and use these screens you must consult a party with existing T2S dedicated cash accounts.

Viewing cash balances details and related postings is one option for the monitoring of the cash, collateral and limits situation.

Privileges

To carry out this business scenario, you need the following privileges:

- T2S dedicated cash account balance query
- T2S dedicated cash account posting query

Reference

Further information on screens involved can be found in the screen reference part:

- T2S DCA balances - search/list* screen [[▶ 358](#)]
- T2S DCA balance - details* screen [[▶ 362](#)]
- T2S DCA postings - search/list* screen [[▶ 364](#)]

Instructions

1. Go to the *T2S DCA balances – search/list* screen:
Cash >> Cash Account >> Cash Account Balances
 2. Enter all search criteria known to you about the relevant cash balances you want to view.
 3. Click on the *search* button.
 - ⇒ A list containing the search results is displayed on the screen.
 - ⇒ If the search retrieves only one cash balance, the *T2S DCA balance - details* screen is displayed directly.
 4. Select the cash balance for which you want to view additional details by clicking on an entry in the list.
 5. Click on the *details* button.
 - ⇒ The *T2S DCA balance - details* screen is displayed.
 6. To display the postings related to a particular cash balance detail, select the relevant restriction type by clicking on an entry in the list.
 7. Click on the *postings* button.
 - ⇒ The *T2S DCA postings - search/list* screen is displayed, containing a list of postings including the instruction type and references along with the timestamp.
- ➔ You have viewed the cash balances details and related postings.

3.4.1.2 View Cash Balances Details and Related Restrictions

Context of Usage

This business scenario describes how to view the cash balance details and related restrictions allowing you to monitor and manage your balances, for restriction use, through queries.

It is relevant for any T2S actors within payments banks, CBs or CSDs who wish to ensure that sufficient funds are present within a particular cash balance before any potential utilisation. It also allows you to view the restriction references available for use within future instructions. In order to monitor the cash balances, you can query balances for a given CB or payment bank and then switch to the detailed view for a breakdown by restriction type or reference. To perform these queries and use these screens you must consult a party with existing T2S dedicated cash accounts.

Viewing cash balances details and related restrictions is one option for the monitoring of the cash, collateral and limits situation.

Privileges

To carry out this business scenario, you need the following privileges:

- T2S dedicated cash account balance query

- T2S dedicated cash account balance detailed restrictions query

Reference

Further information on screens involved can be found in the screen reference part:

- *T2S DCA balances - search/list* screen [▶ 358]
- *T2S DCA balance - details* screen [▶ 362]
- *Cash restriction details - search/list* screen [▶ 338]

Instructions

1. Go to the *T2S DCA balances – search/list* screen:
Cash >> Cash Account >> Cash Account Balances
⇒ The *T2S DCA balances - search/list* screen is displayed.
2. Enter all known search criteria known to you about the relevant cash balances you wish to view.
3. Click on the *search* button.
⇒ A list containing the search results is displayed on the screen.
⇒ If the search retrieves only one cash balance, the *T2S DCA balance - details* screen is displayed directly.
4. Select the cash balance for which you want to view additional details by clicking on an entry in the list.
5. Click on the *details* button.
⇒ The *T2S DCA balance – details* screen is displayed.
6. To display the restrictions related to a particular cash balance detail, select the relevant restriction type by clicking on an entry in the list.
7. Click on the *restriction references* button.
⇒ The *cash restriction details - search/list* screen is displayed, containing a list of the related restriction references and remaining, used and to be pre-empted amounts.
➔ You have viewed the cash balances details and related restrictions.

3.4.1.3 View Immediate Liquidity Transfer Order Details

Context of Usage

This business scenario describes how to monitor your immediate liquidity transfer orders which can be internal liquidity transfers (between T2S dedicated cash accounts), inbound liquidity transfers (from an external RTGS account to a T2S dedicated cash account) or outbound liquidity transfers (from a T2S dedicated cash account to an external RTGS account). Furthermore, you can obtain detailed information on a specific immediate liquidity transfer order including general, technical, party and status information.

Viewing immediate liquidity transfer order details is one option for the monitoring of cash, collateral and limits situation.

Privileges To carry out this business scenario, you need the following privileges:

- Immediate liquidity transfer order list query
- Immediate liquidity transfer order detail query

Reference Further information on screens involved can be found in the screen reference part:

- Immediate liquidity transfer orders – search/list* screen [▶ 374]
- Immediate liquidity transfer order – details* screen [▶ 382]

Instructions

1. Go to the *immediate liquidity transfer orders – search/list* screen:
Cash >> Liquidity >> Immediate Liquidity Transfers
2. Enter all search criteria known to you about the immediate liquidity transfer order you want to view. According to your privileges, the party and other search criteria are already filled in. If you have privileges for many accounts, select the search criteria taking into account the intended result.
3. Click on the *search* button.
 - ⇒ A list containing the search results is displayed on the screen.
 - ⇒ If the search retrieves only one immediate liquidity transfer order, the *immediate liquidity transfer order – details* screen is displayed directly.
4. Select any of the ‘Sort By’ criteria of the immediate liquidity transfer order to sort the list. In order to rearrange the sorted list, you can select another ‘Sort By’ criterion at any time.
 - ⇒ The screen is split into different sections according to the selected sorting criterion (e.g. per T2S dedicated account number there will be a section which contains a table with the information of the immediate liquidity transfer orders belonging to one T2S dedicated cash account number).

Transfers grouped by Dedicated Cash Account Number												
100005												
T2S Dedicated Cash Account Number	T2S Reference	Settlement Date and Time	Parent BIC	Party	Debit Cash Account Number	Credit Cash Account Number	Amount	Currency	Settlement Status	Sending Time	RTGS Status	Value Date
100005	7051	2012-11-09 15:18:18	NSBKDEFFAD1	PMBKDEFFA02	100005	100006	0.00	EUR	Not executed	...	Not applicable	2012-10-25 00:00:00
100005	7052	9999-01-01 00:00:00	NSBKDEFFAD1	PMBKDEFFA02	100005	100064	0.00	EUR	Not executed	...	Not executed	2012-10-25 00:00:00
100005	7053	2012-11-09 16:07:15	NSBKDEFFAD1	PMBKDEFFA02	100005	100064	0.00	EUR	Not executed	...	Not executed	2012-10-25 00:00:00
100005	7053	9999-01-01 00:00:00	NSBKDEFFAD1	PMBKDEFFA02	100005	100064	0.00	EUR	Not executed	...	Not executed	2012-10-25 00:00:00
100005	7051	2012-11-09 09:18:27	NSBKDEFFAD1	PMBKDEFFA02	100005	100006	0.00	EUR	Not executed	...	Not applicable	2012-10-25 00:00:00
100005	7082	2012-11-09 14:32:32	NSBKDEFFAD1	PMBKDEFFA02	100005	100006	0.00	EUR	Not executed	...	Not applicable	2012-10-25 00:00:00
100005	7127	2012-11-13 18:11:10	NSBKDEFFAD1	PMBKDEFFA02	100005	100006	0.00	EUR	Not executed	...	Not applicable	2012-10-25 00:00:00
100005	7143	9999-01-01 00:00:00	NSBKDEFFAD1	PMBKDEFFA02	100005	100006	0.00	EUR	Not executed	...	Not applicable	2012-10-25 00:00:00

100006												
T2S Dedicated Cash Account Number	T2S Reference	Settlement Date and Time	Parent BIC	Party	Debit Cash Account Number	Credit Cash Account Number	Amount	Currency	Settlement Status	Sending Time	RTGS Status	Value Date
100006	7047	2012-11-07 18:12:25	NSBKDEFFAD1	PMBKDEFFA02	100006	100005	0.00	EUR	Not executed	...	Not applicable	2012-10-25 00:00:00
100006	7064	2012-11-09 12:55:07	NSBKDEFFAD1	PMBKDEFFA02	100006	100005	0.00	EUR	Not executed	...	Not applicable	2012-10-25 00:00:00

5. Select the immediate liquidity transfer for which you want to view the details by clicking on an entry in the list.
6. Click on the *details* button.
 - ⇒ The *immediate liquidity transfer order – details* screen is displayed.
- ➔ You have viewed the details of the selected immediate liquidity transfer order.

3.4.1.4 View Overall Liquidity

Context of Usage

This business scenario describes how to view the overall liquidity if you wish to monitor cash through queries. This is mainly relevant for treasurers of credit providers or credit consumers, but also for T2S actors within payments banks, CBs or CSDs enquiring about cash balances and limits.

In order to monitor the cash situation, you can view the overall liquidity for a given CB or payment bank and then switch to the detailed view to view the components of the available liquidity. You then have the option to view the limit utilisation for the same credit consumer(s) to identify the collateral limits which are soon reached and those which are unused. You can also view the cash forecast for the same credit consumer(s) to identify any potential lack of cash. You may then react to the overall liquidity by any necessary increases or decreases to your cash balances or limits.

To perform these queries and use these screens you must be a user of a party which is a credit consumer or credit provider with existing T2S dedicated cash accounts and their associated limits.

Privileges

To carry out this business scenario, you need the following privileges:

- T2S overall liquidity query
- Limit utilisation query
- Limit utilisation journal query
- Cash forecast query

Reference

Further information on screens involved can be found in the screen reference part:

- Overall liquidity – search/list* screen [▶ 397]
- Limit utilisation – search/list* screen [▶ 349]
- Limit utilisation journal – search/list* screen [▶ 353]
- Cash forecast – search/list* screen [▶ 324]
- Cash forecast – details* screen [▶ 332]

Instructions

1. Go to the *overall liquidity – search/list* screen:
Cash >> Liquidity >> T2S Overall Liquidity
2. Enter the relevant party and parent BIC for which you want to view liquidity information.



Hint

If you are a CB user, you can restrict the view to one payment bank by entering its party BIC.



Alternative

To set all fields to default value and blank out all optional fields, click on the *re-set* button.

3. Click on the *search* button.
 - ⇒ An overview list containing the the limit, its utilisation and available liquidity per party is displayed on the screen.
4. To display all the components of the available liquidity, those related to collateral as well as those related to cash balances, click on the *detailed list* button.
 - ⇒ A detailed list is displayed on the screen, containing the collateral value, available cash, blocked cash and reserved cash. The available liquidity of the previous screen is calculated as the sum of the cash balances and the minimum of the auto-collateralisation headroom (difference between the auto-collateralisation limit and its utilisation) and the collateral value.
5. To focus on the components related to collateral, go to the *limit utilisation – search/list* screen:
Cash >> Cash Accounts >> Limit Utilisations
6. Enter the same party and parent BIC as in step 2.
7. Click on the *search* button.
 - ⇒ A list containing the search results is displayed on the screen showing the credit consumers' limit, utilisation and headroom for each credit provider and T2S dedicated cash account.
8. To display the journal of the collateral usage, select the relevant account by clicking on an entry in the list.
9. Click on the *journal of limit utilisation* button.
 - ⇒ The *limit utilisation journal – search/list* screen is displayed, showing the impact of each instruction on the limit utilisation and headroom.
10. To focus on the components related to the cash balances, go to the *cash forecasts – search/list* screen:
Cash >> Cash Accounts >> Cash Forecasts
11. Enter the same party and parent BIC as in step 2 as well as all other mandatory information.
12. Click on the *search* button.
 - ⇒ A list containing the search results is displayed, containing the cash forecast reflecting the sum of the projected cash balance and outstanding collateral for each party.

13. To display the details of the cash forecast, select the relevant cash forecast by clicking on an entry in the list.
14. Click on the *details* button.
 - ⇒ The *cash forecast – details* screen is displayed, showing the global cash forecast and the details for each T2S dedicated cash account.
 - ➔ You have obtained an overview of the different cash components allowing you to monitor the overall liquidity of your cash situation. You may then react to this overall situation by adapting your buy sell strategies, injecting cash or making limit adjustments.

3.4.1.5 Reimburse an Outstanding Intraday Credit

Context of Usage

This business scenario describes how to reimburse an outstanding intraday credit. This is done by first finding all reverse collateral instructions generated by T2S during auto-collateralisation that are still on party hold. Once identified, these reverse collateral instructions are released by changing the party hold status to false. Finding and releasing these instructions is necessary to enable their settlement. Settlement instructions put on party hold are not eligible for settlement until they are released. The settlement of these instructions results in the reimbursement of the related intraday credit.

A settlement instruction is eligible to be released for party hold if it is not cancelled, settled nor already released for party hold. You can check the status of your settlement instruction before creating the release instruction through the details screen as described in the business scenario view settlement instruction details [▶ 742].

Reimbursing an outstanding intraday credit is one option for the monitoring of cash, collateral and limits situation.

This business scenario is not relevant for CB users.

Privileges

To carry out this business scenario, you need the following privileges:

- Settlement instruction query
- Settlement instruction current status query
- Settlement instruction status audit trail query
- Release party hold settlement instruction on a securities account or on behalf of an external CSD
- Send new instruction using a specific instructing party

Reference

Further information on screens involved can be found in the screen reference part:

- Settlement instructions – search/list* screen

Instructions

- *Settlement instruction – details* screen
 - *Hold/release instruction - new* screen [▶ 126]
1. Go to the *settlement instructions - search/list* screen:
Securities >> Settlement >> Settlement Instructions
 2. Enter all mandatory search criteria enabling you to find all the reverse collateral instructions generated by T2S for auto-collateralisation that are currently on party hold. This includes all instructions where the security transaction type is either COLI or COLO and the party hold status is 'YES'.
 3. Click on the *search* button.
 - ⇒ A list containing the search results is displayed on the screen.
 - ⇒ If the search retrieves only one settlement instruction, the *settlement instruction - details* screen is displayed directly. Proceed with step 6.
 4. Select the settlement instruction on party hold you want to release by clicking on an entry in the list.
 5. Click on the *details* button.
 - ⇒ The *settlement instruction – details* screen is displayed.
 6. Check the details of the settlement instruction and click on the *hold/release* button.
 - ⇒ The *hold/release instruction – new* screen is displayed.
 7. Enter all mandatory information in the 'General' subframe.
 8. Select the 'Party Release' check box in the 'Hold/Release' subframe.

Current Hold Status	Hold Types	Release Types
Party Hold Status Hold	Party Hold <input type="checkbox"/>	Party Release <input checked="" type="checkbox"/>
CSD Hold Status Released	CSD Hold <input type="checkbox"/>	CSD Release <input type="checkbox"/>
CSD Validation Hold Status Released		CSD Validation Release <input type="checkbox"/>
CoSD Hold Status Released		CoSD Release <input type="checkbox"/>
		CoSD Rule Identification * <input type="text"/>

9. Click on the *submit* button.
 - ➔ A new release instruction for party hold has been created relating to the T2S generated settlement instruction for the reimbursement of intraday credit.

3.4.2 Monitoring of Securities Positions

Overview

This business package describes the monitoring of securities positions.

To monitor your securities positions, carry out the business scenario relevant to you from the list below.

Business Scenarios

- View current securities positions and related postings [▶ 722]
- View current securities positions and related restrictions [▶ 723]
- View historic securities positions for a specific period [▶ 725]
- View historic securities positions on a specific date [▶ 724]

3.4.2.1 View Current Securities Positions and Related Postings

Context of Usage

This business scenario describes how to view the details of securities positions and related postings allowing you to monitor and manage your positions. For reconciliation purpose, you may have to retrieve the instructions impacting particular securities positions. To achieve this, you query positions for a given CSD or settlement bank and then switch to the detailed breakdown by postings for a list of the relevant instructions.

Viewing current securities positions and related postings is one option for the monitoring of securities positions.

Privileges

To carry out this business scenario, you need the following privileges:

- Securities account position query
- Securities posting query

Reference

Further information on screens involved can be found in the screen reference part:

- Securities positions - search/list* screen [▶ 169]
- Securities position – details* screen [▶ 174]
- Securities postings - search/list* screen [▶ 82]

Instructions

1. Go to the *securities positions – search/list* screen:
`Securities >> Securities Account >> Securities Positions`
2. Enter all search criteria known to you about the securities positions you want to view.
3. Click on the *search* button.
 - ⇒ A list containing the search results is displayed on the screen, showing the securities account, ISIN, restriction type, date, currency and total quantity.
 - ⇒ If the search retrieves a single securities position, the *securities positions – details* screen is displayed directly. Proceed with step 6.
4. Select the securities position for which you want to view additional details by clicking on an entry in the list.

5. Click on the *details* button.
 - ⇒ The *securities position – details* screen is displayed, showing the details of the securities position by restriction type including the quantity to be pre-empted in the case of reservations.
 6. To view the postings related to a particular securities position detail, select the relevant restriction type by clicking on an entry in the list.
 7. Click on the *postings* button.
 - ⇒ The *securities postings – search/list* screen is displayed, showing a list of postings for the selected securities position including the instruction type and references along with the timestamp.
- ➔ You have viewed your securities positions and related postings.

3.4.2.2 View Current Securities Positions and Related Restrictions

Context of Usage

This business scenario describes how to view the details of securities positions and related restrictions allowing you to monitor and manage your positions. You can investigate your securities positions to ensure that sufficient securities are present within a particular blocked, reserved or earmarked position before any potential utilisation. You can also view the restriction references available for use within future instructions. To achieve this, you query positions for a given CSD or settlement bank and then switch to the detailed view for a breakdown by restriction type and reference.

Viewing current securities positions and related restrictions is one option for the monitoring of securities positions.

Privileges

To carry out this business scenario, you need the following privileges:

- Securities account position query
- Securities position detailed restriction details query

Reference

Further information on screens involved can be found in the screen reference part:

- Securities positions - search/list* screen [▶ 169]
- Securities position – details* screen [▶ 174]
- Securities restriction detail – search/list* screen [▶ 86].

Instructions

1. Go to the *securities positions – search/list* screen:
Securities >> Securities Account >> Securities Positions
 - ⇒ The *securities positions search/list* screen is displayed.
2. Enter all search criteria known to you about the securities positions you want to view.

3. Click on the *search* button.
 - ⇒ A list containing the search results is displayed on the screen, showing the securities account, ISIN, restriction type, date, currency and total quantity.
 - ⇒ If the search retrieves a single securities position, the *securities positions – details* screen is displayed directly. Proceed with step 6.
 4. Select the securities position for which you want to view additional details by clicking on an entry in the list.
 5. Click on the *details* button.
 - ⇒ The *securities positions – details* screen is displayed, showing the details of the securities position by restriction type including the quantity to be pre-empted in the case of reservations.
 6. To view the restrictions related to a particular securities position detail, select the relevant restriction type by clicking on an entry in the list.
 7. Click on the *restriction references* button.
 - ⇒ The *securities restriction detail – search/list* screen is displayed, showing a list of the detailed securities restrictions for the selected securities position including the related restriction reference and remaining, used and to-be pre-empted quantities.
- ➔ You have viewed your securities positions and related restrictions.

3.4.2.3 View Historic Securities Positions for a Specific Date

Context of Usage

This business scenario describes how to view the details of securities positions for a specific date allowing you to monitor and manage your positions. You can enquire about securities positions or perform investigations and reconciliations on particular positions. In order to monitor the securities positions, you can query positions for a given CSD or settlement bank and then switch to the detailed view for a breakdown by restriction type.

Viewing historic securities positions is one option for the monitoring of securities positions.

Privileges

To carry out this business scenario, you need the following privilege:

- Securities account position query

Reference

Further information on screens involved can be found in the screen reference part:

- Securities positions - search/list* screen [▶ 169]
- Securities position – details* screen [▶ 174]

- Instructions**
1. Go to the *securities positions – search/list* screen:
Securities >> Securities Account >> Securities Positions
 2. Enter all search criteria about the securities positions you want to view, including the same relevant past date in both the 'Date From' and 'Date To' fields.
 3. Click on the *search* button.
 - ⇒ A list containing the search results is displayed on the screen, showing the securities account, ISIN, restriction type, date, currency and total quantity.
 - ⇒ If the search retrieves a single securities position, the *securities position – details* screen is displayed directly.
 4. Select the securities position for which you want to view additional details by clicking on an entry in the list.
 5. Click on the *details* button.
 - ⇒ The *securities positions – details* screen is displayed, showing the details of the securities position by restriction type including the quantity to be pre-empted in the case of reservations.
 - ➔ You have viewed your historic securities positions details.

3.4.2.4 View Historic Securities Positions for a Specific Period

Context of Usage

This business scenario describes how to view the details of securities positions for a specific period allowing you to monitor and manage your positions. Using queries, you can enquire about the evolution of securities positions over a given time period while performing investigations and reconciliations on particular positions. In order to monitor the securities positions, you can query positions for a given CSD or settlement bank and then switch to the detailed view for a breakdown by restriction type.

Viewing historic securities positions for a specific period is one option for the monitoring of securities positions.

Privileges

To carry out this business scenario, you need the following privilege:

- Securities account position query

Reference

Further information on screens involved can be found in the screen reference part:

- Securities positions - search/list* screen [▶ 169]
- Securities position – details* screen [▶ 174]

Instructions

1. Go to the *securities positions – search/list* screen:
Securities >> Securities Account >> Securities Positions

2. Enter all search criteria about the securities positions you want to view, including the relevant period by specifying different past dates in the 'Date From' and 'Date To' fields.
 3. Click on the *search* button.
 - ⇒ A list containing the search results is displayed on the screen, showing the securities account, ISIN, restriction type, date, currency and total quantity.
 - ⇒ If the search retrieves a single securities position, the *securities position – details* screen is displayed directly.
 4. Select the securities position for which you want to view additional details by clicking on an entry in the list.
 5. Click on the *details* button.
 - ⇒ The *securities positions - details* screen is displayed, showing the details of the securities position by restriction type including the quantity to be pre-empted in the case of reservations.
- ➔ You have viewed your historic securities positions for a specific period.

3.5 Settlement Instructions

3.5.1 Creation of a New Settlement Instruction

Overview

This business package describes the creation of a new settlement instruction.

You can create a new settlement instruction either introducing all the necessary information, copying it from an already existing settlement instruction or responding an allegation instruction. Once the instruction has been created, you can also check its lifecycle in T2S.

To create a new settlement instruction, carry out the business scenarios in the predefined order and choose the business scenario relevant to you whenever options are given.

Business Scenarios

1. Create a new settlement instruction
 - Enter a settlement instruction [▶ 727]
 - Copy a settlement instruction [▶ 731]
 - Respond to an allegation instruction [▶ 737]
2. View instruction details
 - View settlement instruction details [▶ 742]
 - View allegation settlement instruction details [▶ 743]

3.5.1.1 Enter a Settlement Instruction

Context of Usage	<p>This business scenario describes how to create a new settlement instruction.</p> <p>Entering a new settlement instruction is one option for the creation of a new settlement instruction [▶ 726].</p> <p>This business scenario is not relevant for CB users.</p>
Privileges	<p>To carry out this business scenario, you need the following privileges:</p> <ul style="list-style-type: none"><input type="checkbox"/> Settlement instruction query<input type="checkbox"/> Settlement instruction current status query<input type="checkbox"/> Settlement instruction status audit trail query<input type="checkbox"/> Send new settlement instruction/settlement restriction on securities either on a securities account or on behalf of an external CSD<input type="checkbox"/> Send new instruction using a specific instructing party<input type="checkbox"/> Send settlement instruction with non-modifiable flag activated<input type="checkbox"/> Link to an instruction/pool reference belonging to a specific party<input type="checkbox"/> Use ISO transaction code AUTO (auto-collateralisation)<input type="checkbox"/> Use ISO transaction code BYIY (buy-in)<input type="checkbox"/> Use ISO transaction code BSBK (buy sell back)<input type="checkbox"/> Use ISO transaction code CLAI (market claim)<input type="checkbox"/> Use ISO transaction code CNCB (central bank collateral operation)<input type="checkbox"/> Use ISO transaction code COLI (collateral in)<input type="checkbox"/> Use ISO transaction code COLO (collateral out)<input type="checkbox"/> Use ISO transaction code CONV (depository receipt conversion)<input type="checkbox"/> Use ISO transaction code CORP (corporate action)<input type="checkbox"/> Use ISO transaction code ETFT (exchange traded funds)<input type="checkbox"/> Use ISO transaction code FCTA (factor update)<input type="checkbox"/> Use ISO transaction code INSP (move of stock)<input type="checkbox"/> Use ISO transaction code ISSU (issuance)<input type="checkbox"/> Use ISO transaction code MKDW (mark down)<input type="checkbox"/> Use ISO transaction code MKUP (mark up)<input type="checkbox"/> Use ISO transaction code NETT (netting)<input type="checkbox"/> Use ISO transaction code NSYN (non syndicated)<input type="checkbox"/> Use ISO transaction code OWNE (external account transfer)<input type="checkbox"/> Use ISO transaction code OWNI (internal account transfer)

- Use ISO transaction code PAIR (pair off)
- Use ISO transaction code PLAC (placement)
- Use ISO transaction code PORT (portfolio move)
- Use ISO transaction code REAL (realignment)
- Use ISO transaction code REDI (withdrawal)
- Use ISO transaction code REDM (redemption)
- Use ISO transaction code RELE (depository receipt release cancellation)
- Use ISO transaction code REPU (repo)
- Use ISO transaction code RODE (return delivery without matching)
- Use ISO transaction code RVPO (reverse repurchase agreement)
- Use ISO transaction code SBBK (sell buy back)
- Use ISO transaction code SBRE (borrowing reallocation)
- Use ISO transaction code SECB (securities borrowing)
- Use ISO transaction code SECL (securities lending)
- Use ISO transaction code SLRE (lending reallocation)
- Use ISO transaction code SUBS (subscription)
- Use ISO transaction code SWIF (switch from)
- Use ISO transaction code SWIT (switch to)
- Use ISO transaction code SYND (syndicate underwriters)
- Use ISO transaction code TBAC (TBA closing)
- Use ISO transaction code TRAD (trade)
- Use ISO transaction code TRPO (triparty repo)
- Use ISO transaction code TRVO (triparty reverse repo)
- Use ISO transaction code TURN (turnaround)
- Party hold settlement instruction on a securities account or on behalf of an external CSD
- CSD hold settlement instruction either on a securities account or on behalf of the CSD in T2S

Reference

Further information on screens involved can be found in the screen reference parts:

- Settlement instructions– search/list* screen
- Settlement instruction - new* screen [▶ 211]

Instructions

1. Go to the *settlement instructions– search/list* screen:

Securities >> Settlement >> Settlement Instructions

2. Click on the *new* button.
 - ⇒ The *settlement instruction - new* screen is displayed.
3. Enter all mandatory information about the settlement instruction you want to create in the 'General Information', and the 'Detailed Information' frame.
4. Optionally, you can enter additional information about the settlement instruction into the optional fields in all the available frames.
5. To link your settlement instruction to another instruction, click on the *add row* button to add a new link.

6. Select and add all the requested information to identify the instruction you want your settlement instruction to be linked with. Once all the information is introduced click on the *submit changes* icon in the 'Options' column.

- ⇒ The link has been added to the list.
7. If you want to add your settlement restriction on securities to a pool, enter the 'Pool Identification' field, 'Pool Instruction Counter' and the 'Pool Reference Owner BIC' field instead.



Repetition

To add more links, repeat steps 5 to 6.

8. To remove a link from the list of links to be added to the settlement instruction, click on the *delete row* icon in the 'Options' column.

⇒ The link has been deleted from the list of links.

9. To add a restriction, click on the *add row* icon to add a new restriction reference.

10. Enter the restriction reference you want to make use of and click on the *submit changes* icon in the 'Options' column.

⇒ A new restriction reference has been added to the list.



Repetition

To add more restrictions, repeat steps 9 and 10.

11. To remove a restriction reference from the list of restriction references to be added to the settlement instruction, click on the *delete row* icon in the 'Options' column.

⇒ The restriction reference has been deleted from the list of restriction references.

12. To enter additional data related to the parties involved in the settlement instruction, click on the *add row* icon in the 'Additional Receiving Parties' and/or 'Additional Delivering Parties' frames and enter all relevant information.

13. To add additional information, select the value from the 'Level 1' drop-down menu in the 'Additional Information' frame.

14. Continue this selection within the interdependent menus from the 'Level 2' drop-down menu till the 'Level 6' drop-down menu.

Each level is dependent on the next level in a successive order. The content of the select boxes varies through the different levels.

15. Once you have selected all the relevant levels, introduce the value and click on the *add row* icon.

Level 1	Level 2	Level 3
CashParties	Debtor	AlternateIdentification
Level 4	Level 5	Level 6
IdentificationType	Proprietary	Issuer

Value *

Path	Value	Options
No additional info added yet		

- ⇒ The additional information has been added to the list.



Repetition

To add more additional information paths, repeat steps 14 to 15.

16. To remove an entry from the list of additional information to be added to the settlement instruction, click on the *delete row* icon in the 'Options' column.

- ⇒ The entry has been deleted from the list of additional information.



Alternatives

To set all fields to default value and blank out all optional fields, click on the *reset* button.

To cancel the process and return to the previous screen, click on the *cancel* button.

17. Click on the *submit* button.

18. Enter your PIN for digital signature purposes (NRO).

- ➔ The new settlement instruction has been created.

3.5.1.2 Copy a Settlement Instruction

Context of Usage

This business scenario describes how to copy a settlement instruction based on an existing T2S settlement instruction in order to deliver or receive securities and/or cash between your own accounts or between one of your accounts and a counterpart's account, based on already executed settlement.

Copying an existing settlement instruction is one option for the creation of a new settlement instruction.

This business scenario is not relevant for CB users.

Privileges

To carry out this business scenario, you need the following privileges:

- Settlement instruction query
- Settlement instruction current status query

- Settlement instruction status audit trail query
- Send new settlement instruction/settlement restriction on securities either on a securities account or on behalf of an external CSD
- Send new instruction using a specific instructing party
- Send settlement instruction with non-modifiable flag activated
- Link to an instruction/pool reference belonging to a specific party
- Use ISO transaction code AUTO (Auto-Collateralisation)
- Use ISO transaction code BSBK (Buy Sell Back)
- Use ISO transaction code CLAI (Market Claim)
- Use ISO transaction code CNCB (Central Bank Collateral Operation)
- Use ISO transaction code COLI (Collateral In)
- Use ISO transaction code COLO (Collateral Out)
- Use ISO transaction code CONV (Depository Receipt Conversion)
- Use ISO transaction code CORP (Corporate Action)
- Use ISO transaction code ETFT (Exchange Traded Funds)
- Use ISO transaction code FCTA (Factor Update)
- Use ISO transaction code INSP (Move Of Stock)
- Use ISO transaction code ISSU (Issuance)
- Use ISO transaction code MKDW (Mark Down)
- Use ISO transaction code MKUP (Mark Up)
- Use ISO transaction code NETT (Netting)
- Use ISO transaction code NSYN (Non Syndicated)
- Use ISO transaction code OWNE (External Account Transfer)
- Use ISO transaction code OWNI (Internal Account Transfer)
- Use ISO transaction code PAIR (Pair Off)
- Use ISO transaction code PLAC (Placement)
- Use ISO transaction code PORT (Portfolio Move)
- Use ISO transaction code REAL (Realignment)
- Use ISO transaction code REDI (Withdrawal)
- Use ISO transaction code REDM (Redemption)
- Use ISO transaction code RELE (Depository Receipt Release Cancellation)
- Use ISO transaction code REPU (Repo)
- Use ISO transaction code RODE (Return Delivery Without Matching)

- Use ISO transaction code RVPO (Reverse Repo)
- Use ISO transaction code SBBK (Sell Buy Back)
- Use ISO transaction code SBRE (Borrowing Reallocation)
- Use ISO transaction code SECB (Securities Borrowing)
- Use ISO transaction code SECL (Securities Lending)
- Use ISO transaction code SLRE (Lending Reallocation)
- Use ISO transaction code SUBS (Subscription)
- Use ISO transaction code SYND (Syndicate Underwriters)
- Use ISO transaction code TBAC (TBA Closing)
- Use ISO transaction code TRAD (Trade)
- Use ISO transaction code TRPO (Triparty Repo)
- Use ISO transaction code TRVO (Triparty Reverse Repo)
- Use ISO transaction code TURN (Turnaround)
- Party hold settlement instruction on a securities account or on behalf of an external CSD
- CSD hold settlement instruction either on a securities account or on behalf of the CSD in T2S

Reference Further information on screens involved can be found in the screen reference part:

- Settlement instructions – search/list* screen
- Settlement instruction - details* screen
- Settlement instruction - new* screen [▶ 211]

Instructions

1. Go to the *settlement instructions – search/list* screen:
`Securities >> Settlement >> Settlement Instructions`
2. Enter the information known to you about the settlement instruction you want to copy. At least one field of the general criteria frame has to be specified to perform the search.
3. Click on the *search* button.
 - ⇒ The *settlement instructions – search/list* screen is displayed. A list containing the search results is displayed on the screen.
 - ⇒ If the search retrieves a single settlement instruction, the *settlement instruction - details* screen is displayed directly, proceed with step 6.
4. Select the settlement instruction you want to copy by clicking on an entry in the list.
5. Click on the *details* button.

- ⇒ The *settlement instruction - details* screen is displayed.
- 6. Click on the *copy row* icon.
 - ⇒ The *settlement instruction - new* screen is displayed taking by default the following fields from the original instruction: instructing party BIC, instructing party parent BIC, intended settlement date, trade date, priority, allowed modification flag, partial settlement indicator, threshold type, ISIN, securities description, securities account number, settlement quantity, settlement type, payment type code, credit/debit code, dedicated cash account, settlement amount, currency, delivering depository, delivering CSD participant information, client of the delivering CSD participant, receiving depository, receiving CSD participant, client of the receiving CSD participant.
- 7. Check if all the default values that have been copied from the settlement instruction in all the available frames are right for the new settlement instruction or modify them if needed.
- 8. Check that all mandatory information in the mandatory fields of the 'General Information' and the 'Detailed Information' frame is filled in. If not, enter all mandatory information.
- 9. Optionally, you can enter additional information about the settlement instruction into the optional fields in all the available frames.
- 10. To link your settlement instruction to another instruction, click on the *add row* icon to add a new link.

Link Type	Reference Type	Reference	Reference Owner	Options
No records found				
+				

Pool Instruction Reference:

Pool Instruction Counter:

Pool Reference Owner BIC:

- 11. Select and add all the requested information to identify the instruction you want your settlement instruction to be linked to. Once all the information is introduced click on the *submit changes* icon in the 'Options' column.

Link Type	Reference Type	Reference	Reference Owner	Options
...	...	<input type="text"/>	<input type="text"/>	✓
+				

Pool Instruction Reference:

Pool Instruction Counter:

Pool Reference Owner BIC:

- ⇒ The link has been added to the list.

12. If you want to add your settlement restriction on securities to a pool, enter the 'Pool Identification' field, 'Pool Instruction Counter' field and the 'Pool Reference Owner BIC' field instead.

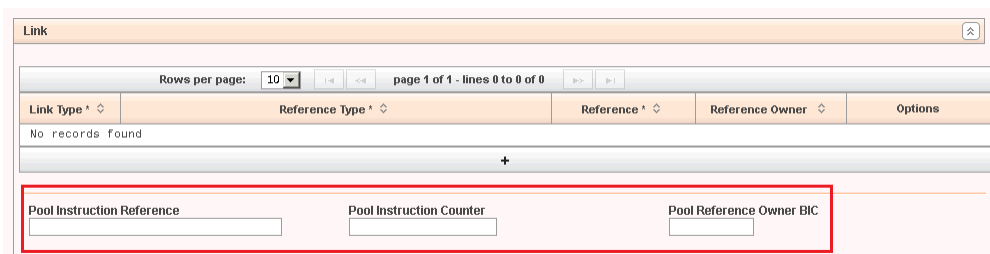

Link Type	Reference Type	Reference	Reference Owner	Options
No records found				
+				
Pool Instruction Reference	Pool Instruction Counter	Pool Reference Owner BIC		



Repetition

To add more links, repeat steps 10 to 11.

13. To remove a link from the list of links to be added to the settlement instruction, click on the *delete row* icon in the 'Options' column.

⇒ The link has been deleted from the list of links.

14. To add a restriction, click on the *add row* icon to add a new restriction reference.

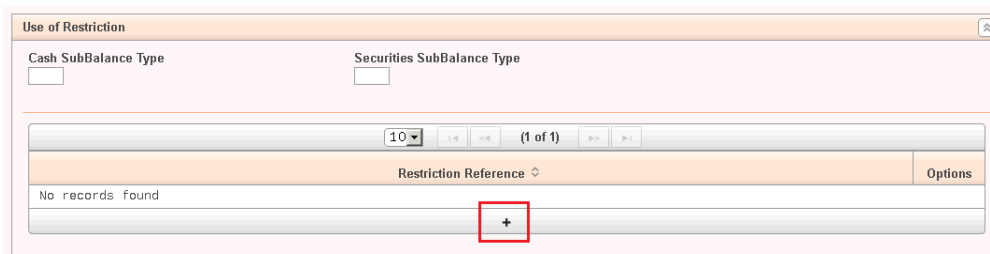

Restriction Reference	Options
No records found	
+	

15. Enter the restriction reference you want to make use of and click on the *submit changes* icon in the 'Options' column.

⇒ A new restriction reference has been added to the list.



Repetition

To add more restrictions, repeat steps 14 and 15.

16. To remove a restriction reference from the list of restriction references to be added to the settlement instruction, click on the *delete row* icon in the 'Options' column.

⇒ The restriction reference has been deleted from the list of restriction references.

17. To enter additional data related to the parties involved in the settlement instruction, click on the *add row* icon in the 'Additional Receiving Parties' and/or 'Additional Delivering Parties' frames and enter all relevant information.

18. To add additional information, select the value from the 'Level 1' drop-down menu in the 'Additional Information' frame.
19. Continue this selection within the interdependent menus from the 'Level 2' drop-down menu till the 'Level 6' drop-down menu. Each level depends on the next in a successive order. The content of the select boxes varies through the different levels.
20. Once you have selected all the relevant levels, fill in the value and click on the *add row* icon.

⇒ The additional information has been added to the list.



Repetition

To add more additional information paths, repeat steps 19 to 20.

21. To remove an entry from the list of additional information to be added to the settlement instruction, click on the *delete row* icon in the 'Options' column.

⇒ The entry has been deleted from the list of additional information.



Alternatives

To set all fields to default value and blank out all optional fields, click on the *reset* button.

To cancel the process and return to the previous screen, click on the *cancel* button.

22. Click on the *submit* button.

23. Enter your PIN for digital signature purposes (NRO).

- ➔ The new settlement instruction has been created based on a copied settlement instruction.

3.5.1.3 Respond to an Allegement Instruction

Context of Usage

This business scenario describes how to create a new settlement instruction based on the information provided by an allegement instruction. When receiving an allegement instruction, T2S indicates you that there is a settlement instruction alleged against you. To confirm it, you need to respond to the allegement by creating your settlement instruction.

Responding to an allegement instruction is one option for the creation of a new settlement instruction.

This business scenario is not relevant for CB users.

Privileges

To carry out this business scenario, you need the following privileges:

- Allegement query
- Send new settlement instruction/settlement restriction on securities either on a securities account or on behalf of an external CSD
- Send new instruction using a specific instructing party
- Send settlement instruction with non-modifiable flag activated
- Link to an instruction/pool reference belonging to a specific party
- Use ISO transaction code AUTO (auto-collateralisation)
- Use ISO transaction code BSBK (buy sell back)
- Use ISO transaction code CLAI (market claim)
- Use ISO transaction code CNCB (central bank collateral operation)
- Use ISO transaction code COLI (collateral in)
- Use ISO transaction code COLO (collateral out)
- Use ISO transaction code CONV (depository receipt conversion)
- Use ISO transaction code CORP (corporate action)
- Use ISO transaction code ETFT (exchange traded funds)
- Use ISO transaction code FCTA (factor update)
- Use ISO transaction code INSP (move of stock)
- Use ISO transaction code ISSU (issuance)
- Use ISO transaction code MKDW (mark down)
- Use ISO transaction code MKUP (mark up)

- Use ISO transaction code NETT (netting)
- Use ISO transaction code NSYN (non syndicated)
- Use ISO transaction code OWNE (external account transfer)
- Use ISO transaction code OWNI (internal account transfer)
- Use ISO transaction code PAIR (pair off)
- Use ISO transaction code PLAC (placement)
- Use ISO transaction code PORT (portfolio move)
- Use ISO transaction code REAL (realignment)
- Use ISO transaction code REDI (withdrawal)
- Use ISO transaction code REDM (redemption)
- Use ISO transaction code RELE (depository receipt release cancellation)
- Use ISO transaction code REPU (repo)
- Use ISO transaction code RODE (return delivery without matching)
- Use ISO transaction code RVPO (reverse repo)
- Use ISO transaction code SBBK (sell buy back)
- Use ISO transaction code SBRE (borrowing reallocation)
- Use ISO transaction code SECB (securities borrowing)
- Use ISO transaction code SECL (securities lending)
- Use ISO transaction code SLRE (lending reallocation)
- Use ISO transaction code SUBS (subscription)
- Use ISO transaction code SYND (syndicate underwriters)
- Use ISO transaction code TBAC (TBA closing)
- Use ISO transaction code TRAD (trade)
- Use ISO transaction code TRPO (triparty repo)
- Use ISO transaction code TRVO (triparty reverse repo)
- Use ISO transaction code TURN (turnaround)
- Party hold settlement instruction on a securities account or on behalf of an external CSD
- CSD hold settlement instruction either on a securities account or on behalf of the CSD in T2S

Reference

Further information on screens involved can be found in the screen reference part:

- Allegement instructions – search/list* screen [▶ 90]
- Allegement instruction – details* screen [▶ 94]

Instructions

□ *Settlement instruction – new screen* [▶ 211]

1. Go to the *allegement instructions – search/list* screen:
Securities >> Settlement >> Settlement Instruction Allegements
2. Enter all search criteria known to you about the allegement instruction you want to respond to.
3. Click on the *search* button.
 - ⇒ A list containing the search results is displayed on the screen.
 - ⇒ If the search retrieves only one allegement instruction, the *allegement instruction - details* screen is displayed directly. Proceed with step 6.
4. Select the allegement instruction you want to respond to by clicking on an entry in the list.
5. Click on the *details* button.
 - ⇒ The *allegement instruction - details* screen is displayed.
6. Click on the *new settlement instruction* button.
 - ⇒ The *settlement instruction - new* screen is displayed, taking by default the following fields from the original instruction: trade date, intended settlement date, cash amount, currency, securities quantity, ISIN, partial settlement indicator, securities transaction type.
7. Check if the copied default values are right for the new settlement instruction or modify them if needed.
8. Check that all mandatory fields of the ‘General Information’ and the ‘Detailed Information’ frames are filled in. If not, enter all mandatory information.
9. Optionally, you can enter additional information about the settlement instruction into the optional fields in all the available frames.
10. To link your settlement instruction to another instruction, click on the *add row* icon to add a new link.

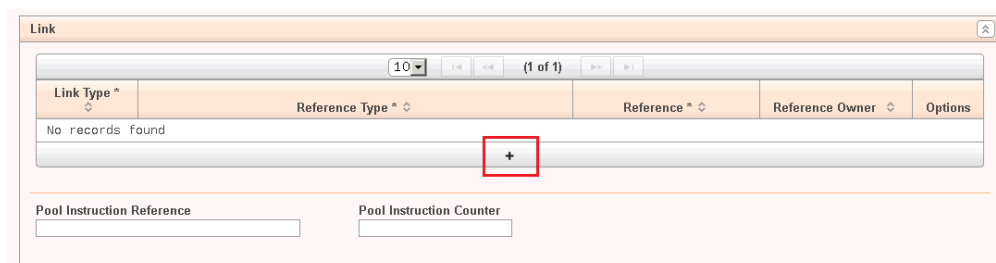

- Select and add all the requested information to identify the instruction you want your settlement instruction to be linked with. Once all the information is filled in click on the *submit changes* icon in the 'Options' column.

The screenshot shows a window titled "Link" with a table containing one row. The table has columns: Link Type, Reference Type, Reference, Reference Owner, and Options. The Options column contains a checkmark icon. Below the table, there are two input fields: "Pool Instruction Reference" and "Pool Instruction Counter".

⇒ The link has been added to the list.

- If you want to add your settlement instruction to a pool, enter the pool identification and the pool instruction counter instead.

The screenshot shows a window titled "Link" with a table that displays "No records found". Below the table, there are two input fields: "Pool Instruction Reference" and "Pool Instruction Counter".



Repetition

To add more links, repeat steps 10 to 11.

- To remove a link from the list of links to be added to the settlement instruction, click on the *delete row* icon in the 'Options' column.

⇒ The link has been deleted from the list of links.

- To add a restriction, click on the *add row* icon to add a new restriction reference.

The screenshot shows a window titled "Use of Restriction" with a table that displays "No records found". Below the table, there is a red box around a "+" icon, which is the "add row" icon.

- Enter the restriction reference you want to make use of and click on the *submit changes* icon in the 'Options' column.

⇒ A new restriction reference has been added to the list.



Repetition

To add more restrictions, repeat steps 14 and 15.

16. To remove a restriction reference from the list of restriction references to be added to the settlement instruction, click on the *delete row* icon in the 'Options' column.
 - ⇒ The restriction reference has been deleted from the list of restriction references.
17. To enter additional data related to the parties involved in the settlement instruction, click on the *add row* icon in the 'Additional Receiving Parties' and/or 'Additional Delivering Parties' frames and enter all relevant information.

18. To add additional information, select the value from the 'Level 1' drop-down menu in the 'Additional Information' frame.
19. Continue this selection within the interdependent menus from the 'Level 2' drop-down menu till the 'Level 6' drop-down menu. Each level depends on the next in a successive order. The content of the drop-down menu varies through the different levels.
20. Once you have selected all the relevant levels, enter the value and click on the *add row* icon.

- ⇒ The additional information has been added to the list.



Repetition

To add more additional information paths, repeat steps 19 to 20.

21. To remove an entry from the list of additional information to be added to the settlement instruction, click on the *delete row* icon in the 'Options' column.
 - ⇒ The entry has been deleted from the list of additional information.



Alternatives

To set all fields to default value and blank out all optional fields, click on the *reset* button.

To cancel the process and return to the previous screen, click on the *cancel* button.

22. Click on the *submit* button.

23. Enter your PIN for digital signature purposes (NRO).

➔ The new settlement instruction has been created.

3.5.1.4 View Settlement Instruction Details

Context of Usage

This business scenario describes how to view the details of a settlement instruction.

Once a settlement instruction is created in T2S it might be necessary for you to check its details to be aware of updates during the lifecycle of the settlement instruction.

Viewing settlement instruction details is optional for the creation of a new settlement instruction.

This business scenario is not relevant for CB users.

Privileges

To carry out this business scenario, you need the following privileges:

- Settlement instruction query
- Settlement instruction current status query

Reference

Further information on screens involved can be found in the screen reference part:

- Settlement instructions – search/list* screen
- Settlement instruction – details* screen

Instructions

1. Go to the *settlement instructions – search/list* screen:
Securities >> Settlement >> Settlement Instructions
2. Enter at least one general search criterion known to you about the settlement instruction for which you want to view the details.
3. Click on the *search* button.
 - ⇒ A list containing the search results is displayed on the screen.
 - ⇒ If the search retrieves only one settlement instruction, the *settlement instruction – details* screen is displayed directly.

**Alternative**

To set all fields to default value and blank out all optional fields, click on the *re-set* button.

4. Select the settlement instruction for which you want to view the details by clicking on the entry in the list.
5. Click on the *details* button.
 - ⇒ The *settlement instruction – details* screen is displayed.
 - ➔ You have viewed the settlement instruction details.

3.5.1.5 View Allegement Settlement Instruction Details

Context of Usage

This business scenario describes how to view the details of an allegement instruction. Once the allegement instruction is created in T2S it might be necessary for you to check its status.

Viewing allegement settlement instruction details is optional for the creation of a new settlement instruction.

This business scenario is not relevant for CB users.

Privileges

To carry out this business scenario, you need the following privilege:

- Allegement query

Reference

Further information on screens involved can be found in the screen reference part:

- Allegement instructions – search/list* screen [▶ 90]
- Allegement instruction - details* screen [▶ 94]

Instructions

1. Go to the *allegement instructions – search/list* screen:
Securities >> Settlement >> Settlement Instruction Allegements
2. Enter all search criteria known to you about the allegement instruction for which you want to view the details.

**Alternative**

To set all fields to default value and blank out all optional fields, click on the *re-set* button.

3. Click on the *search* button.
 - ⇒ A list containing the search results is displayed on the screen.
 - ⇒ If the search retrieves only one allegement instruction, the *allegement instruction - details* screen is displayed directly.

4. Select the allegation instruction for which you want to view the details by clicking on an entry in the list.
5. Click on the *details* button.
 - ⇒ The *allegation instruction - details* screen is displayed.
 - ➔ You have viewed the allegation settlement instruction details.

3.5.2 Creation of a New Amendment Instruction for a Settlement Instruction

Overview

This business package describes the creation of a new amendment instruction for a settlement instruction.

You can create a new amendment instruction for a settlement instruction and afterwards, you can also check the information of the amendment instruction in T2S.

To create a new amendment instruction for a settlement instruction, carry out the business scenarios in the predefined order and choose the business scenario relevant to you whenever options are given.

Business Scenarios

1. Create a new amendment instruction for a settlement instruction
 - Add a link for a settlement instruction [▶ 744]
 - Amend the partial settlement indicator for a settlement instruction [▶ 747]
 - Amend the priority for a settlement instruction [▶ 748]
 - Remove a link for a settlement instruction [▶ 750]
2. View amendment instruction for a settlement instruction details [▶ 752]

3.5.2.1 Add a Link for a Settlement Instruction

Context of Usage

This business scenario describes how to link a settlement instruction in order to settle it at the same time, after or before another settlement instruction or settlement restriction.

Adding a link for a settlement instruction is one option for the creation of an amendment instruction for a settlement instruction.

Before you add a link for your settlement instruction, check whether the settlement instruction is neither cancelled, partially settled, settled nor on CoSD hold.

You can check the status of your settlement instruction before creating the amendment instruction through the details screen as described in the business scenario view settlement instruction details [▶ 742].

The number of links that can be added per amendment instruction is unbounded.

This business scenario is not relevant for NCB users.

- Privileges** To carry out this business scenario, you need the following privileges:
- Settlement instruction query
 - Settlement instruction current status query
 - Settlement instruction status audit trail query
 - Send new instruction using a specific instructing party
 - Link to an instruction/pool reference belonging to a specific party
 - Amend process indicator of a settlement instruction / settlement restriction on securities either on a securities account or on behalf of the CSD in T2S or on behalf of an external CSD
 - Amend process indicator of a non-modifiable settlement instruction on behalf of the instructing party of the underlying instruction
- Reference** Further information on screens involved can be found in the screen reference part:
- Settlement instructions – search/list* screen
 - Settlement instruction - details* screen
 - Amendment securities instruction - new* screen [▶ 103]
- Instructions**
1. Go to the *settlement instructions – search/list* screen:
Securities >> Settlement >> Settlement Instructions
 2. Enter the relevant information about the settlement instruction you want to link.
 3. Click on the *search* button.
 - ⇒ The *settlement instructions – search/list* screen is displayed.
 - ⇒ If the search retrieves a single settlement instruction, the *settlement instruction - details* screen is displayed directly. Proceed with step 6.
 4. Select the settlement instruction you want to amend by clicking on an entry in the list.
 5. Click on the *details* button.
 - ⇒ The *settlement instruction - details* screen is displayed.
 6. Click on the *amendment instruction* button in the button bar.
 - ⇒ The *amendment securities instruction - new* screen is displayed.
 7. Enter all mandatory information in the 'General' frame.
 8. Select the *linkage information* radio button, located on the lower center side of the *amendment securities instruction - new* screen.



Amendment Type

Priority Linkage Information Partial Settlement Indicator

⇒ The 'Linkage Information' and the 'Link' frames are displayed.

9. Select the *link* radio button to add a link.

The screenshot shows a window titled 'Linkage Information'. At the top right is a close button. Below the title bar, there are two radio buttons: 'LINK' (which is selected) and 'UNLINK'.

10. Click on the *add row* icon in the 'Link' frame to display the links related input fields.

The screenshot shows a window titled 'Link'. At the top right is a close button. Below the title bar, there is a dropdown menu set to '10' and a pagination indicator '(1 of 1)'. Below this is a table with the following columns: 'Link Type', 'Reference Type', 'Reference', 'Reference Owner', and 'Options'. The table currently contains one row with the text 'No records found'. A red box highlights a '+' icon in the 'Options' column of this row.

11. Enter the relevant information to identify the instruction you want your instruction to be linked with in the 'Link' frame and click on the *submit changes* icon in the 'Options' column.

The screenshot shows the 'Link' frame with the table from the previous step. A red box highlights the first row, which now contains input fields for 'Link Type', 'Reference Type', 'Reference', and 'Reference Owner'. In the 'Options' column, there is a submit icon (a checkmark inside a circle) and a delete icon (a circle with an 'X').

⇒ The link has been added to the list.

12. To remove an entry from the list of links to be added, click on the *delete row* icon in the 'Options' column.

⇒ The link has been deleted from the list.



Repetition

To add more links, repeat steps 10 to 11.

You can add as many links as you like.



Alternatives

To set default criteria and blank out all optional fields, click on the *reset* button.

To cancel the process and return to the previous screen, click on the *cancel* button.

13. Click on the *submit* button.

14. Enter your PIN for digital signature purposes (NRO).

➔ A new amendment instruction to add a link for a settlement instruction has been created.

3.5.2.2 Amend the Partial Settlement Indicator for a Settlement Instruction

Context of Usage

This business scenario describes how to amend the partial settlement indicator for a settlement instruction. You can create a new amendment instruction for your settlement instruction to change its partial settlement indicator and threshold type.

Amending the partial settlement indicator is one option for the creation of an amendment instruction for a settlement instruction.

Before you amend the partial settlement indicator for your settlement instruction, check whether it is neither cancelled nor settled nor on CoSD hold. In addition, partial settlement is not possible for linked settlement instructions. You can check the status of your settlement instruction before creating the amendment instruction through the details screen as described in the business scenario view settlement instruction details [▶ 742].

Privileges

To carry out this business scenario, you need the following privileges:

- Settlement instruction query
- Settlement instruction current status query
- Settlement instruction status audit trail query
- Send new instruction using a specific instructing party
- Link to an instruction/pool reference belonging to a specific party
- Amend process indicator of a settlement instruction / settlement restriction on securities either on a securities account or on behalf of the CSD in T2S or on behalf of an external CSD
- Amend process indicator of a non-modifiable settlement instruction on behalf of the instruction party of the underlying instruction

Reference

Further information on screens involved can be found in the screen reference part:

- Settlement instructions – search/list* screen
- Settlement instruction – details* screen
- Amendment securities instruction – new* screen [▶ 103]

Instructions

1. Go to the *settlement instructions – search/list* screen:
Securities >> Settlement >> Settlement Instructions
2. Enter at least one general search criterion known to you about the settlement instruction for which you want to amend the partial settlement indicator.
3. Click on the *search* button.
 - ⇒ A list containing the search results is displayed on the *settlement instructions – search/list* screen.

- ⇒ If the search retrieves a single settlement instruction, the *settlement instruction – details* screen is displayed directly. Proceed with step 6.
4. Select the settlement instruction you want to amend by clicking on an entry in the list.
 5. Click on the *details* button.

⇒ The *settlement instruction – details* screen is displayed.
 6. Click on the *amendment instruction* button, located on the lower lefthand side of the *settlement instruction – details* screen.

⇒ The *amendment securities instruction – new* screen is displayed.
 7. Click on the *partial settlement indicator* radio button, located on the lower right hand side of the *amendment securities instruction - new* screen.

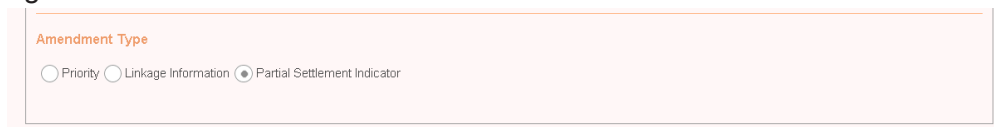

Amendment Type

Priority Linkage Information Partial Settlement Indicator

- ⇒ The *partial settlement indicator* frame is displayed.
8. Select the new partial settlement indicator from the drop-down menu.



Partial Settlement Indicator

Partial Settlement Indicator *

Partial allowed

Partial allowed

Partial not Allowed

Partial Settlement Cash Threshold allowed

Partial Settlement Quantity Threshold allowed



Alternatives

To set all fields to default criteria and blank out all optional fields, click on the *reset* button.

To cancel the process and return to the previous screen, click on the *cancel* button.

9. Click on the *submit* button.
10. Enter your PIN for digital signature purposes (NRO).

➔ A new amendment instruction to change the partial settlement indicator has been created.

3.5.2.3 Amend the Priority for a Settlement Instruction

Context of Usage

This business scenario describes how to amend the priority for a settlement instruction. You can create a new amendment instruction to amend the priority for your settlement instruction to prioritise or delay its settlement.

Amending the priority for a settlement instruction is one option for the creation of an amendment instruction for a settlement instruction.

Before you amend the priority for a settlement instruction, check whether it is neither cancelled nor settled nor on CoSD Hold. You can check the status of your settlement instruction before creating the amendment instruction, through the *details* screen as described in the business scenario view settlement instruction details [▶ 742].

This business scenario is not relevant for CB users.

Privileges

To carry out this business scenario, you need the following privileges:

- Link to an instruction/pool reference belonging to a specific party
- Settlement instruction query
- Settlement instruction current status query
- Settlement instruction audit trail query
- Send new instruction using a specific instructing party
- Amend process indicator of a settlement instruction/settlement restriction on securities either on a securities account or on behalf of the CSD in T2S or on behalf of an external CSD
- Amend process indicator of a non-modifiable settlement instruction on behalf of the instructing party of the underlying instruction

Reference

Further information on screens involved can be found in the screen reference part:

- Settlement instructions – search/list* screen
- Settlement instruction – details* screen
- Amendment securities instruction - new* screen [▶ 103]

Instructions

1. Go to the *settlement instructions – search/list* screen:
Securities >> Settlement >> Settlement Instructions
2. Enter all search criteria known to you about the settlement instruction for which you want to amend the priority.
3. Click on the *search* button.
 - ⇒ A list containing the search results is displayed on the screen.
 - ⇒ If the search retrieves only one settlement instruction, the *settlement instruction – details* screen is displayed directly. Proceed with step 6.
4. Select the settlement instruction for which you want to amend the priority by clicking on an entry in the list.
5. Click on the *details* button.
 - ⇒ The *settlement instruction – details* screen is displayed.
6. Check the current priority value and click on the *amendment instruction* button.

⇒ The *amendment securities instruction – new* screen is displayed.

7. Click on the *priority* radio button, located on the lower left-hand side of the screen.

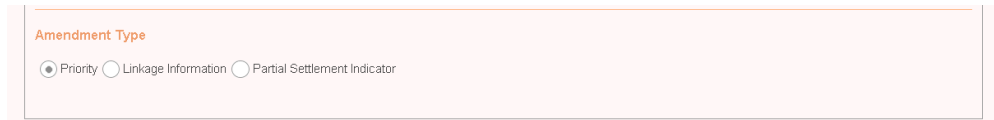

Amendment Type

Priority Linkage Information Partial Settlement Indicator

⇒ The 'Priority' frame is displayed.

8. Select the new priority from the drop-down menu.



Priority

Priority Level *

High
Normal
Reserved



Alternatives

To set default criteria and blank out all optional fields, click on the *reset* button.

To cancel the process and return to the previous screen, click on the *cancel* button.

9. Click on the *submit* button.
 10. Enter your PIN for digital signature purposes (NRO).
- ➔ A new amendment instruction to change the priority has been created.

3.5.2.4 Remove a Link for a Settlement Instruction

Context of Usage

This business scenario describes how to remove an existing link in a settlement instruction.

Removing a link for a settlement instruction is one option for the creation of a new amendment instruction for a settlement instruction.

Before you remove a link for your settlement instruction, check whether it is neither settled nor cancelled. You can check the status of your settlement instruction before creating the amendment instruction through the details screen as described in the business scenario view settlement instruction details [▶ 742].

The number of links that can be removed per amendment instruction is limited to the number of existing linkages in the settlement instruction.

If you want to modify an already existing link in your settlement instruction, you have first to remove the existing link and then add a new link to your settlement instruction.

This business scenario is not relevant for CB users.

Privileges

To carry out this business scenario, you need the following privileges:

- Settlement instruction query

- Settlement instruction current status query
- Settlement instruction status audit trail query
- Link to an instruction/pool reference belonging to a specific party
- Amend process indicator of a settlement instruction/settlement restriction on securities either on a securities account or on behalf of the CSD in T2S or on behalf of an external CSD
- Amend process indicator of a non-modifiable settlement instruction on behalf of the instructing party of the underlying instruction
- Send new instruction using a specific instructing party

Reference

Further information on screens involved can be found in the screen reference part:

- Settlement instructions – search/list* screen
- Settlement instruction – details* screen
- Amendment securities instruction – new* screen [▶ 103]

Instructions

1. Go to the *settlement instructions – search/list* screen:
Securities >> Settlement >> Settlement Instructions
2. Enter all search criteria known to you about the settlement instruction you want to amend.
3. Click on the *search* button.
 - ⇒ A list containing the search results is displayed on the screen.
 - ⇒ If the search retrieves only one settlement instruction, the *settlement instructions – details* screen is displayed directly. Proceed with step 6.
4. Select the settlement instruction you want to amend by clicking on an entry in the list.
5. Click on the *details* button.
 - ⇒ The *settlement instruction – details* screen is displayed.
6. Click on the *amendment instruction* button, located on the lower left-hand side of the screen.
 - ⇒ The *amendment securities instruction – new* screen is displayed.
7. Enter all mandatory information in the 'General' subframe.
8. Click on the *linkage information* radio button, located on the lower center side of the *amendment securities instruction – new* screen.



Amendment Type

Priority Linkage Information Partial Settlement Indicator

- ⇒ The 'Linkage Information' and 'Link' frames are displayed.

9. Select the *unlink* radio button.



⇒ The existing links of the referenced settlement instruction are displayed in the 'Link' frame below.

10. Select the link(s) to be removed from the list.



Alternatives

To set default criteria and blank out all optional fields, click on the *reset* button. To cancel the process and return to the previous screen, click on the *cancel* button.

11. Click on the *submit* button.

12. Enter your PIN for digital signature purposes (NRO).

➔ A new amendment instruction to remove a link for a settlement instruction has been created.

3.5.2.5 View Amendment Instruction for a Settlement Instruction Details

Context of Usage

This business scenario describes how to view the details of an amendment instruction for a settlement instruction. Once an amendment instruction for a settlement instruction has been created in T2S it might be necessary for you to check its details to be aware of updates during the lifecycle of the amendment instruction.

Viewing an amendment instruction for a settlement instruction is optional for the creation of a new amendment instruction for a settlement instruction.

This business scenario is not relevant for CB users.

Privileges

To carry out this business scenario, you need the following privileges:

- Maintenance for intra-position movements and settlement instructions query
- Amendment instruction query for intra-position movements and settlement instructions

Reference

Further information on screens involved can be found in the screen reference part:

- Maintenance securities instructions – search/list* screen [▶ 164]
- Amendment securities instruction – details* screen [▶ 98]

Instructions

1. Go to the *maintenance securities instructions – search/list* screen:
Securities >> Settlement >> Maintenance Securities Instructions
2. Enter all search criteria known to you about the amendment instruction for a settlement instruction for which you want to view the details.
3. Select the value 'Settlement Instruction' in the 'Instruction Type' field.

4. Select the value 'Amendment Instruction' in the 'Maintenance Instruction Type' field.



Alternative

To set all fields to default value and blank out all optional fields, click on the *reset* button.

5. Click on the *search* button.
 - ⇒ A list containing the search results is displayed on the screen.
 - ⇒ If the search retrieves only one amendment instruction for a settlement instruction, the *amendment securities instruction – details* screen is displayed directly.
 6. Select the amendment instruction for a settlement instruction for which you want to view the details by clicking on an entry in the list.
 7. Click on the *details* button.
 - ⇒ The *amendment securities instruction – details* screen is displayed.
- ➔ You have viewed the details of an amendment instruction for a settlement instruction.

3.5.3 Creation of a New Hold/Release Instruction for a Settlement Instruction

Overview

This business package describes the creation of a new hold/release instruction for a settlement instruction.

You can create a new hold/release instruction and afterwards check the information of the hold/release instruction in T2S.

To create a new hold/release instruction for a settlement instruction, carry out the business scenarios in the predefined order and choose the business scenario relevant to you whenever options are given:

Business Scenarios

1. Create a new hold instruction
 - Put a settlement instruction on party hold [[▶ 754](#)]
 - Put a settlement instruction on CSD hold [[▶ 756](#)]
2. Create a new release instruction
 - Release a settlement instruction from party hold [[▶ 758](#)]
 - Release a settlement instruction from CSD hold [[▶ 761](#)]
 - Release a settlement instruction from CoSD hold [[▶ 763](#)]
 - Release a settlement instruction from CSD validation hold [[▶ 765](#)]
3. View hold/release instruction details [[▶ 766](#)]

3.5.3.1 Put a Settlement Instruction on Party Hold

Context of Usage

This business scenario describes how to put a settlement instruction on party hold through the creation of a hold instruction. Settlement instructions put on party hold are not eligible for settlement until they are released. This is necessary if you want to prevent the settlement instruction to be settled.

Putting a settlement instruction on party hold is one option for the creation of a new hold/release instruction for a settlement instruction.

Before you create a new hold instruction for party hold, check whether the settlement instruction is eligible for party hold. A settlement instruction is eligible to be put on party hold if it is not cancelled, settled, already put on party hold nor identified as CoSD. You can check the status of your settlement instruction before creating the hold instruction through the details screen as described in the business scenario view settlement instruction details [[▶ 742](#)].

This business scenario is not relevant for CB users.

Privileges

To carry out this business scenario, you need the following privileges:

- Settlement instruction query
- Settlement instruction current status query

- Settlement instruction status audit trail query
- Party hold settlement instruction on a securities account or on behalf of an external CSD
- Send new instruction using a specific instructing party

Reference

Further information on screens involved can be found in the screen reference part:

- Settlement instructions – search/list* screen
- Settlement instruction – details* screen
- Hold/release instruction - new* screen [▶ 126]

Instructions

1. Go to the *settlement instructions – search/list* screen:
Securities >> Settlement >> Settlement Instructions
2. Enter at least one general search criterion known to you about the settlement instruction you want to put on party hold.
3. Click on the *search* button.
 - ⇒ A list containing the search results is displayed on the screen.
 - ⇒ If the search retrieves only one settlement instruction, the *settlement instruction – details* screen is displayed directly. Proceed with step 6.
4. Select the settlement instruction you want to put on party hold by clicking on an entry in the list.
5. Click on the *details* button.
 - ⇒ The *settlement instruction – details* screen is displayed.
6. Check the details of the settlement instruction and click on the *hold/release* button.
 - ⇒ The *hold/release instruction – new* screen is displayed.
7. Enter all mandatory information in the ‘General’ subframe.
8. Select the ‘Party Hold’ check box in the ‘Hold/Release’ subframe.

Current Hold Status	Hold Types	Release Types
Party Hold Status Released	Party Hold <input checked="" type="checkbox"/>	Party Release <input type="checkbox"/>
CSD Hold Status Released	CSD Hold <input type="checkbox"/>	CSD Release <input type="checkbox"/>
CSD Validation Hold Status Released		CSD Validation Release <input type="checkbox"/>
CoSD Hold Status Released		CoSD Release <input type="checkbox"/>
		CoSD Rule Identification <input type="text"/>



Alternative

To set all fields to default value and blank out all optional fields, click on the *reset* button.

To cancel the process and return to the previous screen, click on the *cancel* button.

9. Click on the *submit* button.

10. Enter your PIN for digital signature purposes (NRO).

➔ A new hold instruction for party hold has been created.

3.5.3.2 Put a Settlement Instruction on CSD Hold

Context of Usage

This business scenario describes how to put a settlement instruction on CSD hold through the creation of a hold instruction. This is necessary if you want to prevent the settlement instruction to be settled. Settlement instructions put on CSD hold are not eligible for settlement until they are released.

Putting a settlement instruction on CSD hold is one option for the creation of a new hold/release instruction for a settlement instruction.

Before you create a new hold instruction for CSD hold, check whether the settlement instruction is eligible for CSD hold. A settlement instruction is eligible to be put on CSD hold if it is not cancelled, settled, already put on CSD hold nor identified as CoSD. You can check the status of your settlement instruction before creating the hold instruction through the details screen as described in the business scenario view settlement instruction details [▶ 742].

This business scenario is not relevant for CB users.

Privileges

To carry out this business scenario, you need the following privileges:

- Settlement instruction query
- Settlement instruction current status query
- Settlement instruction status audit trail query
- CSD hold settlement instruction either on a securities account or on behalf of the CSD in T2S
- Send new instruction using a specific instructing party

Reference

Further information on screens involved can be found in the screen reference part:

- Settlement instructions - search/list* screen
- Settlement instruction - details* screen
- Hold/release instruction - new* screen [▶ 126]

Instructions

1. Go to the *settlement instructions – search/list* screen:
Securities >> Settlement >> Settlement Instructions
2. Enter at least one general search criterion known to you about the settlement instruction you want to put on CSD hold.
3. Click on the *search* button.
 - ⇒ A list containing the search results is displayed on the screen.
 - ⇒ If the search retrieves only one settlement instruction, the *settlement instruction - details* screen is displayed directly. Proceed with step 6.
4. Select the settlement instruction you want to put on CSD hold by clicking on an entry in the list.
5. Click on the *details* button.
 - ⇒ The *settlement instruction – details* screen is displayed.
6. Check the details of the settlement instruction and click on the *hold/release* button.
 - ⇒ The *hold/release instruction – new* screen is displayed.
7. Enter all mandatory information in the ‘General’ subframe.
8. Select the ‘CSD Hold’ check box in the ‘Hold/Release’ subframe.

Current Hold Status	Hold Types	Release Types
Party Hold Status Released	Party Hold <input type="checkbox"/>	Party Release <input type="checkbox"/>
CSD Hold Status Released	CSD Hold <input checked="" type="checkbox"/>	CSD Release <input type="checkbox"/>
CSD Validation Hold Status Released		CSD Validation Release <input type="checkbox"/>
CoSD Hold Status Released		CoSD Release <input type="checkbox"/>
		CoSD Rule Identification <input type="text"/>

**Alternative**

To set all fields to default value and blank out all optional fields, click on the *reset* button.

To cancel the process and return to the previous screen, click on the *cancel* button.

9. Click on the *submit* button.
10. Enter your PIN for digital signature purposes (NRO).
 - ➔ A new hold instruction for CSD hold has been created.

3.5.3.3 Release a Settlement Instruction from Party Hold

Context of Usage

This business scenario describes how to release a settlement instruction from party hold. This is necessary if you want to release a settlement instruction that was previously put on party hold, in order to settle it. Settlement instructions put on party hold are not eligible for settlement until they are released.

Releasing a settlement instruction for party hold is one option for the creation of a new hold/release instruction for a settlement instruction.

Before you create a new release instruction for party hold, check whether the settlement instruction is eligible for the release from party hold. A settlement instruction is eligible to be released for party hold if it is not cancelled, settled nor already released for party hold. You can check the status of your settlement instruction before creating the release instruction through the details screen as described in the business scenario view settlement instruction details [▶ 742].

This business scenario is not relevant for CB users.

Privileges

To carry out this business scenario, you need the following privileges:

- Settlement instruction query
- Settlement instruction current status query
- Settlement instruction status audit trail query
- Release party hold settlement instruction on a securities account or on behalf of an external CSD
- Release party hold auto-collateralisation instruction on a securities account
- Send new instruction using a specific instructing party

Reference

Further information on screens involved can be found in the screen reference part:

- Settlement instructions – search/list* screen
- Settlement instruction – details* screen
- Hold/release instruction - new* screen [▶ 126]

Instructions

1. Go to the *settlement instructions – search/list* screen:
Securities >> Settlement >> Settlement Instructions
2. Enter at least one general search criterion known to you about the settlement instruction you want to release from party hold.
3. Click on the *search* button.
 - ⇒ A list containing the search results is displayed on the screen.
 - ⇒ If the search retrieves only one settlement instruction, the *settlement instruction - details* screen is displayed directly. Proceed with step 6.

4. Select the settlement instruction you want to release for a party hold by clicking on an entry in the list.
5. Click on the *details* button.
 - ⇒ The *settlement instruction – details* screen is displayed.
6. Check the details of the settlement instruction and click on the *hold/release* button.
 - ⇒ The *hold/release instruction – new* screen is displayed.
7. Enter all mandatory information in the ‘General’ subframe.
8. Select the ‘Party Release’ check box in the ‘Hold/Release’ subframe.

Current Hold Status	Hold Types	Release Types
Party Hold Status On Hold	Party Hold <input type="checkbox"/>	Party Release <input checked="" type="checkbox"/>
CSD Hold Status Released	CSD Hold <input type="checkbox"/>	CSD Release <input type="checkbox"/>
CSD Validation Hold Status Released		CSD Validation Release <input type="checkbox"/>
CoSD Hold Status Released		CoSD Release <input type="checkbox"/>
		CoSD Rule Identification * <input type="text"/>



Alternative

To set all fields to default value and blank out all optional fields, click on the *reset* button.

To cancel the process and return to the previous screen, click on the *cancel* button.

9. Click on the *submit* button.
10. Enter your PIN for digital signature purposes (NRO).
 - ➔ A new release instruction for party hold has been created.

3.5.3.4 Partially Release a Settlement Instruction from Party Hold

Context of Usage

This business scenario describes how to partially release a settlement instruction from party hold. This is necessary if you want to partially release a settlement instruction that was previously put on party hold, in order to partially settle it. Settlement instructions put on party hold are not eligible for partial settlement until they are released or partially released.

Before you create a new partial release instruction for party hold, check whether the settlement instruction is eligible for the release from party hold. A business settlement instruction is eligible to be partially released for party hold if it is the delivering leg of the transaction, it is matched, its ISD has been reached, it is not cancelled, settled, already released for party hold and no other hold applies to the transaction. You can check the status of your settlement instruction before creating the partial release instruction through the details screen as described in the business scenario View Settlement Instruction Details [▶ 742].

This business scenario is not relevant for CB users.

Privileges

To carry out this business scenario, you need the following privileges:

- Settlement instruction query
- Settlement instruction current status query
- Settlement instruction status audit trail query
- Release party hold settlement instruction on a securities account or on behalf of an external CSD
- Release party hold auto-collateralisation instruction on a securities account
- Send new instruction using a specific instructing party

Reference

Further information on screens involved can be found in the screen reference part:

- Settlement Instructions - Search/List Screen [▶ 177]
- Settlement Instruction - Details Screen [▶ 192]
- Hold/Release Instruction - New Screen [▶ 126]

Instructions

1. Go to the settlement instructions – search/list screen: Securities >> Settlement >> Settlement Instructions
2. Enter at least one general search criterion known to you about the settlement instruction you want to release from party hold.
3. Click on the search button.
 - ⇒ A list containing the search results is displayed on the screen.
 - ⇒ If the search retrieves only one settlement instruction, the settlement instruction - details screen is displayed directly. Proceed with step 6.
4. Select the settlement instruction you want to release for a party hold by clicking on an entry in the list.
5. Click on the details button.
 - ⇒ The settlement instruction – details screen is displayed.
6. Check the details of the settlement instruction and click on the hold/release button.

⇒ The hold/release instruction – new screen is displayed.

7. Enter all mandatory information in the 'General' subframe.
8. Select the 'Party Release' check box in the 'Hold/Release' subframe.
9. Insert the quantity to be released in the 'Released quantity' field.



Alternative

To set all fields to default value and blank out all optional fields, click on the reset button.

To cancel the process and return to the previous screen, click on the cancel button.

10. Click on the submit button.
 11. Enter your PIN for digital signature purposes (NRO).
- ➔ A new partial release instruction for party hold has been created.

3.5.3.5 Release a Settlement Instruction from CSD Hold

Context of Usage

This business scenario describes how to release a settlement instruction from CSD hold. Settlement instructions put on CSD hold are not eligible for settlement until they are released. This is necessary if you want to release a settlement instruction that was previously put on CSD hold, in order to settle it.

Releasing a settlement instruction for CSD hold is one option for the creation of a new hold/release instruction for a settlement instruction.

Before you create a new release instruction for CSD hold, check whether the settlement instruction is eligible for the release from CSD hold. A settlement instruction is eligible for CSD hold release if it is not cancelled, settled, or already released from CSD hold. You can check the status of your settlement instruction before creating the release instruction through the details screen as described in the business scenario view settlement instruction details [▶ 742].

This business scenario is not relevant for CB users.

Privileges

To carry out this business scenario, you need the following privileges:

- Settlement instruction query
- Settlement instruction current status query
- Settlement instruction status audit trail query
- Release CSD hold settlement instruction either on a securities account or on behalf of the CSD in T2S
- Send new instruction using a specific instructing party

Reference Further information on screens involved can be found in the screen reference part:

- Settlement instructions – search/list* screen
- Settlement instruction – details* screen
- Hold/release instruction - new* screen [▶ 126]

- Instructions**
1. Go to the *settlement instructions – search/list* screen:
Securities >> Settlement >> Settlement Instructions
 2. Enter at least one general search criterion known to you about the settlement instruction you want to release from CSD hold.
 3. Click on the *search* button.
 - ⇒ A list containing the search results is displayed on the screen.
 - ⇒ If the search retrieves only one settlement instruction, the *settlement instruction – details* screen is displayed directly. Proceed with step 6.
 4. Select the settlement instruction you want to release from CSD hold by clicking on an entry in the list.
 5. Click on the *details* button.
 - ⇒ The *settlement instruction – details* screen is displayed.
 6. Check the details of the settlement instruction and click on the *hold/release* button.
 - ⇒ The *hold/release instruction – new* screen is displayed.
 7. Enter all mandatory information in the ‘General’ subframe.
 8. Select the ‘CSD Release’ check box in the ‘Hold/Release’ subframe.

Current Hold Status	Hold Types	Release Types
Party Hold Status Released	Party Hold <input type="checkbox"/>	Party Release <input type="checkbox"/>
CSD Hold Status On Hold	CSD Hold <input type="checkbox"/>	CSD Release <input checked="" type="checkbox"/>
CSD Validation Hold Status Released		CSD Validation Release <input type="checkbox"/>
CoSD Hold Status Released		CoSD Release <input type="checkbox"/>
		CoSD Rule Identification * <input type="text"/>



Alternative

To set all fields to default value and blank out all optional fields, click on the *re-set* button.

To cancel the process and return to the previous screen, click on the *cancel* button.

9. Click on the *submit* button.
10. Enter your PIN for digital signature purposes (NRO).
 - ➔ A new release instruction for CSD hold has been created.

3.5.3.6 Release a Settlement Instruction from CoSD Hold

Context of Usage

This business scenario describes how to release a settlement instruction from CoSD hold. This process is necessary if you want to release a settlement instruction that was previously put on CoSD hold, in order to settle it. Settlement instructions put on CoSD hold are not eligible for settlement until they are released.

Releasing a settlement instruction for CoSD hold is one option for the creation of a new hold/release instruction for a settlement instruction.

Before you create a new release instruction for CoSD hold, check whether the settlement instruction is eligible for the release of CoSD hold. A settlement instruction is eligible to be released from CoSD hold if it is not cancelled, settled, already released for CoSD hold or if the settlement restrictions of the type CoSD blocking related to the CoSD process have not been settled yet. You can check the status of your settlement instruction before creating the release instruction through the details screen as described in the business scenario view settlement instruction details [▶ 742].

This business scenario is not relevant for CB users.

Privileges

To carry out this business scenario, you need the following privileges:

- Settlement instruction query
- Settlement instruction current status query
- Settlement instruction status audit trail query
- Release CoSD rule of settlement instruction on behalf of administering party
- Send new instruction using a specific instructing party

Reference

Further information on screens involved can be found in the screen reference part:

- Settlement instructions – search/list* screen
- Settlement instruction – details* screen
- Hold/release instruction - new* screen [▶ 126]

Instructions

1. Go to the *settlement instructions – search/list* screen:
Securities >> Settlement >> Settlement Instructions
2. Enter at least one general search criterion known to you about the settlement instruction you want to release from CoSD hold.
3. Click on the *search* button.

- ⇒ A list containing the search results is displayed on the screen.
- ⇒ If the search retrieves only one settlement instruction, the *settlement instruction - details* screen is displayed directly. Proceed with step 6.
- 4. Select the settlement instruction you want to release from CoSD hold by clicking on an entry in the list.
- 5. Click on the *details* button.
 - ⇒ The *settlement instruction – details* screen is displayed.
- 6. Check the details of the settlement instruction and click on the *hold/release* button.
 - ⇒ The *hold/release instruction – new* screen is displayed.
- 7. Enter all mandatory information in the ‘General’ subframe.
- 8. Select the ‘CoSD Release’ check box and enter the reference of the relevant CoSD rule to be released in the ‘Hold/Release’ subframe.

The screenshot shows a form titled 'Hold/Release' with three columns: 'Current Hold Status', 'Hold Types', and 'Release Types'. The 'Current Hold Status' column has four rows: 'Party Hold Status Released', 'CSD Hold Status Released', 'CSD Validation Hold Status Released', and 'CoSD Hold Status On Hold'. The 'Hold Types' column has two rows: 'Party Hold' and 'CSD Hold', each with a checkbox. The 'Release Types' column has four rows: 'Party Release', 'CSD Release', 'CSD Validation Release', and 'CoSD Release', each with a checkbox. The 'CoSD Release' checkbox is highlighted with a red box, and below it is a text input field labeled 'CoSD Rule Identification'.



Alternative

To set all fields to default value and blank out all optional fields, click on the *reset* button.

To cancel the process and return to the previous screen, click on the *cancel* button.

- 9. Click on the *submit* button.
- 10. Enter your PIN for digital signature purposes (NRO).
 - ➔ A new release instruction for CoSD hold has been created.

3.5.3.7 Release a Settlement Instruction from CSD Validation Hold

Context of Usage

This business scenario describes how to release a settlement instruction from CSD validation hold. This is necessary if you want to release a settlement instruction that was previously put on CSD validation hold in order to settle it. Settlement instructions put on CSD validation hold are not eligible for settlement until they are released.

Releasing a settlement instruction for CSD validation hold is one option for the creation of a new hold/release instruction for a settlement instruction.

Before you create a new release instruction for CSD validation hold, check whether the settlement instruction is eligible for the release from CSD validation hold. A settlement instruction is eligible to be released for a CSD validation hold if it is not cancelled, settled nor already released for CSD validation hold. You can check the status of your settlement instruction before creating the release instruction through the details screen as described in the business scenario view settlement instruction details [▶ 742].

This business scenario is not relevant for CB users.

Privileges

To carry out this business scenario, you need the following privileges:

- Settlement instruction query
- Settlement instruction current status query
- Settlement instruction status audit trail query
- Release CSD validation hold settlement instruction either on a securities account or on behalf of the CSD in T2S
- Send new instruction using a specific instructing party

Reference

Further information on screens involved can be found in the screen reference part:

- Settlement instructions – search/list* screen
- Settlement instruction – details* screen
- Hold/release instruction - new* screen [▶ 126]

Instructions

1. Go to the *settlement instructions – search/list* screen:
Securities >> Settlement >> Settlement Instructions
2. Enter at least one general search criterion known to you about the settlement instruction you want to release from CSD validation hold.
3. Click on the *search* button.
 - ⇒ A list containing the search results is displayed on the screen.
 - ⇒ If the search retrieves only one settlement instruction, the *settlement instruction - details* screen is displayed directly. Proceed with step 6.

4. Select the settlement instruction you want to release CSD validation hold by clicking on an entry in the list.
5. Click on the *details* button.
 - ⇒ The *settlement instruction – details* screen is displayed.
6. Check the details of the settlement instruction and click on the *hold/release* button.
 - ⇒ The *hold/release instruction – new* screen is displayed.
7. Enter all mandatory information in the 'General' subframe.
8. Select the 'CSD Validation Release' check box in the 'Hold/Release' sub-frame.

The screenshot displays a form titled 'Hold/Release' with three main sections: 'Current Hold Status', 'Hold Types', and 'Release Types'. Each section contains several items with checkboxes. The 'CSD Validation Release' checkbox in the 'Release Types' section is highlighted with a red box.

Current Hold Status	Hold Types	Release Types
Party Hold Status Released <input type="checkbox"/>	Party Hold <input type="checkbox"/>	Party Release <input type="checkbox"/>
CSD Hold Status Released <input type="checkbox"/>	CSD Hold <input type="checkbox"/>	CSD Release <input type="checkbox"/>
CSD Validation Hold Status On Hold <input type="checkbox"/>		CSD Validation Release <input type="checkbox"/>
CoSD Hold Status Released <input type="checkbox"/>		CoSD Release <input type="checkbox"/>
		CoSD Rule Identification <input type="text"/>



Alternative

To set all fields to default value and blank out all optional fields, click on the *reset* button.

To cancel the process and return to the previous screen, click on the *cancel* button.

9. Click on the *submit* button.
10. Enter your PIN for digital signature purposes (NRO).
 - ➔ A new release instruction for CSD validation hold has been created.

3.5.3.8 View Hold/Release Instruction Details

Context of Usage

This business scenario describes how to view the details of a hold/release instruction. Once the hold/release instruction is created in T2S it might be necessary for you to check its details to be aware of updates during the lifecycle of the hold/release instruction.

Viewing a hold/release instruction details is one option for the creation of a new hold/release instruction for a settlement instruction.

This business scenario is not relevant for CB users.

Privileges

To carry out this business scenario, you need the following privileges:

- Amendment instruction query for intra-position movements and settlement instructions
- Hold/release instruction audit trail list query
- Maintenance for intra-position movements and settlement instructions query
- Cancellation instruction query for intra-position movements and settlement instructions

Reference

Further information on screens involved can be found in the screen reference part:

- Maintenance securities instructions – search/list* screen [▶ 164]
- Hold/release instruction – details* screen [▶ 122]

Instructions

1. Go to *maintenance securities instructions – search/list* screen:
Securities >> Settlement >> Maintenance Securities Instructions
2. Enter all search criteria known to you about the hold/release instruction for which you want to view the details.
3. Select the value 'Settlement Instruction' in the 'Instruction Type' field.

The screenshot shows the 'Search Criteria - Maintenance Securities Instructions' form. The 'Instruction Type' dropdown menu is highlighted with a red box, and 'Settlement Instruction' is selected. Other fields include Actor Reference, T2S Reference, Instructing Party BIC, Securities Account Number, Maintenance Instruction Type (set to 'Hold/Release Instruction'), Execution Status (set to 'All'), Entry Date, Cancellation Status (set to 'All'), and Pending Cancellation (set to 'All').

4. Select the value 'Hold/Release Instruction' in the 'Maintenance Instruction Type' field.

The screenshot shows the 'Search Criteria - Maintenance Securities Instructions' form. The 'Maintenance Instruction Type' dropdown menu is highlighted with a red box, and 'Hold/Release Instruction' is selected. The 'Instruction Type' dropdown is now set to 'Settlement Instruction'. Other fields are the same as in the previous screenshot.



Alternatives

To set all fields to default value and blank out all optional fields, click on the *reset* button.

5. Click on the *search* button.
 - ⇒ A list containing the search results is displayed on the screen.
 - ⇒ If the search retrieves only one hold/release instruction, the *hold/release instruction – details* screen is displayed directly.
6. Select the hold/release instruction for which you want to view the details.
7. Click on the *details* button.
 - ⇒ The *hold/release instruction – details* screen is displayed.
- ➔ You have viewed the details of a hold/release instruction.

3.5.4 Creation of a New Cancellation Instruction for a Settlement Instruction

Overview

This business package describes the creation of a new cancellation instruction for a settlement instruction.

You can create a new cancellation instruction for a settlement instruction and afterwards you can check the information of the cancellation instruction in T2S.

To create a new cancellation instruction for a settlement instruction, carry out the following business scenarios in the predefined order.

Business Scenarios

1. Cancel a settlement instruction [▶ 768]
2. View cancellation instruction for a settlement instruction details [▶ 770]
3. View alleged cancellation instructions [▶ 771]

3.5.4.1 Cancel a Settlement Instruction

Context of Usage

This business scenario describes how to create a new cancellation instruction for a settlement instruction. This is necessary if you want to cancel a settlement instruction so it is not further processed in T2S.

Cancelling a settlement instruction is mandatory for the creation of a cancellation instruction for a settlement instruction.

Before you cancel a settlement instruction, check whether the settlement instruction is neither already cancelled, settled nor on CoSD hold. You can check the status of your settlement instruction before creating the cancellation instruction through the details screen as described in the business scenario view settlement instruction details [▶ 742].

This business scenario is not relevant for CB users.

Privileges

To carry out this business scenario, you need the following privileges:

- Settlement instruction query
- Settlement instruction current status query

- Settlement instruction status audit trail query
- Cancel settlement instruction / settlement restriction on securities either on a securities account or on behalf of the CSD in T2S, on behalf of an external CSD or on behalf of an administering party
- Cancel non-modifiable instructions on behalf of the instructing party of the underlying settlement instruction
- Send new instruction using a specific instructing party

Reference

Further information on screens involved can be found in the screen reference part:

- Settlement instructions – search/list* screen
- Settlement instruction - details* screen
- Cancellation securities instruction - new* screen [▶ 117]

Instructions

1. Go to the *settlement instructions – search/list* screen:
Securities >> Settlement >> Settlement Instructions
2. Enter at least one general search criterion known to you about the settlement instruction for which you want to view the details.
3. Click on the *search* button.
 - ⇒ A list containing the search results is displayed on the *settlement instructions – search/list* screen.
 - ⇒ If the search retrieves a single settlement instruction, the *settlement instruction - details* screen is displayed directly. Proceed with step 6.
4. Select the settlement instruction you want to cancel by clicking on an entry in the list.
5. Click on the *details* button.
 - ⇒ The *settlement instruction - details* screen is displayed.
6. Click on the *cancellation instruction* button.
 - ⇒ The *cancellation securities instruction - new* screen is displayed.
7. Enter all relevant information in the 'General' frame if needed.

**Alternative**

To set all fields to default value and blank out all optional fields, click on the *reset* button.

To cancel the process and return to the previous screen, click on the *cancel* button.

8. Click on the *submit* button.
9. Enter your PIN for digital signature purposes (NRO).

➔ A new cancellation instruction for a settlement instruction has been created.

3.5.4.2 View Cancellation Instruction for a Settlement Instruction Details

Context of Usage

This business scenario describes how to view the details of a cancellation instruction for a settlement instruction. Once the amendment instruction for a settlement instruction is created in T2S it might be necessary for you to check its details to be aware of updates during the lifecycle of the cancellation instruction. Viewing a cancellation instruction for a settlement instruction details is optional for the creation of a new cancellation instruction for a settlement instruction.

This business scenario is not relevant for CB users.

Privileges

To carry out this business scenario, you need the following privileges:

- Amendment instruction query for intra-position movements and settlement instructions
- Maintenance for intra-position movements and settlement instructions query
- Cancellation instruction query for intra-position movements and settlement instructions
- Cancellation instruction for intra-position movement or settlement instruction audit trail details query

Reference

Further information on screens involved can be found in the screen reference part:

- Maintenance securities instructions – search/list* screen [▶ 164]
- Cancellation securities instruction - details* screen [▶ 113]

Instructions

1. Go to the *maintenance securities instructions – search/list* screen:
Securities >> Settlement >> Maintenance Securities Instructions
2. Enter all search criteria known to you about the cancellation instruction for a settlement instruction for which you want to view the details.
3. Select the value 'Settlement Instruction' in the 'Instruction Type' field.

4. Select the value 'Cancellation Instruction' in the 'Maintenance Instruction Type' field.

The screenshot shows a search criteria form for 'Maintenance Securities Instructions'. The form includes several input fields and dropdown menus. The 'Maintenance Instruction Type' dropdown menu is highlighted with a red box, and 'Cancellation Instruction' is selected. Other fields include 'Actor Reference', 'T2S Reference', 'Instruction Type*' (Settlement Instruction), 'Instructing Party Parent BIC', 'Instructing Party BIC', 'Securities Account Number', 'Entry Date', 'Execution Date', 'Cancellation Status' (All), and 'Pending Cancellation' (All).



Alternative

To set all fields to default value and blank out all optional fields, click on the *reset* button.

5. Click on the *search* button.
 - ⇒ A list containing the search results is displayed on the screen.
 - ⇒ If the search retrieves only one cancellation instruction for a settlement instruction, the *cancellation securities instruction - details* screen is displayed directly.
6. Select the cancellation instruction for a settlement instruction for which you want to view the details.
7. Click on the *details* button.
 - ⇒ The *cancellation securities instruction - details* screen is displayed.
- ➔ You have viewed the details of a cancellation instruction for a settlement instruction.

3.5.4.3 View Alleged Cancellation Instructions

Context of Usage

This business scenario describes how to check if there is any settlement instruction requested for cancellation by the counterparty of the transaction in T2S. Once a settlement instruction is created in T2S it might be necessary for you to check if it has been requested for cancellation by the counterparty to create your own cancellation instruction in order to cancel the transaction in T2S. Once a settlement instruction is matched in T2S with its counterpart, bilateral cancellation by the two legs of the transaction is required.

Viewing alleged cancellation instructions is one option for the creation of a new cancellation instruction for a settlement instruction.

This business scenario is not relevant for CB users.

Privileges

To carry out this business scenario, you need the following privileges:

- Settlement instruction query

- Settlement instruction current status query
- Settlement instruction status audit trail query

Reference

Further information on screens involved can be found in the screen reference part:

- Settlement instructions– search/list* screen
- Settlement instruction - details* screen

Instructions

1. Go to the *settlement instructions– search/list* screen:
Securities >> Settlement >> Settlement Instructions
2. Enter at least one general search criterion known to you about the settlement instruction for which you want to check if it has been requested for cancellation.
3. Click on the *search* button.
 - ⇒ The *settlement instructions – search/list* screen is displayed.
 - ⇒ If the search retrieves only one settlement instruction, the *settlement instruction - details* screen is displayed directly. Proceed with step 6.
4. Select the settlement instruction you want to check if it has been requested for cancellation by its counterpart by clicking on an entry in the list.

**Alternative**

To set all fields to default value and blank out all optional fields, click on the *reset* button.

To cancel the process and return to the previous screen, click on the *cancel* button.

5. Click on the *details* button.
 - ⇒ The *settlement instruction - details* screen is displayed.
6. Check if the 'Cancellation Requested' field in the 'Status Information' frame has the value 'Yes'. If the value is 'Yes', the settlement instruction has been requested for cancellation by the counterparty. In order to execute the cancellation another cancellation instruction needs to be received in T2S for this leg.

**Hint**

If you want to send a cancellation instruction to complete the cancellation request, continue with step 6 of the 'Cancel a Settlement Instruction [▶ 768]' business scenario.

- ➔ You have viewed your alleged cancellation instructions.

3.5.5 Monitoring of the Lifecycle of a Settlement Instruction

Overview

This business package describes the monitoring of the lifecycle of a settlement instruction.

You can check the status updates during the lifecycle of a settlement instruction once it has been created in T2S.

To monitor the lifecycle of a settlement instruction, carry out the following business scenarios.

Business Scenarios

- View settlement instruction status history [▶ 773]
- View SF1/SF2 timestamps of Settlement Instructions in case of Insolvency situation [▶ 774]

3.5.5.1 View Settlement Instruction Status History

Context of Usage

This business scenario describes how to view the status history of a settlement instruction.

Once a settlement instruction is created in T2S it might be necessary for you to check its status history to be aware of its status changes during the lifecycle of the settlement instruction.

Viewing settlement instruction status history is mandatory for the monitoring of the lifecycle of a settlement instruction

This business scenario is not relevant for CB users.

Privileges

To carry out this business scenario, you need the following privileges:

- Settlement instruction query
- Settlement instruction current status query
- Settlement instruction status audit trail query
- Settlement instruction audit trail query

Reference

Further information on screens involved can be found in the screen reference part:

- Settlement instructions – search/list* screen
- Settlement instruction – details* screen
- Status history – details* screen [▶ 267]

Instructions

1. Go to the *settlement instructions – search/list* screen:
`Securities >> Settlement >> Settlement Instructions`
2. Enter at least one general search criterion known to you about the settlement instruction for which you want to view the details.
3. Click on the *search* button.

- ⇒ A list containing the search results is displayed on the screen.
- ⇒ If the search retrieves only one settlement instruction, the *settlement instruction – details* screen is displayed directly. Proceed with step 6.



Alternative

To set all fields to default value and blank out all optional fields, click on the *reset* button.

4. Select the settlement instruction for which you want to view the details.
 5. Click on the *details* button.
 - ⇒ The *settlement instruction – details* screen is displayed.
 6. Click on the *status history* button.
 - ⇒ The *status history - details* screen is displayed.
- ➔ You have viewed the settlement instruction status history.

3.5.5.2 View SF1/SF2 timestamps of Settlement Instructions in case of Insolvency situation

Context of Usage

This business scenario describes how to retrieve the SF1/SF2 timestamps of settlement instructions in case of insolvency situation.

Once a settlement instruction is created in T2S it might be necessary for you to retrieve the SF1/SF2 timestamps for insolvency proceedings during the lifecycle of the settlement instruction.

This business scenario is not relevant for CB users.

Privileges

To carry out this business scenario, you need the following privilege:

- Settlement instruction matched and accepted status query privilege

Reference

Further information on screens involved can be found in the screen reference part:

- Insolvency procedure settlement instructions – search/list* screen [▶ 270]

Instructions

1. Go to the *insolvency procedure settlement instructions – search/list* screen:
Securities >> Settlement >> Insolvency procedure Settlement Instructions
2. Enter at least one insolvent object criterion known to you to retrieve SF1 and SF2 timestamps of settlement instructions under insolvency procedures.
3. Click on the *search* button.
 - ⇒ A list containing the search results is displayed on the screen.

- ➔ You have retrieved SF1/SF2 timestamps of Settlement Instructions in case of Insolvency situation



Alternative

To set all fields to default value and blank out all optional fields, click on the *re-set* button.

3.5.6 View the list of links data preventing settlement of a settlement instruction

Context of Usage

This business scenario describes how to view the list of data preventing settlement of a selected settlement instruction.

When a linked settlement instruction is unsettled, it might be useful for you to check the list of the settlement instructions or settlement restrictions preventing its settlement with the associated constraints.

This business scenario is not relevant for the following cases:

- Settled, cancelled and not matched instructions
- Settlement instructions with an intended settlement date in the future

Privileges

To carry out this business scenario, you need the following privileges:

- Settlement instruction query
- Settlement instruction current status query

Reference

Further information on screens involved can be found in the screen reference part:

- Settlement instructions – search/list
- Settlement instruction – details
- Links preventing settlement – list

Instructions

1. Go to the settlement instructions – search/list screen:
Securities >> Settlement >> Settlement Instructions
2. Enter at least one general search criterion known to you about the settlement instruction for which you want to view the links data preventing its settlement.
3. Click on the search button.
 - A list containing the search results is displayed on the screen
 - If the search retrieves only one settlement instruction, the settlement instruction – details screen is displayed directly. Proceed with step 6.

4. Select the settlement instruction for which you want to view the links data preventing settlement by clicking on an entry in the list.
5. Click on the details button.
 - The settlement instructions – details screen is displayed.
6. Check the details of the settlement instruction and click on the links button.
 - The links preventing settlement – list screen is displayed.
 - You have viewed the list of the settlement instructions and/or settlement instructions preventing the settlement of the selected settlement instruction with the associated constraints.

3.5.7 Monitoring of Penalties

Overview

This business package describes the monitoring of the penalties computed by T2S for failing settlement instructions.

You can search for penalties computed by T2S, view the individual details of a penalty, modify existing penalties, view the list of penalties related to a settlement instruction and check the monthly net amounts of the penalties computed for the business days of a previous month.

To monitor penalties, the following business scenarios are available.

Business Scenarios

- View the individual penalty details
- Modification of existing penalties
- View list of penalties
- View the monthly net amount of penalties

3.5.7.1 View the Individual Penalty Details

Context of Usage

This business scenario describes how to retrieve the details of a penalty associated to a settlement instruction.

Once a penalty is computed for a given settlement instruction it might be necessary for you to retrieve its details.

This function will not be available either during the Maintenance Window or during the processing of penalties, i.e. between the Events “PMSS” (Penalty Mechanism- Stop Screens and penalty modification requests) and “PMRR” (Penalty Mechanism- Restart GUI and Restart processing penalty modification requests).

This business scenario is only available for CSD authorized users and T2S Operator user.

Privileges

To carry out this business scenario, you need the following privileges:

- Penalty Details Query Privilege

- Settlement Instruction Audit Trail Query

Reference

Further information on screens involved can be found in the screen reference part:

- Penalty – search/list screen
- Penalty – details screen
- Settlement instruction – details screen

Instructions

1. Go to the Penalty – search/list screen:
Securities >> Settlement >> Daily Penalties
2. Enter a valid combination of search criteria. For this, you can either choose:
 - ⇒ To perform the query with a reference. For this you should specify at least one or a valid combination of the search criteria.
This query cannot use the Additional Search Criteria for Penalty Query by ISIN Code Criteria, by T2S Party Criteria and System Entity Criteria.
This query cannot be combined with any other query.
 - ⇒ To perform the query by ISIN Code Criteria and/or by T2S Party Criteria.
These two queries can be combined or used separately.
If combined together, the parameters will be combined through AND logic, and the minimum search criteria of at least one of the two queries shall be respected.
At least the minimum search criteria shall be specified. Additional search criteria can be used to limit the query results.
 - ⇒ To perform a System Entity Criteria query. For this you should at least enter the minimum search criteria.
Additional search criteria can be used to limit the query results.
This query cannot be combined with any other query.
3. Click on the search button.
 - ⇒ If the search retrieves more than one penalty a list containing the search results is displayed on the screen.
 - ⇒ If the search retrieves only one penalty, the penalty – details screen is displayed directly.
 - ⇒ You have viewed the individual penalty details.



Alternative

4. Select the penalty for which you want to view the details by clicking on the entry in the list.
5. Click on the details button.

- ⇒ The penalty – details screen is displayed.
- ⇒ You have viewed the individual penalty details.



Alternative

6. In the Settlement Instruction – details screen >> Click on the associated penalties button.
 - ⇒ If more than one penalty is retrieved by T2S, the penalty – search/list screen will be displayed.
 - ⇒ If only one penalty is retrieved by T2S, the penalty – details screen will be displayed.
- ➔ You have viewed the individual penalty details



Alternative

To set all fields to default value and blank out all optional fields, click on the reset button

3.5.7.2 Modification of existing penalties

Context of Usage

This business scenario describes how to remove, re-include, re-allocate or switch an existing penalty computed for a settlement instruction.

CSDs and T2S Operator will be able to request the removal of a penalty only when the penalty was imposed to one of its participants or to itself. To cater for mistakes in the removal of penalties, T2S allows CSDs and T2S Operator to re-include a penalty that the CSD has previously removed.

Also, when an already matched settlement instruction is sent late to T2S, CSDs and T2S Operator are able to re-allocate the penalty from the Instructing Party, initially assigned as failing and non-failing party, to the delivering party and the receiving party of the instruction. Finally, if T2S calculates and assigns the penalty to a party which, due to external conditions outside T2S, should not be the party penalised but entitled to receive the penalty, CSDs and T2S Operator will be able to switch the failing and non-failing party of the penalty.

You may remove, re-include, re-allocate or switch existing penalties anytime of the day except during the Maintenance Window or during the processing of penalties, i.e. between the Events “PMSS” (Penalty Mechanism- Stop Screens and penalty modification requests) and “PMRR” (Penalty Mechanism- Restart GUI and Restart processing penalty modification requests).

These functionalities are only available during the appeal period of the penalty.

Additionally:

- If the status of the penalty is not 'Active', the remove function will not be available.
- If the status of the penalty is not 'Removed', the re-include function will not be available.
- If either the status of the penalty is not 'Active', or the penalty is a SEFP, or if it is a LMFP but the underlying instruction was not sent as already matched to T2S, or the LMFP has already been re-allocated before, the re-allocate function will not be available.
- If the status of the penalty is not 'Active', the switch function will not be available.
- This business scenario is only available for CSD authorized users and T2S Operator user.

Privileges

To carry out this business scenario, you need the following privileges:

- Penalty Details Query Privilege
- Settlement Instruction Audit Trail Query
- Modification of Penalties Privilege

References

Further information on screens involved can be found in the screen reference part:

- Penalty – details screen
- Penalty removal screen
- Penalty re-inclusion screen
- Penalty re-allocacion screen
- Penalty switch screen

Instructions

1. Go to the Penalty – search/list screen:
Securities >> Settlement >> Daily Penalties
2. Enter a valid combination of search criteria. For this, you can either choose:
 - ⇒ To perform the query with a reference. For this you should specify at least one or a valid combination of the search criteria.
This query cannot use the Additional Search Criteria for Penalty Query by ISIN Code Criteria, by T2S Party Criteria and System Entity Criteria.
This query cannot be combined with any other query.
 - ⇒ To perform the query by ISIN Code Criteria and/or by T2S Party Criteria.
These two queries can be combined or used separately.
If combined together, the parameters will be combined through AND logic, and the minimum search criteria of at least one of the two queries shall be

respected.

At least the minimum search criteria shall be specified. Additional search criteria can be used to limit the query results.

- ⇒ To perform a System Entity Criteria query. For this you should at least enter the minimum search criteria.

Additional search criteria can be used to limit the query results.

This query cannot be combined with any other query.

3. Click on the search button.

- ⇒ If the search retrieves more than one penalty a list containing the search results is displayed on the screen.
- ⇒ If the search retrieves only one penalty, the penalty – details screen is displayed directly.



Alternative

4. Select the penalty for which you want to view the details by clicking on the entry in the list.

5. Click on the details button.

- ⇒ The penalty – details screen is displayed.

6. To remove a penalty:

- ⇒ Click on the “Remove” button. This function will not be available if the status of the penalty is not ‘Active’.
- ⇒ Penalty removal screen will pop up with the relevant information to create a Removal Request based on the Penalty of the screen.
- ⇒ Select the reason code, insert the Description text if the reason selected is OTHR, and click on the Submit button.
- ⇒ Enter your PIN for digital signature purposes (NRO).

➔ You have removed the penalty.

7. To re-include a penalty:

- ⇒ Click on the “Re-include” button. This function will not be available if the status of the penalty is not ‘Removed’.
- ⇒ A confirmation prompt will pop-up. Hence, the action is triggered (i.e. the Re-inclusion Request is sent) and the Penalty - details screen is displayed again updated (i.e. Penalty with new status ACTV, (Active), new Reason Code UPDT (Updated) and description (if applies), the penalty amount

and Calculation details before the penalty was removed and the To be re-calculated flag set to YES) if the Re-inclusion Request is confirmed and executed (the action was triggered in Two-eyes).

- ⇒ Click on the Yes button.
 - ⇒ Enter your PIN for digital signature purposes (NRO).
 - ➔ You have re-included the penalty.
8. To re-allocate a penalty:
- ⇒ Click on the “Re-allocate” button. This function will not be available if either the status of the penalty is not ‘Active’, if the penalty is a SEFP or a LMFP but the underlying instruction was not sent as already matched to T2S, or if the LMFP has already been re-allocated before.
 - ⇒ Penalty re-allocation screen will pop-up with the relevant information to create a Re-allocation Request based on the Penalty of the screen.
 - ⇒ Select the New failing party and, only in case the two BIC’s retrieved for the New failing Party BIC are the same, additionally select the T2S Reference of the Failing Settlement Instruction. Finally, click on the Submit button.
 - ⇒ Enter your PIN for digital signature purposes (NRO).
- ➔ You have re-allocated the penalty
9. To switch a penalty:
- ⇒ Click on the “Switch” button. This function will not be available if the status of the penalty is not ‘Active’.
 - ⇒ Penalty switch screen will pop-up with the relevant information to create a Switch Request based on the Penalty of the screen.
 - ⇒ Insert the Description text and click on the Submit button.
 - ⇒ Enter your PIN for digital signature purposes (NRO).
- ➔ You have switched the penalty.



Alternative

10. In the Settlement Instruction – details screen >> Click on the associated penalties button.
- ⇒ If more than one penalty is retrieved by T2S, the penalty – search/list screen will be displayed.
 - ⇒ If only one penalty is retrieved by T2S, the penalty – details screen will be displayed.
2. To remove a penalty:

- ⇒ Click on the “Remove” button. This function will not be available if the status of the penalty is not ‘Active’.
 - ⇒ Penalty removal screen will pop up with the relevant information to create a Removal Request based on the Penalty of the screen.
 - ⇒ Select the reason code, insert the Description text if reason selected is OTHR, and click on the Submit button.
 - ⇒ Enter your PIN for digital signature purposes (NRO).
 - ➔ You have removed the penalty.
12. To re-include a penalty:
- ⇒ Click on the “Re-include” button. This function will not be available if the status of the penalty is not ‘Removed’.
 - ⇒ A confirmation prompt will pop-up. Hence, the action is triggered (i.e. the Re-inclusion Request is sent) and the Penalty - details screen is displayed again updated (i.e. Penalty with new status ACTV, (Active), new Reason Code UPDT (Updated) and description (if applies), the penalty amount and Calculation details before the penalty was removed and the flag To be recalculated set to YES) if the Re-inclusion Request is confirmed and executed (the action was triggered in Two-eyes).
 - ⇒ Click on the Yes button.
 - ⇒ Enter your PIN for digital signature purposes (NRO).
 - ➔ You have re-included the penalty.
13. To re-allocate a penalty:
- ⇒ Click on the “Re-allocate” button. This function will not be available if either the status of the penalty is not ‘Active’, if the penalty is a SEFP or a LMFP but the underlying instruction was not sent as already matched to T2S, or if the LMFP has been re-allocated before.
 - ⇒ Penalty re-allocation screen will pop-up with the relevant information to create a Re-allocation Request based on the Penalty of the screen.
 - ⇒ Select the New failing party and only in case the two BIC’s retrieved for the New failing Party BIC are the same, additionally select the T2S Reference of Failing Settlement Instruction. Finally, click on the Submit button.
 - ⇒ Enter your PIN for digital signature purposes (NRO).
 - ➔ You have re-allocated the penalty.
14. To switch a penalty:
- ⇒ Click on the “Switch” button. This function will not be available if the status of the penalty is not ‘Active’.
 - ⇒ Penalty switch screen will pop-up with the relevant information to create a Switch Request based on the Penalty of the screen.

- ⇒ Insert the Description text and click on the Submit button.
- ⇒ Enter your PIN for digital signature purposes (NRO).
- ➔ You have switched the penalty.

3.5.7.3 View List of Penalties

Context of Usage

This business scenario describes how to retrieve the list of penalties associated to a settlement instruction.

Once a given settlement instruction is subject to the calculation of penalties it might be necessary for you to retrieve them.

This function will not be available either during the Maintenance Window or during the processing of penalties, i.e. between the Events “PMSS” (Penalty Mechanism- Stop Screens and penalty modification requests) and “PMRR” (Penalty Mechanism- Restart GUI and Restart processing penalty modification requests).

This business scenario is only available for CSD authorized users and T2S Operator user.

Privileges

To carry out this business scenario, you need the following privileges:

- Penalty List Query Privilege
- Settlement Instruction Audit Trail Query

Reference

Further information on screens involved can be found in the screen reference part:

- Penalty – search/list screen
- Settlement instruction – details screen

Instructions

1. Go to the Penalty – search/list screen:
Securities >> Settlement >> Daily Penalties
2. Enter a valid combination of search criteria. For this, you can either choose:
 - ⇒ To perform the query with a reference. For this you should specify at least one or a valid combination of the search criteria.
This query cannot use the Additional Search Criteria for Penalty Query by ISIN Code Criteria, by T2S Party Criteria and System Entity Criteria.
This query cannot be combined with any other query.
 - ⇒ To perform the query by ISIN Code Criteria and/or by T2S Party Criteria.
These two queries can be combined or used separately.
If combined together, the parameters will be combined through AND logic, and the minimum search criteria of at least one of the two queries shall be respected.
At least the minimum search criteria shall be specified. Additional search criteria can be used to limit the query results.

- ⇒ To perform a System Entity Criteria query. For this you should at least enter the minimum search criteria.
Additional search criteria can be used to limit the query results.
This query cannot be combined with any other query.
- 3. Click on the search button.
 - ⇒ If the search retrieves more than one penalty a list containing the search results is displayed on the screen.
 - ⇒ You have viewed the list of penalties.
 - ⇒ If the search retrieves only one penalty, the penalty – details screen is displayed directly.



Alternative

- 4. In the Settlement Instruction – details screen >> Click on the associated penalties button.
 - ⇒ If more than one penalty is retrieved by T2S, the penalty – search/list screen will be displayed.
 - ⇒ You have viewed the list of penalties.
 - ⇒ If only one penalty is retrieved by T2S, the penalty – details screen will be displayed.



Alternative

To set all fields to default value and blank out all optional fields, click on the reset button.

3.5.7.4 View monthly aggregated net amounts of penalties

Context of Usage

This business scenario describes how to retrieve the monthly aggregated net amounts of the penalties computed by T2S for the business days of a previous month, for a given T2S Party and counterparty(ies) and per relevant currency.

Once the appeal period of the penalties of a given month has ended, you may need to retrieve the monthly net amounts for all the penalties computed by T2S to ease the penalty collection and distribution process.

This amount shall provide, per currency and party, the bilateral net amounts against each of the counterparties of the penalties computed, and will be equal to:

- The sum of all penalties of the relevant/previous month in the relevant currency that this party is entitled to receive (reported as credit) from the same counterparty (i.e. to be paid by this counterparty);

Minus

- The sum of all penalties of the relevant/previous month in the relevant currency, that were imposed to this party (reported as debit), and to be paid to a given counterparty.

The monthly net amounts of a particular month will be available only once T2S has produced the Monthly Aggregated Amounts report of that month.

Only the monthly net amounts for the past 3 months will be available.

This function will not be available during the Maintenance Window.

This business scenario is only available for CSD authorized users and T2S Operator user.

Privileges

To carry out this business scenario, you need the following privileges:

- Penalty Details Query Privilege
- Monthly Net Amount Query Privilege

Reference

Further information on screens involved can be found in the screen reference part:

- Monthly Net Penalty Amounts – search/list screen

Instructions

1. Go to the Penalty – search/list screen:
Securities >> Settlement >> Monthly Penalties
 2. Enter at least the minimum search criteria.
Depending on the search criteria specified, one or more results can be displayed (i.e. depending on the currency or on the counterparty).
 3. Click on the search button.
 - ⇒ If the search retrieves more than one monthly net amount, a list containing the search results is displayed on the screen.
 - ⇒ If the search retrieves only one monthly net amount, it will be displayed in the same format used by the list screen.
- ➔ You have viewed the monthly net amount.

3.6 Settlement Restrictions

3.6.1 Creation of a New Settlement Restriction on Securities

Overview

This business package describes the creation of a new settlement restriction on securities.

You can create a new settlement restriction on securities either by entering all the necessary information or by copying it from an already existing settlement restriction on securities. Once the settlement restriction on securities has been created, you can also check its lifecycle in T2S.

To create a new settlement restriction on securities, carry out the following business scenarios in the predefined order and choose the business scenario relevant to you whenever options are given.

Business Scenarios

1. Create a new settlement restriction on securities
 - Enter a settlement restriction on securities [▶ 786]
 - Copy a settlement restriction on securities [▶ 788]
2. View settlement restriction on securities details [▶ 791]

3.6.1.1 Enter a Settlement Restriction on Securities

Context of Usage

This business scenario describes how to create a new settlement restriction on securities. You can create a new settlement restriction on securities (intra-position movement) to move securities into a specific securities position of a securities account and make them available for a specific purpose (blocking, reservation or earmarking). Optionally, you can create your settlement restriction on securities including a link to another instruction or to a pool of instructions.

Entering a settlement restriction on securities is one option for the creation of a settlement restriction on securities.

This business scenario is not relevant for CB users.

Privileges

To carry out this business scenario, you need the following privileges:

- Send new settlement instruction/new settlement restriction on securities either on a securities account or on behalf of an external CSD
- Unblock CoSD securities blocking related to cancelled CoSD settlement instructions on behalf of the relevant CSD in T2S
- Link to an instruction/pool reference belonging to a specific party
- Intra-position movements query
- Send new instruction using a specific instructing party

Reference Further information on screens involved can be found in the screen reference part:

- *Intra-position movements– search/list* screen [▶ 137]
- *Intra-position movement – new* screen [▶ 151]

Instructions

1. Go to the *intra-position movements– search/list* screen:
Securities >> Settlement >> Intra-Position Movements
2. Click on the *new* button.
⇒ The *intra-position movement - new* screen is displayed.
3. Enter all mandatory information about the settlement restriction you want to create in the 'Intra-Position Movement' frame.
4. Optionally, you can enter additional information about the settlement restriction on securities into the optional fields.
5. To link your settlement restriction on securities to another instruction, click on the *add row* icon to add a new link

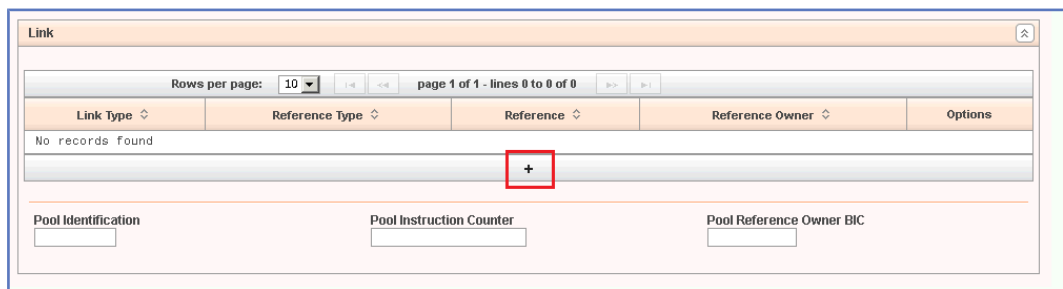

6. Select and add all the requested information to identify the instruction you want your settlement restriction on securities to be linked with. Once all the information is introduced click on the *submit changes* icon in the 'Options' column.

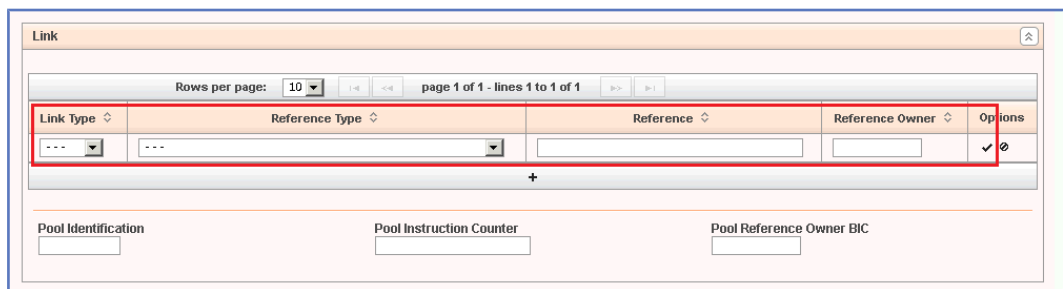

⇒ The link has been added to the list.

7. If you want to add your settlement restriction on securities to a pool, enter the 'Pool Identification' field, 'Pool Instruction Counter' field and the 'Pool Reference Owner BIC' field instead.

Link Type	Reference Type	Reference	Reference Owner	Options
No records found				
+				
Pool Identification	Pool Instruction Counter	Pool Reference Owner BIC		



Repetition

To add more links, repeat steps 5 to 6.

- To remove a link from the list of links to be added to the settlement restriction on securities, click on the *Delete Row* icon in the 'Options' column.

⇒ The link has been deleted from the list of links



Alternatives

To set all fields to default value and blank out all optional fields, click on the *reset* button.

To cancel the process and return to the previous screen, click on the *cancel* button.

- Click on the *submit* button.
 - Enter your PIN for digital signature purposes (NRO).
- ➔ The new settlement restriction on securities has been created.

3.6.1.2 Copy a Settlement Restriction on Securities

Context of Usage

This business scenario describes how to create a new settlement restriction on securities. You can create a new settlement restriction on securities (intra-position movement) to move securities into a specific securities position of a securities account, and make them available for a specific purpose.

Copying a settlement restriction on securities is 1 option for the creation of a settlement restriction on securities.

It allows you to use an already existing settlement restriction on securities as a template and modify the content as you need.

You can also create your settlement restriction on securities including a link to another instruction or to a pool of instructions.

This business scenario is not relevant for CB users.

Privileges

To carry out this business scenario, you need the following privileges:

- Send new settlement restriction on securities either on a securities account or on behalf of an external CSD

- Unblock CoSD securities blocking related to cancelled CoSD settlement instructions on behalf of the relevant CSD in T2S
- Link to an instruction/pool reference belonging to a specific party
- Intra-position movements query
- Send new instruction using a specific instructing party

Reference

Further information on screens involved can be found in the screen reference part:

- Intra-position movements – search/list* screen [▶ 137]
- Intra-position movement - details* screen
- Intra-position movement - new* screen [▶ 151]

Instructions

1. Go to the *intra-position movements – search/list* screen:
Securities >> Settlement >> Intra-Position Movements
2. Enter all search criteria known to you about the settlement restriction on securities you want to copy.
3. Click on the *search* button.
 - ⇒ A list containing the search results is displayed on the screen.
 - ⇒ If the search retrieves only one settlement restriction on securities, the *intra position movement - details* screen is displayed directly. Proceed with step 6.
4. Select the settlement restriction on securities you want to copy by clicking on an entry in the list.
5. Click on the *details* button.
 - ⇒ The *intra-position movement - details* screen is displayed.
6. Click on the *copy* button.
 - ⇒ The *intra-position movement - new* screen is displayed taking by default the following fields from the original settlement restriction: instructing party BIC, instructing party parent BIC, intended settlement date, corporate action event id, priority, movement type, securities account securities, ISIN, quantity, balance from, balance to and restriction reference.
7. Check if all the default values that have been copied from the settlement restriction on securities are right for the new settlement restriction on securities or edit them if needed.
8. You can enter additional information about the settlement restriction on securities into the optional fields.

- To link your settlement restriction on securities to another instruction, click on the *add row* icon to add a new link.

- Select and add all the requested information to identify the instruction you want your settlement restriction on securities to be linked with.

- Click on the *submit changes* icon in the 'Options' column.

⇒ The link has been added to the list.

- If you want to add your settlement restriction on securities to a pool, enter the 'Pool Identification' field, 'Pool Instruction Counter' field and the 'Pool Reference Owner BIC' field instead.



Repetition

To add more links, repeat steps 9 to 10.

- To remove a link from the list of links to be added to the settlement restriction on securities, click on the *delete row* icon in the 'Options' column.

⇒ The link has been deleted from the list of links.



Alternatives

To set all fields to default value and blank out all optional fields, click on the *reset* button.

To cancel the process and return to the previous screen, click on the *cancel* button.

14. Click on the *submit* button.

15. Enter your PIN for digital signature purposes (NRO).

- ➔ The new settlement restriction on securities has been created based on a copied settlement restriction on securities.

3.6.1.3 View Settlement Restriction on Securities Details

Context of Usage

This business scenario describes how to view the details of a settlement restriction on securities.

Once a settlement restriction on securities is created in T2S it might be necessary for you to check its details to be aware of updates during the lifecycle of the settlement restriction.

Viewing settlement restriction on securities details is optional for the creation of a new settlement restriction on securities.

This business scenario is not relevant for CB users.

Privileges

To carry out this business scenario, you need the following privilege:

- Intra-position movements query

Reference

Further information on screens involved can be found in the screen reference part:

- Intra-position movements – search/list* screen [▶ 137]
- Intra-position movement – details* screen

Instructions

1. Go to the *intra-position movements – search/list* screen:
`Securities >> Settlement >> Intra-Position Movements`
2. Enter all search criteria known to you about the settlement restriction on securities for which you want to view the details.
3. Click on the *search* button.
 - ⇒ A list containing the search results is displayed on the screen.
 - ⇒ If the search retrieves only one settlement restriction on securities, the *intra-position movement – details* screen is displayed directly.



Alternative

To set all fields to default value and blank out all optional fields, click on the *re-set* button.

4. Select the settlement restriction on securities for which you want to view the details by clicking on the entry in the list.
5. Click on the *details* button.
 - ➔ The *intra-position movement – details* screen is displayed and you have viewed the settlement restriction on securities details.

3.6.2 Creation of a New Settlement Restriction on Cash

Overview

This business package describes the creation of a new settlement restriction on cash. You can create a new settlement restriction on cash either by entering all the necessary information or by copying it from an already existing settlement restriction on cash. Once the settlement restriction on cash has been created, you can also check its lifecycle in T2S.

To create a new settlement restriction on cash, carry out the following business scenarios in the predefined order and choose the business scenario relevant to you whenever options are given.

Business Scenarios

1. Create a new settlement restriction on cash
 - Enter a settlement restriction on cash [▶ 792]
 - Copy a settlement restriction on cash [▶ 794]
2. View settlement restriction on cash details [▶ 797]

3.6.2.1 Enter a Settlement Restriction on Cash

Context of Usage

This business scenario describes how to create a new settlement restriction on cash (intra-balance movement). You can block or reserve cash sub-balances on a T2S dedicated cash account. You can also create a new settlement restriction on cash to increase or decrease the cash in an existing restricted cash sub-balance. Optionally, you can include a restriction reference, a link to another instruction or to a pool of instructions.

Entering a new settlement restriction on cash is one option for the creation of a settlement restriction on cash.

Before you create a new settlement restriction on cash to increase or decrease an existing cash sub-balance, check if the restricted balance has been created, and if the restriction reference exists.

This business scenario is not relevant for CSD users.

Privileges

To carry out this business scenario, you need the following privileges:

- Send new settlement restriction on cash on a dedicated cash account
- Unblock CoSD cash blocking related to cancelled CoSD settlement instructions on behalf of the relevant CSD in T2S
- Link to an instruction/pool reference belonging to a specific party
- Intra-balance movements query
- Send new instruction using a specific instructing party

Reference

Further information on screens involved can be found in the screen reference part:

- Intra-balance movements – search/list* screen [▶ 423]
- Intra-balance movement - new* screen [▶ 437]

Instructions

1. Go to the *intra-balance movements – search/list* screen:
Cash >> Settlement >> Intra-balance movements
2. Click on the *new* button.
⇒ The *intra-balance movement - new* screen is displayed.
3. Enter all mandatory information in the ‘Intra-Balance Movement’ frame.
4. Optionally, you can enter additional information about the settlement restriction on cash into the optional fields.
5. To link your settlement restriction on cash to another instruction, click on the *add row* icon to add a new link.

The screenshot shows the 'Link' screen interface. At the top, there are navigation controls including 'Rows per page: 10' and 'page 1 of 1 - lines 0 to 0 of 0'. Below this is a table with the following columns: 'Link Type', 'Reference Type', 'Reference', 'Reference Owner', and 'Options'. The table currently contains no data, with the text 'No records found' displayed. A red box highlights the '+' icon located in the 'Options' column, which is used to add a new link.

6. Select and add all the requested information to identify the instruction you want your settlement restriction on cash to be linked to. Once all the information are introduced click on the *submit changes* icon in the ‘Options’ column.

This screenshot shows the 'Link' screen after a new link has been added. The table now contains one row of data. The columns are: 'Link Type' (with a dropdown arrow), 'Reference Type' (with a dropdown arrow), 'Reference' (with a text input field), 'Reference Owner' (with a text input field), and 'Options' (with a checkmark and a delete icon). A red box highlights the entire row of data, indicating that the link has been successfully added to the list.

- ⇒ The link has been added to the list.

- If you want to add your settlement restriction on securities to a pool, enter the 'Pool Identification' field, 'Pool Instruction Counter' field and the 'Pool Reference Owner BIC' field instead.

Link Type ^	Reference Type ^	Reference	Reference Owner	Options
No records found				
+				
Pool Instruction Reference	Pool Instruction Counter	Pool Reference Owner BIC		



Repetition

To add more links, repeat steps 5 to 6.

- To remove a link from the list of links to be added to the settlement restriction on cash, click on the *delete row* icon in the 'Options' column.

⇒ The link has been deleted from the list of links



Alternatives

To set all fields to default value and blank out all optional fields, click on the *reset* button.

To cancel the process and return to the previous screen, click on the *cancel* button.

- Click on the *submit* button.
- Enter your PIN for digital signature purposes (NRO).
➔ The new settlement restriction on cash has been created.

3.6.2.2 Copy a Settlement Restriction on Cash

Context of Usage

This business scenario describes how to create a new settlement restriction on cash (intra-balance movement) based on an already existing settlement restriction on cash. You can block or reserve cash sub-balances on a T2S dedicated cash account. You can also create a new settlement restriction on cash to increase or decrease the cash in an existing restricted cash sub-balance. Optionally, you can include a restriction reference, a link to another instruction or to a pool of instructions.

This business scenario is relevant for all situations where you want to create a new settlement restriction on cash based on the information of an already existing one in T2S.

Copying an existing settlement restriction on cash is one option for the creation of a settlement restriction on cash.

Before you create a new settlement restriction on cash to increase or decrease an existing cash sub-balance, check whether if the restricted balance has been created and if the restriction reference exists.

This business scenario is not relevant for CSD users.

Privileges

To carry out this business scenario, you need the following privileges:

- Send new settlement restriction on cash on a dedicated cash account
- Unblock CoSD cash blocking related to cancelled CoSD settlement instructions on behalf of the relevant CSD in T2S
- Link to an instruction/pool reference belonging to a specific party
- Intra-balance movements query
- Intra-balance movement audit trail list query
- Send new instruction using a specific instructing party

Reference

Further information on screens involved can be found in the screen reference part:

- Intra-balance movements – search/list* screen [▶ 423]
- Intra-balance movement - details* screen
- Intra-balance movement - new* screen [▶ 437]

Instructions

1. Go to the *intra-balance movements – search/list* screen:
Cash >> Settlement >> Intra-Balance Movements
2. Enter all search criteria known to you about the settlement restriction on cash you want to copy.
3. Click on the *search* button.
 - ⇒ A list containing the search results is displayed on the screen.
 - ⇒ If the search retrieves only one settlement restriction on cash, the *intra-balance movement - details* screen is displayed directly. Proceed with step 6.
4. Select the settlement restriction on cash you want to copy by clicking on an entry in the list.
5. Click on the *details* button.
 - ⇒ The *intra-balance movement - details* screen is displayed.
6. Click on the *copy* button.
 - ⇒ The *intra-balance movement - new* screen is displayed taking by default values of the following fields from the original settlement restriction on cash: instructing party BIC, instructing party parent BIC, actor reference, intended settlement date, dedicated cash account, amount, balance from and balance to, restriction reference.

7. Check if the default values are correct or edit them if needed.
8. You can enter additional information about the settlement restriction on cash into the optional fields.
9. To link your settlement restriction on cash to another instruction, click on the *add row* icon to add a new link.

10. Select and add all the requested information (reference type, reference, reference owner) to identify the instruction you want your settlement restriction on cash to be linked with.
11. Click on the *submit changes* icon in the 'Options' column.

⇒ The link has been added to the list.

12. If you want to add your settlement restriction on securities to a pool, enter the 'Pool Identification' field, 'Pool Instruction Counter' field and the 'Pool Reference Owner BIC' field instead.



Repetition

To add more links, repeat steps 9 to 10.

13. To remove a link from the list of links to be added to the settlement restriction on cash, click on the *delete row* icon in the 'Options' column.
 - ⇒ The link has been deleted from the list of links.



Alternatives

To set all fields to default value and blank out all optional fields, click on the *reset* button.

To cancel the process and return to the previous screen, click on the *cancel* button.

14. Click on the *submit* button.

15. Enter your PIN for digital signature purposes (NRO).

- ➔ The new settlement restriction on cash has been created based on a copied settlement restriction on cash.

3.6.2.3 View Settlement Restriction on Cash Details

Context of Usage

This business scenario describes how to view the details of a settlement restriction on cash. Once a settlement restriction on cash is created in T2S it might be necessary for you to check its details to be aware of updates during the lifecycle of the settlement restriction.

Viewing settlement restriction on cash details is optional for the creation of a new settlement restriction on cash.

This business scenario is not relevant for CSD users, external CSD users and CSD participants.

Privileges

To carry out this business scenario, you need the following privilege:

- Intra-balance movements query

Reference

Further information on screens involved can be found in the screen reference part:

- Intra-balance movements – search/list* screen [▶ 423]
- Intra-balance movement – details* screen

Instructions

1. Go to the *intra-balance movements – search/list* screen:
Cash >> Settlement >> Intra-Balance Movements
2. Enter all search criteria known to you about the settlement restriction on cash for which you want to view the details.
3. Click on the *search* button.
 - ⇒ A list containing the search results is displayed on the screen.
 - ⇒ If the search retrieves only one settlement restriction on cash, the *intra-balance movement – details* screen is displayed directly.



Alternative

To set all fields to default value and blank out all optional fields, click on the *reset* button.

4. Select the settlement restriction on cash for which you want to view the details by clicking on the entry in the list.
5. Click on the *details* button.
 - ➔ The *intra-balance movement – details* screen is displayed and you have viewed your settlement restriction on cash details.

3.6.3 Creation of a New Amendment Instruction for a Settlement Restriction on Securities

Overview

This business package describes the creation of a new amendment instruction for a settlement restriction on securities.

You can create a new amendment instruction for a settlement restriction on securities and afterwards you can check the information of the amendment instruction in T2S.

To create a new amendment instruction for a settlement restriction on securities, carry out the business scenarios in the predefined order and choose the business scenario relevant to you whenever options are given.

Business Scenarios

1. Create a new amendment instruction for a settlement restriction on securities
 - Add a link for a settlement restriction on securities [▶ 798]
 - Amend the priority for a settlement restriction on securities [▶ 801]
 - Remove a link for a settlement restriction on securities [▶ 803]
2. View amendment instruction for a settlement restriction on securities details [▶ 805]

3.6.3.1 Add a Link for a Settlement Restriction on Securities

Context of Usage

This business scenario describes how to link a settlement restriction on securities (intra-position movement). You can link your settlement restriction on securities in case you want to settle it at the same time, after or before the settlement of another settlement restriction or settlement instruction.

Adding a link for a settlement restriction on securities is 1 option for the creation of an amendment instruction for a settlement restriction on securities.

Before you add a link to your settlement restriction on securities, check whether it is neither cancelled nor partially settled nor settled. You can check the status of your settlement restriction on securities before creating the amendment instruction through the details screen as described in the business scenario view settlement restriction on securities details [▶ 791].

The number of links that can be added per amendment instruction is unbounded. If you want to modify an already existing link in your settlement restriction on securities, you first have to remove the existing link and then add a new link to your settlement restriction on securities.

This business scenario is not relevant for CB users.

Privileges

To carry out this business scenario, you need the following privileges:

- Amend process indicator of a settlement instruction/settlement restriction on securities either on a securities account or on behalf of the CSD in T2S or on behalf of an external CSD
- Amend process indicator of a non-modifiable settlement instruction on behalf of the instruction party of the underlying instruction
- Link to an instruction/pool reference belonging to a specific party
- Intra-position movements query
- Intra-position movement audit trail query
- Send new instruction using a specific instructing party

Reference

Further information on screens involved can be found in the screen reference part:

- Intra-position movements – search/list* screen [▶ 137]
- Intra-position movement - details* screen
- Amendment securities instruction - new* screen [▶ 103]

Instructions

1. Go to the *intra-position movements –search/list* screen:
Securities >> Settlement >> Intra-Position Movements
2. Enter all search criteria known to you about the settlement restriction on securities you want to link.
3. Click on the *search* button.
 - ⇒ A list containing the search results is displayed on the screen.
 - ⇒ If the search retrieves only 1 intra-position movement, the *intra-position movement - details* screen is displayed directly. Proceed with step 6.
4. Select the settlement restriction on securities you want to amend by clicking on an entry in the list.
5. Click on the *details* button.

- ⇒ The *intra-position movement – details* screen is displayed.
6. Click on the *amendment instruction* button, located on the lower left side of the screen.
- ⇒ The *amendment securities instruction - new* screen is displayed.
7. Enter all mandatory information in the 'General' frame.
8. Click on the *linkage information* radio button, located on the lower center side of the amendment securities screen.



Amendment Type

Priority Linkage Information

- ⇒ The 'Linkage Information' and 'Link' frames are displayed.
9. Select the *link* radio button to add a link.



Linkage Information

LINK UNLINK

10. Click on the *add row* icon in the 'Link' frame to display the links related enter fields.

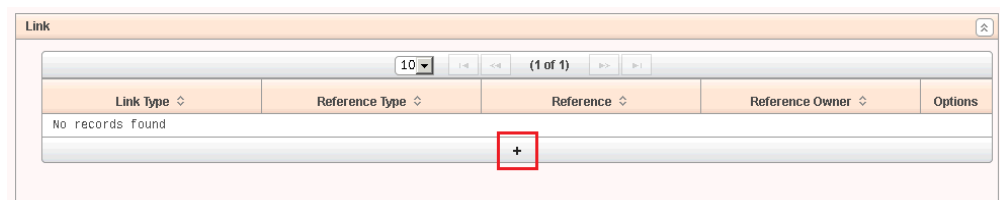

Link

Link Type	Reference Type	Reference	Reference Owner	Options
No records found				
				+

11. Enter the relevant information to identify the instruction you want your instruction to be linked with in the 'Link' frame and click on the *submit changes* icon in the 'Options' column.

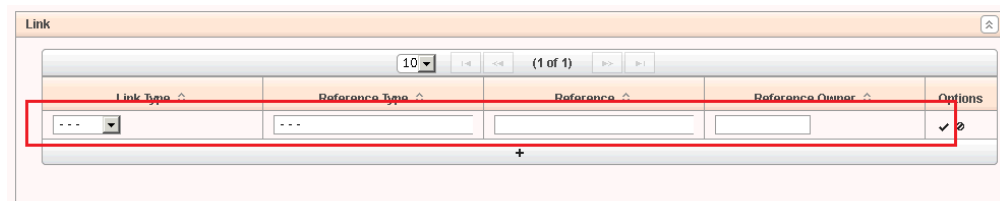

Link

Link Type	Reference Type	Reference	Reference Owner	Options
...	...			✓
				+

- ⇒ The link has been added to the list.
12. To remove an entry from the list of links to be added, click on the *cancel changes* icon in the 'Options' column.
- ⇒ The link has been deleted from the list.



Repetition

To add more links, repeat steps 10 to 11.
You can add as many links as you like.



Alternative

To set all fields to default value and blank out all optional fields, click on the *reset* button.

To cancel the process and return to the previous screen, click on the *cancel* button.

13. Click on the *submit* button.

14. Enter your PIN for digital signature purposes (NRO).

- ➔ A new amendment instruction to add a link for a settlement restriction on securities has been created.

3.6.3.2 Amend the Priority for a Settlement Restriction on Securities

Context of Usage

This business scenario describes how to amend the priority for a settlement restriction on securities (intra-position movement). You can create a new amendment instruction to amend the priority for your settlement restriction on securities in case you want to prioritise or delay its settlement.

Amending the priority for a settlement restriction on securities is one option for the creation of an amendment instruction for a settlement restriction on securities.

Before you amend the priority for your settlement restriction on securities, check whether it is neither cancelled nor settled. You can check the status of your settlement restriction on securities before creating the amendment instruction through the details screen as described in the business scenario view settlement restriction on securities details [▶ 791].

This business scenario is not relevant for CB users.

Privileges

To carry out this business scenario, you need the following privileges:

- Amend process indication for a non-modifiable settlement instruction on behalf of the instruction party of the underlying instruction
- Amend process indicator of a settlement instruction/settlement restriction on securities either on a securities account or on behalf of the CSD in T2S or on behalf of an external CSD
- Send new instruction using a specific instructing party
- Intra-position movements query
- Intra-position movement audit trail list query
- Link to an instruction/pool reference belonging to a specific party

Reference

Further information on screens involved can be found in the screen reference part:

- Intra-position movements – search/list* screen [▶ 137]

Instructions

- *Intra-position movement – details* screen
 - *Amendment securities instruction - new* screen [▶ 103]
1. Go to the *intra-position movements – search/list* screen:
Securities >> Settlement >> Intra-Position Movements
 2. Enter at least one general search criterion known to you about the settlement restriction on securities you want to amend.
 3. Click on the *search* button.
 - ⇒ A list containing the search results is displayed on the screen.
 - ⇒ If the search retrieves only one intra-position movement, the *intra-position movement - details* screen is displayed directly. Proceed with step 6.
 4. Select the settlement restriction on securities for which you want to amend the priority by clicking on an entry in the list.
 5. Click on the *details* button.
 - ⇒ The *intra-position movement – details* screen is displayed.
 6. Check the current priority value and click on the *amendment instruction* button.
 - ⇒ The *amendment securities instruction - new* screen is displayed.
 7. Click on the *priority* radio button, located on the lower left-hand side of the screen.

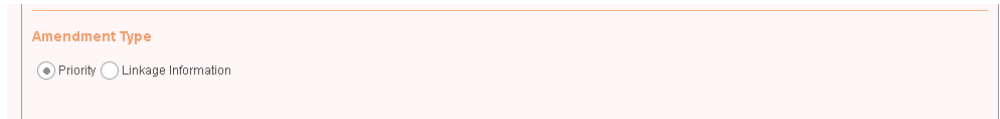

Amendment Type

Priority Linkage Information

⇒ The 'Priority' frame is displayed.

8. Select the new priority from drop-down menu.



Priority

Priority Level *

High

Normal

Reserved

**Alternative**

To set all fields to default value and blank out all optional fields, click on the *reset* button.

To cancel the process and return to the previous screen, click on the *cancel* button.

9. Click on *submit* button.
10. Enter your PIN for digital signature purposes (NRO).

- ➔ A new amendment instruction to change the priority of a settlement restriction on securities has been created.

3.6.3.3 Remove a Link for a Settlement Restriction on Securities

Context of Usage

This business scenario describes how to remove an existing link in a settlement restriction on securities (intra-position movement).

Removing a link for a settlement restriction on securities is 1 option for the creation of a new amendment instruction for a settlement restriction on securities.

Before you remove a link for your settlement restriction on securities, check if it is neither settled nor cancelled. You can check the status of your settlement restriction on securities before creating the amendment instruction through the details screen as described in the business scenario view settlement restriction on securities details [▶ 791].

The number of links that can be removed per amendment instruction is limited to the number of existing linkages in the settlement restriction.

If you want to modify an already existing link in your settlement restriction on securities, first you have to remove the existing link and then add a new link to your settlement restriction on securities.

This business scenario is not relevant for CB users.

Privileges

To carry out this business scenario, you need the following privileges:

- Intra-position movements query
- Link to an instruction/pool reference belonging to a specific party
- Amend process indicator of a settlement instruction/settlement restriction on securities either on a securities account or on behalf of the CSD in T2S or on behalf of an external CSD
- Send new instruction using a specific instructing party

Reference

Further information on screens involved can be found in the screen reference part:

- Intra-position movements– search/list* screen [▶ 137]
- Intra-position movement – details* screen
- Amendment securities instruction - new* screen [▶ 103]

Instructions

1. Go to the *intra-position movements– search/list* screen:
Securities >> Settlement >> Intra-Position Movements
2. Enter all search criteria known to you about the settlement restriction on securities you want to amend.
3. Click on the *search* button.

- ⇒ A list containing the search results is displayed on the screen.
- ⇒ If the search retrieves only one settlement restriction on securities, the *intra-position movement – details* screen is displayed directly. Proceed with step 6.
- 4. Select the settlement restriction on securities you want to amend by clicking on an entry in the list.
- 5. Click on the *details* button.
 - ⇒ The *intra-position movement – details* screen is displayed.
- 6. Click on the *amendment instruction* button, located on the lower left hand side of the screen.
 - ⇒ The *amendment securities instruction - new* screen is displayed.
- 7. Enter all mandatory information in the 'General' frame.
- 8. Click on the *linkage information* radio button, located on the lower center side of the amendment securities screen.

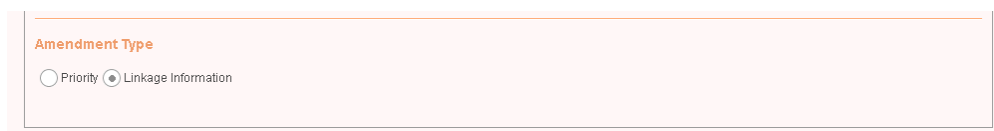

Amendment Type

Priority Linkage Information

- ⇒ The 'Linkage Information' and 'Link' frames are displayed.
 - 9. Click on the *unlink* radio button
- 
- Linkage Information
- LINK UNLINK
- ⇒ The existing links of the referenced settlement restriction on securities are displayed in the 'Link' frame below.
 - 10. Select the link(s) to be removed from the list.



Alternatives

To set all fields to default value and blank out all optional fields, click on the *reset* button.

To cancel the process and return to the previous screen, click on the *cancel* button.

- 11. Click on the *submit* button.
- 12. Enter your PIN for digital signature purposes (NRO).
 - ➔ A new amendment instruction to remove a link for a settlement restriction on securities has been created.

3.6.3.4 View Amendment Instruction for a Settlement Restriction on Securities Details

Context of Usage

This business scenario describes how to view the details of an amendment instruction for a settlement restriction on securities. Once an amendment instruction for a settlement restriction on securities has been created in T2S it might be necessary for you to check its details to be aware of updates during the lifecycle of the amendment instruction.

Viewing an amendment instruction for a settlement restriction on securities details is optional for the creation of a new amendment instruction for a settlement restriction on securities.

This business scenario is not relevant for CB users.

Privileges

To carry out this business scenario, you need the following privileges:

- Maintenance for intra-position movements and settlement instructions query
- Amendment instruction query for intra-position movements and settlement instructions

Reference

Further information on screens involved can be found in the screen reference part:

- Maintenance securities instructions – search/list* screen [▶ 164]
- Amendment securities instruction – details* screen [▶ 98]

Instructions

1. Go to the *maintenance securities instructions – search/list* screen:
Securities >> Settlement >> Maintenance Securities Instructions
2. Enter all search criteria known to you about the amendment instruction for a settlement restriction on securities for which you want to view the details.
3. Select the value 'Intra-Position Movement' in the 'Instruction Type' field.

4. Select the value 'Amendment Instruction' in the 'Maintenance Instruction Type' field.



Alternative

To set all fields to default value and blank out all optional fields, click on the *reset* button.

5. Click on the *search* button.
 - ⇒ A list containing the search results is displayed on the screen.
 - ⇒ If the search retrieves only one amendment instruction for a settlement restriction on securities, the *amendment securities instruction – details* screen is displayed directly.
 6. Select the amendment instruction for a settlement restriction on securities for which you want to view the details by clicking on an entry in the list.
 7. Click on the *details* button.
 - ⇒ The *amendment securities instruction – details* screen is displayed.
- ➔ You have viewed the details of an amendment instruction for a settlement restriction on securities.

3.6.4 Creation of a New Amendment Instruction for a Settlement Restriction on Cash

Overview

This business package describes the creation of a new amendment instruction for a settlement restriction on cash.

You can create a new amendment instruction for a settlement restriction on cash and afterwards check if the amendment instruction has been successfully created or executed.

To create a new amendment instruction for a settlement restriction on cash, carry out the business scenarios in the predefined order and choose the business scenario relevant to you whenever options are given.

Business Scenarios

1. Create a new amendment instruction for a settlement restriction on cash
 - Add a link for a settlement restriction on cash [▶ 807]
 - Amend the priority for a settlement restriction on cash [▶ 809]
 - Remove a link for a settlement restriction on cash [▶ 811]
2. View amendment instruction for a settlement restriction on cash details [▶ 813]

3.6.4.1 Add a Link for a Settlement Restriction on Cash

Context of Usage

This business scenario describes how to add a link for a settlement restriction on cash (intra-balance movement). You can link your settlement restriction on cash in case you want to settle it at the same time, after or before another settlement restriction or settlement instruction.

Adding a link for a settlement restriction on cash is one option for the creation of an amendment instruction for a settlement restriction on cash.

Before you add a link for a settlement restriction on cash, check whether it is neither cancelled nor partially settled nor settled. You can check the status of your settlement restriction on cash before creating the amendment instruction through the details screen as described in the business scenario view settlement restriction on cash details [▶ 797].

The number of links that can be added per amendment instruction is unbounded.

This business scenario is not relevant for CSD users.

Privileges

To carry out this business scenario, you need the following privileges:

- Link to an instruction/pool reference belonging to a specific party
- Amend process indicator settlement restriction on cash on a dedicated cash account
- Intra-balance movements query
- Intra-balance movement audit trail list query
- Send new instruction using a specific instructing party

Reference

Further information on screens involved can be found in the screen reference part:

- Intra-balance movements - search/list* screen [▶ 423]
- Intra-balance movement - details* screen
- Amendment cash instruction - new* screen [▶ 410]

Instructions

1. Go to the *intra-balance movements – search/list* screen:
Cash >> Settlement >> Intra-Balance Movements
2. Enter all search criteria known to you about the settlement restriction on cash you want to link.
3. Click on the *search* button.
 - ⇒ A list containing the search results is displayed on the screen.
 - ⇒ If the search retrieves only 1 intra-balance movement, the *intra-balance movement - details* screen is displayed directly. Proceed with step 6.
4. Select the settlement restriction on cash you want to amend by clicking on an entry in the list.

5. Click on the *details* button.
 - ⇒ The *intra-balance movement - details* screen is displayed.
6. Click on the *amendment instruction* button, located on the bottom of the screen.
 - ⇒ The *amendment cash instruction - new* screen is displayed.
7. Enter all mandatory information in the 'General' frame.
8. Click on the *linkage information* radio button, located on the lower center side of the screen.

Amendment Type

Priority Linkage Information

- ⇒ The 'Linkage Information' and 'Link' frames are displayed.
9. Select the *link* radio button to add a link.

Linkage Information

LINK UNLINK

10. Click on the *add row* icon in the 'Link' frame to display the links related enter fields.

Link Type	Reference Type	Reference	Reference Owner	Options
No records found				
				+

11. Enter the relevant information to identify the instruction you want your instruction to be linked with in the 'Link' frame and click on the *submit changes* icon in the 'Options' column.

Link Type	Reference Type	Reference	Reference Owner	Options
...	...			✓
				+

- ⇒ The link has been added to the list.
12. To remove an entry from the list of links to be added, click on the *cancel changes* icon in the 'Options' column.
 - ⇒ The link has been deleted from the list.

**Repetition**

To add more links, repeat steps 10 to 11.
You can add as many links as you like.

**Alternatives**

To set default criteria and blank out all optional fields, click on the *reset* button.
To cancel the process and return to the previous screen, click on the *cancel* button.

13. Click on the *submit* button.

14. Enter your PIN for digital signature purposes (NRO).

- ➔ A new amendment instruction to add a link for a settlement restriction on cash has been created.

3.6.4.2 Amend the Priority for a Settlement Restriction on Cash

Context of Usage

This business scenario describes how to amend the priority for a settlement restriction on cash (intra-balance movement). You can create a new amendment instruction to amend the priority for your settlement restriction on cash to prioritise or delay its settlement. In case the settlement restriction on cash was originally sent without a priority, you can set it or modify the existing one.

Amending the priority for a settlement restriction on cash is 1 option for the creation of an amendment instruction for a settlement restriction on cash.

Before you amend the priority for your settlement restriction on cash, check whether it is neither cancelled nor settled. You can check the status of your settlement restriction on cash before creating the amendment instruction through the details screen as described in the business scenario view settlement restriction on cash details [▶ 797].

This business scenario is not relevant for CSD users.

Privileges

To carry out this business scenario, you need the following privileges:

- Amend process indicator settlement restriction on cash on a dedicated cash account
- Link to an instruction/pool reference belonging to a specific party
- Send new instruction using a specific instructing party
- Intra-balance movements query
- Intra-balance movement audit trail list query

Reference Further information on screens involved can be found in the screen reference part:

- Intra-balance movements – search/list* screen [▶ 423]
- Intra-balance movement – details* screen
- Amendment cash instruction - new* screen [▶ 410]

Instructions

1. Go to the *intra-balance movements –search/list* screen:
Cash >> Settlement >> Intra-Balance Movements
2. Enter all search criteria known to you about the settlement restriction on cash for which you want to amend the priority.
3. Click on the *search* button.
 - ⇒ A list containing the search results is displayed on the screen.
 - ⇒ If the search retrieves only one intra-balance movement, the *intra-balance movement - details* screen is displayed directly. Proceed with step 6.
4. Select the settlement restriction on cash you want to amend by clicking on an entry in the list.
5. Click on the *details* button.
 - ⇒ The *intra-balance movement – details* screen is displayed.
6. Check the current priority value and click on the *amendment instruction* button.
 - ⇒ The *amendment cash instruction – new* screen is displayed.
7. Click on the *priority* radio button, located on the lower center side of the screen.

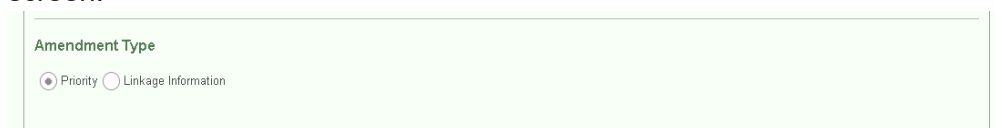

Amendment Type

Priority Linkage Information

- ⇒ The 'Priority' frame is displayed.
8. Select the new priority from the drop-down menu.



Priority

Priority Level *

High

Normal

Reserved



Alternatives

To set all fields to default value and blank out all optional fields, click on the *reset* button.

To cancel the process and return to the previous screen, click on the *cancel* button.

9. Click on the *submit* button.
10. Enter your PIN for digital signature purposes (NRO).
 - ➔ A new amendment instruction for a settlement restriction on cash has been created.

3.6.4.3 Remove a Link for a Settlement Restriction on Cash

Context of Usage

This business scenario describes how to remove an existing link in a settlement restriction on cash (intra-balance movement).

Removing a link for a settlement restriction on cash is one option for the creation of an amendment instruction for a settlement restriction on cash.

Before you remove a link for your settlement restriction on cash, check whether it is neither settled nor cancelled. You can check the status of your settlement restriction on cash before creating the amendment instruction through the details screen as described in the business scenario view settlement restriction on cash details [▶ 797].

The number of links that can be removed with one amendment instruction is limited to the number of existing linkages in the settlement restriction on cash.

If you want to modify an already existing link in your settlement restriction on cash, you have first to remove the existing link and then add a new link to your settlement restriction on cash.

This business scenario is not relevant for CSD users.

Privileges

To carry out this business scenario, you need the following privileges:

- Link to an instruction/pool reference belonging to a specific party
- Amend process indicator settlement restriction on cash on a dedicated cash account
- Send new instruction using a specific instructing party
- Intra balance movement query

Reference

Further information on screens involved can be found in the screen reference part:

- Intra-balance movements – search/list* screen [▶ 423]
- Intra-balance movement – details* screen
- Amendment cash instruction - new* screen [▶ 410]

Instructions

1. Go to the *intra-balance movements – search/list* screen:
Cash >> Settlement >> Intra-Balance Movements
2. Enter all search criteria known to you about the settlement restriction on cash you want to amend.

3. Click on the *search* button.
 - ⇒ A list containing the search results is displayed on the screen.
 - ⇒ If the search retrieves only one settlement restriction on cash, the *intra-balance movement – details* screen is displayed directly. Proceed with step 6.
4. Select the settlement restriction on cash you want to amend by clicking on an entry in the list.
5. Click on the *details* button.
 - ⇒ The *intra-balance movement – details* screen is displayed.
6. Click on the *amendment cash instruction* button.
 - ⇒ The *amendment cash instruction – new* screen is displayed.
7. Enter all mandatory information in the ‘General’ frame.
8. Click on the *linkage information* radio button, located on the lower center side of the *amendment cash instruction – new* screen.

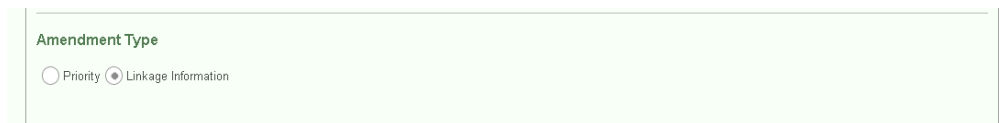

Amendment Type

Priority Linkage Information

- ⇒ The ‘Linkage Information’ and ‘Link’ frames are displayed.
9. Select the *unlink* radio button to remove a link.



Linkage Information

LINK UNLINK

- ⇒ The existing links of the referenced settlement restriction on cash are displayed in the ‘Link’ frame below.
10. Select the link(s) to be removed from the list.



Alternatives

To set all fields to default value and blank out all optional fields, click on the *reset* button.

To cancel the process and return to the previous screen, click on the *cancel* button.

11. Click on the *submit* button.
12. Enter your PIN for digital signature purposes (NRO).
 - ➔ A new amendment instruction to remove a link for a settlement restriction on cash has been created.

3.6.4.4 View Amendment Instruction for a Settlement Restriction on Cash Details

Context of Usage

This business scenario describes how to view the details of an amendment instruction for a settlement restriction on cash. Once an amendment instruction for a settlement restriction on cash has been created in T2S it might be necessary for you to check its details to be aware of updates during the lifecycle of the amendment instruction.

Viewing an amendment instruction for a settlement restriction on cash details is optional for the creation of a new amendment instruction for a settlement restriction on cash.

This business scenario is not relevant for CSD users.

Privileges

To carry out this business scenario, you need the following privileges:

- Maintenance instruction for intra-balance movements query
- Amendment instruction query for intra-balance movements

Reference

Further information on screens involved can be found in the screen reference part:

- Maintenance cash instructions – search/list* screen [▶ 448]
- Amendment cash instruction - details* screen [▶ 405]

Instructions

1. Go to the *maintenance cash instructions – search/list* screen:
Cash >> Settlement >> Maintenance Cash Instructions
2. Enter all search criteria known to you about the amendment instruction for a settlement restriction on cash for which you want to view the details.
3. Check that the value selected in the 'Maintenance Instruction Type' field is 'Amendment Instruction' (i.e. it is the default value for this field).

The screenshot shows a search criteria form for 'Maintenance Cash Instructions'. The form has several fields: Actor Reference, T2S Reference, Instructing Party Parent BIC, Instructing Party BIC, Dedicated Cash Account, Maintenance Instruction Type (highlighted with a red box and showing 'Amendment Instruction'), Execution Status (set to 'All'), Entry Date, and Cancellation Status (set to 'All').



Alternative

To set all fields to default value and blank out all optional fields, click on the *reset* button.

4. Click on the *search* button.
 - ⇒ A list containing the search results is displayed on the screen.

⇒ If the search retrieves only one amendment instruction for a settlement restriction on cash, the *amendment cash instruction - details* screen is displayed directly.

5. Select the amendment instruction for a settlement restriction on cash for which you want to view the details by clicking on an entry in the list.

6. Click on the *details* button.

⇒ The *amendment cash instruction – details* screen is displayed.

➔ You have viewed the details of an amendment instruction for a settlement restriction on cash.

3.6.5 Creation of a New Cancellation Instruction for a Settlement Restriction on Securities

Overview

This business package describes the creation of a new cancellation instruction for a settlement restriction on securities.

You can create a new cancellation instruction for a settlement restriction on securities and afterwards you can check the information of the cancellation instruction in T2S.

To create a new cancellation instruction for a settlement restriction on securities, carry out the following business scenarios in the predefined order.

Business Scenarios

1. Cancel a settlement restriction on securities [▶ 814]
2. View cancellation instruction for a settlement restriction on securities details [▶ 816]

3.6.5.1 Cancel a Settlement Restriction on Securities

Context of Usage

This business scenario describes how to create a new cancellation instruction for a settlement restriction on securities. This is necessary if you want to cancel a settlement restriction on securities so it is not processed further in T2S.

Cancelling a settlement restriction on securities is mandatory for the creation of a cancellation instruction for a settlement restriction on securities.

Before you create a new cancellation instruction for a settlement restriction on securities, check that it is not already cancelled nor settled. You can check the status of your settlement restriction on securities before creating the cancellation instruction through the details screen as described in the business scenario view settlement restriction on securities details [▶ 791].

This business scenario is not relevant for CB users.

Privileges

To carry out this business scenario, you need the following privileges:

- Intra-position movements query

- Intra-position movement audit trail list query
- Cancel non-modifiable instructions on behalf of the instruction party of the underlying settlement instruction
- Cancel settlement instruction/settlement restriction on securities either on a securities account or on behalf of the CSD in T2S, on behalf of an external CSD or on behalf of an administering party
- Send new instruction using a specific instructing party

Reference

Further information on screens involved can be found in the screen reference part:

- Intra-position movements – search/list* screen [▶ 137]
- Intra-position movement - details* screen
- Cancellation securities instruction - new* screen [▶ 117]

Instructions

1. Go to the *intra-position movements – search/list* screen:
`Securities >> Settlement >> Intra-Position Movements`
2. Enter at least one general search criterion known to you about the settlement restriction on securities for which you want to view the details.
3. Click on the *search* button.
 - ⇒ A list containing the search results is displayed on the screen.
 - ⇒ If the search retrieves only one settlement restriction on securities, the *intra-position movement - details* screen is displayed directly. Proceed with step 6.
4. Select the settlement restriction on securities you want to cancel by clicking on an entry in the list.
5. Click on the *details* button.
 - ⇒ The *intra-position movement - details* screen is displayed.
6. Click on the *cancellation instruction* button.
 - ⇒ The *cancellation securities instruction - new* screen is displayed.
7. Enter all relevant information in the 'General' frame.

**Alternative**

To set all fields to default value and blank out all optional fields, click on the *reset* button.

To cancel the process and return to the previous screen, click on the *cancel* button.

8. Click on the *submit* button.
9. Enter your PIN for digital signature purposes (NRO).

- ➔ A new cancellation instruction for a settlement restriction on securities has been created.

3.6.5.2 View Cancellation Instruction for a Settlement Restriction on Securities Details

Context of Usage

This business scenario describes how to view the details of a cancellation instruction for a settlement restriction on securities. Once the cancellation instruction for a settlement restriction on securities is created in T2S it might be necessary for you to check its details to be aware of updates during the lifecycle of the cancellation instruction.

Viewing a cancellation instruction for a settlement restriction on securities details is optional for the creation of a new cancellation instruction for a settlement restriction on securities.

This business scenario is not relevant for CB users.

Privileges

To carry out this business scenario, you need the following privileges:

- Maintenance for intra position movements and settlement instructions query
- Cancellation instruction query for intra-position movements and settlement instructions
- Cancellation instruction for intra-position movement or settlement instruction audit trail details query
- Amendment instruction query for intra-position movements and settlement instructions

Reference

Further information on screens involved can be found in the screen reference part:

- Maintenance securities instructions – search/list* screen [▶ 164]
- Cancellation securities instruction - details* screen [▶ 113]

Instructions

1. Go to the *maintenance securities instructions – search/list* screen:
Securities >> Settlement >> Maintenance Securities Instructions
2. Enter all search criteria known to you about the cancellation instruction for a settlement restriction on securities for which you want to view the details.
3. Select the value 'Intra-Position Movement' in the 'Instruction Type*' field.

4. Select the value 'Cancellation Instruction' in the 'Maintenance Instruction Type' field.

5. Select the value 'Cancellation Instruction' from the 'Maintenance Instruction Type' field in the 'General Criteria' frame to search for a cancellation instruction. If the relevant value is not selected, the default value 'All' applies.



Alternative

To set all fields to default value and blank out all optional fields, click on the *reset* button.

6. Click on the *search* button.

- ⇒ A list containing the search results is displayed on the screen.
- ⇒ If the search retrieves only one cancellation instruction for a settlement restriction on securities, the *cancellation securities instruction - details* screen is displayed directly.

7. Select the cancellation instruction for a settlement restriction on securities for which you want to view the details.

8. Click on the *details* button.

- ⇒ The *cancellation securities instruction – details* screen is displayed.

- ➔ You have viewed the details of a cancellation instruction for a settlement restriction on securities.

3.6.6 Creation of a New Cancellation Instruction for a Settlement Restriction on Cash

Overview

This business package describes the creation of a new cancellation instruction for a settlement restriction on cash.

You can create a new cancellation instruction for a settlement restriction on cash and afterwards you can check if the cancellation instruction has been successfully created or executed.

To create a new cancellation instruction for a settlement restriction on cash, carry out the following business scenarios in the predefined order.

Business Scenarios

1. Cancel a settlement restriction on cash [[▶ 818](#)]
2. View cancellation instruction for a settlement restriction on cash details [[▶ 819](#)]

3.6.6.1 Cancel a Settlement Restriction on Cash

Context of Usage

This business scenario describes how to create a new cancellation instruction for a settlement restriction on cash. This is necessary if you want to cancel a settlement restriction on cash so it is not further processed in T2S.

Cancelling a settlement restriction on cash is mandatory for the creation of a cancellation instruction for a settlement restriction on cash.

Before you create a new cancellation instruction for a settlement restriction on cash, check that it is neither already cancelled nor settled. You can check the status of your settlement restriction on cash before creating the cancellation instruction on the details screen as described in the business scenario view settlement restriction on cash details [[▶ 797](#)].

This business scenario is not relevant for CSD users.

Privileges

To carry out this business scenario, you need the following privileges:

- Intra-balance movements query
- Intra-balance movement audit trail list query
- Cancel settlement restriction on cash on a dedicated cash account
- Send new instruction using a specific instructing party

Reference

Further information on screens involved can be found in the screen reference part:

- Intra-balance movements – search/list* screen [[▶ 423](#)]
- Intra-balance movement - details* screen

Instructions□ *Cancellation cash instruction - new screen* [▶ 420]

1. Go to the *intra-balance movements – search/list* screen:
Cash >> Settlement >> Intra-Balance Movements
2. Enter at least one general search criterion known to you about the settlement restriction on cash for which you want to view the details.
3. Click on the *search* button.
 - ⇒ A list containing the search results is displayed on the screen.
 - ⇒ If the search retrieves only one settlement restriction on cash, the *intra-balance movement - details* screen is displayed directly. Proceed with step 6.
4. Select the settlement restriction on cash you want to cancel by clicking on an entry in the list.
5. Click on the *details* button.
 - ⇒ The *intra-balance movement - details* screen is displayed.
6. Click on the *cancellation instruction* button.
 - ⇒ The *cancellation cash instruction - new screen* is displayed.
7. Enter all relevant information in the 'General' frame.

**Alternative**

To set all fields to default value and blank out all optional fields, click on the *reset* button.

To cancel the process and return to the previous screen, click on the *cancel* button.

8. Click on the *submit* button.
9. Enter your PIN for digital signature purposes (NRO).
 - ➔ A new cancellation instruction for a settlement restriction on cash has been created.

3.6.6.2 View Cancellation Instruction for a Settlement Restriction on Cash Details

Context of Usage

This business scenario describes how to view the details of a cancellation instruction for a settlement restriction on cash. Once a cancellation instruction is created in T2S it might be necessary for you to check its details to be aware of updates during the lifecycle of the cancellation instruction.

Viewing a cancellation instruction for a settlement restriction on cash details is one option for the creation of a new cancellation instruction for a settlement restriction on cash.

This business scenario is not relevant for CSD users.

Privileges

To carry out this business scenario, you need the following privileges:

- Cancellation instructions for intra-balance movements query
- Maintenance instructions for intra-balance movements query
- Cancellation instruction for intra-balance movement audit trail list query
- Amendment instruction query for intra-balance movements
- Amendment instruction for intra-balance movement audit trail list query

Reference

Further information on screens involved can be found in the screen reference part:

- Maintenance cash instructions – search/list* screen [▶ 448]
- Cancellation cash instruction - details* screen [▶ 417]

Instructions

1. Go to the *maintenance cash instructions – search/list* screen:
Cash >> Settlement >> Maintenance Cash Instructions
2. Enter at least one general search criterion known to you about the cancellation instruction for a settlement restriction on cash for which you want to view the details.
3. Select the value 'Cancellation Instruction' in the 'Maintenance Instruction Type' field.

Search Criteria - Maintenance Cash Instructions

Actor Reference	T2S Reference	
<input type="text"/>	<input type="text"/>	
Instructing Party Parent BIC	Instructing Party BIC	Dedicated Cash Account
<input type="text"/>	<input type="text"/>	<input type="text"/>
Maintenance Instruction Type	Entry Date	Execution Date
<input type="text" value="Cancellation Instruction"/>	<input type="text"/>	<input type="text"/>
Amendment Instruction	Cancellation Status	
<input type="text"/>	<input type="text" value="All"/>	
Cancellation Instruction		
<input type="text"/>		

4. Click on the *search* button.
 - ⇒ A list containing the search results is displayed on the screen.
 - ⇒ If the search retrieves only one cancellation instruction for a settlement restriction on cash, the *cancellation cash instruction - details* screen is displayed directly.
5. Select the cancellation instruction for a settlement restriction on cash for which you want to view the details.



Alternative

To set all fields to default value and blank out all optional fields, click on the *reset* button.

6. Click on the *details* button.

⇒ The *cancellation cash instruction - details* screen is displayed.

- ➔ You have viewed the details of a cancellation instruction for a settlement restriction on cash.

3.6.7 View the list of links data preventing settlement of a settlement restriction on securities

Context of Usage

This business scenario describes how to view the list of data preventing settlement of a selected settlement restriction on securities.

When a linked settlement restriction on securities is unsettled, it might be useful for you to check the list of the settlement instructions or settlement restrictions preventing its settlement with the associated constraints.

This business scenario is not relevant for the following cases:

- Settled, cancelled settlement restrictions on securities
- Settlement restrictions on securities with an intended settlement date in the future

Privileges

To carry out this business scenario, you need the following privileges:

- Intra-position movements query

Reference

Further information on screens involved can be found in the screen reference part:

- Intra-position movements – search/list screen
- Intra-position movement – details screen
- Links preventing settlement – list screen

Instructions

1. Go to the intra-position movements – search/list screen:
Securities Settlement Intra-position Movements
2. Enter at least one general search criterion known to you about the settlement restriction on securities for which you want to view the links data preventing its settlement.
3. Click on the search button.
 - A list containing the search results is displayed on the screen
 - If the search retrieves only one settlement restriction on securities, the intra-position movement – details screen is displayed directly. Proceed with step 6.
4. Select the settlement on securities for which you want to view the links data preventing settlement by clicking on an entry in the list.
5. Click on the details button.
 - The intra-position movement – details screen is displayed.

6. Check the details of the settlement restriction on securities and click on the links button.
 - The links preventing settlement – list screen is displayed.
 - You have viewed the list of the settlement instructions and/or settlement instructions preventing the settlement of the selected settlement restriction on securities with the associated constraints.

3.6.8 View the list of links data preventing settlement of a settlement restriction on cash

Context of Usage

This business scenario describes how to view the list of data preventing settlement of a selected settlement restriction on cash.

When a linked settlement restriction on cash is unsettled, it might be useful for you to check the list of the settlement instructions or settlement restrictions preventing its settlement with the associated constraints.

This business scenario is not relevant for the following cases:

- Settled, cancelled settlement restrictions on cash
- Settlement restrictions on cash with an intended settlement date in the future

Privileges

To carry out this business scenario, you need the following privileges:

- Intra balance movement audit trail list query

Reference

Further information on screens involved can be found in the screen reference part:

- Intra-balance movements – search/list screen
- Intra-balance movement – details screen
- Links preventing settlement – list screen

Instructions

1. Go to the intra-balance-movements – search/list screen:
Cash Settlement Intra-balance Movements
2. Enter at least one general search criterion known to you about the settlement restriction on cash for which you want to view the links data preventing its settlement.
3. Click on the search button
 - A list containing the search results is displayed on the screen
 - If the search retrieves only one settlement restriction on cash, the intra-position movement – details screen is displayed directly. Proceed with step 6.
4. Select the settlement on cash for which you want to view the links data preventing settlement by clicking on an entry in the list.

5. Click on the details button.
 - The intra-balance movement – details screen is displayed.
6. Check the details of the settlement restriction on cash and click on the links button.
 - The links preventing settlement – list screen is displayed.
 - You have viewed the list of the settlement instructions and/or settlement instructions preventing the settlement of the selected settlement restriction on cash with the associated constraints.

3.7 Billing Data

3.7.1 Invoice Data Query

3.7.1.1 Querying Invoice Data

Context of Usage	This business package describes all activities the authorised user can perform for displaying the list of created Invoice Data and their related status.
Privileges	To carry out this business scenario, the user needs the following privilege: <ul style="list-style-type: none"><input type="checkbox"/> Invoice Data List Query
Reference	Further information on screens involved can be found in the screen reference part: <ul style="list-style-type: none"><input type="checkbox"/> Invoice data – search/list screen<input type="checkbox"/> Invoice data – details screen
Instructions	1. Go to the Invoice Data – search/list screen: Billing >> Invoice Data >> Search Billing >> Manual Correction >> Search >> Click on Invoice Data button ⇒ The Invoice Data – search/list is displayed.

2. Enter all the information of interest, choosing whether to specify the 'Service', the 'Party BIC', the Start/End date of the relevant Billing period, or the Invoice Number (only if already used for the creation of an Invoice which is not cancelled).

3. Click on the Search button.

➔ The Invoice Data List is displayed. {Split book approach}

3.7.2 Querying Itemised Invoice Data

Context of Usage

This business package describes all activities the authorised user can perform for displaying the list of Itemised Invoice Data that compose the Invoice Data that could be selected from the previous screen.

Privileges

To carry out this business scenario, the user needs the following privilege:

- Itemised Invoice Data List Query
- Itemised Invoice Data Details Query

Reference

Further information on screens involved can be found in the screen reference part:

- Itemised invoice data – search/list screen
- Itemised invoice data – details screen

Instructions

1. Go to the Itemised Invoice Data – search/list screen:
Billing >> Invoice Data – search/list screen >> Click on the Details button >> click on the Itemised Invoice Data Search button
⇒ The Itemised Invoice Data – search/list is displayed.

2. Enter all the information of interest, choosing whether to specify the 'Securities Account number', the 'Cash Account number', the 'Parent BIC' or the 'Party BIC'.

ITEMISED INVOICE DATA LIST			
Invoice Data			
Service:	T2 RTGS COMPONENT	Parent BIC:	SYSENT2SK1
Party BIC:	NCBKICR0001	Parent BIC:	Bank 1
Period Start Date:	2020-02-28	Period End Date:	2022-02-28
Status:	Active	Creation Date:	
Invoice Number:	ABCFG5000		

Securities Account number: Cash Account number:

Parent BIC: Party BIC:

3. Click on the Search button.

➔ The Itemised Invoice Data List is displayed. {Split book approach}

3.7.3 Querying PDF Invoice

Context of Usage

This business package describes all activities the authorised user can perform for displaying the list of PDF Invoices and their related status.

Privileges

To carry out this business scenario, the user needs the following privilege:

- Manage Billing Data

Reference

Further information on screens involved can be found in the screen reference part:

- PDF invoice – search/list screen

Instructions

1. Go to the PDF Invoice – search/list screen:
Billing >> PDF Invoice >> Search
⇒ The PDF Invoice – search/list screen is displayed.
2. Enter all the information of interest, choosing whether to specify the 'Service', the 'Status', the 'Parent BIC', the 'Party BIC' and the Start/End date of the relevant Billing period.
3. Click on the Search button.

⇒ **The list of PDF Invoices is displayed.**

4. **Select one or more than one PDF Invoices and then click on the Download PDF button.**

⇒ **The PDF Invoice or the list of PDF Invoices is downloaded. {Split book approach}**

3.8 Configuring of a Manual Correction

3.8.1 Create a New Manual Correction

Context of Usage

This business package describes how to create a new Manual Correction starting from a predefined group of Invoice Data.

In the example below the user performs:

- A Template Correction that leads to the substitution of the previously configured Invoice Footer;**
- A Manual Correction with the introduction of an additional service item containing an Amount and a VAT rate.**

Privileges

To carry out this business scenario, the user needs the following privilege:

- Invoice Data List Query**
- Manual Correction Details Query**
- Manage Manual Correction**

Reference

Further information on screens involved can be found in the screen reference part:

- Invoice Data – search/list screen**
- Manual Correction – details screen**
- Manual Correction – new/edit screen**

Instructions

1. **Go to the Invoice Data – search/list screen:
Billing >> Invoice Data >> Search
Billing >> Manual Correction >> Search >> Click on Invoice Data button**

- ⇒ **The Invoice Data – search/list screen is displayed.**
- 2. **Enter all the information of interest, choosing whether to specify the ‘Service’, the ‘Party BIC’, the Start/End date of the relevant Billing period.**
- 3. **Click on the Search button.**
 - ⇒ **The Invoice Data List is displayed.**
- 4. **Select an Invoice Data and click on Manual Correction button.**
 - ⇒ **The Manual Correction – details screen is displayed**

Status	Name	Service	Service	Rate	VAT Rate	VAT am	Amount	Quantity	Unit Price	Type	Total a
Active	Additional info	Settlement Serv	5001					200	10 €	Credit	2,000 €
Active	Updated Code	Information Serv	CO02		10%	300 €	3,000 €			Credit	3,000 €

- 5. **Click on Add Manual Correction button.**
 - ⇒ **The Manual Correction – new/edit screen is displayed**
- 6. **Enter the ‘Footer Text’.**
- 7. **Click the Submit Row button in the Template Correction section.**
- 8. **Enter the ‘Name’, select the ‘Service Item Category’, enter the ‘Service Item Code’; then enter the ‘Amount’, the ‘VAT Rate’ and select the ‘Type of correction (Credit/Debit)’.**
- 9. **Click the Submit Row button in the Manual Correction section.**

➔ **The new Manual Correction has been created and is shown in the list.**

The screenshot displays the 'MANUAL CORRECTION NEW' interface. It is divided into two main sections: 'Invoice Data Set' and 'Manual Correction'.

Invoice Data Set: This section contains a table with the following data:

Service:	T2 RTGS COMPONENT	Invoice Data Status:	Generated
Parent BIC:	SYSENT2SX1	Party BIC:	NCBKICR0001
Period Start Date:	2020-12-08	Period End Date:	2020-12-28

Template Correction: This section includes a 'Footer Text' input field and a table listing template corrections. A message states 'Max number of Template Correction allowed reached'. The table contains one row:

Status	Footer Text
Active	footer

Manual Correction: This section contains various input fields for creating a correction, including Name, Service Item Code, VAT Rate, Amount, Unit Price, Total Amount, Service Category, Rate, VAT Amount, Quantity, and Type of correction (Credit/Debit). Below these fields is a table listing the created manual corrections:

Status	Name	Service	Service	Rate	VAT Rate	VAT am.	Amount	Quantity	Unit Price	Type of Cont.	Total a.
Active	Additional Info	Settlement Serv	Serv5001					200	10 €	Credit	2.000 €
Active	Updated Code	Information Sen	COD2		10%	300 €	3.000 €			Credit	3.000 €

{Split book approach}

3.8.2 Create a New Template Correction (CB)

Context of Usage

This business package describes how to create a new Template Correction starting from a predefined group of Invoice Data.

In the example below the CB user performs a Template Correction that leads to the substitution of the previously configured Invoice Footer in a Participant Invoice.

Privileges

To carry out this business scenario, the user needs the following privilege:

- Invoice Data List Query**
- Manual Correction Details Query**
- Manage Manual Correction**

Reference

Further information on screens involved can be found in the screen reference part:

Instructions

- **Invoice Data – search/list screen**
 - **Manual Correction – details screen**
 - **Manual Correction – new/edit screen**
1. **Go to the Invoice Data – search/list screen:**
Billing >> Invoice Data >> Search
Billing >> Manual Correction >> Search >> Click on Invoice Data button
 ⇒ **The Invoice Data – search/list screen is displayed.**
 2. **Enter all the information of interest, choosing whether to specify the ‘Service’, the ‘Parent BIC’, the ‘Party BIC’, the Start/End date of the relevant Billing period.**
 3. **Click on the Search button.**
 ⇒ **The Invoice Data List is displayed.**
 4. **Select an Invoice Data and click on Manual Correction button.**
 ⇒ **The Manual Correction – details screen is displayed**

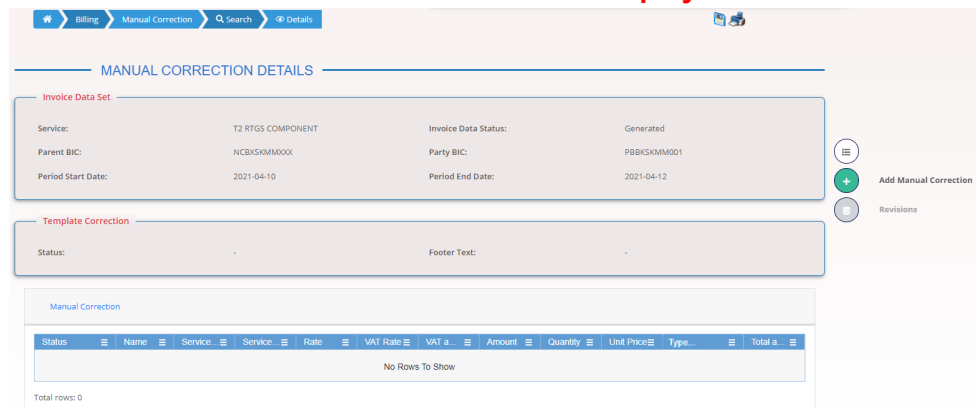

5. **Click on Add Manual Correction button.**
 ⇒ **The Manual Correction – new/edit screen is displayed**
6. **Enter the ‘Footer Text’.**
7. **Click the Submit Row button in the Template Correction section.**

➔ **The new Template Correction has been created and is shown in the list.**

The screenshot displays the 'MANUAL CORRECTION NEW' interface. At the top, there is a navigation bar with 'Billing', 'Manual Correction', 'Search', 'Details', and '+ New'. Below this, the 'MANUAL CORRECTION NEW' title is centered. The interface is divided into three main sections:

- Invoice Data Set:** A table with the following data:

Service:	T2 RTGS COMPONENT	Invoice Data Status:	Generated
Parent BIC:	NCBXSMMXXX	Party BIC:	PBBKSMM001
Period Start Date:	2021-04-10	Period End Date:	2021-04-12
- Template Correction:** A section containing a 'Footer Text' input field, a '+', and a 'x' button. Below it, a message states 'Max number of Template Correction allowed reached'. A table below shows one row:

Status	Footer Text
Active	New Footer Text

 The total rows are 1.
- Manual Correction:** A form with various input fields:
 - Name: [input field]
 - Service Category: [dropdown menu]
 - Service Item Code: [Choose... button]
 - Rate: [input field with % symbol]
 - VAT Rate: [input field with % symbol]
 - VAT Amount: [input field]
 - Amount: [input field]
 - Quantity: [input field]
 - Unit Price: [input field]
 - Type of correction (Credit/Debit): [dropdown menu]
 - Total Amount: [input field]
 Below the form is a table with columns: Status, Name, Servic..., Servic..., Rate, VAT Rate, VAT a..., Amount, Quantity, Unit Pri..., Type..., Total a... The table is currently empty, showing 'No Rows To Show'. The total rows are 0.

{Split book approach}

~~3.8.3 Create a New Manual Correction (CB)~~

Context of Usage

~~This business package describes how to create a new Manual Correction starting from a predefined group of Invoice Data.~~

~~In the example below the CB user performs a Manual Correction that inserts quantity and unit price of a new Service Item for a Participant Invoice.~~

Privileges

~~To carry out this business scenario, the user needs the following privilege:~~

- ~~Invoice Data List Query~~
- ~~Manual Correction Details Query~~
- ~~Manage Manual Correction~~

Reference

~~Further information on screens involved can be found in the screen reference part:~~

- ~~Invoice Data – search/list screen~~

Instructions

- **Manual Correction – details screen**
 - **Manual Correction – new/edit screen**
1. **Go to the Invoice Data – search/list screen:-**
Billing >> Invoice Data >> Search
Billing >> Manual Correction >> Search >> Click on Invoice Data button
 ⇒ **The Invoice Data – search/list screen is displayed.**
 2. **Enter all the information of interest, choosing whether to specify the ‘Service’, the ‘Parent BIC’, the ‘Party BIC’, the Start/End date of the relevant Billing period.**
 3. **Click on the Search button.**
 ⇒ **The Invoice Data List is displayed.**
 4. **Select an Invoice Data and click on Manual Correction button.**
 ⇒ **The Manual Correction – details screen is displayed**

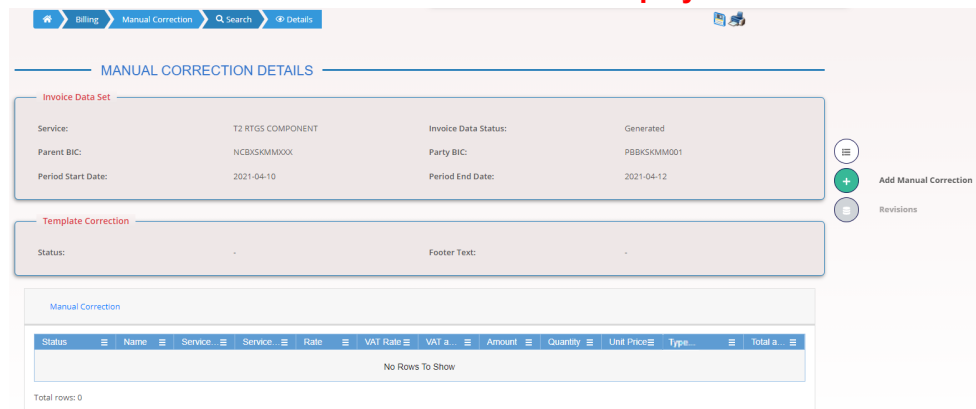

5. **Click on Add Manual Correction button.**
 ⇒ **The Manual Correction – new/edit screen is displayed**
6. **Enter the ‘Name’, select the ‘Service Item Category’, enter a new ‘Service Item Code’; then enter the ‘Quantity’, ‘Unit Price’ and select the ‘Type of Correction (Credit/Debit)’.**
7. **Click the Submit Row button in the Manual Correction section.**

⇒ **The new Manual Correction has been created and is shown in the list.**

{Split book approach}

3.8.4 Create a New Manual Correction without propagation (ECB)

Context of Usage

This business package describes how to create a new Manual Correction starting from a predefined group of Invoice Data.

In the example below the ECB user performs a Manual Correction that amends the quantity of an existing Service Item in a System Entity Invoice. No propagation to Participant Invoices is performed.

Privileges

To carry out this business scenario, the user needs the following privilege:

- Invoice Data List Query**
- Manual Correction Details Query**
- Manage Manual Correction**

Reference ~~Further information on screens involved can be found in the screen reference part:~~

- ~~Invoice Data – search/list screen~~
- ~~Manual Correction – details screen~~
- ~~Manual Correction – new/edit screen~~

Instructions 1. ~~Go to the Invoice Data – search/list screen:-
Billing >> Invoice Data >> Search
Billing >> Manual Correction >> Search >> Click on Invoice Data button~~

~~⇒ The Invoice Data – search/list screen is displayed.~~

2. ~~Enter all the information of interest, choosing whether to specify the ‘Service’, the ‘Party BIC’, the Start/End date of the relevant Billing period.~~

3. ~~Click on the Search button.~~

~~⇒ The Invoice Data List is displayed.~~

4. ~~Select an Invoice Data and click on Manual Correction button.~~

~~⇒ The Manual Correction – details screen is displayed~~

The screenshot displays the 'MANUAL CORRECTION DETAILS' screen. It is divided into three main sections:

- Invoice Data Set:** A table with the following data:

Service:	T2 RTGS COMPONENT	Invoice Data Status:	Generated
Parent BIC:	TCSOTCS000X	Party BIC:	NCEBXSMM000X
Period Start Date:	2021-04-10	Period End Date:	2021-04-12
- Template Correction:** A table with the following data:

Status:	-	Footer Text:	-
---------	---	--------------	---
- Manual Correction:** A table with the following columns: Status, Name, Service, Service, Rate, VAT Rate, Amount, Quantity, Unit Price, Type, Total a. The table currently shows 'No Rows To Show'.

5. ~~Click on Add Manual Correction button.~~

~~⇒ The Manual Correction – new/edit screen is displayed~~

6. ~~Enter the ‘Name’, select the ‘Service Item Category’, enter or select the ‘Service Item Code’; then enter the ‘Quantity’ and select the ‘Type of Correction (Credit/Debit)’.~~

7. ~~Click the Submit Row button in the Manual Correction section.~~

➔ **The new Manual Correction has been created and is shown in the list.**

Home > Billing > Manual Correction > Details > + New
🔍 🗨️

MANUAL CORRECTION NEW

Invoice Data Set

Service:	T2 RTGS COMPONENT	Invoice Data Status:	Generated
Parent BIC:	TCSOTCS00XX	Party BIC:	NCBASKMM00XX
Period Start Date:	2021-04-10	Period End Date:	2021-04-12

☰ ✕ Cancel

Template Correction

Footer Text:

✕ +

Status	Footer Text
No Rows To Show	

Total rows: 0 🗑️

Manual Correction

Name: <input style="width: 95%;" type="text"/>	Service Category: <input style="width: 95%;" type="text"/>
Service Item Code: <input style="width: 95%;" type="text" value="Choose..."/>	Rate: <input style="width: 95%;" type="text"/>
VAT Rate: <input style="width: 95%;" type="text"/>	VAT Amount: <input style="width: 95%;" type="text"/>
Amount: <input style="width: 95%;" type="text"/>	Quantity: <input style="width: 95%;" type="text"/>
Unit Price: <input style="width: 95%;" type="text"/>	Type of correction (Credit/Debit): <input style="width: 95%;" type="text"/>
Total Amount: <input style="width: 95%;" type="text"/>	

✕ +

Status	Name	Service C.	Ser.	Rate	VAT	VAT..	Am...	Qua	Unit...	Type of Corr.	Tota
Active	Manual Correction No Propagation Settlement Serv	5001						100		Credit	

Total rows: 1 🗑️

Propagation

Parent BIC: <input style="width: 95%;" type="text" value="NCBASKMM00XX"/>	Party BIC (mandatory): <input style="width: 95%;" type="text"/>
Manual Correction: <input style="width: 95%;" type="text"/>	<div style="border: 1px solid #ccc; padding: 5px; margin-top: 5px;"> <input style="width: 100%;" type="text" value="Filter..."/> <ul style="list-style-type: none"> <input type="checkbox"/> PBBKSESS001 <input type="checkbox"/> PBBKSKMM001 <input type="checkbox"/> PBBKSKMM002 <input type="checkbox"/> ANSYSKMM001 <input type="checkbox"/> PBBKSKMM003 <input type="checkbox"/> PBBKSKMM007 <input type="checkbox"/> PBBKSKMM009 <input type="checkbox"/> PBBKSKMM004 <input type="checkbox"/> PBBKSKMM005 <input type="checkbox"/> PBBKSKMM006 </div>

✕ +

Manual Correction	Parent BIC	Party BIC
No Rows To Show		

Total rows: 0 🗑️

{Split book approach}

3.8.5 Propagation of a Manual Correction to one Participant (ECB)

- Context of Usage** This business package describes how to propagate a Manual Correction starting from an existing and active Manual Correction on an Invoice Data. In the example below the ECB user propagates a Manual Correction that amends the quantity of an existing Service Item to a Participant Invoice.
- Privileges** To carry out this business scenario, the user needs the following privilege:
- Invoice Data List Query
 - Manual Correction Details Query
 - Manage Manual Correction
- Reference** Further information on screens involved can be found in the screen reference part:
- Invoice Data – search/list screen
 - Manual Correction – details screen
 - Manual Correction – new/edit screen
- Instructions**
1. Go to the Invoice Data – search/list screen:-
Billing >> Invoice Data >> Search
Billing >> Manual Correction >> Search >> Click on Invoice Data button
⇒ The Invoice Data – search/list screen is displayed.
 2. Enter all the information of interest, choosing whether to specify the ‘Service’, the ‘Party BIC’, the Start/End date of the relevant Billing period.
 3. Click on the Search button.
⇒ The Invoice Data List is displayed.
 4. Select an Invoice Data and click on Manual Correction button.
⇒ The Manual Correction – details screen is displayed

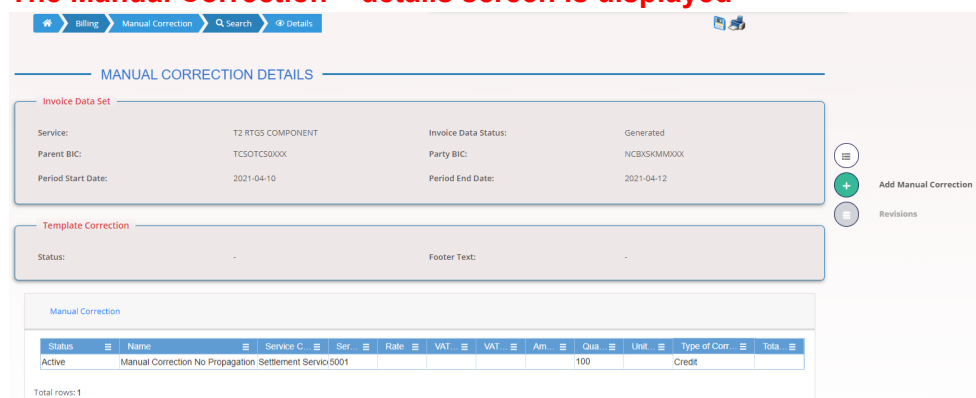

5. Click on Add Manual Correction button.

- ⇒ **The Manual Correction – new/edit screen is displayed**
- 6. Select the ‘Manual Correction’, select the ‘Party BIC’ of the Participant.**
- 7. Click the Submit Row button in the Propagation section.**
- ➔ **The Manual Correction has been propagated and is shown in the list.**

{Split book approach}

3.8.6 Propagation of a Manual Correction to all Participants (ECB)

Context of Usage

This business package describes how to propagate a Manual Correction starting from an existing and active Manual Correction on a new Service Item already inserted in a System Entity Invoice Data.

In the example below the ECB user propagates the Manual Correction to all the Participants under the Central Bank scope.

Privileges

To carry out this business scenario, the user needs the following privilege:

- Invoice Data List Query
- Manual Correction Details Query
- Manage Manual Correction

Reference

Further information on screens involved can be found in the screen reference part:

- Invoice Data – search/list screen
- Manual Correction – details screen
- Manual Correction – new/edit screen

Instructions

1. Go to the Invoice Data – search/list screen:
Billing >> Invoice Data >> Search
Billing >> Manual Correction >> Search >> Click on Invoice Data button
⇒ The Invoice Data – search/list screen is displayed.
2. Enter all the information of interest, choosing whether to specify the ‘Service’, the ‘Party BIC’, the Start/End date of the relevant Billing period.
3. Click on the Search button.
⇒ The Invoice Data List is displayed.
4. Select an Invoice Data and click on Manual Correction button.
⇒ The Manual Correction – details screen is displayed

MANUAL CORRECTION DETAILS

Invoice Data Set

Service:	T2 RTGS COMPONENT	Invoice Data Status:	Generated
Parent BIC:	TCSOTCS000X	Party BIC:	NCBXS0MM000X
Period Start Date:	2021-04-10	Period End Date:	2021-04-12

Template Correction

Status:	-	Footer Text:	-
---------	---	--------------	---

Manual Correction

Status	Name	Service	Service	Rate	VAT Rate	VAT a.	Amount	Quantity	Unit Pri.	Type of Corr.	Total a.
Active	Free Text	Settlement SenFREE						100	0.2	Debt	20 €

Total rows: 1

5. ~~Click on Add Manual Correction button.~~
 - ⇒ ~~The Manual Correction – new/edit screen is displayed~~
6. ~~Select the 'Manual Correction', select the 'Party BIC' of all the Participants.~~
7. ~~Click the Submit Row button in the Propagation section.~~

➔ **The Manual Corrections have been propagated and are shown in the list.**

Navigation: Billing > Manual Correction > Details > + New

MANUAL CORRECTION NEW

Invoice Data Set

Service:	T2 RTGS COMPONENT	Invoice Data Status:	Generated
Parent BIC:	TCSOTCS00XX	Party BIC:	NCBXSMM00XX
Period Start Date:	2021-04-10	Period End Date:	2021-04-12

Template Correction

Footer Text:

Status	Footer Text
No Rows To Show	

Total rows: 0

Manual Correction

Name: Service Category:

Service Item Code: Rate: %

VAT Rate: % VAT Amount:

Amount: Quantity:

Unit Price: Type of correction (Credit/Debit):

Total Amount:

Status	Name	Servic	Servic	Rate	VAT Rate	VAT a	Amount	Quantity	Unit Pri	Type of Corr	Total a
Active	Free Text	Settlement Ser	FREE				100	0.2		Debit	20 €

Total rows: 1

Propagation

Parent BIC: NCBXSMM00XX Party BIC (mandatory):

Manual Correction:

- Filter...
- PBBKSESS001
- PBBKSKMM001
- PBBKSKMM002
- ANSYSKMM001

Manual Correction	Parent BIC	Party BIC
Free Text	NCBXSMM00XX	PBBKSESS001
Free Text	NCBXSMM00XX	PBBKSKMM001
Free Text	NCBXSMM00XX	PBBKSKMM002
Free Text	NCBXSMM00XX	ANSYSKMM001

Total rows: 4

{Split book approach}

4 Trouble Management System Part

4.1 General

General

The Trouble Management System (TMS) part offers an overview of the TMS screens that are available in U2A mode. The aim of this section is to provide a guide which describes and explains the usage and the functionalities of the TMS external interface to the relevant users.

TMS is a tool and database which is used to track and follow-up on relevant communication between the T2S users and the T2S Service Desk for which a trouble case has been created.

The T2S Service Desk is responsible for opening a trouble case ticket whenever it is contacted by a T2S user who would like to raise a service request or who experiences problems (e. g. due to abnormal situations or reduced performance) with T2S. In TMS a trouble case is classified either as service request or incident.

A *service request* is a trouble case to track information requests or information on any specific issue that is part of standard operation.

An *incident* is a trouble case reporting any event which does not fall within standard operation and causes an interruption or reduction in quality of a T2S service.

Access to TMS

Please refer to ESMIG qualified configurations document annexed to the ESMIG UDFS.

Statuses in TMS

A status is assigned by the T2S Service Desk to every trouble case and will change during its life cycle. For a complete list of statuses see chapter 4.2.2 (*Trouble Case – Details Screen*).

Priorities in TMS

The T2S Service Desk has to assign a priority to every trouble case created in TMS. There are four different priority types in TMS: *Low*, *Medium*, *Urgent*, and *Critical*. *Low* is usually assigned to service requests and any incident which does not affect the T2S performance directly. *Medium* is the priority for trouble case incidents affecting the performance moderately but with no impact on the general availability of T2S services. *Urgent* is the priority assigned to incident cases which describe the unavailability of one or more services or a heavily impacted overall performance of the T2S system. A workaround has to be put in place within the defined time according to the T2S Service Level Agreement. In case of complete unavailability of the T2S System, the priority *Critical* is assigned to the TMS trouble case.

Screen Reference Part

The screen reference part offers a complete overview of all TMS screens that are available to the T2S users including a detailed description.

- Context of Usage** The context of usage explains what a screen displays, the functions of the screen and which information you can get from it, e.g. the resolution progress of a trouble case. It also defines the different options of monitoring of a trouble case.
- Screen Access** This part explains how to access the different available screens. Please note that with the exception of the main screen, all screens are pop-up screens which can be accessed directly from the main screen. Screen access explains how to open these pop-up screens.
- Reference** This section lists all references to the business scenarios containing the respective screen (reference to the user instructions part).
- Screenshot** The screenshot can help to ease orientation for the work in the UHB. Deviations between the screenshot and the description are possible in case of specific selections you have made. Values shown in the screenshot might deviate from the default values indicated in the description.
- Field Description** The field description provides all the relevant information related to the respective field name.

It is structured in table format with a separate table for each frame. The following illustration explains the structure of a field description.

1 Case Details	
Institution	Shows the parent BIC and party BIC related to the trouble case.
2 Trouble Case ID	3 Shows the alphanumeric number of the trouble case assigned by the system. 4 Note: In case of incidents and service requests the trouble case ID always starts with 'INC', in case of problems with 'PBI'.
Customer Trouble Case ID	Shows the number of the trouble case assigned by the customer.
Case Type	Shows the case type of the trouble case from the possible values: <ul style="list-style-type: none"> Incident Problem Service Request
Open Date	Shows the date and time of the opening of the trouble case. 5 Displayed format is: MM/DD/YYYY hh:mm:ss

Position No.	Element	Description
1	Frame Name	The frame name indicates the respective name of each screen frame.
2	Field Name	The field name indicates the respective name of each screen field.
3	Field description	The field description indicates the field type as well as possible and/or required content.
4	Additional Information	The additional information section indicates useful information regarding a field's or button's function.
5	Required/Displayed format	<p>The required/displayed format indicates all field format requirements related to the fields. If there is more than 1 format requirement, they are separated with a comma.</p> <p>In read-only fields the displayed format is only mentioned, if the field content is ambiguous. This applies especially to date fields.</p> <p>The following keywords are used for the format requirements:</p> <ul style="list-style-type: none"> <input type="checkbox"/> 'Digit' indicates numbers <input type="checkbox"/> 'Character' indicates a character from the SWIFT-x character set

User Instructions Part

The user instructions part comprises scenarios adapted from typical user workflows grouped in a business package.

List of Business Scenarios

This section contains a list of all business scenarios which represent individual workflows and consist of single action steps, intermediate results and a final result.

Instructions

The instructions section explains in detail which steps have to be taken e. g. to view a trouble case. This section lists all references to the screens involved, sorted by their appearance in the business scenario.

4.2 Screen Reference Part

4.2.1 Trouble Case – Search/List Screen

Context of Usage

This screen contains a number of search fields. By inputting the relevant data, you can search for trouble cases (incidents/requests and problems) related to your system entity, trouble cases opened by parties related to your system entity and in addition trouble cases of general importance visible to all parties (default). After selecting an entry, you can proceed further by clicking on the buttons below.

Screen Access

This screen is the main screen of the Trouble Management System (TMS) and appears directly when accessing the TMS.

References

User Instructions Part

This screen is part of the following business scenarios:

- View trouble case [▶ 862]
- Execute a report [▶ 862]

Screenshot

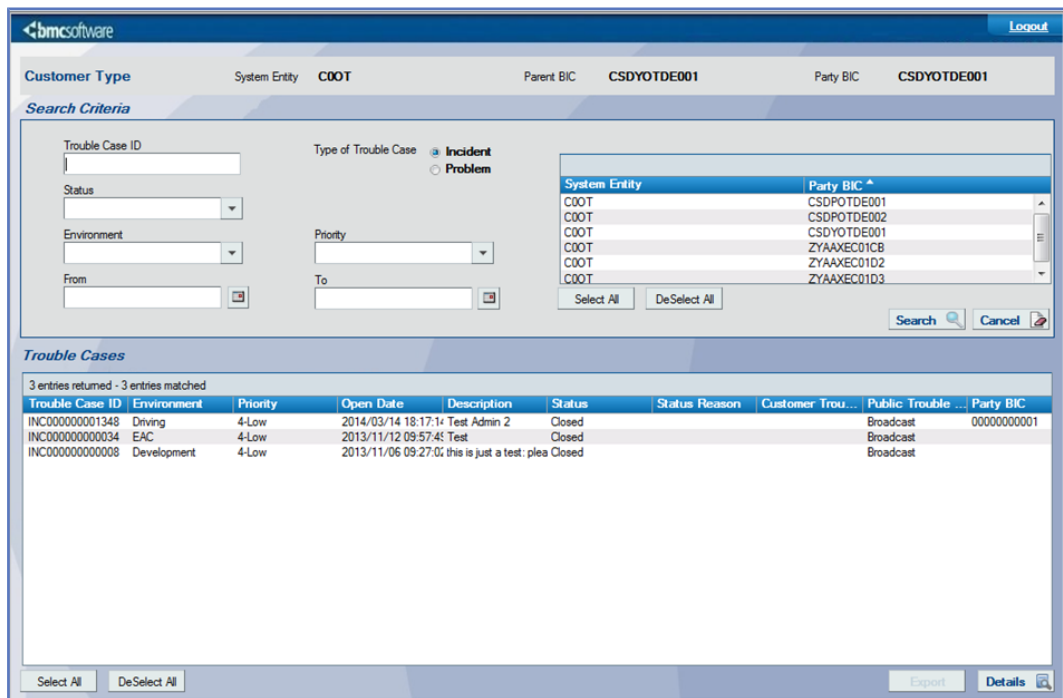

Illustration 143: Trouble case – list screen

Field Description

Trouble Case – Search/List	
Customer Type	
System Entity	Shows the system entity your user belongs to.
Parent BIC	Shows the parent BIC of your party.
Party BIC	Shows all the possible party BICs related to the parent BIC.
Search Criteria	

Trouble Case – Search/List	
Trouble Case ID	Enter a trouble case ID number of the T2S TMS for single search (available both for problems and incidents).
Status	<p>Select the status of the trouble case.</p> <p>If the type of trouble case is set to 'Incident', select the status of the trouble case from the possible values:</p> <ul style="list-style-type: none"> <input type="checkbox"/> Assigned <input type="checkbox"/> In Progress <input type="checkbox"/> Pending <input type="checkbox"/> Resolved <input type="checkbox"/> Closed <input type="checkbox"/> Cancelled <input type="checkbox"/> All Open <input type="checkbox"/> (Empty) (default value no filter will be applied) <p>If the type of trouble case is set to 'Problem', select the status of the trouble case from the possible values:</p> <ul style="list-style-type: none"> <input type="checkbox"/> Under Review <input type="checkbox"/> Request for Authorization <input type="checkbox"/> Assigned <input type="checkbox"/> Under Investigation <input type="checkbox"/> Pending <input type="checkbox"/> Completed <input type="checkbox"/> Rejected <input type="checkbox"/> Closed <input type="checkbox"/> Cancelled <input type="checkbox"/> All Open <input type="checkbox"/> (Empty) (default value no filter will be applied)
Environment	<p>Select the environment of the trouble case.</p> <ul style="list-style-type: none"> <input type="checkbox"/> Production <input type="checkbox"/> Customer <input type="checkbox"/> INTEG <input type="checkbox"/> Driving <input type="checkbox"/> Development <input type="checkbox"/> IAC

Trouble Case – Search/List	
	<input type="checkbox"/> EAC <input type="checkbox"/> MIG1 <input type="checkbox"/> MIG2 <input type="checkbox"/> UTEST <input type="checkbox"/> (Empty) (default value no filter will be applied)
Priority	Select the Priority of the trouble case. <input type="checkbox"/> 1 – Critical <input type="checkbox"/> 2 – Urgent <input type="checkbox"/> 3 – Medium <input type="checkbox"/> 4 – Low <input type="checkbox"/> (Empty) (default value no filter will be applied)
Type of Trouble Case*	Select the type of trouble case from the possible values: <input type="checkbox"/> Incident (default value) <input type="checkbox"/> Problem Note: Case type = Request is classified as type of trouble case = Incident (further distinction available in the ‘Trouble Cases part’).
From	Enter the lower bound of the search range for the date and time from which the trouble case is opened or use the <i>calendar</i> icon. Required format is: YYYY/MM/DD hh:mm:ss The ‘From’ date and time must be a valid date earlier than or equal to the current business and earlier than or equal to the ‘To’ date and time. Reference for error message [▶ 1452]: <input type="checkbox"/> ARERR10000
To	Enter the upper bound of the search range for the date and time until which the trouble case is opened or use the <i>calendar</i> icon. Required format is: YYYY/MM/DD hh:mm:ss The ‘To’ date and time must be a valid date later than or equal to the ‘From’ date and time. Reference for error message [▶ 1452]: <input type="checkbox"/> ARERR10000

Trouble Case – Search/List	
Costumer	Select the party BIC related to your system entity you want to include in your search result. You can select more than one related party BIC.
Trouble Cases	
Trouble Case ID	Shows the alphanumeric number of the trouble case assigned by the system. Note: In case of incidents and requests, the Trouble Case ID always starts with 'INC'. In case of problems the Trouble Case ID always starts with 'PBI'.
Environment	Shows the environment chosen for the ticket. Normally it is the environment where the issue was detected.
Priority	Shows the priority assigned to the ticket from the possible values: <input type="checkbox"/> Critical <input type="checkbox"/> Urgent <input type="checkbox"/> Medium <input type="checkbox"/> Low
Open Date	Shows the date and time the trouble case have been opened. Displayed format is: YYYY/MM/DD hh:mm:ss
Description	Shows the description of the trouble case.
Status	Shows the current status of the trouble case. If the type of trouble case is set to 'Incident', this field shows the status from the possible values: <input type="checkbox"/> Assigned <input type="checkbox"/> In Progress <input type="checkbox"/> Pending <input type="checkbox"/> Resolved <input type="checkbox"/> Closed <input type="checkbox"/> Cancelled <input type="checkbox"/> All Open <input type="checkbox"/> (Empty) (default value no filter will be applied) If the type of trouble case is set to 'Problem', this field shows the status from the possible values:

Trouble Case – Search/List	
	<ul style="list-style-type: none"> <input type="checkbox"/> Under Review <input type="checkbox"/> Request for Authorization <input type="checkbox"/> Assigned <input type="checkbox"/> Under Investigation <input type="checkbox"/> Pending <input type="checkbox"/> Completed <input type="checkbox"/> Rejected <input type="checkbox"/> Closed <input type="checkbox"/> Cancelled <input type="checkbox"/> All Open <input type="checkbox"/> (Empty) (default value no filter will be applied)
Status Reason	<p>Shows the reason for the current status of the trouble case.</p> <p>If the status of the trouble case is set to 'Pending', this field shows the reason from the possible values:</p> <ul style="list-style-type: none"> <input type="checkbox"/> Automated Resolution Reported <input type="checkbox"/> Client Hold <input type="checkbox"/> Client Action Required <input type="checkbox"/> Support Contact Hold <input type="checkbox"/> Local Site Action Required <input type="checkbox"/> Purchase Order Approval <input type="checkbox"/> Registration Approval <input type="checkbox"/> Supplier Delivery <input type="checkbox"/> Third Party Vendor Action Required <input type="checkbox"/> Infrastructure Change (only if Case Type is set to 'Problem') <input type="checkbox"/> Pending Original Problem (only if Case Type is set to 'Problem') <input type="checkbox"/> Request <input type="checkbox"/> Monitoring Incident <input type="checkbox"/> Monitoring Problem (only if Case Type is set to 'Problem') <input type="checkbox"/> Future Enhancement

Trouble Case – Search/List	
	<p>If the status of the trouble case is set to 'Resolved', this field shows the reason from the possible values:</p> <ul style="list-style-type: none"> <input type="checkbox"/> Automated Resolution Reported <input type="checkbox"/> Customer Follow-Up Required <input type="checkbox"/> Temporary Corrective Action <input type="checkbox"/> Future Enhancement <input type="checkbox"/> Monitoring Incident <input type="checkbox"/> No Further Action Required <p>If the status of the trouble case is set to 'Closed', this field shows the reason from the possible values:</p> <ul style="list-style-type: none"> <input type="checkbox"/> Successful <input type="checkbox"/> Successful with Problem <input type="checkbox"/> Unsuccessful <input type="checkbox"/> (Empty) <p>If the status of the trouble case is set to 'Completed', this field shows the reason from the possible values:</p> <ul style="list-style-type: none"> <input type="checkbox"/> Known Error <input type="checkbox"/> Solution Database <input type="checkbox"/> Enhancement Request <input type="checkbox"/> Unresolvable <p>If the status of the trouble case is set to 'Cancelled', this field shows the reason from the possible values:</p> <ul style="list-style-type: none"> <input type="checkbox"/> No longer a Causal CI (only in case of incident/request ticket) <input type="checkbox"/> Duplicate Investigation (only if Case Type is set to 'Problem') <input type="checkbox"/> Not a Defect (only in case of problem tickets) <input type="checkbox"/> (Empty) <p>This field is only filled in if the status of the trouble case is equal to 'Pending', 'Resolved' or 'Completed' or if the status is equal to 'Closed' or 'Cancelled' and the status reason has been indicated during data acquisition.</p>
Customer Trouble Case ID	Shows the internal identification reported by the Customer itself when opening the ticket.

Action Buttons

Trouble Case – Search/List	
Public Trouble Case	Shows whether the trouble is public from the possible values: <input type="checkbox"/> Yes <input type="checkbox"/> Broadcast
Party BIC	It shows the party BIC of the system entity for which the ticket was open.
Action Buttons	
Select All	This function enables you to select all values from the related list.
DeSelect All	This function enables you to deselect all values from the related list.
Search	This function enables you to start a search according to the criteria entered. The results are displayed in a list on the same screen. Next screen: <input type="checkbox"/> <i>Trouble case – search/list</i> screen Reference for error message [▶ 1452]: <input type="checkbox"/> ARERR10000
Cancel	This function enables you to cancel the process and set all search fields to default value. Next screen: <input type="checkbox"/> <i>Trouble case – search/list</i> screen
Export	This function enables you to export the search result with all the appropriately visible fields as a report. Next screen: <input type="checkbox"/> <i>Trouble case - export</i> screen [▶ 855]
Details	This function enables you to display the details of the selected trouble case. Next screen: <input type="checkbox"/> <i>Trouble case – details</i> screen [▶ 849]

4.2.2 Trouble Case - Details Screen

Context of Usage

This screen displays detailed information on a trouble case.

Screen Access *Trouble case – list* screen >> Click on the *details* button

References **User Instructions Part**

This screen is part of the following business scenario:

View trouble case [▶ 862]

Screenshot

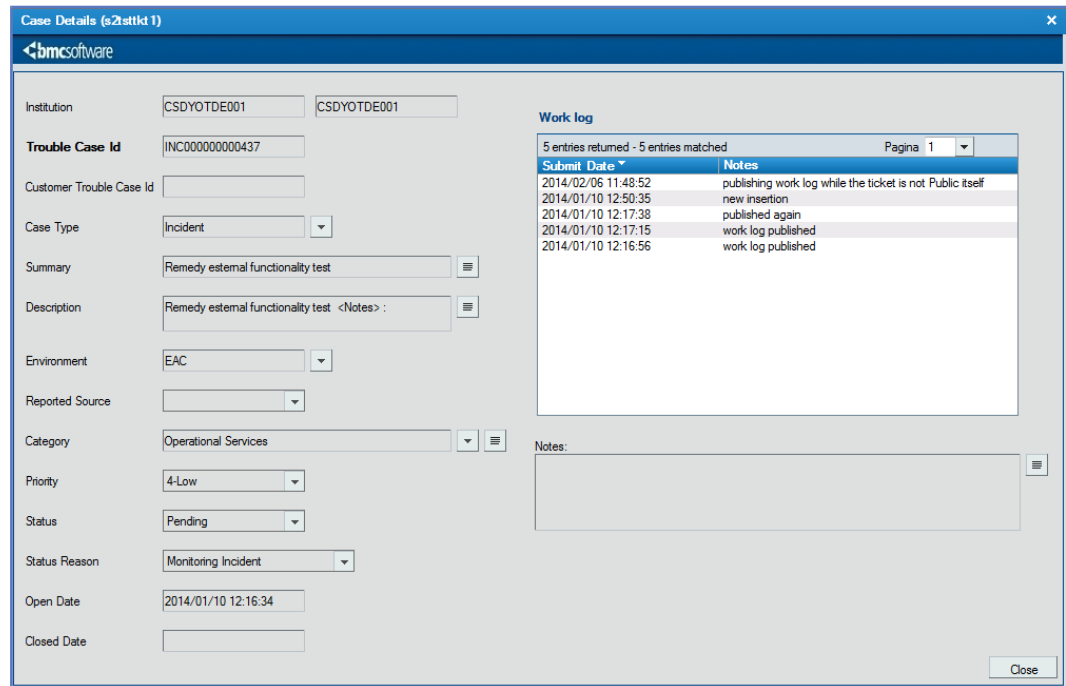

Illustration 144: Trouble case – details screen

Field Description

Case Details	
Institution	Shows the parent BIC and party BIC related to the trouble case.
Trouble Case ID	Shows the alphanumeric number of the trouble case assigned by the system. Note: In case of incidents and requests, the Trouble Case ID always starts with 'INC'. In case of problems the Trouble Case ID always starts with 'PBI'.
Customer Trouble Case ID	Shows the alphanumeric identification of the trouble case reported by the customer when opening the ticket.
Case Type	Shows the case type of the trouble case from the possible values: <input type="checkbox"/> Incident <input type="checkbox"/> Problem <input type="checkbox"/> Request
Summary	Shows a brief summary of the trouble case.

Case Details	
Description	Shows in addition to a brief summary also a detailed description of the trouble case.
Environment	Shows the environment related to the trouble case from one of the possible values for L2 tickets (other possible internal environment are although present in the search functionalities for this field): <ul style="list-style-type: none"> <input type="checkbox"/> Production <input type="checkbox"/> Customer <input type="checkbox"/> EAC <input type="checkbox"/> MIG1 <input type="checkbox"/> MIG2
Reported Source	Shows the method the trouble case has been reported from one of the possible values: <ul style="list-style-type: none"> <input type="checkbox"/> Direct Input <input type="checkbox"/> Email <input type="checkbox"/> External Escalation <input type="checkbox"/> Fax <input type="checkbox"/> Phone <input type="checkbox"/> Voice Mail <input type="checkbox"/> Other <p>This field is only filled in if the reporting method has been indicated during data acquisition of the trouble case.</p>
Category	Shows the category the trouble case is assigned to from the possible values: <ul style="list-style-type: none"> <input type="checkbox"/> ALL OR MULTIPLE MODULES <input type="checkbox"/> Infrastructure <input type="checkbox"/> Interface <input type="checkbox"/> Lifecycle Management (LCMM) <input type="checkbox"/> Liquidity Management <input type="checkbox"/> Migration Tools <input type="checkbox"/> Operational Services <input type="checkbox"/> SECURITY REQUEST <input type="checkbox"/> Settlement <input type="checkbox"/> Reference Data Management

Case Details	
	<ul style="list-style-type: none"> <input type="checkbox"/> Statistics, Reports, Queries and Archive <input type="checkbox"/> UNKNOWN OR NO MODULES
Priority	<p>Shows the priority of the trouble case from the possible values:</p> <ul style="list-style-type: none"> <input type="checkbox"/> 4-Low <input type="checkbox"/> 3-Medium <input type="checkbox"/> 2-Urgent <input type="checkbox"/> 1-Critical
Status	<p>Shows the current status of the trouble case.</p> <p>If the type of trouble case is set to 'Incident', this field shows the status from the possible values:</p> <ul style="list-style-type: none"> <input type="checkbox"/> Assigned <input type="checkbox"/> In Progress <input type="checkbox"/> Pending <input type="checkbox"/> Resolved <input type="checkbox"/> Closed <input type="checkbox"/> Cancelled <p>If the type of trouble case is set to 'Problem', this field shows the status from the possible values:</p> <ul style="list-style-type: none"> <input type="checkbox"/> Under Review <input type="checkbox"/> Assigned <input type="checkbox"/> Under Investigation <input type="checkbox"/> Pending <input type="checkbox"/> Completed <input type="checkbox"/> Closed <input type="checkbox"/> Cancelled
Status Reason	<p>Shows the reason for the current status of the trouble case.</p> <p>If the status of the trouble case is set to 'Pending', this field shows the reason from the possible values:</p> <ul style="list-style-type: none"> <input type="checkbox"/> Automated Resolution Reported <input type="checkbox"/> Client Hold <input type="checkbox"/> Client Action Required

Case Details	
	<ul style="list-style-type: none"> <input type="checkbox"/> Support Contact Hold <input type="checkbox"/> Local Site Action Required <input type="checkbox"/> Purchase Order Approval <input type="checkbox"/> Registration Approval <input type="checkbox"/> Supplier Delivery <input type="checkbox"/> Third Party Vendor Action Required <input type="checkbox"/> Infrastructure Change (only if Case Type is set to 'Problem') <input type="checkbox"/> Pending Original Problem (only if Case Type is set to 'Problem') <input type="checkbox"/> Request <input type="checkbox"/> Monitoring Incident <input type="checkbox"/> Monitoring Problem (only if Case Type is set to 'Problem') <input type="checkbox"/> Future Enhancement <p>If the status of the trouble case is set to 'Resolved', this field shows the reason from the possible values:</p> <ul style="list-style-type: none"> <input type="checkbox"/> Automated Resolution Reported <input type="checkbox"/> Customer Follow-Up Required <input type="checkbox"/> Temporary Corrective Action <input type="checkbox"/> Future Enhancement <input type="checkbox"/> Monitoring Incident <input type="checkbox"/> No Further Action Required <p>If the status of the trouble case is set to 'Closed', this field shows the reason from the possible values:</p> <ul style="list-style-type: none"> <input type="checkbox"/> Successful <input type="checkbox"/> Successful with Problem <input type="checkbox"/> Unsuccessful <input type="checkbox"/> (Empty) <p>If the status of the trouble case is set to 'Completed', this field shows the reason from the possible values:</p> <ul style="list-style-type: none"> <input type="checkbox"/> Known Error <input type="checkbox"/> Solution Database

Case Details	
	<ul style="list-style-type: none"> <input type="checkbox"/> Enhancement Request <input type="checkbox"/> Unresolvable <p>If the status of the trouble case is set to 'Cancelled', this field shows the reason from the possible values:</p> <ul style="list-style-type: none"> <input type="checkbox"/> No longer a Causal CI (only if Case Type is set to 'Incident') <input type="checkbox"/> Duplicate Investigation (only if Case Type is set to 'Problem') <input type="checkbox"/> Not a Defect <input type="checkbox"/> (Empty) <p>This field is only filled in if the status of the trouble case is equal to 'Pending', 'Resolved' or 'Completed' or if the status is equal to 'Closed' or 'Cancelled' and the status reason has been indicated during data acquisition.</p>
Open Date	<p>Shows the date and time of the opening of the trouble case.</p> <p>Displayed format is: YYYY/MM/DD hh:mm:ss</p>
Closed Date	<p>Shows the date and time of the closure of the trouble case.</p> <p>Displayed format is: YYYY/MM/DD hh:mm:ss</p>
Work Log (Customer relevant information entered by the T2S operator are shown)	
Submit Date	<p>Shows date and time when the information present in the Work log-Notes is entered.</p> <p>Displayed format is: YYYY/MM/DD hh:mm:ss</p>
Notes	<p>Shows the work log information added to the trouble case by the T2S operator. Each entry is displayed in a different row and can be selected for complete display in the bottom 'Notes' dedicated area.</p>
Action Buttons	
Close	<p>This function enables you to close the <i>details</i> screen and return to the previous screen.</p> <p>Next screen:</p> <ul style="list-style-type: none"> <input type="checkbox"/> <i>Trouble case list</i> screen [▶ 843]

4.2.3 Trouble Case - Export Screen

Context of Usage This screen enables you to export your trouble cases as a report (PDF, Power-Point, Word, PostScript or Excel) or to print a report.

Screen Access *Trouble case – list* screen >> Click on the *report* button

References **User Instructions Part**

This screen is part of the following business scenario:

Execute a report [▶ 862]

Screenshot

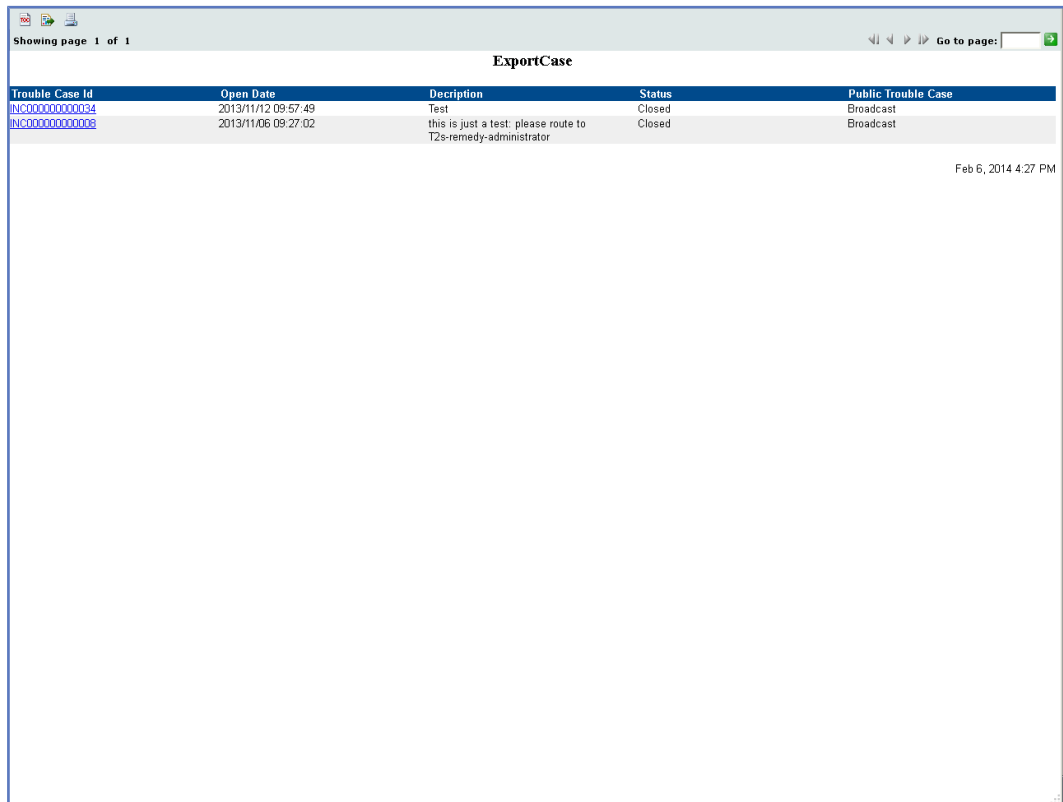

Trouble Case Id	Environment	Priority	Open Date	Description	Status	Status Reason	Customer Trouble Case Id	Public Trouble Case	Party BIC
INC000000001348	Driving	4-Low	2014/03/14 18:17:14	Test Admin 2	Closed			Broadcast	0000000001
INC000000000660	EAC	4-Low	2014/01/23 16:16:32	test of external interface <Notes> : test of external interface	Closed	Automated Resolution Reported		Yes	CSDYOTDE001
INC000000000670	EAC	4-Low	2014/01/17 17:06:39	test of external interface <Notes> : test of external interface	Closed	Successful	123456	Yes	CSDYOTDE001
INC000000000639	EAC	2-Urgent	2014/01/16 15:07:40	Cash > Liquidity > Data Changes > Data Change Details screen UZA BIC AGBLLT2XXXX User PB-AGBLLT2X-2 Description : Business Validation: Accepted liquidity transfer Execution: full execution, 4-eyes-principle, 1. User Detailed Trigger: must use an <Notes> : LOT1 - LQMG-LT-284-15-1 - Approval screen not showing all details Remedy external functionality test <Notes> :	Closed	Successful	143	Yes	CSDYOTDE001
INC000000000437	EAC	4-Low	2014/01/10 12:16:34	Remedy external functionality test <Notes> :	Pending	Monitoring Incident		Yes	CSDYOTDE001
INC000000000414	IAC	4-Low	2014/01/09 14:14:18	Testing External interface of TMS <Notes> : Description : I am testing the External TMS interface entering Public visibility	In Progress			Yes	CSDPOTDE001
INC000000000034	EAC	4-Low	2013/11/12 09:57:49	Test	Closed			Broadcast	
INC000000000008	Development	4-Low	2013/11/06 09:27:02	this is just a test, please route to T2s-remedy-administrator	Closed			Broadcast	

Illustration 145: Trouble case – export screen

Field Description

Customer Type	
System Entity	Shows the system entity your user belongs to.
Parent BIC	Shows the parent BIC of your party.
Party BIC	Shows all the possible party BIC related to the parent BIC.
Search Criteria	
Trouble Case ID	Field where it is possible to enter a trouble case ID number of the T2S TMS for single search (available both for problems and incidents).
Status	Select the status of the trouble case. If the type of trouble case is set to 'Incident', select the status of the trouble case from one of the possible values: <input type="checkbox"/> Assigned <input type="checkbox"/> In Progress <input type="checkbox"/> Pending <input type="checkbox"/> Resolved <input type="checkbox"/> Closed <input type="checkbox"/> Cancelled <input type="checkbox"/> All Open

Customer Type	
	<input type="checkbox"/> (Empty) (default value no filter will be applied) If the type of trouble case is set to 'Problem', select the status of the trouble case from one of the possible values: <input type="checkbox"/> Under Review <input type="checkbox"/> Request for Authorization <input type="checkbox"/> Assigned <input type="checkbox"/> Under Investigation <input type="checkbox"/> Pending <input type="checkbox"/> Completed <input type="checkbox"/> Rejected <input type="checkbox"/> Closed <input type="checkbox"/> Cancelled <input type="checkbox"/> All Open <input type="checkbox"/> (Empty) (default value no filter will be applied)
Environment	Select the environment of the trouble case. <input type="checkbox"/> Production <input type="checkbox"/> Customer <input type="checkbox"/> INTEG <input type="checkbox"/> Driving <input type="checkbox"/> Development <input type="checkbox"/> IAC <input type="checkbox"/> EAC <input type="checkbox"/> MIG1 <input type="checkbox"/> MIG2 <input type="checkbox"/> UTEST <input type="checkbox"/> (Empty) (default value no filter will be applied)
Priority	Select the priority of the trouble case. <input type="checkbox"/> 1 – Critical <input type="checkbox"/> 2 – Urgent <input type="checkbox"/> 3 – Medium <input type="checkbox"/> 4 – Low <input type="checkbox"/> (Empty) (default value no filter will be applied)

Customer Type	
Type of Trouble Case*	<p>Select the type of trouble case from the possible values:</p> <ul style="list-style-type: none"> <input type="checkbox"/> Incident (default value) <input type="checkbox"/> Problem <p>Note: Case type = Request is classified as type of trouble case = Incident (further distinction available in the 'Trouble Cases part').</p>
From	<p>Enter the lower bound of the search range for the date and time from which the trouble case is opened or use the <i>calendar</i> icon.</p> <p>Required format is YYYY/MM/DD hh:mm:ss</p> <p>The 'From' date and time must be a valid date earlier than or equal to the current business and earlier than or equal to the 'To' date and time.</p> <p>Reference for error message: [1453]</p> <ul style="list-style-type: none"> <input type="checkbox"/> ARERR10000
To	<p>Enter the upper bound of the search range for the date and time until which the trouble case is opened or use the <i>calendar</i> icon.</p> <p>Required format is: YYYY/MM/DD hh:mm:ss</p> <p>The 'To' date and time must be a valid date later than or equal to the 'From' date and time.</p> <p>Reference for error message: [▶ 1453]</p> <ul style="list-style-type: none"> <input type="checkbox"/> ARERR10000
Customer	<p>Select the party BIC related to your system entity you want to include in your search result.</p> <p>You can select more than one related party BIC.</p>
Trouble Cases	
Trouble Case ID	<p>Shows the alphanumeric number of the trouble case assigned by the system.</p> <p>Note: In case of incidents and requests, the trouble case ID always starts with 'INC'. In case of problems the trouble case ID always starts with 'PBI'.</p>
Environment	<p>Shows the environment chosen for the ticket. Normally it is the environment where the issue was detected.</p>
Priority	<p>Shows the priority assigned to the ticket.</p>

Customer Type	
Open Date	Shows the date and time the trouble case has been opened. Displayed format is: YYYY/MM/DD hh:mm:ss
Description	Shows the description of the trouble case.
Status	Shows the current status of the trouble case. If the type of trouble case is set to 'Incident', this field shows one of the possible values: <ul style="list-style-type: none"> <input type="checkbox"/> Assigned <input type="checkbox"/> In Progress <input type="checkbox"/> Pending <input type="checkbox"/> Resolved <input type="checkbox"/> Closed <input type="checkbox"/> Cancelled <input type="checkbox"/> All Open <input type="checkbox"/> (Empty) (default value no filter will be applied) If the type of trouble case is set to 'Problem', this field shows one of the possible values: <ul style="list-style-type: none"> <input type="checkbox"/> Under Review <input type="checkbox"/> Request for Authorization <input type="checkbox"/> Assigned <input type="checkbox"/> Under Investigation <input type="checkbox"/> Pending <input type="checkbox"/> Completed <input type="checkbox"/> Rejected <input type="checkbox"/> Closed <input type="checkbox"/> Cancelled <input type="checkbox"/> All Open <input type="checkbox"/> (Empty) (default value no filter will be applied)
Status Reason	Shows the reason for the current status of the trouble case. If the status of the trouble case is set to 'Pending', this field shows the reason from the possible values: <ul style="list-style-type: none"> <input type="checkbox"/> Automated Resolution Reported

Customer Type	
	<ul style="list-style-type: none"> <input type="checkbox"/> Client Hold <input type="checkbox"/> Client Action Required <input type="checkbox"/> Support Contact Hold <input type="checkbox"/> Local Site Action Required <input type="checkbox"/> Purchase Order Approval <input type="checkbox"/> Registration Approval <input type="checkbox"/> Supplier Delivery <input type="checkbox"/> Third Party Vendor Action Required <input type="checkbox"/> Infrastructure Change (only if Case Type is set to 'Problem') <input type="checkbox"/> Pending Original Problem (only if Case Type is set to 'Problem') <input type="checkbox"/> Request <input type="checkbox"/> Monitoring Incident <input type="checkbox"/> Monitoring Problem (only if Case Type is set to 'Problem') <input type="checkbox"/> Future Enhancement <p>If the status of the trouble case is set to 'Resolved', this field shows the reason from the possible value:</p> <ul style="list-style-type: none"> <input type="checkbox"/> Automated Resolution Reported <input type="checkbox"/> Customer Follow-Up Required <input type="checkbox"/> Temporary Corrective Action <input type="checkbox"/> Future Enhancement <input type="checkbox"/> Monitoring Incident <input type="checkbox"/> No Further Action Required <p>If the status of the trouble case is set to 'Closed', this field shows the reason from the possible values:</p> <ul style="list-style-type: none"> <input type="checkbox"/> Successful <input type="checkbox"/> Successful with Problem <input type="checkbox"/> Unsuccessful <input type="checkbox"/> (Empty) <p>If the status of the trouble case is set to 'Completed', this field shows the reason from the possible values:</p>

Customer Type	
	<ul style="list-style-type: none"> <input type="checkbox"/> Known Error <input type="checkbox"/> Solution Database <input type="checkbox"/> Enhancement Request <input type="checkbox"/> Unresolvable <p>If the status of the trouble case is set to 'Cancelled', this field shows the reason from the possible values:</p> <ul style="list-style-type: none"> <input type="checkbox"/> No longer a Causal CI (only in case of incident/request Ticket) <input type="checkbox"/> Duplicate Investigation (only if case type is set to 'Problem') <input type="checkbox"/> Not a Defect (only in case of problem tickets) <input type="checkbox"/> (Empty) <p>This field is only filled in if the status of the trouble case is equal to 'Pending', 'Resolved' or 'Completed' or if the status is equal to 'Closed' or 'Cancelled' and the status reason has been indicated during data acquisition.</p>
Customer Trouble Case ID	Shows the internal identifier reported by the Customer it-self when opening the ticket
Public Trouble Case	Shows whether the trouble case is public, i.e. only visible to the related system entity of the party BIC, or visible to all parties from the possible values: <ul style="list-style-type: none"> <input type="checkbox"/> Yes <input type="checkbox"/> Broadcast
Party BIC	It shows the party BIC of the system entity for which the ticket was opened.

Buttons

All available buttons in this screen are related to your browser used and therefore not described in this chapter.

4.3 User Instructions Part

4.3.1 Monitoring of a Trouble Case

Overview

This business package describes the monitoring of a trouble case. To monitor a trouble case, carry out the business scenarios relevant to you from the list below.

Business Scenarios

- View trouble case [▶ 862]
- Execute a report [▶ 862]

4.3.1.1 View Trouble Case

Context of Usage	This business scenario describes how to view trouble cases related to your system entity, trouble cases opened upon request of parties related to your system entity and in addition trouble cases of general importance visible to all parties. Viewing a trouble case is one option of monitoring of a trouble case.
References	Further information on screens involved can be found in the screen reference part: <ul style="list-style-type: none"><input type="checkbox"/> <i>Trouble case – search/list</i> screen [▶ 843]<input type="checkbox"/> <i>Trouble case – details</i> screen [▶ 849]
Instructions	<ol style="list-style-type: none">1. Go to the <i>trouble case – search/list</i> screen.2. Depending on your system entity you will see a list of available parties (system entity and party BIC) to be included in your search. Select at least 1 of the displayed Party BICs.3. Enter all search criteria known to you about the trouble case you want to view.4. Click on the <i>search</i> button.<ul style="list-style-type: none">⇒ A list containing the search results is displayed on the screen.5. Select the trouble case you would like to display in detail.6. Click on the <i>details</i> button.<ul style="list-style-type: none">➔ The details of the selected ticket are displayed.

4.3.1.2 Execute a Report

Context of Usage	This business scenario describes how to execute and export or print a report on trouble cases related to your system entity, trouble cases opened by parties related to your system entity and in addition trouble cases broadcasted to all parties. <p>Executing a report is 1 option of monitoring of trouble cases.</p>
Privileges	To carry out this business scenario, you need the following privilege: <ul style="list-style-type: none"><input type="checkbox"/> TMS Access
References	Further information on screens involved can be found in the screen reference part: <ul style="list-style-type: none"><input type="checkbox"/> <i>Trouble case – search/list</i> screen [▶ 843]<input type="checkbox"/> <i>Trouble case – export</i> screen [▶ 855]
Instructions	<ol style="list-style-type: none">1. Go to the <i>trouble case – search/list</i> screen.2. Click on the <i>search</i> button.



Hint

You can also restrict your search results by inputting the relevant search parameters.

⇒ A list containing the search results is displayed on the bottom part of the screen.

3. Select the trouble cases to be included in your report (clicking on each of the 'column name fields' allows ordering the list in ascending or descending order for the selected column).



Alternative action

Click on the *select all* button to include all trouble cases from the list.

4. Click on the *export* button.

⇒ The *trouble case - export* screen is displayed.



Note

Depending on your browser used and local settings the buttons to be used to export or print a report and the further steps may differ. In the following example Mozilla Firefox has been used.

5. Click on the *export report* button.



⇒ The export report window of your browser is opened.

6. Select the export format and in case of need the pages of the report to be exported. Possible format are: PDF, Power Point, Word, Post Script and Excel.

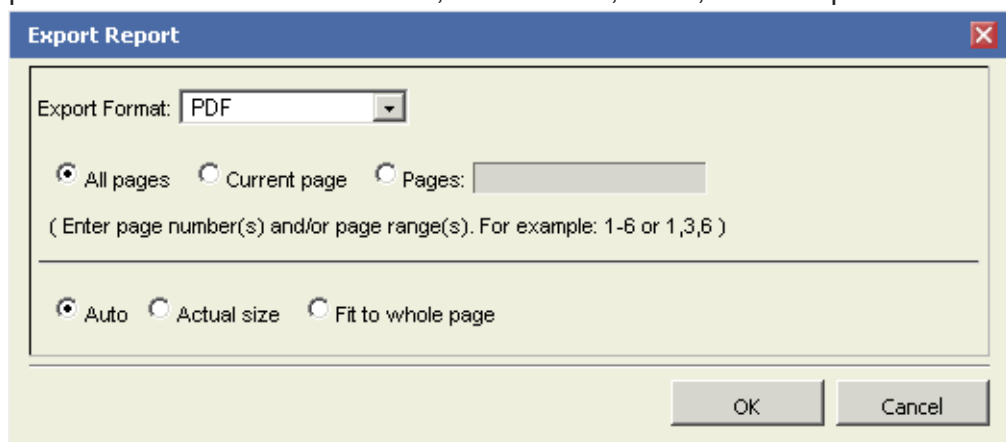

7. Click on the *ok* button.

⇒ The standard download window of your browser is opened.

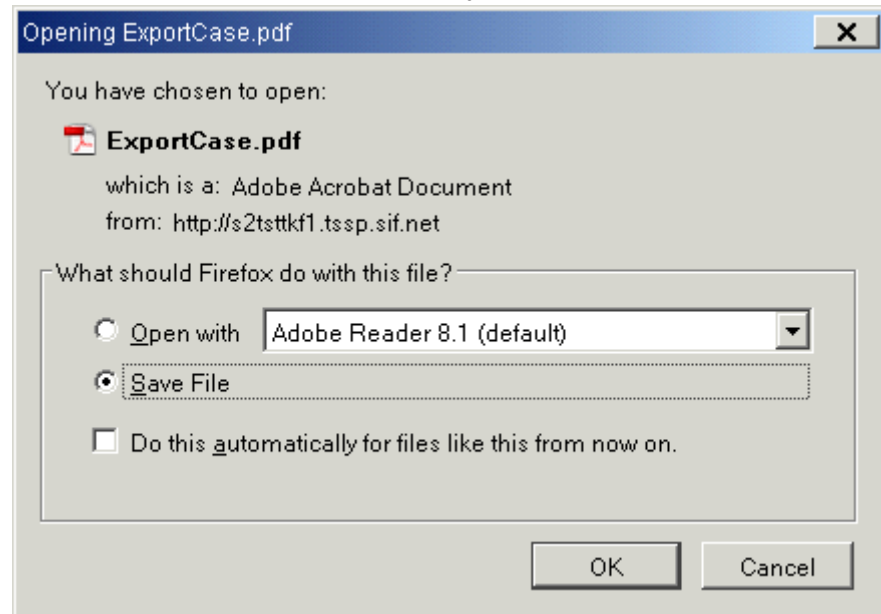

8. Click on the **OK** button.

➔ The report is downloaded and saved in the standard download folder of your browser.

5 Statistical Information Part

5.1 Introduction

5.1.1 Purpose of the document

Aim

The Data Warehouse (DWH) User Handbook, hereinafter referred to as UHB, aims to facilitate the use of the Data Warehouse Graphical User Interface. It is addressed to all DWH users, regardless of the parties and describes the full range of functionalities available in user-to-application (U2A) mode. The UHB provides detailed reference information on all GUI functionalities and step-by-step descriptions. Thus the DWH UHB provides helpful information on the use of the DWH GUI.

Actors

There is only one handbook for DWH addressing all actors: Central Banks (CB), Payment Banks (PB) and Ancillary Systems (AS). Specific chapters for CB users with advanced user's profile (see chapter Overview [▶ 867]) are marked with the annex "for advanced user" in the title of the chapter. All other chapters are relevant for each reader. ¹⁹

5.1.1.1 UHB Methodology

To ease orientation and help you to find your desired information quickly several symbols and methodological elements are used throughout the DWH UHB.

Page

Every page of the UHB has a similar page layout. You can find the following elements:

- The header, which shows the chapter and the sub-chapter title,**
- The text, which contains the main information, tables and screenshots**
- The footer, which shows page number and the amount of pages of the document**

Links

Links are illustrated throughout the UHB with a little triangle followed by a page number within squared brackets. These links help you to jump to related sections by clicking on them or turning to the relevant page.

Example: [▶ 209]

19 This content is not applicable as of R6.2, and will become applicable upon the deployment of the Data Warehouse for T2S.

Tables

Tables are used to present information in a clearly arranged format. They consist of a table head and a table body. The body is divided into a left and a right column. The left column contains keywords, for example field names, which are explained in the right column. Subsections within a table are preceded by a heading. The order of the description follows the appearance on the screens from left to right and from top to bottom.

Action steps

Step-by-step descriptions are divided into single action steps. These steps are numbered sequentially. Intermediate results are described where appropriate.

Screenshots

Screenshots are used to illustrate the corresponding text. Note that there might be minor deviations between the screenshot and your screen appearance, according to your access rights or a specific selection you have made. In addition, some functions are mutually exclusive and cannot be represented in a single screen-shot. In these cases, the screenshot illustrates the more relevant use of the screen.

Values shown on a screenshot might also deviate from the default values indicated in the description. In these cases, the description is valid rather than the screenshot.{CR-819}

5.1.1.2 UHB Structure

The UHB is divided in eight chapters:

- | | |
|------------------|--|
| Chapter 1 | The chapter Introduction explains the aim, the content and the approach of both the UHB and the DWH GUI. While the first section explains how to use the UHB, the second section focuses on technical requirements. |
| Chapter 2 | The chapter Introduction to the Data Warehouse provides background information about the Data Warehouse itself and also about the software tool used as GUI. |
| Chapter 3 | The chapter First steps & basics provides the reader with basic elements and the structure of the DWH GUI. |
| Chapter 4 | The chapter Working with reports explains the reader how to <ul style="list-style-type: none"><input type="checkbox"/> copy and save a report (see chapter Copy, save and export [▶ 925])<input type="checkbox"/> run a report (see chapter Running reports [▶ 935])<input type="checkbox"/> schedule a report (see chapter Scheduling reports [▶ 953]) |
| Chapter 5 | The chapter Predefined reports provides the reader with information about all predefined reports. |

5.1.2 Set-up and Login

5.1.2.1 GUI Access

Users are directed to an initial page named ESMIG portal that ensures proper routing to the web applications the user has been granted to enter. Refer to the Connectivity Guide specified in the ESMIG UDFS document, current version available, for details on the communication network and services. ²⁰

5.1.2.2 Technical Requirements

Before entering the GUI, make sure to implement all necessary preparations described below.

Such preparations may be subject to periodical review/update to comply with changing technical/regulatory scenarios.

Supported Web- Browsers

Please refer to ESMIG qualified configurations document annexed to the ESMIG UDFS. ²¹

The required minimum screen resolution is 1366 x 768 pixel. Screen resolutions below this requirement are not supported and can lead to a deviating appearance and functionality of the GUI.

Even if the screen resolution fulfils the requirement defined above, it is important to note that scaling options provided by the operating system and the browser (e.g. 125% or 150%) may cause a deviating appearance and functionality of the GUI. If this is the case, the usage of scaling options is not supported.{CR-819}

5.2 Introduction to the Data Warehouse

5.2.1 Overview

Context of Usage

The aim of the DWH is to store and compile information coming from TARGET2-Securities (T2S) and common components i.e. Common Reference Data Management (CRDM), Billing (BILL) and Business Day Management (BDM) in a homogenous manner at business level.

20 This content is not applicable as of R6.2, and will become applicable upon the deployment of the Data Warehouse for T2S.

21 This content is not applicable as of R6.2, and will become applicable upon the deployment of the Data Warehouse for T2S.

The DWH provides access to data in U2A mode and permits access to data within the databases. It gives a business-oriented view of the collected data without any detailed technical database terminology. Therefore, no knowledge about the database structure of T2S is required. It provides information through reports as predefined reports.

Parties

The DWH consolidates the content of the sources into a single database for reporting purposes and offers pre-defined reports to the users of the following T2S parties:

- Central Banks (CB),
- Central Securities Depositories (CSD)
- External CSDs (eCSD),**
- Payment Banks (PB).{CR-819}**

Access Rights

The precondition for a user to obtain access to the DWH is a setup in CRDM by the respective party. Access to the DWH depends on the user's profile, which ensures that the user is allowed to perform the requested action(s). There are two user profiles reflected as privileges in CRDM:

- Normal user profile: will be available for **all party types CB/CSD users only. {CR-819}**
- Advanced user profile: will be available for CB/CSD users only.

The data scope in the DWH follows the following rules:

- Users have access to their parties' data based on the data scope according to the hierarchical model (for details please refer to CRDM UDFS).
- For CBs/CSDs: Each CB/CSD has access to granular data for all parties belonging to its system entity. Moreover, each CB/CSD has access to aggregated data of all system entities.

DWH platform

The DWH uses Cognos as platform. It is an enterprise wide Business Intelligence (BI) solution, mostly used for reporting. Cognos is a web-based solution. Both the development and the end user interface are displayed on the web. It supports Relational Online Analytical Processing (ROLAP) and Multidimensional Online Analytical Processing (MOLAP) data sources.

A2A & U2A mode

The DWH provides reports to users in different formats in user-to-application mode (U2A) or to other applications in application-to-application mode (A2A). The user can run a report directly in the DWH GUI (Cognos) and export the result. The second option is A2A delivery of the report as a file. To achieve this, the report has to be scheduled as described in chapter Scheduling reports [► 953].

Note: A CB user with advanced user profile was used in order to show the full scope of all screenshot pictures presented in this document. ²²

5.2.2 Process of the Data Warehouse

DWH layers

DWH receives data from different services and common components and processes the data in order to make them available via reports and files. The data passes through the following three layers:

1. landing zone,
2. core layer,
3. enterprise layer.

The data are transmitted into the landing zone of the DWH as a copy after the end of each business day (EoD). The landing zone buffers the data before they are selected and loaded into the core layer.

The core layer stores only granular, validated, harmonised and historicised data.

From the core layer the data are loaded into the enterprise layer. In the enterprise layer the data are aggregated, calculated and prepared for reporting and analysis in a dimensional structure.

The stored data cannot be retrieved in the landing zone; instead, detailed structured and aggregated data can be accessed through the reports. The reports are built using the data in the core and the enterprise layer.

After processing (data transformation and pre-calculations) of the transmitted data within the DWH, data from the previous business day are available in the DWH at the start of the new calendar day at the latest.

Diagram

The following diagram provides a high-level overview of the flow from the source through the different DWH layers: ²³

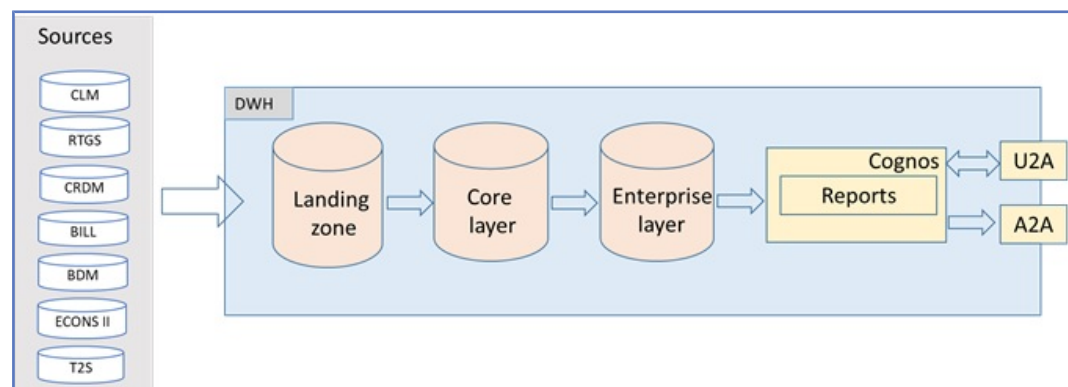

Illustration 146: DWH high level overview ²³

²² This content is not applicable as of R6.2, and will become applicable upon the deployment of the Data Warehouse for T2S.

²³ This content is not applicable as of R6.2, and will become applicable upon the deployment of the Data Warehouse for T2S.

5.3 First steps & basics

5.3.1 Access to the DWH

Access to the DWH is managed through the Eurosystem Single Market Infrastructure Gateway (ESMIG). ESMIG provides to the DWH specific credentials found in CRDM for a specific user-id. This ensures that you have access to the relevant information depending on the party you belong to, the party type and your privilege.²⁴

As soon as your login is successful for the first time, you will see the welcome page.

The welcome page provides quick access to the product functionalities and content.{CR-819}

Welcome Page

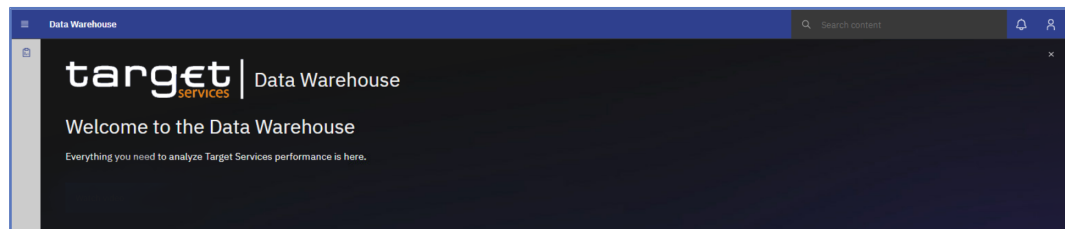



Illustration 147: **Welcome page**²⁵{CR-819}

The welcome page consists of the following building blocks:

Global application bar

The global application bar (the blue bar at the top of the screen) is a constant element of the user interface.

When the welcome page is open, the following, standard options are available:

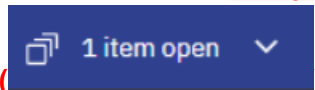
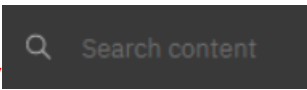
- “Open menu” icon** ()
- “Data Warehouse” home page link** ()
- “View switcher” - only visible if at least one document is open** ()
- “Search content”** ()

24 For details on the network communication and services, refer to the Connectivity Guide specified in the ESMIG UDFS.

25 This content is not applicable as of R6.2, and will become applicable upon the deployment of the Data Warehouse for T2S.

□ **“Notifications” icon** ()

□ **“Personal menu” icon** ()

Welcome banner

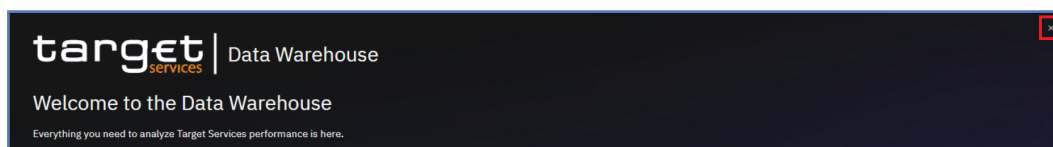



Illustration 148: **Welcome banner**{CR-819}

You can hide the banner by clicking the “Close” icon () **or you can go to the personal menu, and under “Profile and settings > Settings”, toggle the “Welcome banner” switch on or off.**{CR-819}

5.3.2 Navigating in the DWH GUI – toolbar Global application bar

5.3.2.1 Open Menu

The “Open menu” is the main access point to the Cognos Analytics.

Click the “Open menu” icon () **you return to the “Welcome” page.**
{CR-819}

5.3.2.2 Welcome menu

In the following example, you open a report and a report view. The “Welcome” menu provides the ability to view the reports and the “Welcome” page.

By clicking on the report or the report view, you can switch between the report and the report view.{CR-819}

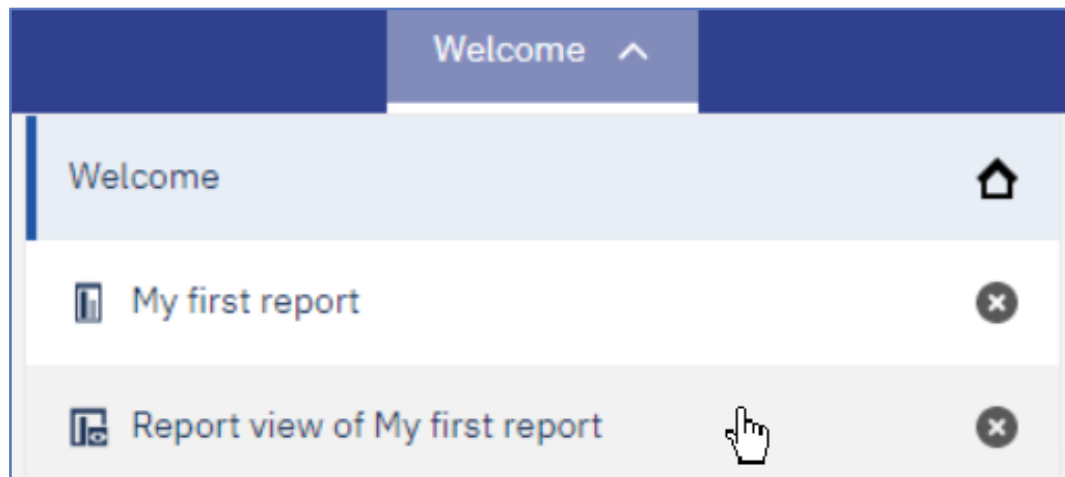



Illustration 149: Welcome page – navigation view – items – report view selection ²⁶{CR-819}

5.3.2.3 Data Warehouse icon

By clicking on the “Data Warehouse” icon () you return to the “Welcome” page.{CR-819}

5.3.2.4 Navigate between different views View Switcher

In the DWH GUI different pages each containing another report can be open at the same time. ~~The Welcome menu allows to switch from one page to another. In case you run more than one report the “Welcome” menu in the middle of the tool~~ The “View switcher” in the application bar provides a convenient way to navigate among them between open views, and closes the views when they are no longer needed. You can navigate between different types of items, such as folders, reports, schedules, and more, from this view.

Tool Bar



Illustration 150: Welcome page - navigation view{CR-819}

Position No.	Description
1	Welcome menu
2	More icon
3	Notification icon

26 **This content is not applicable as of R6.2, and will become applicable upon the deployment of the Data Warehouse for T2S.** {CR-819}

Position No.	Description
4	Personal menu
5	Help-menu ²⁷ {CR-819}

In the following example, you open a report and a report view. The “View switcher” provides the ability to view both of the objects:

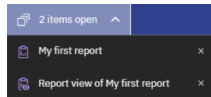

Illustration 151: Welcome page - navigation view - items{CR-819}

By clicking on the report or the report view, you can switch between the report and the report view:{CR-819}

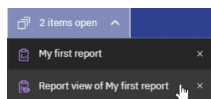

Illustration 152: Welcome page – navigation view – items – report view selection{CR-819}

5.3.2.5 More icon

With the “More” icon you can set any page of your choice as your welcome page.

If you view saved output and you want to know when there is a new version of the report, you can tap the “Notify me” icon.

“Notify” Icon

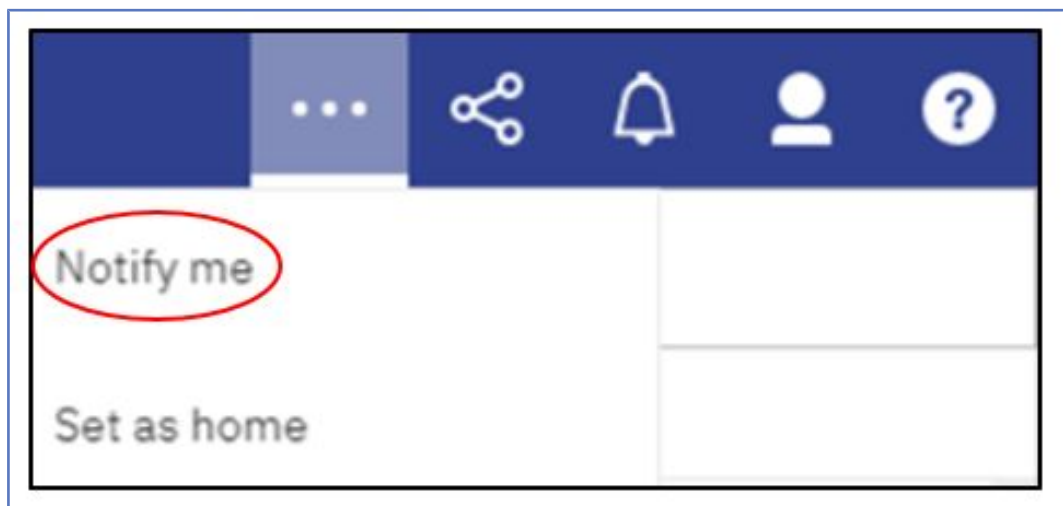

27 **This content is not applicable as of R6.2, and will become applicable upon the deployment of the Data Warehouse for T2S.** {CR-819}

“Set as Home” Icon

To change the welcome page you navigate to the page you want to specify as welcome page and click on the “More” icon and select “Set as home”. Next time you log in to the DWH you will directly enter to your selected personal welcome page. ²⁶{CR-819}

5.3.2.6 Set Notifications

Under the “Notification” icon you can find system messages and the result of executed reports.

If you scheduled a report or are running a report in background that shall be saved in the DWH you are notified every time the result is available.

“Notification” Items

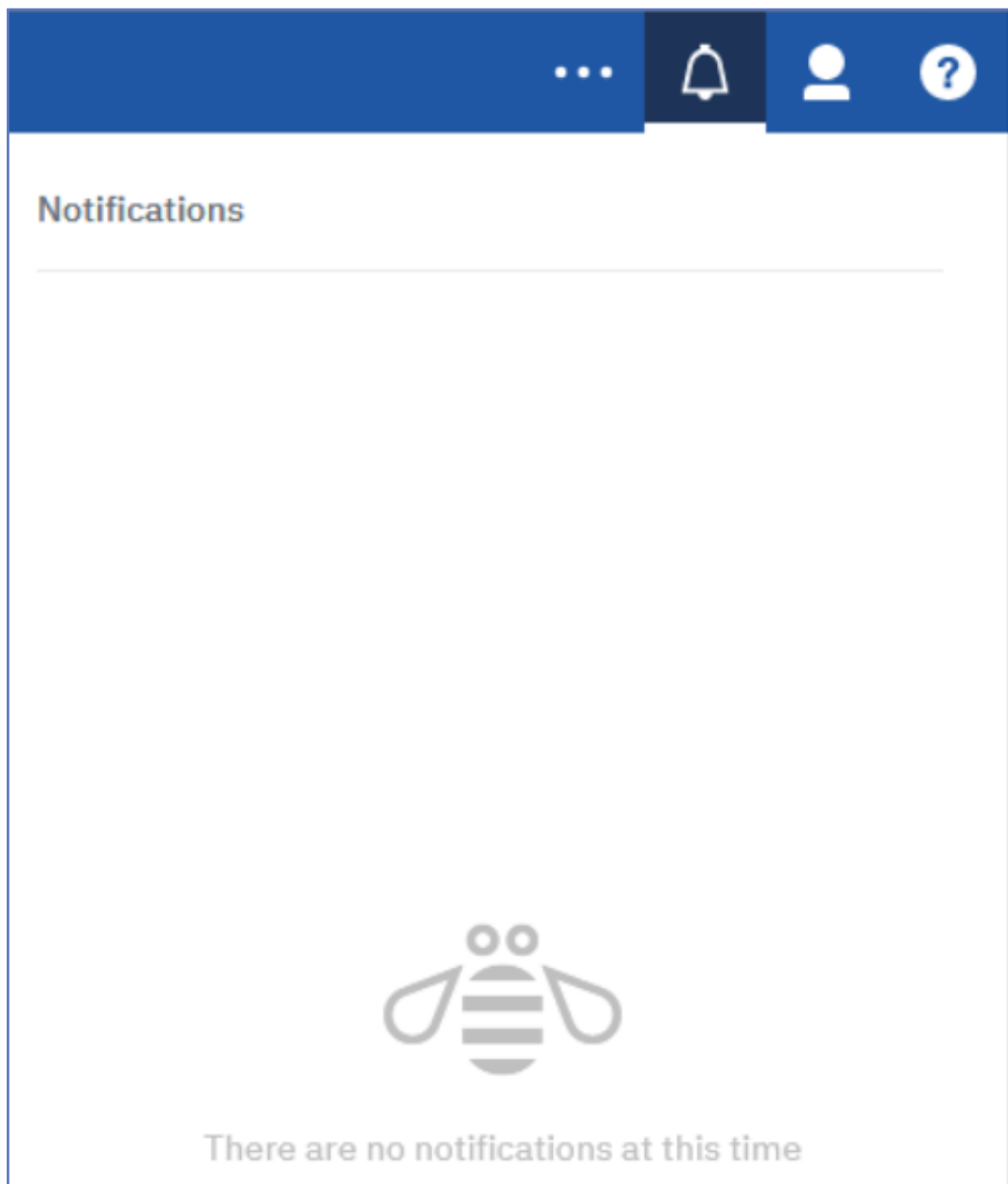

Illustration 153: **Welcome page – Notification – notification items**{CR-819}

Example

The process of Notifications can be explained in the following example:

1. **Create a Report view:**

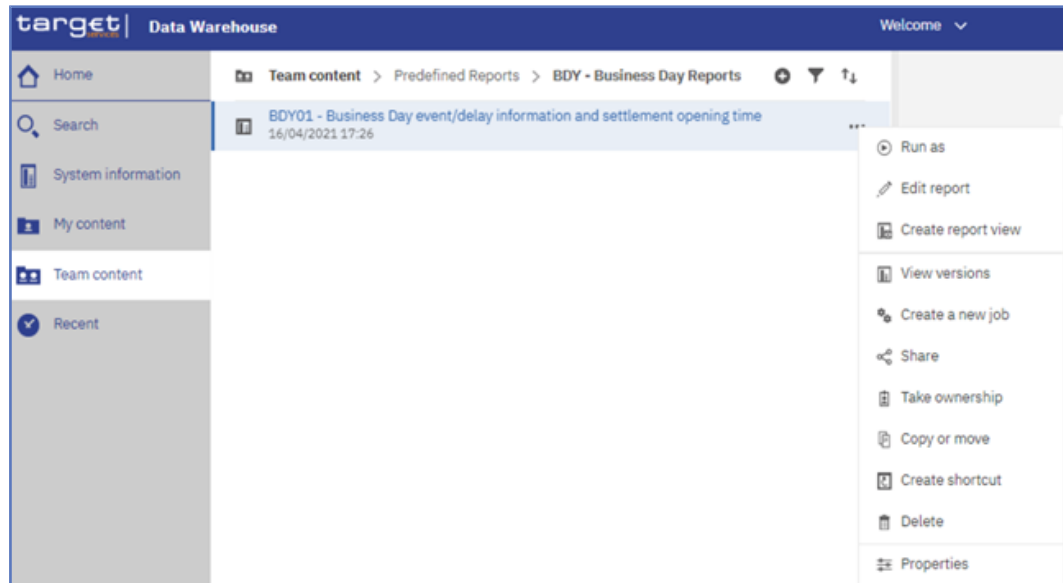

Illustration 154: **New report version – Notify me creation – Create a Report view**{CR-819}

2. **Save it in a file under “My content”:**

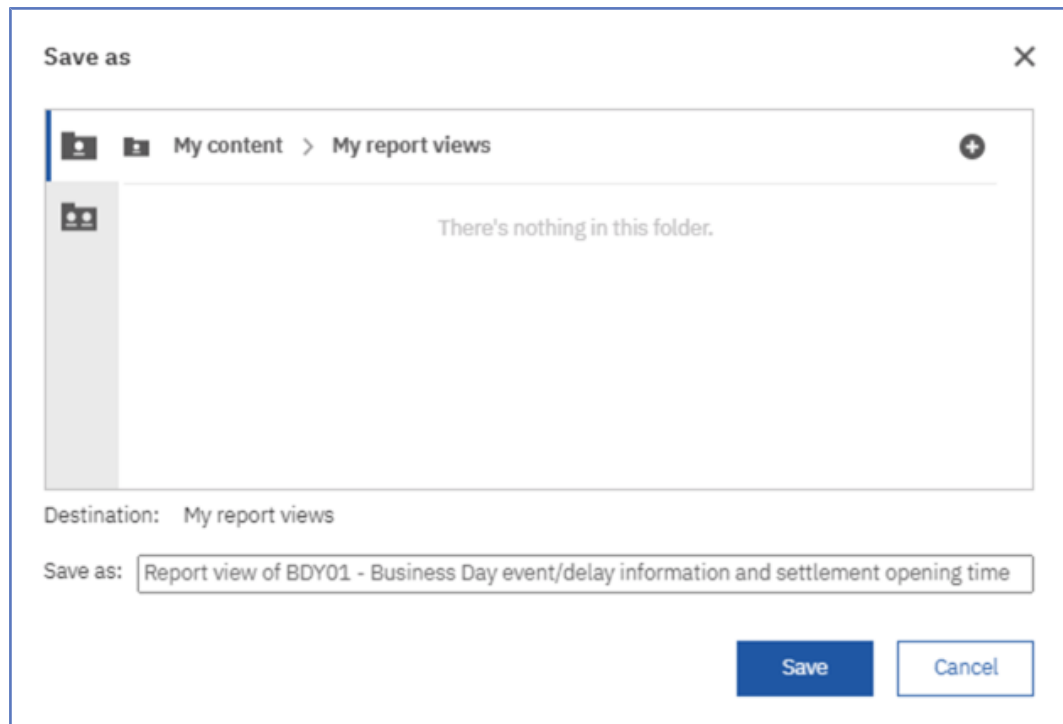

Illustration 155: **New report version – Notify me creation – Save Report view in “My content”**{CR-819}

3. **Click on the tree dots to the right of the report view to view the properties of the report:**

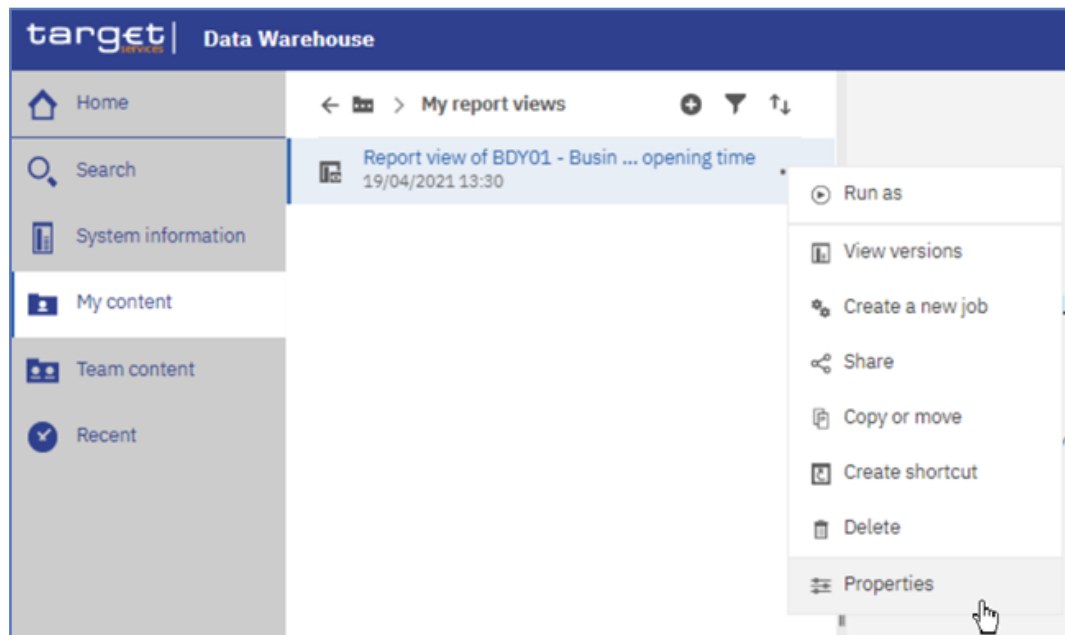

Illustration 156: **New report version – Notify me creation – Report view properties**(CR-819)

4. **Create a schedule by clicking on the “Schedule” tab:**

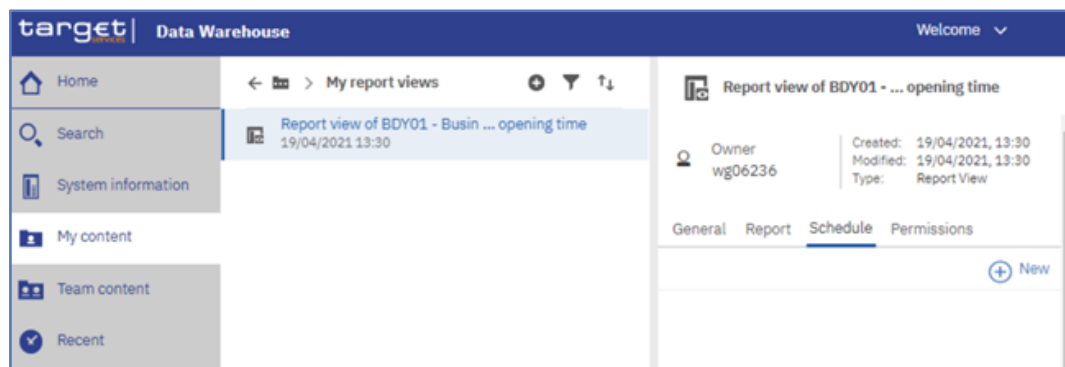

Illustration 157: **New report version – Notify me creation – Report view – Create Schedule**(CR-819)

5. **Click on “New” to create a schedule:**

< Back **Create schedule**

Schedule Weekly

Period

Start 2021-04-19 13:36

End 2021-07-19 13:36

No end date

Run every 1 week(s)

On day(s) M T W T F S S

Daily time interval

Options

Format HTML >

Delivery Save >

Prompts Set values >

Languages English (United Kingdom) >

PDF Select

Illustration 158: ~~New report version – Notify me creation – Report view – Create schedule settings~~{CR-819}

6. Click on “Set values” and “Set” to enter prompt values:

Illustration 159: **New report version – Notify me creation – Report view – Create schedule – Set values**{CR-819}

7. **In the pop-up window enter the desired values and click on “Finish”:**

Illustration 160: **New report version – Notify me creation – Report view – Create schedule – prompt values**{CR-819}

8. **Set the “Start” and “End” of the schedule and click on “Create” to create the schedule:**

The screenshot shows a mobile application interface for creating a schedule. The title is "Create schedule". The "Schedule" is set to "Weekly". The "Period" section includes "Start" (2021-04-19 13:41) and "End" (2021-07-19 13:36) fields, with a "No end date" checkbox. The "Run every" field is set to "1 week(s)". The "On day(s)" field shows a calendar grid with "M" selected. There is a "Daily time interval" checkbox. The "Options" section includes "Format" (HTML), "Delivery" (Save), "Prompts" (4 schedule prompt values), and "Languages" (English (United Kingdom)). There is a "PDF" option with a "Select" button. At the bottom, there are "Create" and "Cancel" buttons.

Illustration 161: **New report version – Notify me creation – Report view – Create schedule – Start and End period (CR-819)**

9. **Click on the tree dots to the right of the report view to view the menu, and click on “View versions”:**

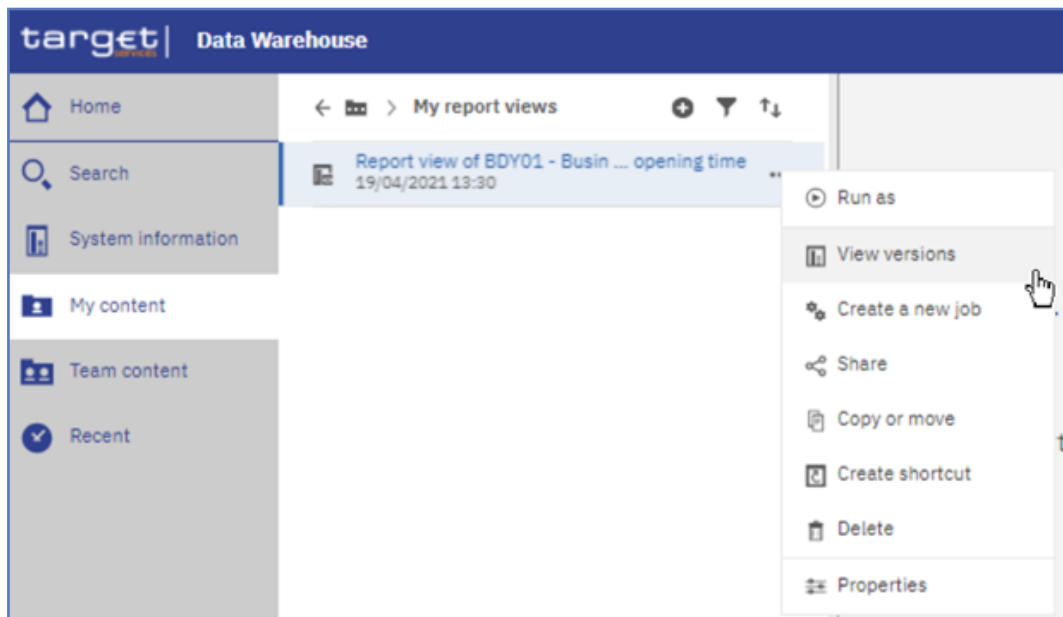

Illustration 162: **New report version – Notify me creation – Report view – View versions**{CR-819}

10. **Click on the date of the report view run and click on the HTML icon to view the result:**

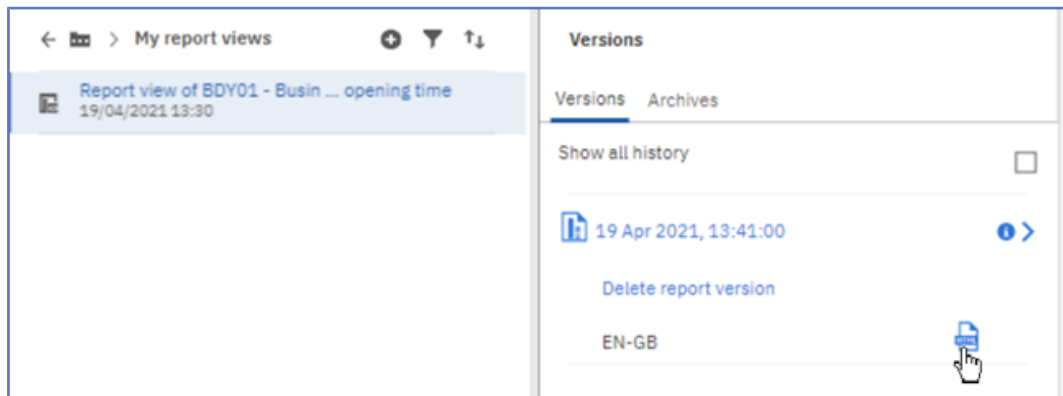

Illustration 163: **New report version – Notify me creation – Report view – Versions**{CR-819}

11. **Click on the three dots to right of the blue ribbon to view the “Notify me” icon:**

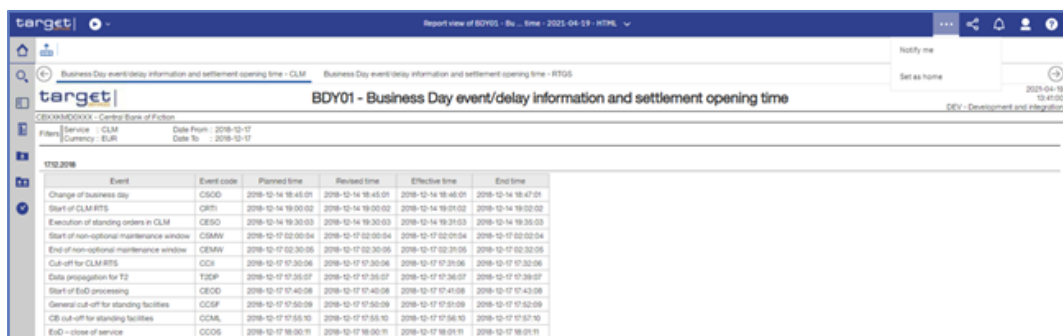

Illustration 164: **New report version – Notify me creation – Report view – Three dots – Notify me**{CR-819}

➔ **By clicking on the “Notify me”, you will be presented with a message of your notification on the event of a future change:{CR-819}**

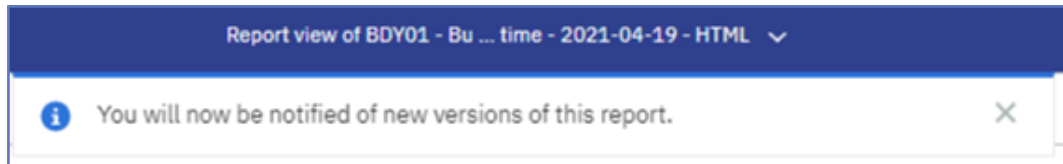

Illustration 165: **New report version – Notify me creation – Report view – Notify me enabled**
29{CR-819}

5.3.2.7 Search content

Search content is a quick and easy way to find content in Cognos.

You can search for items such as reports, folders etc. You can also search for ta-ble or column labels, XML report specifications, shortcuts, templates, and more.

Search content does not return results for content that is archived, but you can access archived content from any report that is listed in one of your folders.

The search content box is located in the application bar, as shown in the following screen capture:

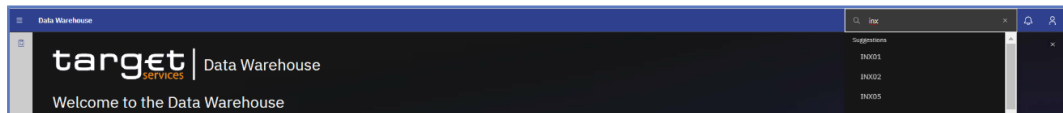



Illustration 166: **Welcome page – Search content**{CR-819}

To find items, type the search terms (keywords, phrases, strings), and click the Enter key. After the search results are listed, you can save your search

by clicking the “Save search” button (). If your search returns too many results, you can click the “filter” icon (), and select the options that you want. The filter option is only available after you do an initial search. The filters are saved with the search.

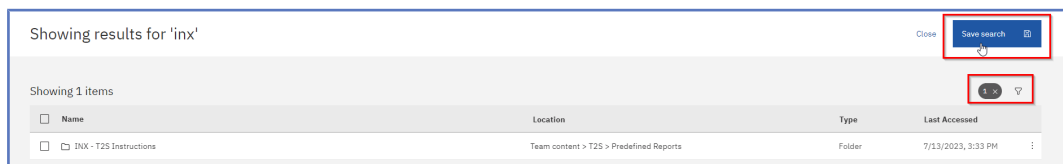

Illustration 167: **Welcome page – Search content - Save search**{CR-819}

29 **This content is not applicable as of R6.2, and will become applicable upon the deployment of the Data Warehouse for T2S.**
{CR-819}

From the search results page, you can initiate actions on the returned items. If you select multiple items (by clicking their check boxes), the related actions that are available for all or at least one item are shown in the toolbar, above the search results.

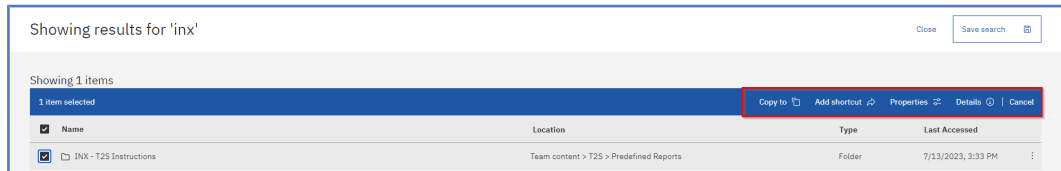

Illustration 168: Welcome page – Search content - initiate actions{CR-819}

To view the actions for a specific item, select the checkbox for this item (all other items must be deselected), and click its “Action menu” (⋮) icon. The actions that are available for the selected item are shown. For example, the following screen capture shows actions for a report.

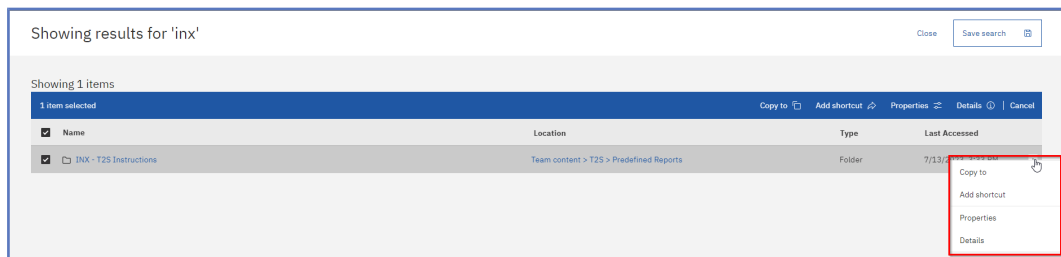

Illustration 169: Welcome page – Search content - Action menu{CR-819}

Special characters and search in double quotation marks

You can use the following special characters in your search terms:

”~!@#%\$%^&*()-+={|}||:;<.>./”

When you enclose your search terms in double quotation marks (" "), the search results include only those instances where the terms appear in the exact order as within the double quotation marks.{CR-819}

5.3.2.8 Notification

Notifications help you stay on top of important data.

If you view a saved output and you want to know when there is a new version of the report, you can click the “Notify me” button. A saved output is either a report view in html format or the html view of the report when the option “Run in back-ground” is selected. If you choose to be notified when a new version is available, you are notified every time t a new version of the report is delivered.

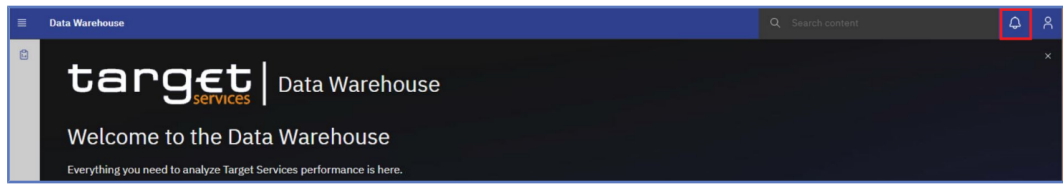

Illustration 170: Welcome page - Notification{CR-819}

The Notify me option is available in view mode of an html output of a report or a report view when it is saved in “My content” folder when you tap the “More” button in the application bar.

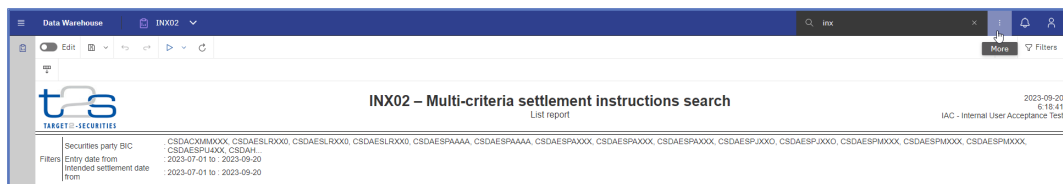

Illustration 171: More options – Notify me{CR-819}

If you request notification and then someone runs that report, you get a notification with a link to the updated version.

When you subscribe, if you choose the “Save the report on the system” delivery option, you receive a notification with a link to the new report version.

To see all your notifications, tap the “Notifications” icon



in the ap-

bar. When you receive a new notification, a number is added to the icon



5.3.2.8.1 Subscribing to reports

When you subscribe to reports, you pick the time, date, format, and where you want it delivered. When you subscribe to a report, the subscription includes all your prompt and parameter values.

The subscription option is available in the application bar when you run and view a report, but not when you are in editing mode or when you view saved output.

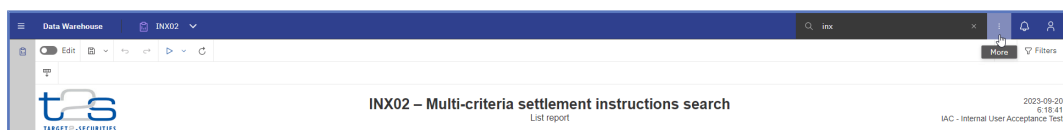

Illustration 172: Welcome page - Notification – subscribe{CR-819}

Note for users with advanced user profile:

To ensure that you are in view mode, and not in edit mode, turn off the

“Edit” toggle ().

If you edit a report, you must save it before you can subscribe.

After you subscribe, each time your report is delivered, you are notified by a red circle on the

“Notifications” icon () in the application bar.

The number in the red circle indicates the number of notifications that you have not yet viewed. Tap the notifications icon to find a message with a link to view the report output.

After you create your subscriptions, you can view and manage them. For more information, see chapter [Scheduling reports](#) [▶ 953].{CR-819}

5.3.2.9 Personal menu

In the **“Personal menu”** icon you can find settings to customise your DWH experience.

You can view and edit your personal and regional information, monitor the system activities etc. The user can edit the time zone, the product language and view the capabilities granted by the administrator. For further information, [please](#) refer to chapter [My preferences](#) [▶ 887]. ³⁰{CR-819}

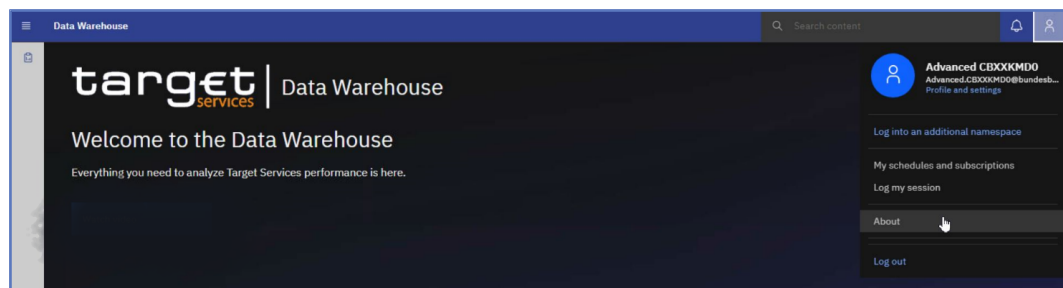

Illustration 173: **Welcome screen – Personal menu (1)**{CR-819}

30 **This content is not applicable as of R6.2, and will become applicable upon the deployment of the Data Warehouse for T2S.** {CR-819}

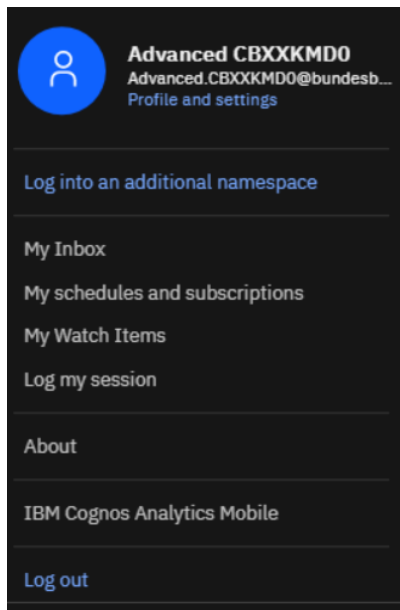

Illustration 174: Welcome screen – Personal menu (2){CR-819}

5.3.2.9.1 Profile and Settings

In the “Profile and settings” menu you can find more information about your user under “Profile”. Please note, that some of the settings displayed have to be changed in CRDM e.g. User information, granted privilege.

For example you will see your email address if available in CRDM.

You can also find information about “Groups and roles” and “My capabilities” described in detail hereafter.

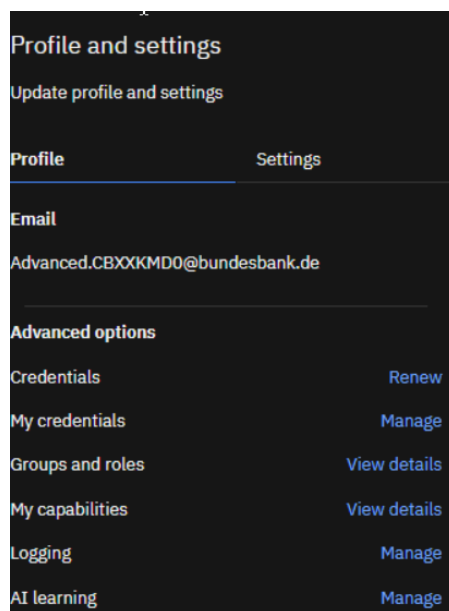

Illustration 175: Welcome screen – Personal menu – Profile and settings – Profile{CR-819}

Groups and roles

You can find the groups and roles you are associated to by clicking on “View details” at the right of “Groups and roles”. Please refer to [Understanding user rights and access rights \(advanced users\)](#) to find more information about groups and roles.

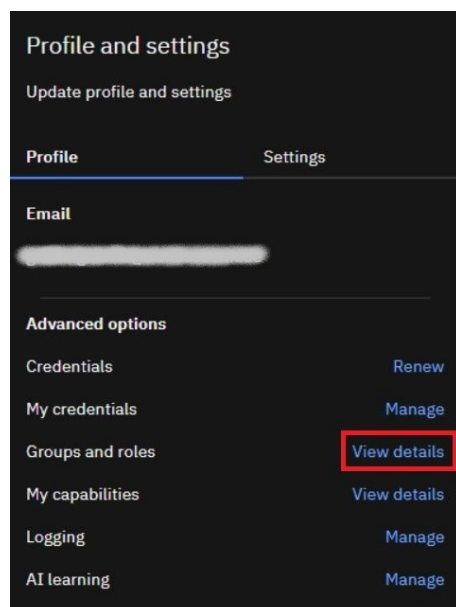

Illustration 176: Welcome screen – Personal menu – Profile and settings – Personal – Groups and roles{CR-819}

My capabilities

The capabilities control access to different administration tasks and different functional areas of the user interface in DWH. You can find the capabilities assigned to you by clicking on “View details” on the right of the section.{CR-819}

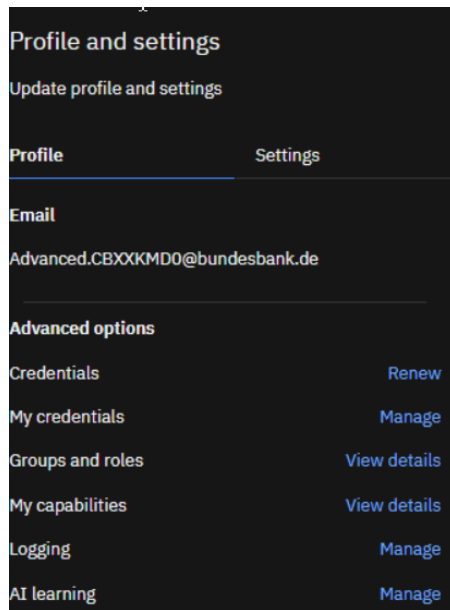

Illustration 177: Welcome screen – Personal menu – Profile and settings – Profile – My capabilities (1){CR-819}

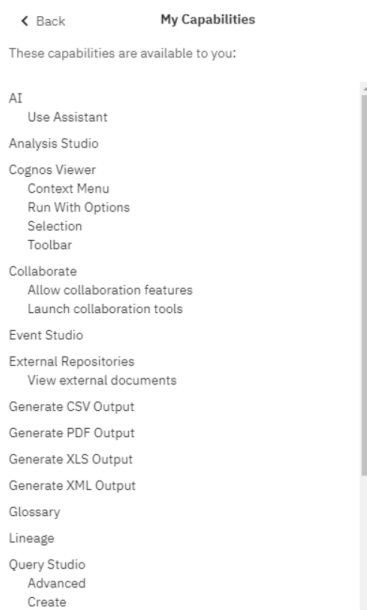

Illustration 178: Welcome screen – Personal menu – Profile and settings – Profile – My capabilities (2){CR-819}

5.3.2.9.2 My preferences

The chapter “My preferences” is divided in two chapters. One describes the preferences under general the second explains the preferences under personal. ³¹{CR-819}

31 **This content is not applicable as of R6.2, and will become applicable upon the deployment of the Data Warehouse for T2S.** {CR-819}

5.3.2.9.2.1 My preferences – general

~~You can set up preferences for your DWH applications. To set your preferences in the personal menu click on “My preferences”.~~

My preferences

General Personal

Home page Default

Report format HTML

Turn on accessibility features

Show hints

Options for your region

Time zone (GMT+01:00) Germany Time >

Product language English >

Content language English (United Kingdom) >

Bidirectional language support

Base direction for text Right-to-left

Illustration 179: ~~Welcome screen – Personal menu – My preferences~~(CR-819)

~~In case a different page than the default is set, the user can reset to the default.~~

Report Format ~~The default value for the report format is html.~~

~~But you can choose also one of the following formats:~~

- ~~Excel (same content as html but as Excel file)~~
- ~~Excel Data (only the report data is exported – Not recommended since it does not work properly)~~
- ~~Pdf~~
- ~~Html~~
- ~~Csv~~
- ~~Xml~~

~~Accessibility Features~~

~~Accessibility features assist users who have a disability, such as restricted mobility or limited vision, to use information technology content successfully.~~

~~Show Hints~~

~~When you first sign in to the DWH, you can see hints that help you navigate through the user interface. If you turn the hints off, but want to show them again, select the “Show hints” check box.~~

~~Language Settings~~

~~The default language is English.~~

~~You can select the language that you prefer for the DWH user interface. If your data and reports are available in multiple languages, you can also select the language that you prefer for the content. There is also support for bidirectional languages such as Hebrew, Arabic, Urdu, and Farsi. Report authors can control the display of native digits and the direction of text, crosstabs, and charts. ³²{CR-819}~~

5.3.2.9.2.2 My preferences – Personal

In the “My preferences” menu you can find more information about yourself under “Personal”. (Note: Some of the settings displayed have to be changed in CRDM e.g. User information, granted privilege.)

You will see your email if available in CRDM, and with a click on the arrow next to “Advanced”, further information are shown.

You can also find information about “Groups and roles” and “My capabilities” described in detail hereafter.

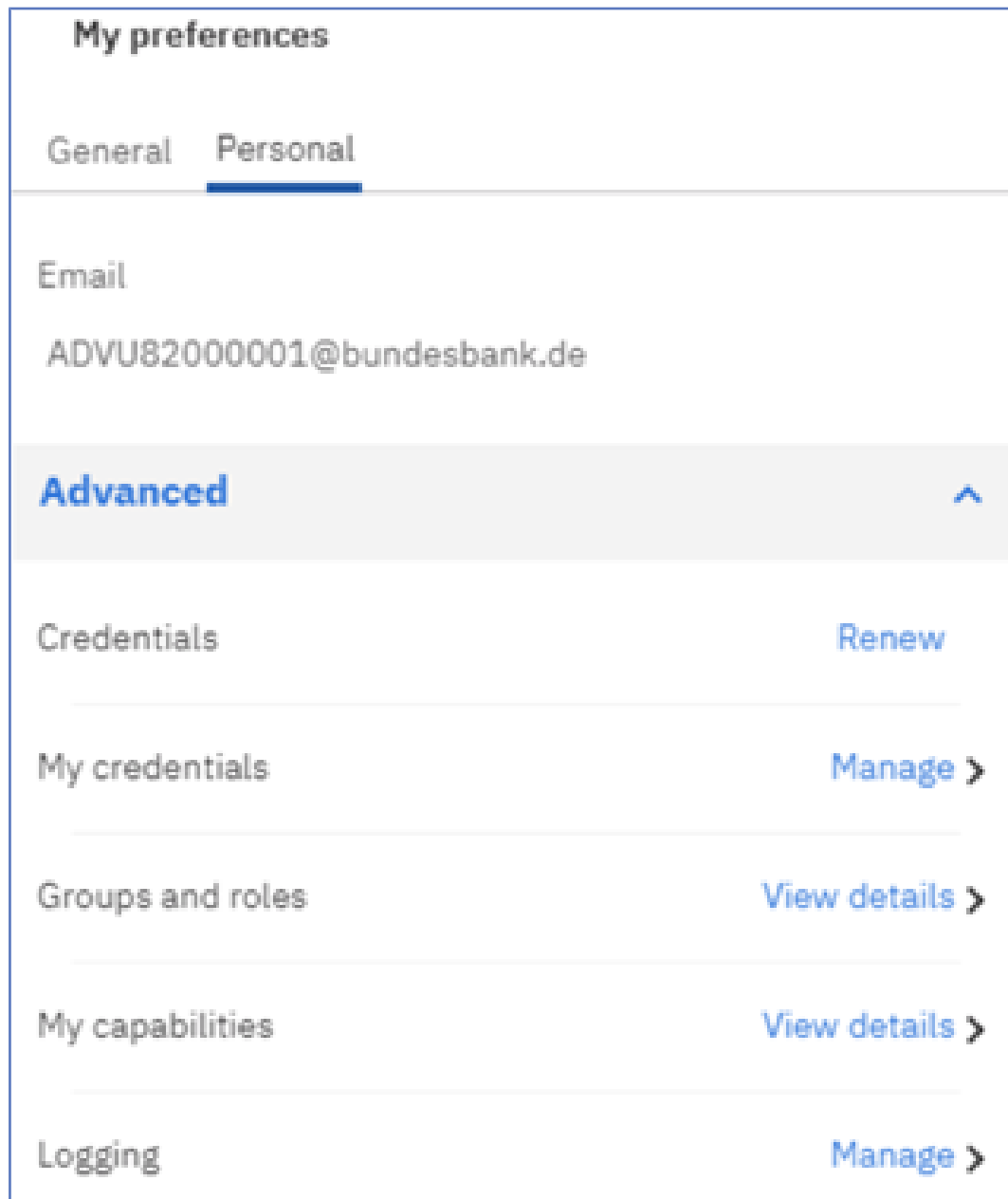

Illustration 180: Welcome screen – Personal menu – My preferences – Personal – Advanced{CR-819}

Groups and Roles

You can find the groups and roles you are associated to by clicking on the respective menu item.

In this example, the user belongs to a Central Bank with country code “KM”. In CRDM the role containing the “Data Warehouse Advanced User”-privilege is granted to the user.

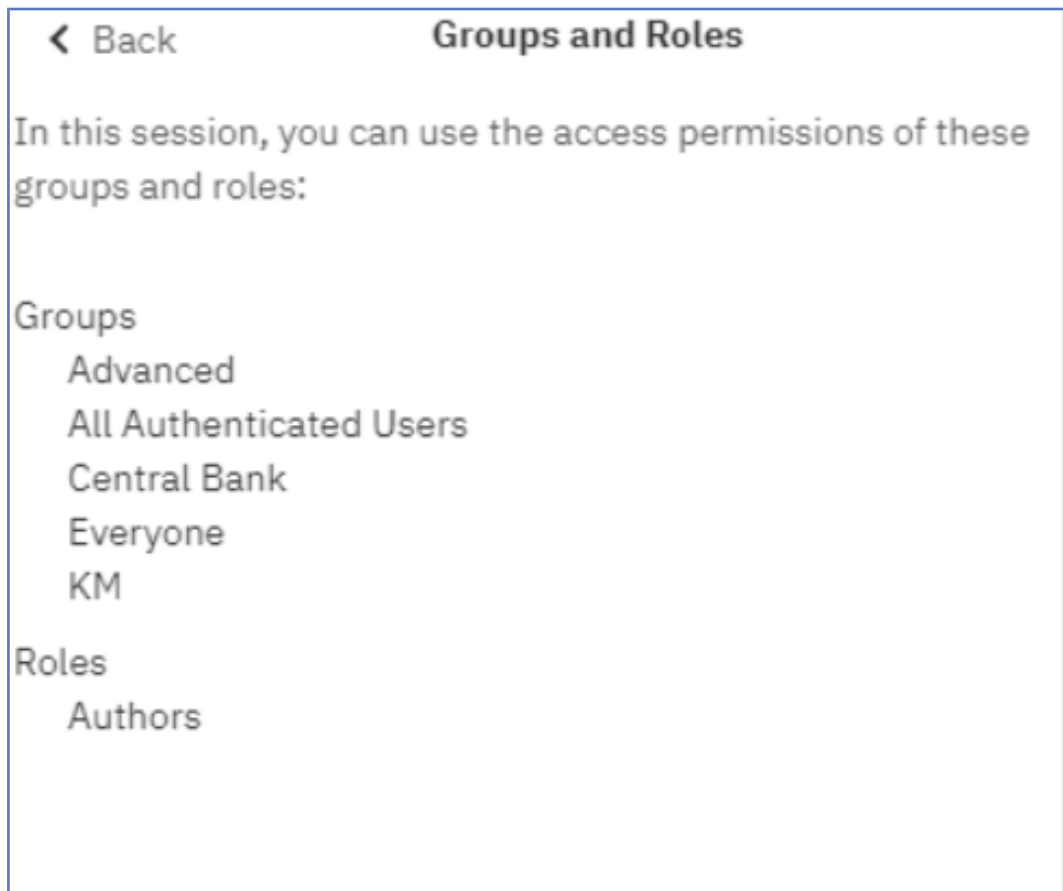

Illustration 181: **Welcome screen – Personal menu – My preferences – Personal – Groups and roles**{CR-819}

User Capabilities

The capabilities control access to different administration tasks and different functional areas of the user interface in DWH. You can find the capabilities assigned to you by clicking on “View details” on the right of the section.{CR-819}

My preferences

General **Personal**

Email
ADVU82000001@bundesbank.de

Advanced ^

Credentials Renew

My credentials Manage >

Groups and roles View details >

My capabilities View details >

Logging Manage >

Illustration 182: **Welcome screen – Personal menu – My preferences – Personal – My capabilities (1){CR-819}**

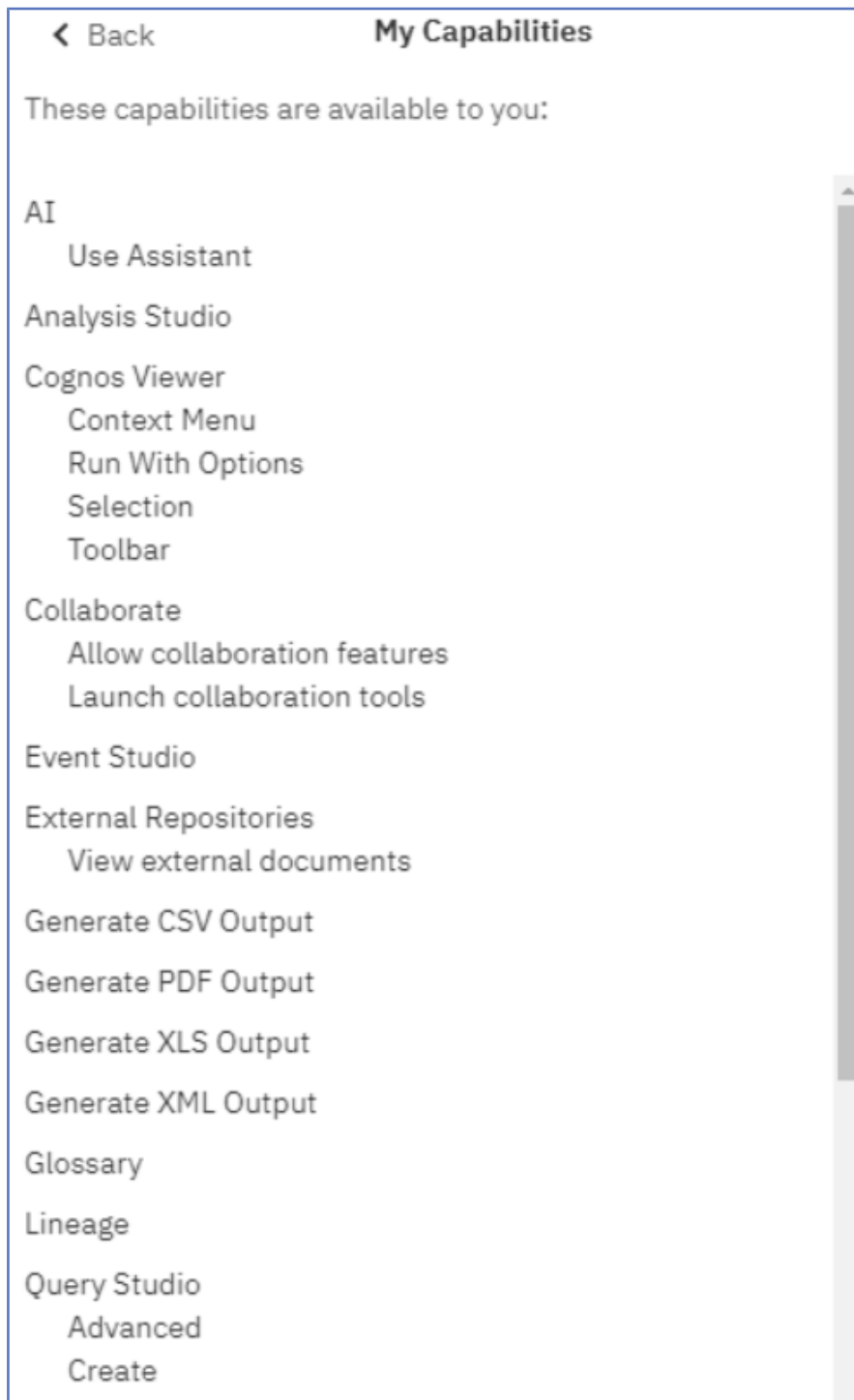

Illustration 183: **Welcome screen – Personal menu – My preferences – Personal – My capabilities (2)** ³³{CR-819}

33 **This content is not applicable as of R6.2, and will become applicable upon the deployment of the Data Warehouse for T2S.** {CR-819}

5.3.2.9.3 Logging

You can use “Logging” to enable detailed, diagnostic logging for your current DWH session. This can be useful to support the analysis of the Operational Teams in case you run into reproducible problems or errors while using the Data Warehouse. In such a case, you can turn logging on and then perform the steps that lead to the problem or error you encountered. Session logging can run for one hour maximum, but can be turned off at any time.

A unique identifier is generated to allow the administrator to identify the session logging data. Record the log identifier before you turn off the logging or close your browser. Please remember to add this identifier to your ticket when requesting help.

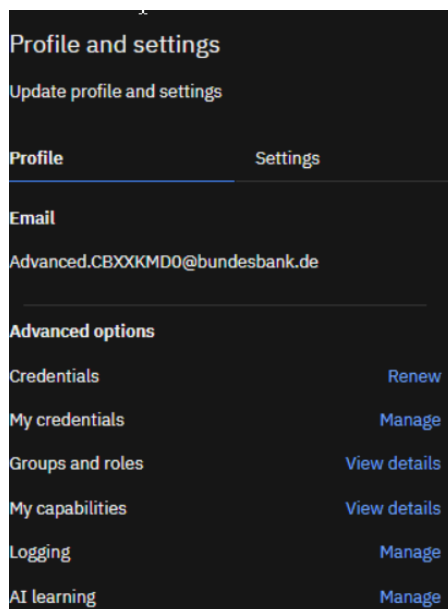

Illustration 184: Welcome screen – Personal menu – Profile and settings - Logging{CR-819}

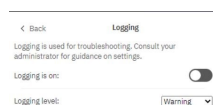

Illustration 185: Welcome screen – Personal menu – Profile and settings – logging{CR-819}

In some circumstances, IBM customer support might direct you to increase the logging level. You can set it to one of the following levels:

Error

Basic level of logging that tracks only major error messages that occur during processing on the client work-station.

Warning

The next level of logging that includes all the information from the Error level of logging and includes warnings about situations that might not affect your system function.

Information

This level of logging aggregates all previous levels of logging and includes more detail about the regular operation of the user interface. You might notice that performance at this level is slower.

Debug

This level of logging contains the most information. Use it if you are testing your own extensions or when you are advised by a member of the software development team or customer support. You can expect that performance at this level is noticeably slower.

Logging levels are stored in the browser cache. If you clear the browser cache, logging levels return to the default setting.{CR-819}

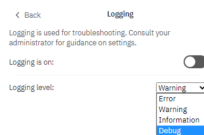

Illustration 186: Welcome screen – Personal menu – Profile and settings - logging level{CR-819}

5.3.2.9.3.1 Profile and Settings - Settings

You can set up settings for your DWH applications. To set your settings in the personal menu click on “Profile and settings” and then “Settings”.

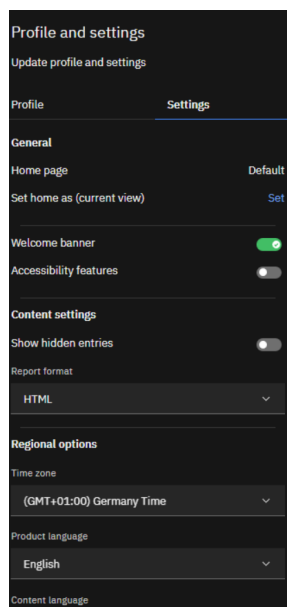

Illustration 187: Welcome screen – Personal menu – Profile and settings – Settings{CR-819}

Home page

In case a different page than the default is set, the user can reset to the default

Report format

The default value for the report format is html

But you can choose also one of the following formats:

- Excel (same content as html but as Excel file)
- Excel Data (only the report data is exported – Not recommended since it does not work properly)
- Pdf
- Html
- Csv
- Xml

Turn on accessibility features

Accessibility features assist users who have a disability, such as restricted mobility or limited vision, to use information technology content successfully

Show hidden entries

When you first sign in to the DWH, you can see hints that help you navigate through the user interface. If you turn the hints off, but want to show them again, select the “Show hidden entries” check box.

Language settings

The default language is English.

You can select the language that you prefer for the DWH user interface. If your data and reports are available in multiple languages, you can also select the language that you prefer for the content. There is also support for bidirectional languages such as Hebrew, Arabic, Urdu, and Farsi. Report authors can control the display of native digits and the direction of text, crosstabs, and charts.{CR-819}

5.3.2.9.4 Log my session

Session Logging

~~You can use “Log my session” to enable detailed, diagnostic logging for your current DWH session. This can be useful to support the analysis of the Operational Teams in case you run into reproducible problems or errors while using the Data Warehouse. In such a case, you can turn logging on and then perform the steps that lead to the problem or error you encountered. Session logging can run for one hour maximum, but can be turned off at any time.~~

Unique Identifier

~~A unique identifier is generated to allow the administrator to identify the session logging data. Record the log identifier before you turn off the logging or close your browser. Remember to add this identifier to your ticket when requesting help.~~{CR-819}

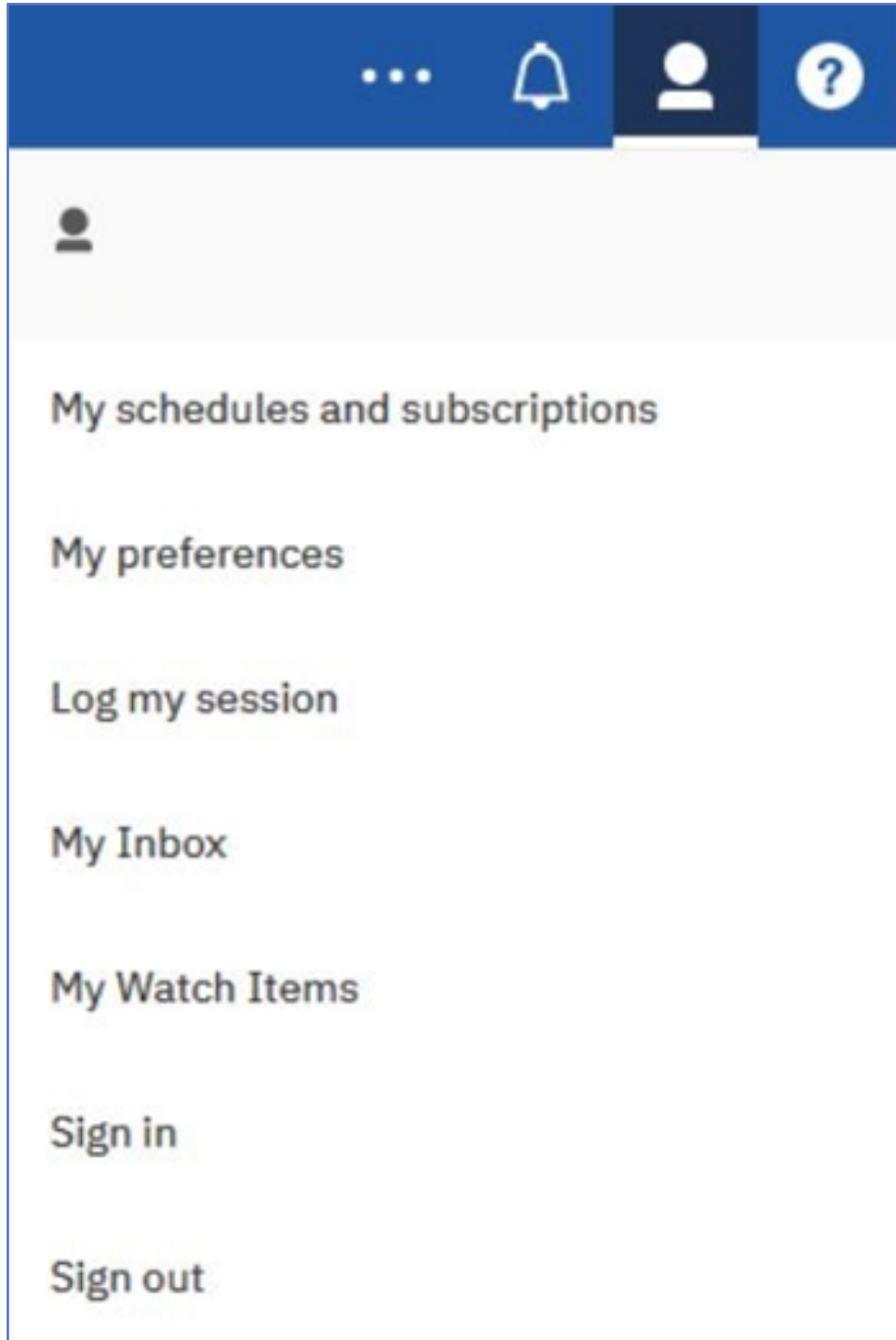

Illustration 188: ~~Welcome screen – Personal menu – Log my session~~{CR-819}

User session logging

Session logging

Off 

Log identifier

--

*Illustration 189: Welcome screen – Personal menu – Log my session – User session logging*³⁴{CR-819}

5.3.2.9.5 My schedules and subscriptions

This menu item allows you to browse through the list of all report runs scheduled for the day. You can view all your scheduled activities and subscriptions on the “**My schedules and subscriptions**” panel.

Subscription Option

The subscription option is available when you run and view a report, but not when you are in editing mode or when you view saved output.

1. In order to subscribe to a report: Run a report.
2. In the application bar, tap “**More**” icon in the application bar () and then

tap the “**Subscribe**” text (.

3. Select your subscription options, and then tap “**Create**”.

The subscriptions have the following characteristics:

A subscriber requires only Read and Execute permissions for the report.

There can be up to 32 subscriptions for the same report.

4. Created by running a report and, in view mode, tapping the “**More**” icon () in the application bar.

Only the subscriber can view their subscription.

Only the most recent saved report output is available.

The report can be run daily or weekly.

Scheduled Activities

You can view a list of your scheduled activities that are current, past, or upcoming on a specific day.

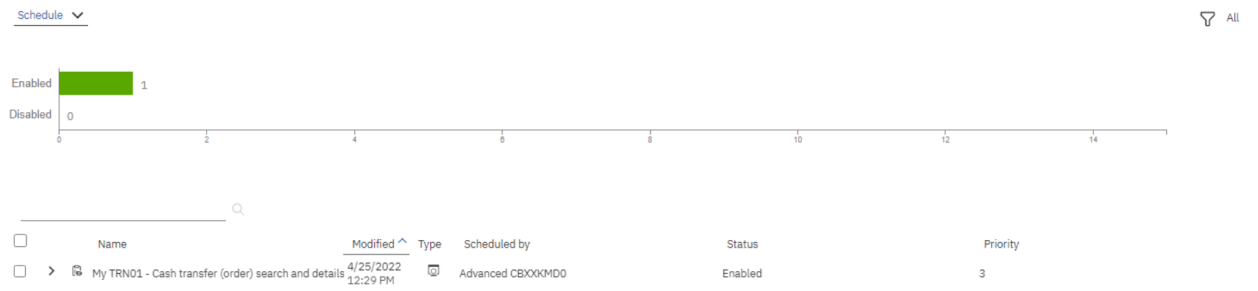

Illustration 190: Welcome screen – Personal menu – My schedules and subscriptions{CR-819}

You can filter the list to show the entries you want to see by clicking on the down arrow next to the “Schedule”.

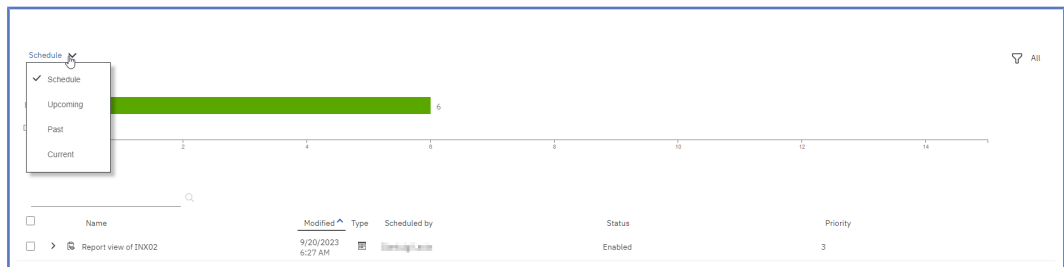

Illustration 191: Welcome screen – Personal menu – My schedules and subscriptions - Filter{CR-819}

The following screenshots show the upcoming and the past schedules respectively:

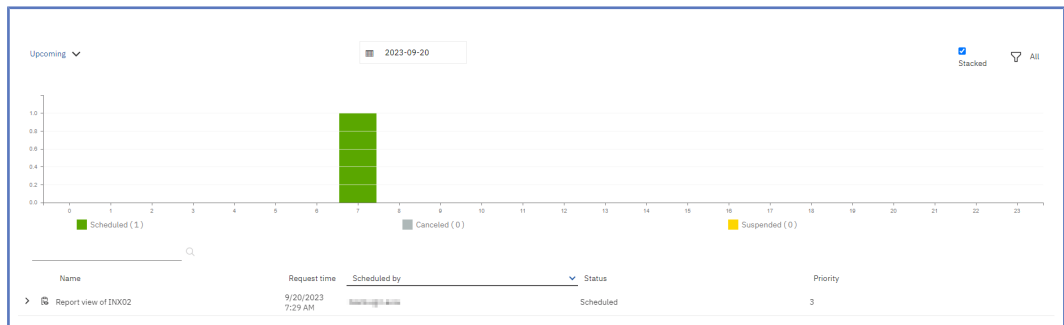

Illustration 192: Welcome screen – Personal menu – My schedules and subscriptions – Upcoming schedules{CR-819}

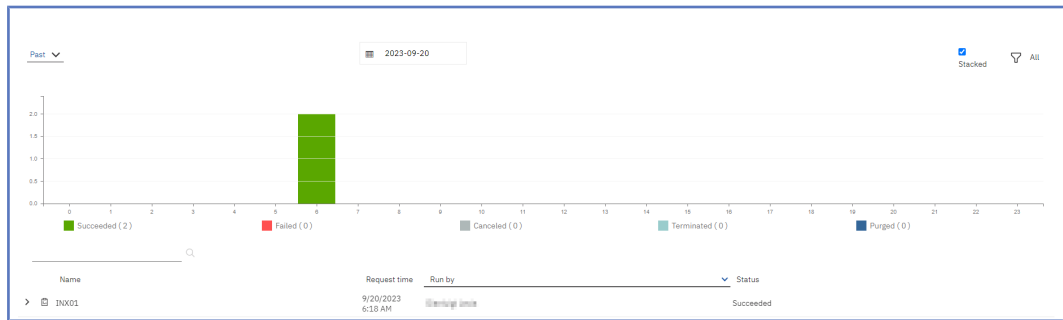

Illustration 193: Welcome screen – Personal menu – My schedules and subscriptions – Past schedules{CR-819}

Subscriptions

In general you can enable, disable, modify, or remove subscriptions, and view their saved outputs or the archived version details panel for information such as the run status and run time.

All this information are available by clicking on the “More” icon (⋮):

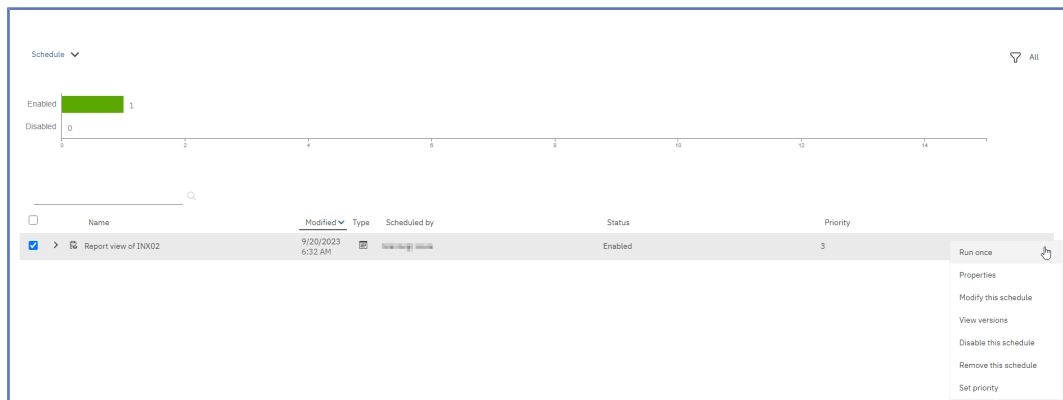

Illustration 194: Welcome screen – Personal menu – My schedules and subscriptions{CR-819}

Status “Enabled”

Enabled: The Status “Enabled” informs the user that the schedule is active.

Run once: By clicking [here on “Run once”](#), the user can run the report once: {CR-819}



Illustration 195: Welcome screen – Personal menu – My schedules and subscriptions – Run as{CR-819}

You can find further information on how to run a report in the chapter Run a report step-by-step [▶ 936].

Properties

By clicking on “Properties”, the user can find information regarding the report: {CR-819}

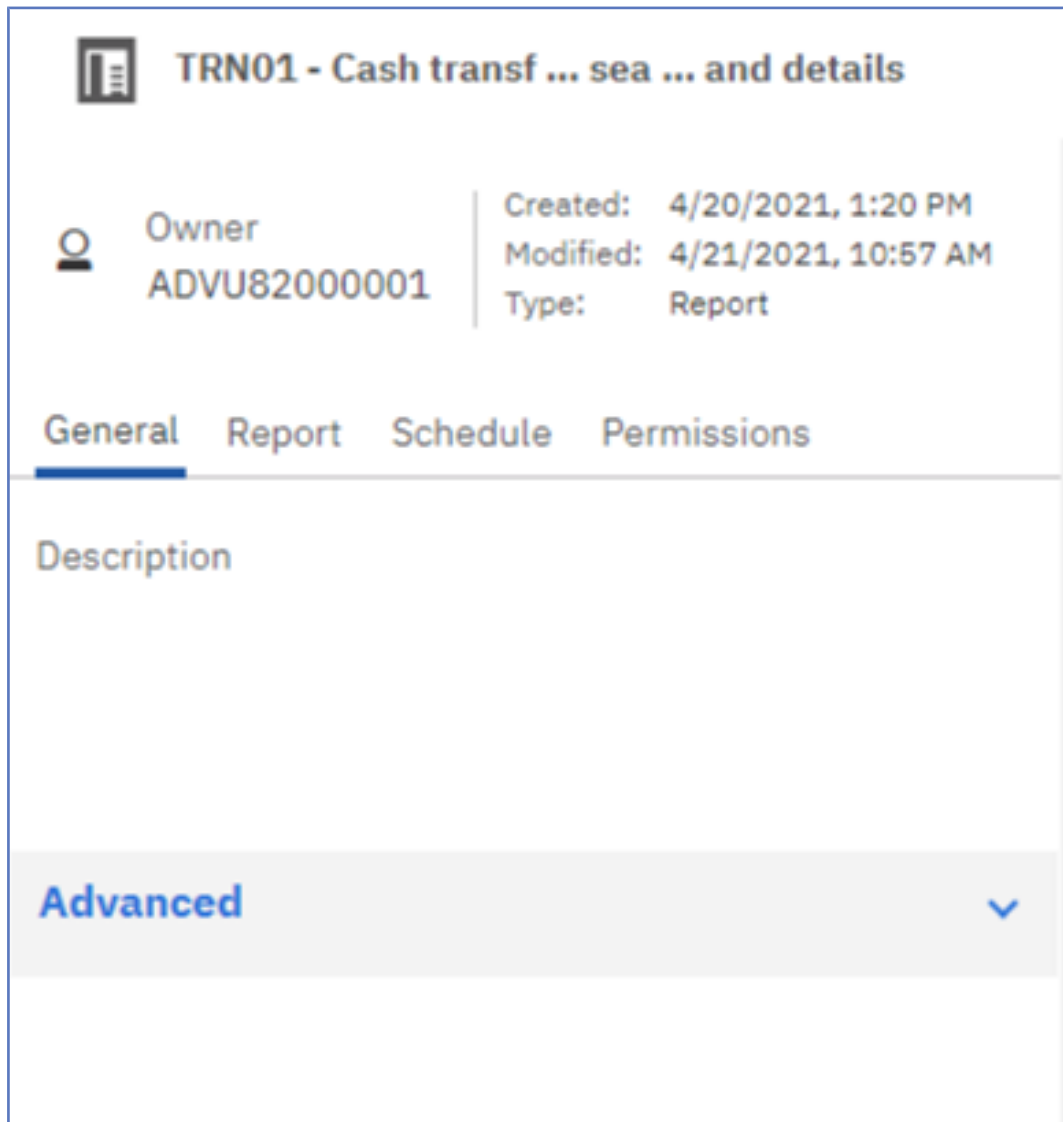

Illustration 196: Welcome screen – Personal menu – My schedules and subscriptions – Properties {CR-819}

Modify

Change the settings for the scheduled report. Modify this subscription: Change the settings for the scheduled report.

Subscribe

When do you want to receive this report?

Repeat on M T W T F S S

Time 🕒 6:50 AM

Format HTML >

Delivery 📄 Save >

Prompts 30 schedule prompt values >

Illustration 197: Welcome screen – Personal menu – My schedules and subscriptions – Modify{CR-819}

View Versions **View versions:** The versions of the report, that is the date it was executed after it was successfully scheduled.

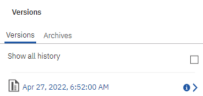

Illustration 198: Welcome screen – Personal menu – My schedules and subscriptions – View versions{CR-819}

Disable Schedule

Disable this schedule: By clicking this option, the user disables the schedule.

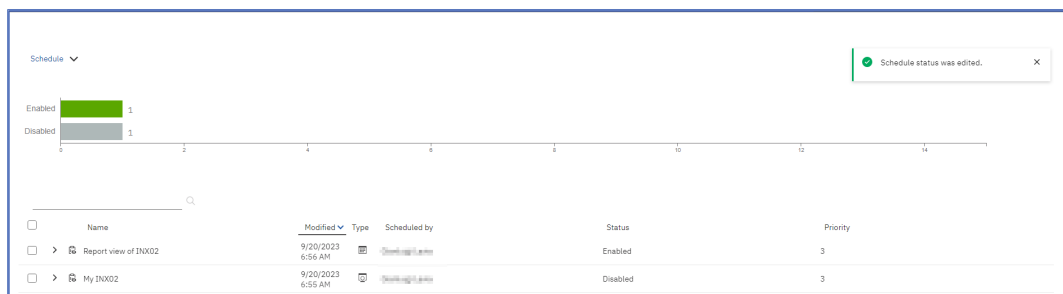

Illustration 199: Welcome screen – Personal menu – My schedules and subscriptions – Disable schedule{CR-819}

Remove Schedule

Remove this schedule: The schedule will be deleted.

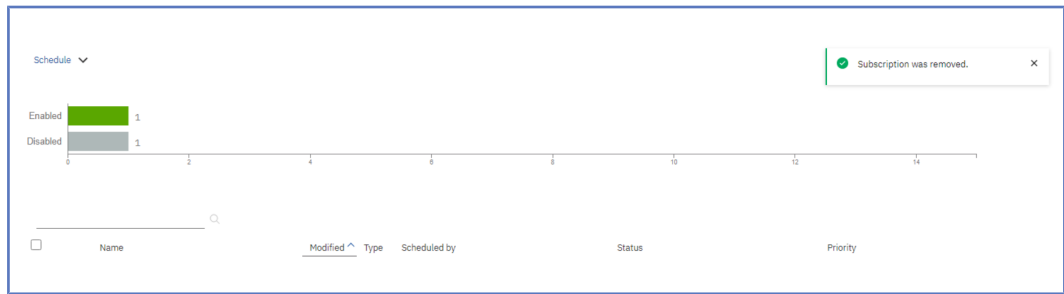

Illustration 200: Welcome screen – Personal menu – My schedules and subscriptions – Re-move schedule{CR-819}

Filter{CR-819} In the top right corner, the user will find another filter.

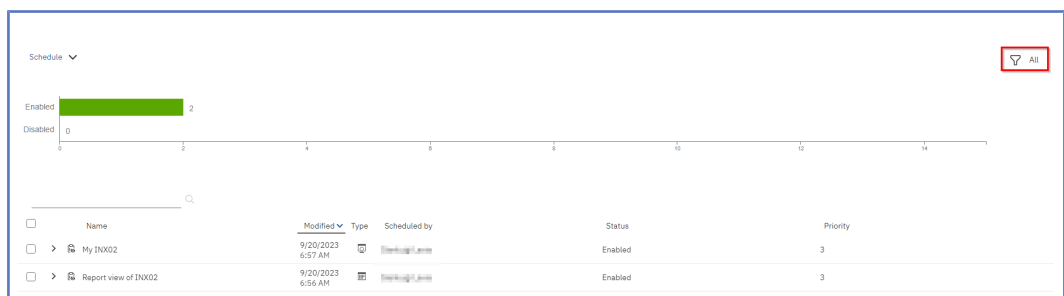



Illustration 201: Welcome screen – Personal menu – My schedules and subscriptions – Filter (2){CR-819}

By clicking on “**All**” ( **All**) button, the user will be presented with further options.

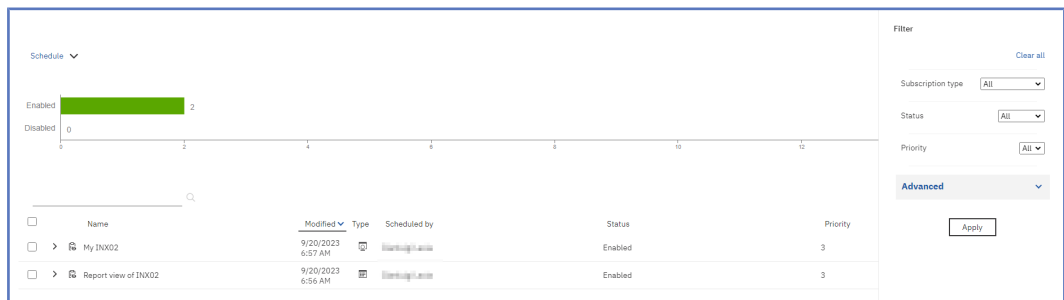
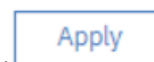
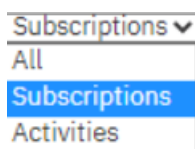

Illustration 202: Welcome screen – Personal menu – My schedules and subscriptions – Filter (2) - Further options{CR-819}

Subscription Type **Subscription type:** By clicking on the dropdown next to the “**Subscription type**” the user will be able to filter to see either the subscriptions or the activities. **{CR-819}**



Verify the choice by clicking on the “**Apply**” button ().



Illustration 203: Welcome screen – Personal menu – My schedules and subscriptions - Subscription type{CR-819}

Status

Status: By clicking on the dropdown next to the “Status”, the user can choose to see either the “Enabled” or the “Disabled” schedules:{CR-819}

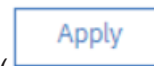
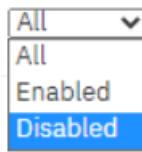

Verify the choice by clicking on the “Apply” button ().



Illustration 204: Welcome screen – Personal menu – My schedules and subscriptions – Status disabled{CR-819}

Priority

Priority: By clicking on the dropdown next to the “Priority”, the user can choose to select different schedules according to the priority.{CR-819}

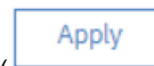
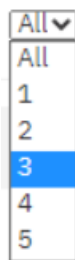

Verify the choice by clicking on the “Apply” button ().

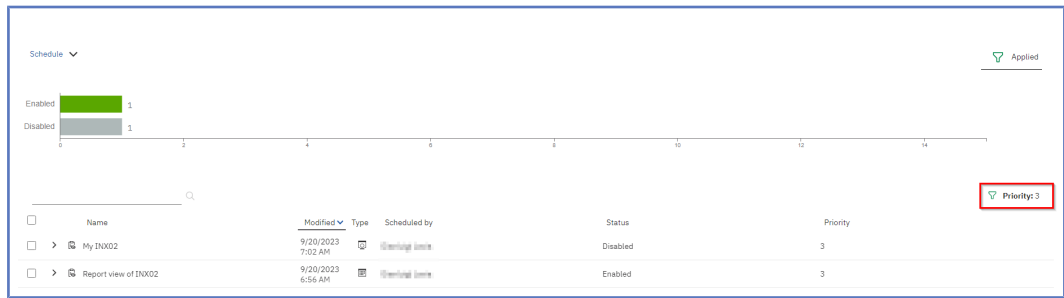

Illustration 205: Welcome screen – Personal menu – My schedules and subscriptions – Schedules Priority{CR-819}

Further Options {CR-819}

By clicking on the down arrow next to “Advanced”, the user is presented with further options.

Filter

[Clear all](#)

Subscription type

Status

Priority

Advanced [^](#)

Type [All >](#)

[Apply](#)

Illustration 206: **Welcome screen – Personal menu – My schedules and subscriptions – Advanced**{CR-819}

Type of Schedule

By clicking on the **“All”** text ([All >](#)) next to the **“Type”**, the user can choose which type of schedule to see, i.e. Report or Reput view:{CR-819}

< Back	Type
Export	<input type="radio"/>
Import	<input type="radio"/>
Index update	<input type="radio"/>
Job	<input type="radio"/>
Migration	<input type="radio"/>
Notebook	<input type="radio"/>
Planning macro	<input type="radio"/>
Planning task	<input type="radio"/>
PowerPlay report	<input type="radio"/>
PowerPlay view	<input type="radio"/>
Query	<input type="radio"/>
Query service administration task	<input type="radio"/>
Report	<input checked="" type="radio"/>
Report view	<input type="radio"/>
Workspace	<input type="radio"/>

Illustration 207: Welcome screen – Personal menu – My schedules and subscriptions – Advanced - All - Type of schedule

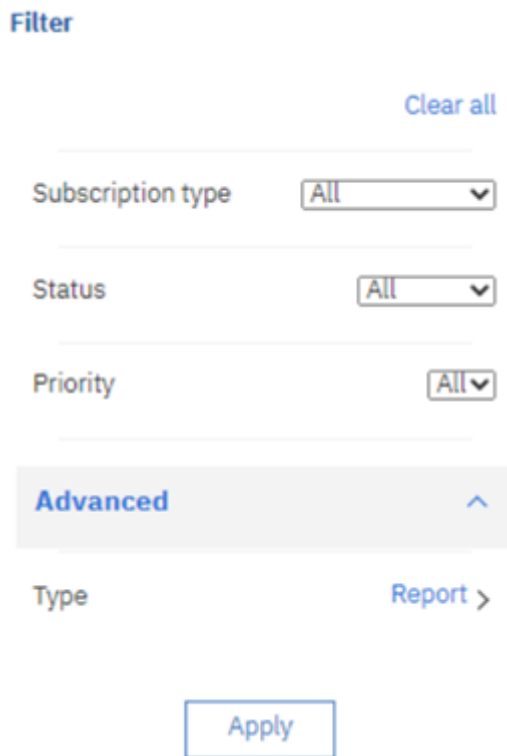

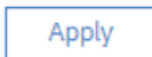

Illustration 208: Welcome screen – Personal menu – My schedules and subscriptions – Advanced - All - Type of schedule – Report

By clicking on “**Back**” text in the upper left corner ( **Back**) and clicking on the “**Apply**” button (), the user can see the type of schedule that has been chosen.

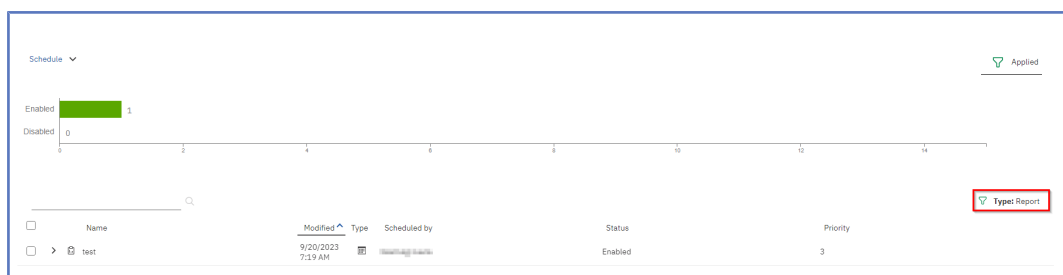

Illustration 209: **Welcome screen – Personal menu – My schedules and subscriptions – Advanced - All - Type of schedule - Report** ³⁵{CR-819}

5.3.2.9.6 My Inbox

If you have selected “Save” as delivery option (refer to chapter Scheduling reports for further information) you can navigate to “My Inbox” in the “Personal menu”.

35 **This content is not applicable as of R6.2, and will become applicable upon the deployment of the Data Warehouse for T2S.** {CR-819}

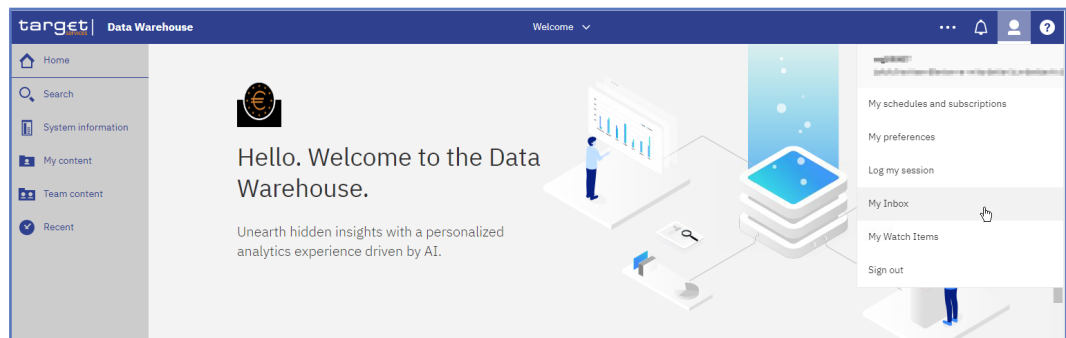

Illustration 210: **Welcome screen – Personal menu – My Inbox**{CR-819}

There you will find the result of the report that you scheduled or run in background. ³⁶{CR-819}

5.3.2.9.7 **Sign Log** out

In order to **signlog** out you can use the “**SignLog out**” item from the personal menu in the toolbar.{CR-819}

36 **This content is not applicable as of R6.2, and will become applicable upon the deployment of the Data Warehouse for T2S.** {CR-819}

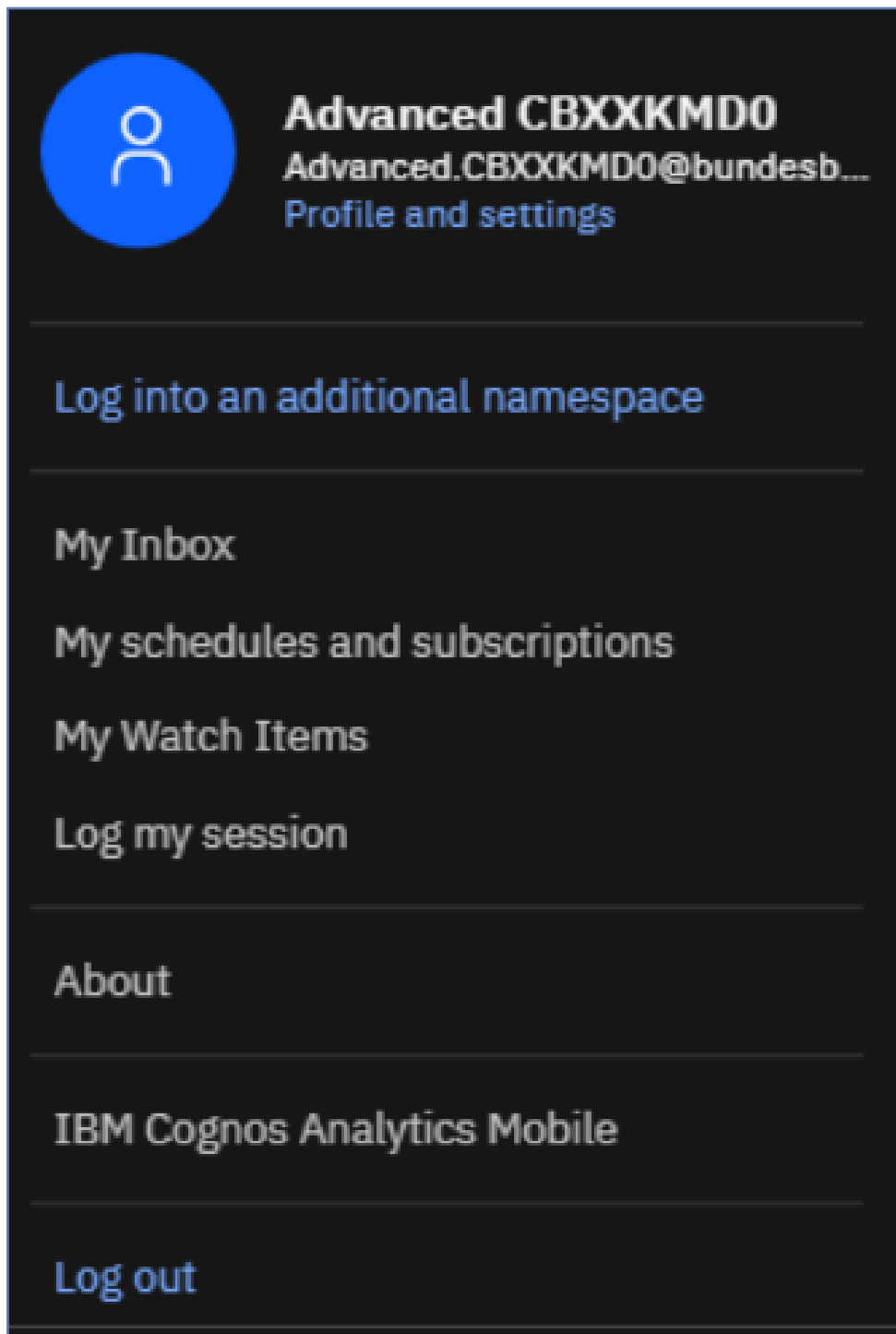

Illustration 211: **Personal menu - Sign out** ³⁷{CR-819}

5.3.2.9.8 My watch items

Change Tracking

In the tab “Alerts” under “My Watch Items” menu, the user can see the reports he has chosen to be notified for any new changes. For further information on Notifications, see chapter Set Notifications.

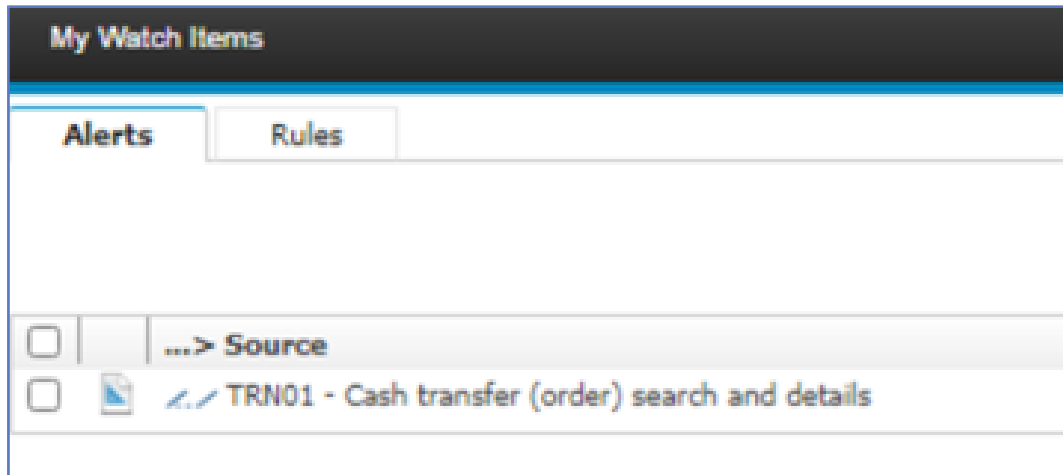

Illustration 212: **Welcome screen – Personal menu – My watch items**{CR-819}

Alert Deactivation

By clicking in the icon at the top right corner, the user can turn off the alerts for this report.³⁸{CR-819}

5.3.2.10 Help menu

“Question Mark” Icon

In the tool bar, you can find a “Question mark” icon, where the default “Help menu” is located.

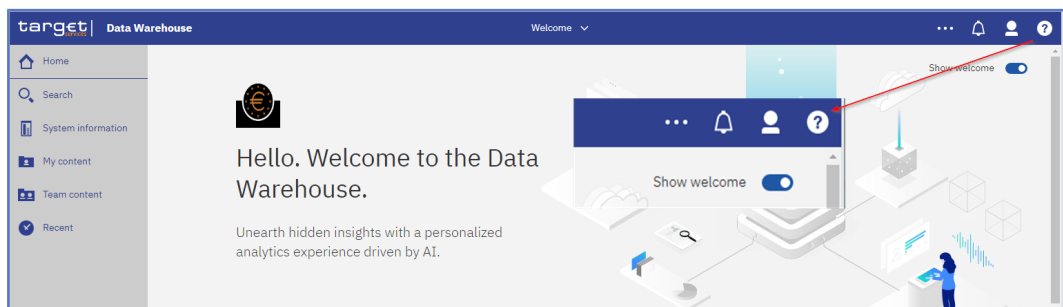

Illustration 213: **Welcome page – Help menu**{CR-819}

Cognos Version

“About” shows information about the Cognos version.{CR-819}

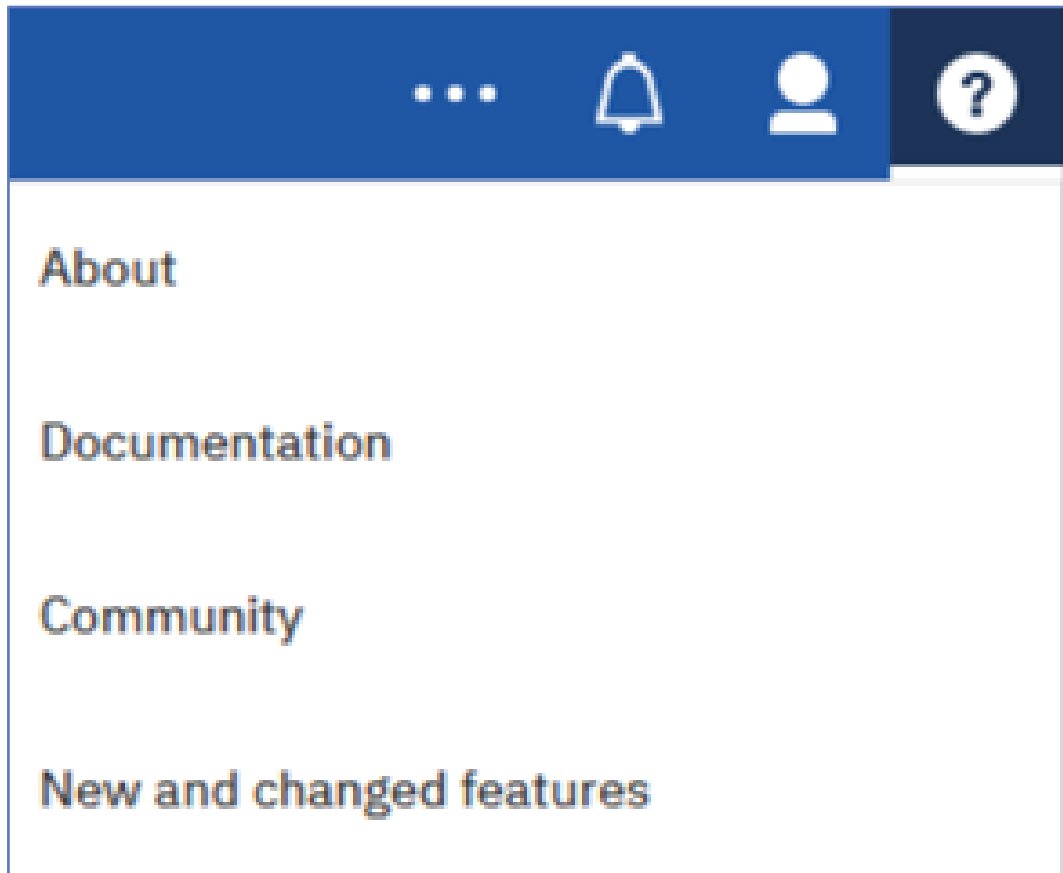

Illustration 214: **Welcome page – Help menu options**{CR-819}

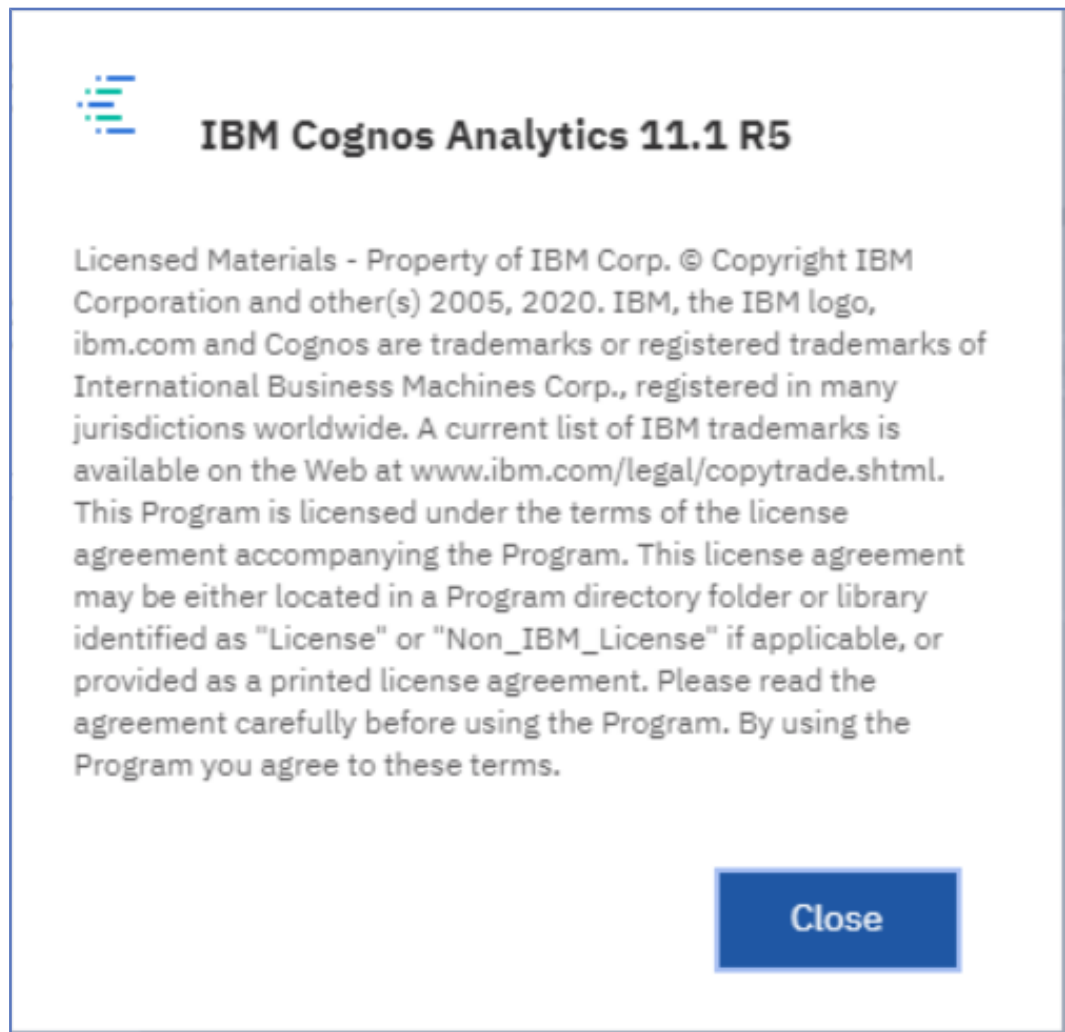



Illustration 215: ~~Welcome page – Help menu – About~~³⁹{CR-819}

5.3.3 Navigating in the DWH GUI – menu

On the left side of the screen you can find ~~athe~~ **“Open”** menu ~~icon~~ () with different folders ~~and the~~ **“System information”** () .{CR-819}

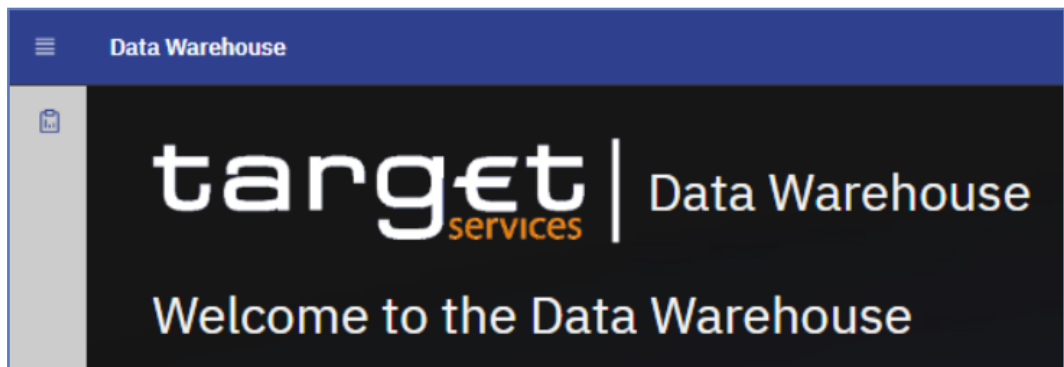

Illustration 216: **Welcome page - menu** ⁴⁰{CR-819}

5.3.3.1 Target services logo

By clicking on the “*Target services*” logo, you return to the “*Welcome*” page. ⁴¹

5.3.3.2 Home icon

The first icon on the left side is the “*Home*” icon.

⁴⁰ This content is not applicable as of R6.2, and will become applicable upon the deployment of the Data Warehouse for T2S.

⁴¹ This content is not applicable as of R6.2, and will become applicable upon the deployment of the Data Warehouse for T2S.

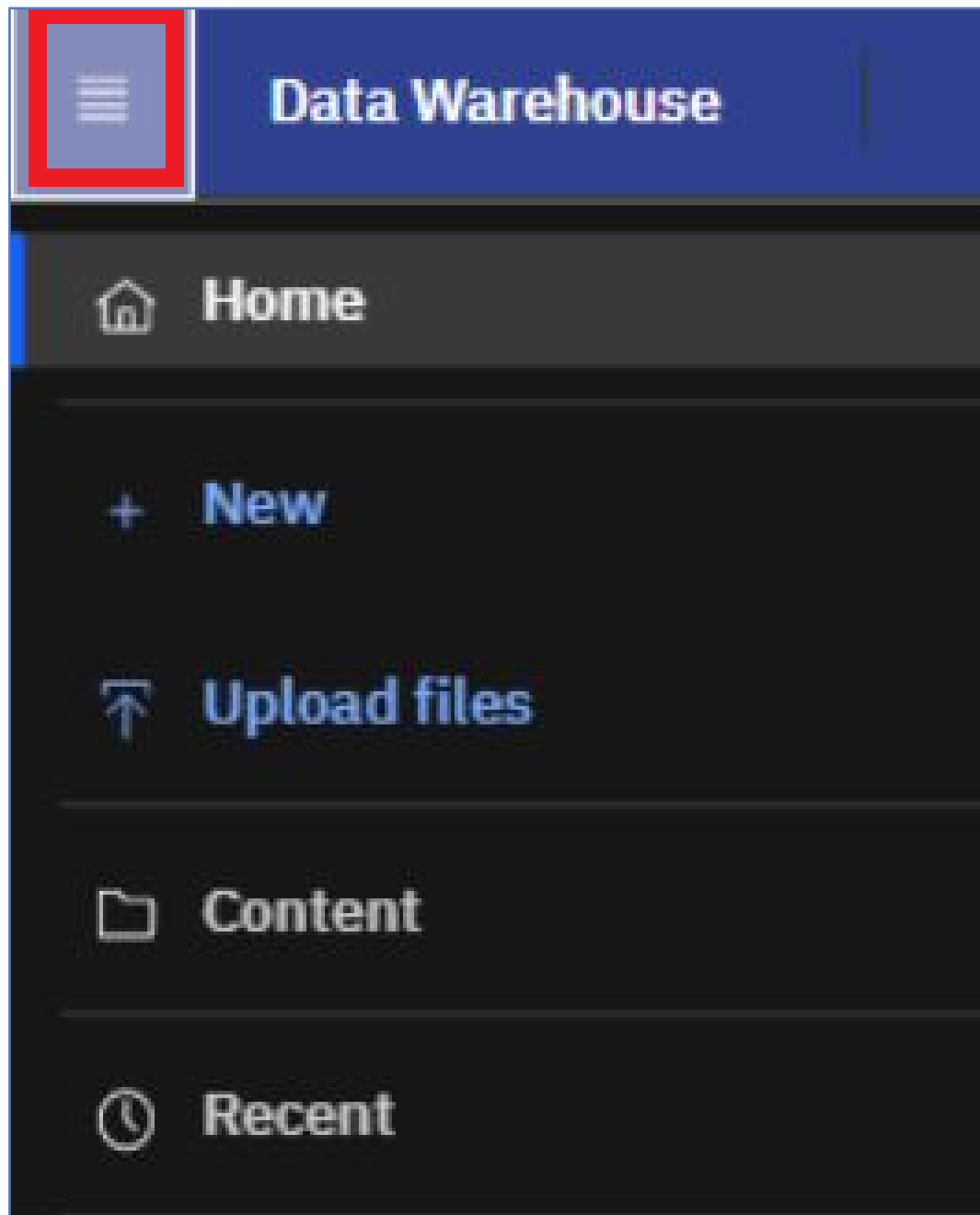

Illustration 217: **Welcome page - Home**{CR-819}

By clicking on this icon it is always possible to return to the “Welcome” page (the standard one or the one you have specified – for further information refer to chapter Access to the DWH [▶ 870]) from everywhere in the DWH GUI. ⁴²

42 This content is not applicable as of R6.2, and will become applicable upon the deployment of the Data Warehouse for T2S.

5.3.3.3 Search function

To find items in your own or in the team content **you can click on type the search term in the “Search” field.**{CR-819} In the search field - you can type in one or multiple keywords and press “Enter”. You can search for folders or pre-defined reports.

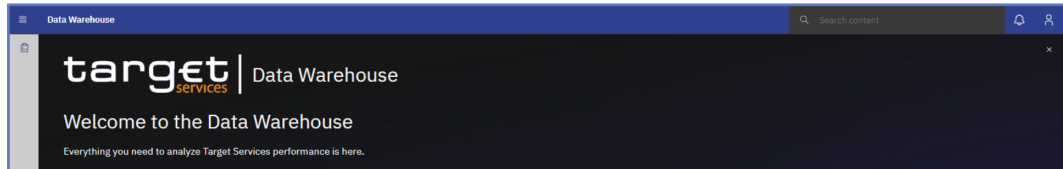

Illustration 218: Welcome page - Search ⁴³{CR-819}

5.3.3.3.1 Narrow your search with filters

After a successful search, the filter function is available. In case your search returns too many results, you can click on the “Filter” icon and select for example specific search results or dates to modify the result list.

Filter Icon

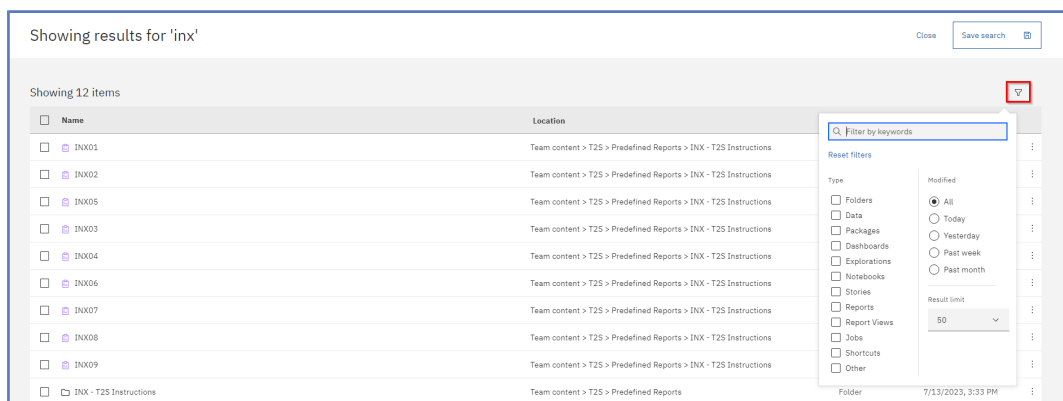

Illustration 219: Welcome page - filter options ⁴⁴{CR-819}

5.3.3.3.2 Save search results

After you have performed a search and the results are shown, you can save the results of your search. The “Save” icon is only available after a successful search.

Save Icon

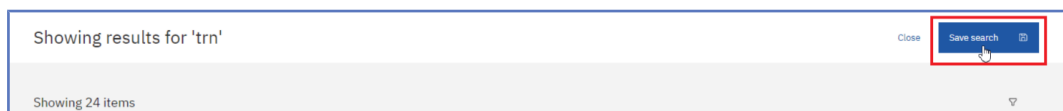

Illustration 220: Welcome page - Search - Save icon{CR-819}

After clicking on the “Save” icon, a message pops up, that informs you that the search was saved.

43 This content is not applicable as of R6.2, and will become applicable upon the deployment of the Data Warehouse for T2S.

44 This content is not applicable as of R6.2, and will become applicable upon the deployment of the Data Warehouse for T2S.

The result of the search will be available later, even after the search is closed, or the user signs out.

If you do not save the result, the next search will overwrite the previous:

In order to delete a previously saved search, click on the “Remove” button of the saved search you intend to delete.

Remove Search



Illustration 221: **Welcome page – remove search**{CR-819}

Save Search

In case you save the search, the search result will be available in the “Saved searches” list, even after you sign out.

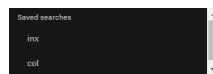

Illustration 222: **Welcome page - Search - Saved searches** ⁴⁵{CR-819}

5.3.3.4 System information

Behind “System information”, you find a menu with a welcome page, **and** user information **and manuals**. {CR-819}

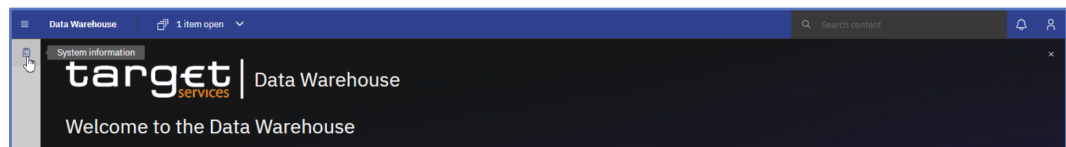

Illustration 223: **Welcome page - System information link**{CR-819}

Welcome Page

This page serves as an introduction to this menu and informs you about the content of this menu.

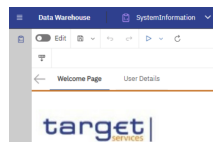

Illustration 224: **Welcome page – System information menu**{CR-819}

User Details

Here you can see additional user information, such as user details concerning your User ID, which is needed to identify you in case of support. In addition, you will find your name, the name of your institution, and system information such as the environment (production or test environment) you are working on. The last business day is also mentioned to give you the information, which was the last business day loaded into the DWH completely.

Manuals

Here you can find the latest User Detailed Functional Specification (UDFS) and UHB version of the DWH.

45 This content is not applicable as of R6.2, and will become applicable upon the deployment of the Data Warehouse for T2S.

When you click on the name of the manual you will be directed to the ECB homepage, where you can find the most recent version of the document you have chosen. ⁴⁶{CR-819}

5.3.3.5 Recent

If you want to see pages, folders or reports that you recently viewed you can find the list under “Recent”.

Recent View

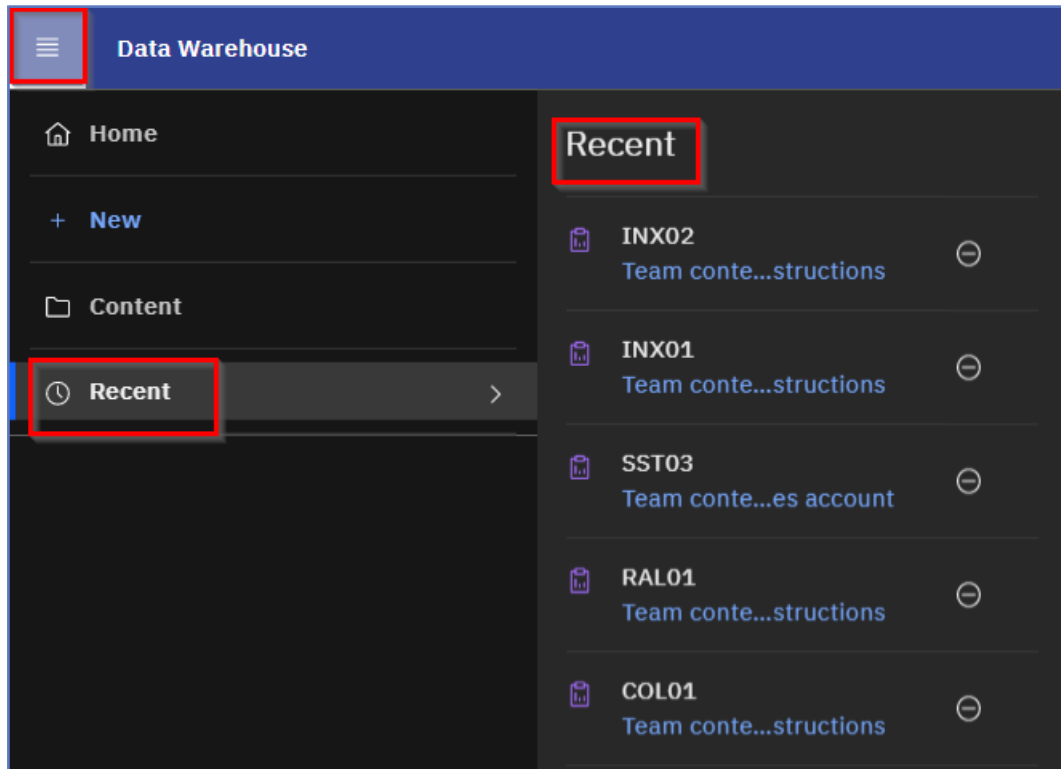

Illustration 225: Welcome page – Recently viewed{CR-819}

Tile View

Apart from that, the Welcome page shows all recently viewed items under the lower part, where you can also switch from “tile view” to “list view” by using the icons in the right part of the screen.

When “Tile View” is chosen the recently viewed items are organised as tiles.

46 **This content is not applicable as of R6.2, and will become applicable upon the deployment of the Data Warehouse for T2S.** {CR-819}

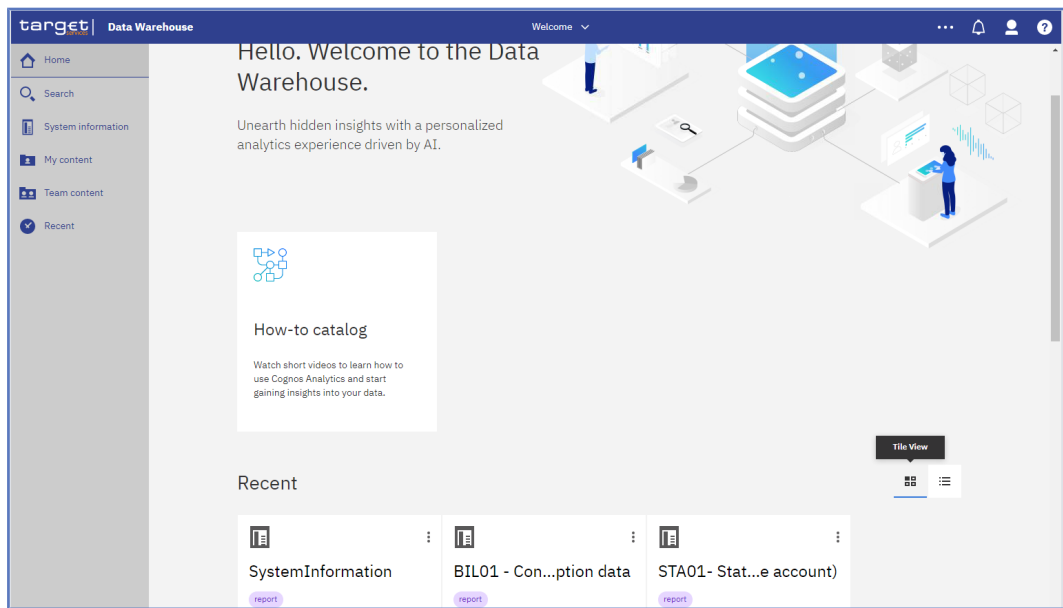

Illustration 226: Welcome page – tile view {CR-819}

List View

When the “List View” is chosen, the recently viewed items are organised in a list. {CR-819}

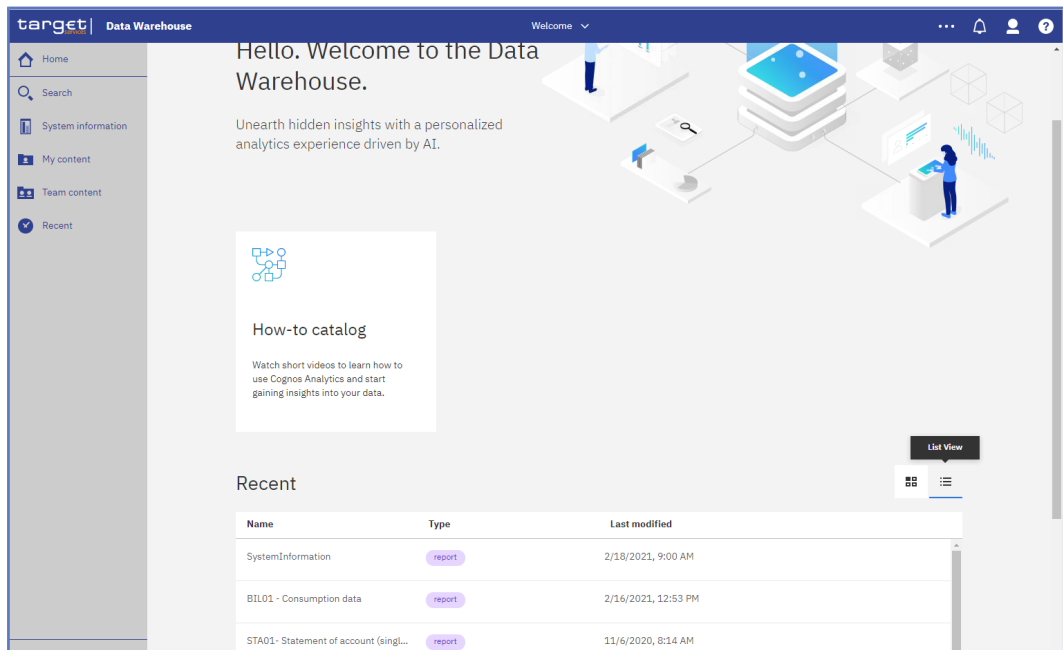

Illustration 227: Welcome page – list view ⁴⁷ {CR-819}

47 **This content is not applicable as of R6.2, and will become applicable upon the deployment of the Data Warehouse for T2S. {CR-819}**

5.3.3.6 New

The “New” option is only visible for CB/CSD users granted with the “*Data Warehouse advanced user*” privilege in CRDM. Only with this privilege it is allowed to create user-defined reports. For more information refer to the DWH UHB chapter *Creating reports (just advanced users)*.

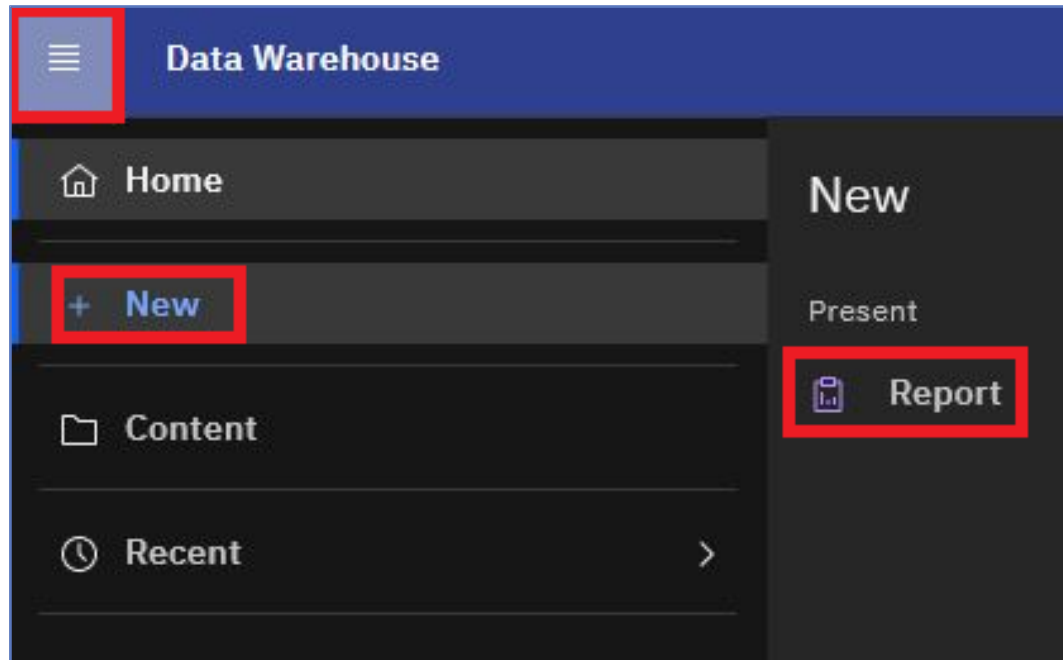

Illustration 228: Welcome page - New ⁴⁸{CR-819}

5.3.4 Personal Folders

5.3.4.1 Team content

After clicking on the “Open menu” icon and then clicking on “Content”, you will be presented with a screen having two tabs, “My content” and “Team content”.{CR-819} Under “*Team content*”, you can find all reports you are allowed to run and view, depending on the party type you belong to. For information about each predefined report and who is allowed to use it, refer to *Predefined reports* [▶ 964]. For CB/CSD users a specific CB/CSD folder can be found, where CB advanced users can store adapted or user-defined reports and share them with normal users within their CB/CSD. This enables also other users of this CB/CSD with the normal user privilege to execute reports previously designed by an advanced user.

48 This content is not applicable as of R6.2, and will become applicable upon the deployment of the Data Warehouse for T2S.

**CB/CSD
Shared
Folders**

Additionally, the CBs/CSDs shared folder is included in here. With this folder, CBs/CSDs can share reports with other CBs/CSDs.

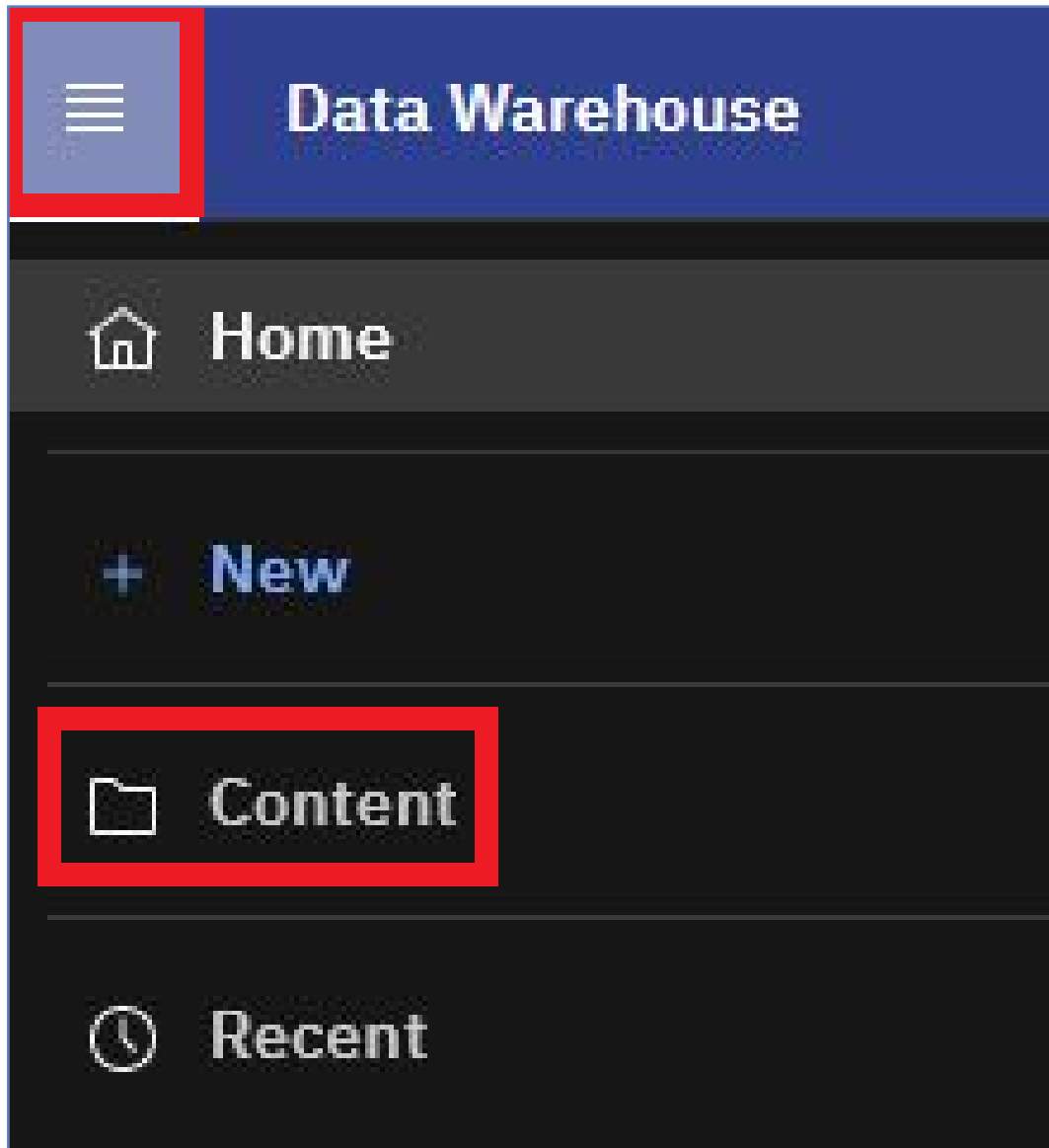

Illustration 229: Welcome page - Team content{CR-819}

You can see the following content within “*Team content*”.

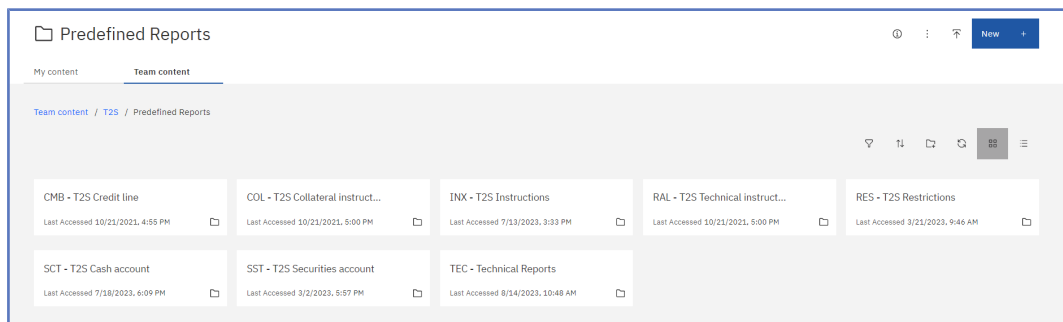

Illustration 230: Welcome page- Team content - folder structure{CR-819}

In case you are a CB/CSD user, you will see this structure in “*Team content*”:

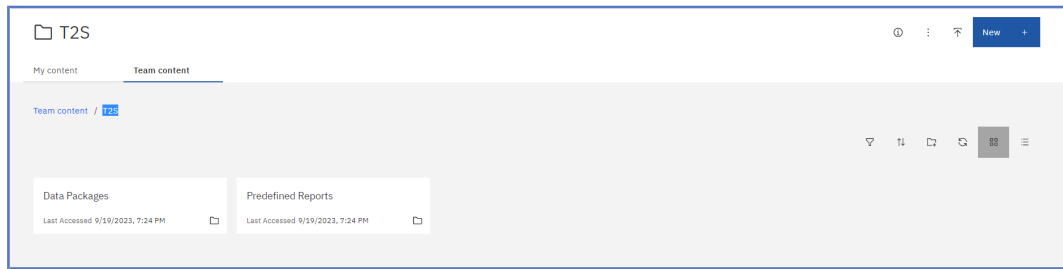

Illustration 231: Welcome page - Team content - folder structure (CB user) {CR-819}

~~In the “CB/CSD shared folders” the CB/CSD user can find the folders for sharing reports within its own CB/CSD as well as the folder for sharing reports with other CBs/CSDs.~~{CR-819}

Data Packages

In the “Data Packages” folder, you can find the data model that was used to create the reports. This is an information item only (showing the date and time of the last update of the data model).

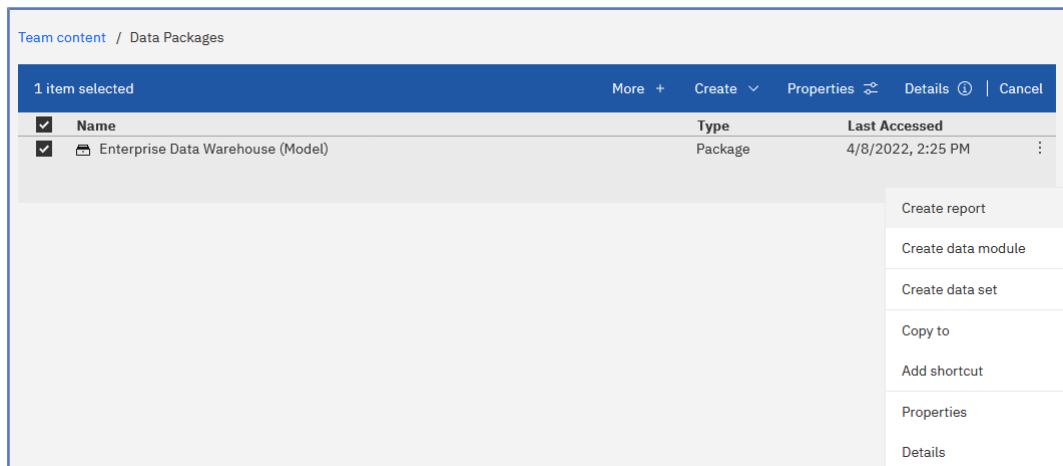

Illustration 232: Welcome page - Team content - Data Packages{CR-819}

Predefined Reports

In the “Predefined Reports” folder you can find the subfolders containing the predefined reports.

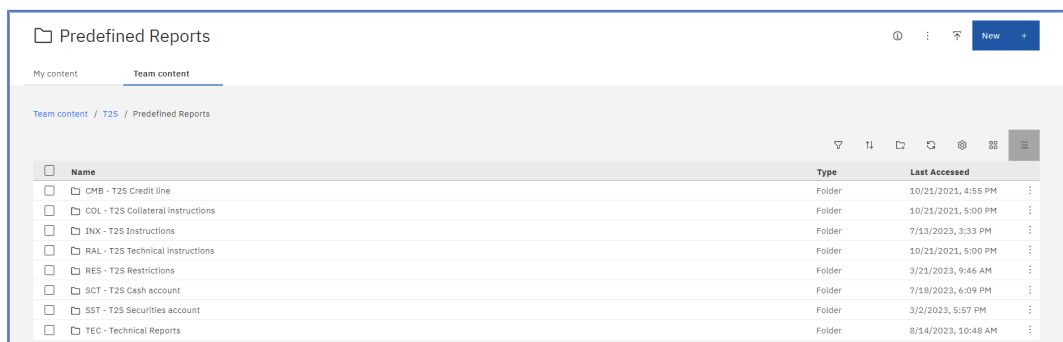

Illustration 233: Welcome page - Team content - Predefined reports{CR-819}

Example

Under “~~ANS – Ancillary System Reports~~RES01 - T2S Restrictions” you can find the predefined reports “~~ANS01 – Overview of AS transfer orders~~” and “~~ANS02 – Daily average of AS transfers~~RES01and”.{CR-819}

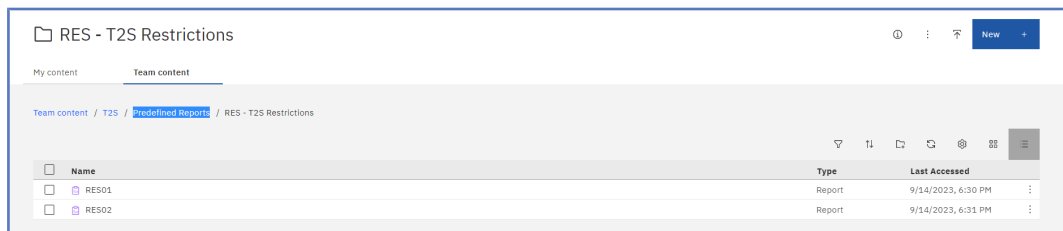

Illustration 234: Welcome page - Team content - Predefined Reports - ANS--Ancillary System-RES – T2S Restrictions Reports{CR-819}

The normal user has the same capabilities, except from the “Create report”.⁴⁹

5.3.4.2 My content

This is your private area where only you can see the content that is stored there. At start, the folder is always empty.

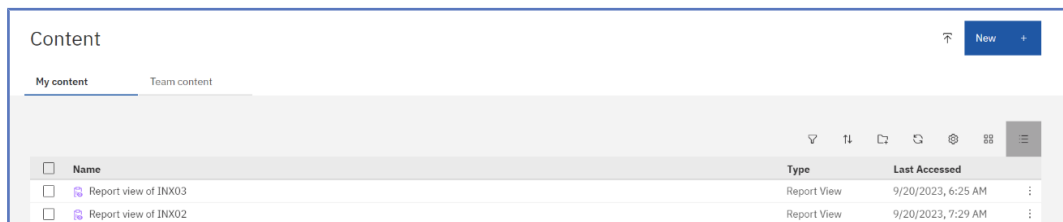



Illustration 235: Welcome page – My content⁵⁰{CR-819}

5.3.4.3 Add a new folder

Open “My content” or “Team content” and click on the “+” sign in the toolbar and then on “New Folder”. Click on the “Open menu” icon (), click on “Content” and then click on “My content”. In order to create a new folder, click on the “Add Folder” icon ().{CR-819}

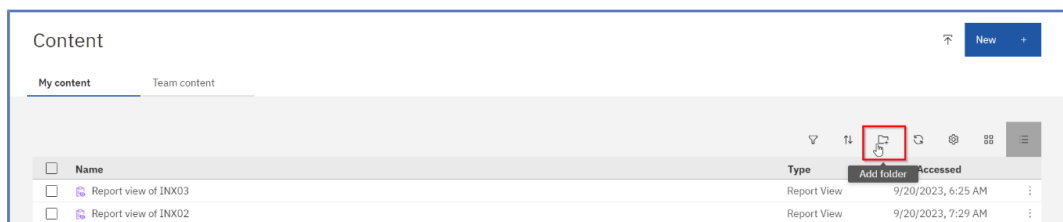

Illustration 236: Welcome page – My content – Add folder{CR-819}

New Folder

After click on the “Add Folder” icon, you must enter a name for the new folder you want to create.{CR-819}

49 This content is not applicable as of R6.2, and will become applicable upon the deployment of the Data Warehouse for T2S.

50 This content is not applicable as of R6.2, and will become applicable upon the deployment of the Data Warehouse for T2S.

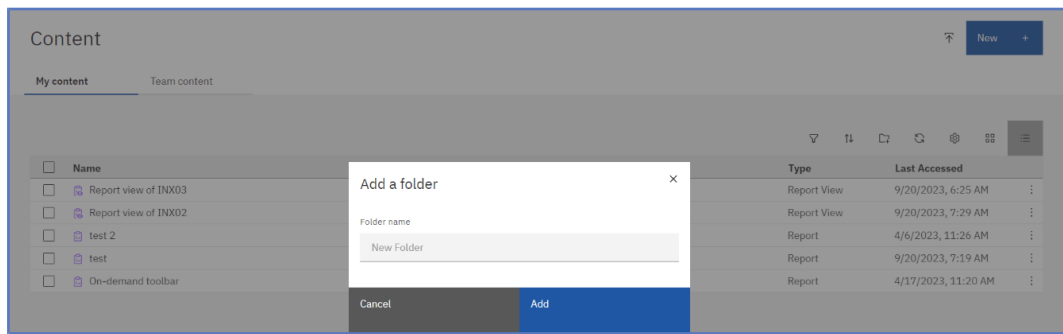

Illustration 237: Welcome page – My content – New Folder{CR-819}

Press “Enter” and the new folder is created.⁵¹

5.3.4.4 Sort the content

Open “My content” or “Team content” **by clicking on the “Open menu” icon and then clicking on “Content”**, and click on the “Sort” icon in the toolbar.

{CR-819} You can sort by name, the latest modification date or type of the content. In addition, you can decide if you want to see the ascending or descending order of your items.

Sorting Order

In the following screenshot, the folders are sorted by name in ascending order.

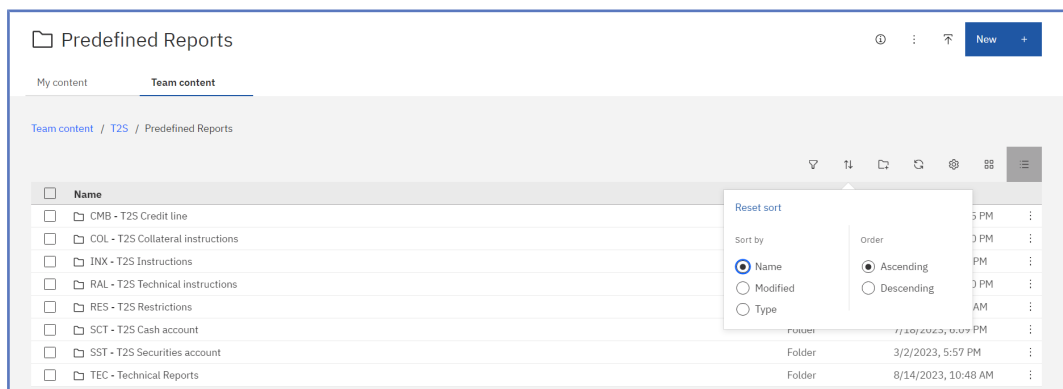

Illustration 238: Welcome page – My content – sort in ascending order{CR-819}

On the contrary, in this screenshot the folders are sorted by name in descending order.

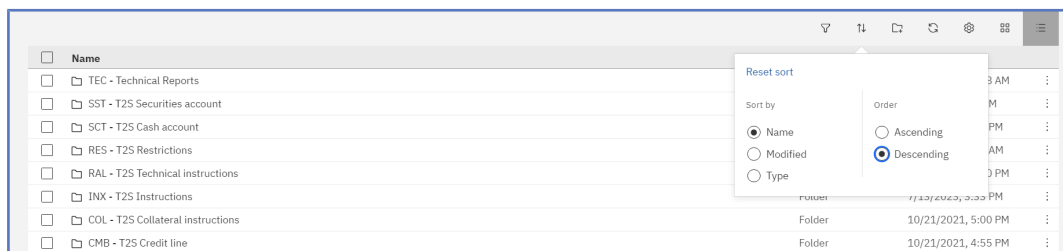

Illustration 239: Welcome page – My content – sort in descending order⁵²{CR-819}

51 This content is not applicable as of R6.2, and will become applicable upon the deployment of the Data Warehouse for T2S.

52 This content is not applicable as of R6.2, and will become applicable upon the deployment of the Data Warehouse for T2S.

5.3.4.5 Filter the content

Open “My content” or “Team content” **by clicking on the ”Open menu” icon and then clicking on “Content”**, and click on the “Filter” icon in the toolbar.

{CR-819} You can choose the type, the modified time or provide one ore multiple keywords of the item you are looking for.

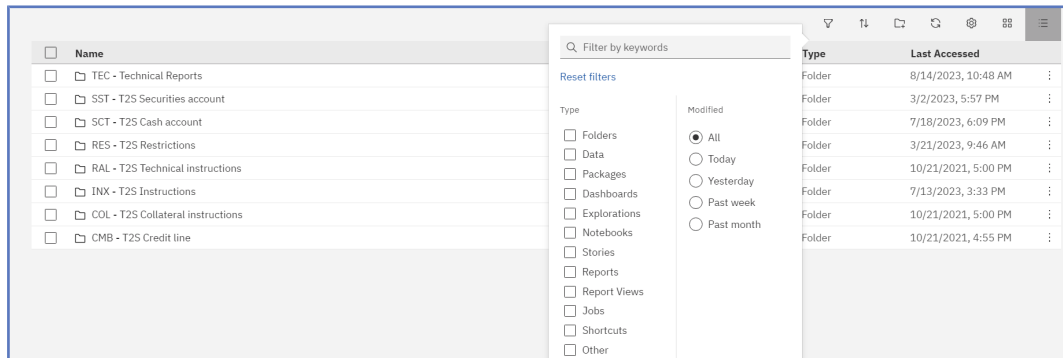

Illustration 240: Welcome page – Team content – T2S - Predefined Reports – filter options {CR-819}

Example

You want to search for a folder in combination with a keyword “**STFRE**”. {CR-819} The following result is shown:

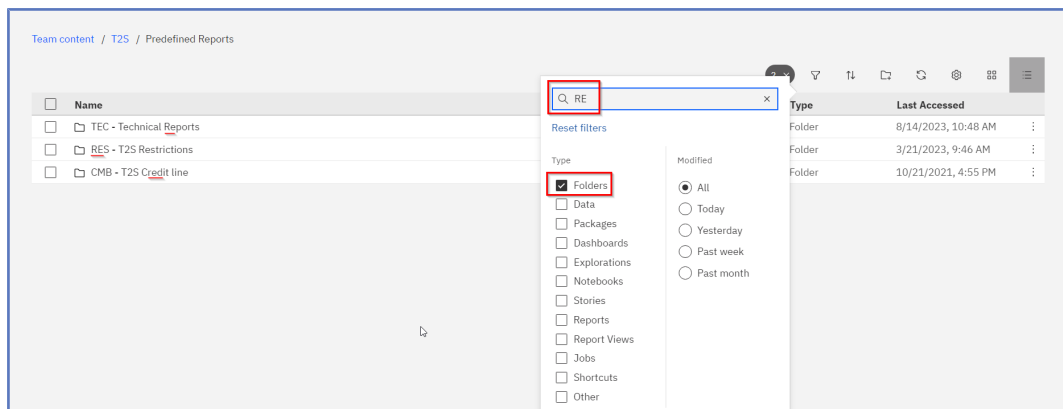

Illustration 241: Welcome page – My content – filter options – filter by folders ⁵³{CR-819}

5.4 Working with reports

5.4.1 Copy, save and export

This chapter gives you a step-by-step description on how to copy the report to your own folder or to save or export the data. ⁵⁴

⁵³ This content is not applicable as of R6.2, and will become applicable upon the deployment of the Data Warehouse for T2S.

⁵⁴ This content is not applicable as of R6.2, and will become applicable upon the deployment of the Data Warehouse for T2S.

5.4.1.1 Copy a report

Context of Usage

A copy is an independent version of the original report. Any changes to the implementation due to e.g. CRs in the original report will not affect the report results from the copied version. Deleting the original report will not affect the copy. This is the difference to the report view (see chapter Creating a report view [▶ 927]) which remains linked to the original report. You can save a report as a copy in “My content” folder, or if the user is a member of a Central Bank or CSD, in the CB/CSD shared folders as well:

Instructions

1. Navigate to the “Team content” >> **folder, click on “T2S” and open “Predefined Reports”** and select the folder with the desired report.

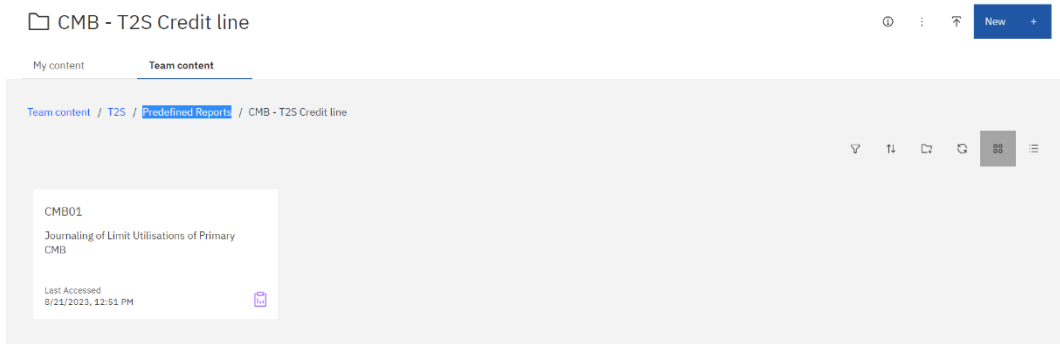



Illustration 242: Team content - T2S - Predefined Reports - CMB - T2S Credit line{CR-819}

2. Choose the report that should be copied and click on the “**More Action menu**” icon () at the right of the report and select “Copy to”.

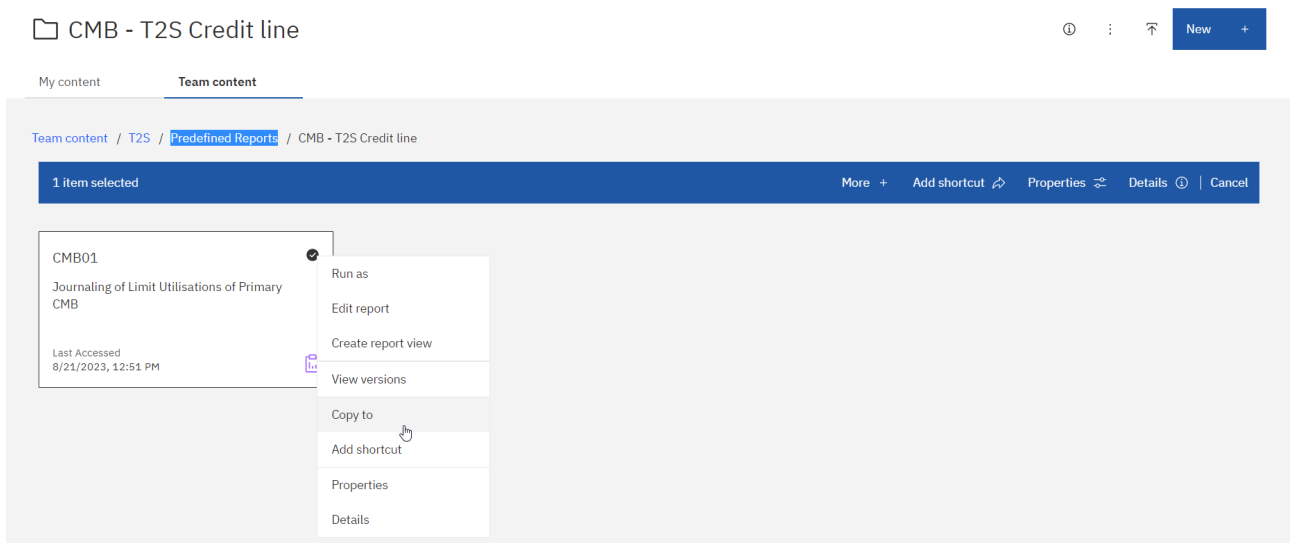

Illustration 243: Team content - T2S - Predefined Reports - CMB - T2S Credit line Copy to{CR-819}

3. A window pops up to save the report. You can save the reports in the “My content”, **or in the CB shared folders**, by clicking on the “Copy to” button you move a copy of the report to your own working space **in the DWH**.
{CR-819}

Copy CMB01

Selected destination: My content



Illustration 244: Team content - Predefined Reports – T2S – Predefined Reports - STF – Standing Facilities Reports – STF01 – Standing Facility information CMB01 – T2S Credit line – Copy to {CR-819}

4. **Afterwards you can find the report in the respective folder. In this example in “My Content”.**



Hint

~~If you a CB/CSD user, you can also copy the report into the CB/CSD shared folder or CB/CSD – “Country code shared” folder, which can be found in the path: Team content >> CB (CSD) Shared folders. Both folder are only visible for CB/CSD user. Afterwards you can find the report in the respective folder.~~ ⁵⁵{CR-819}

5.4.1.2 Creating a report view

Context of usage

The report view is the same report as the predefined report, but has different properties such as prompt values, schedules, delivery methods, run options, languages, and output formats. A report view is an alias of the original report and remains linked to it. If the source report is moved to another location, the report view link is not broken. If the source report is deleted, the report view link is broken and the properties link to the source report is removed. In case the report has been changed (e.g. due to a new software release), the user will be prompted with this information. The “Report view” icon () changes to indicate that the link is broken and is no longer operable. In order to schedule the run of a report (see chapter Scheduling reports [▶ 953]), you have to create a report view first.
{CR-819}

55 **This content is not applicable as of R6.2, and will become applicable upon the deployment of the Data Warehouse for T2S.**
{CR-819}

These steps have to be executed in order to create a report view of the chosen report:

- Instructions**
1. Navigate to the **“Team content”** >> **folder, click on “T2S” and open “Pre-defined Reports”** and select the folder with the desired report. **{CR-819}**

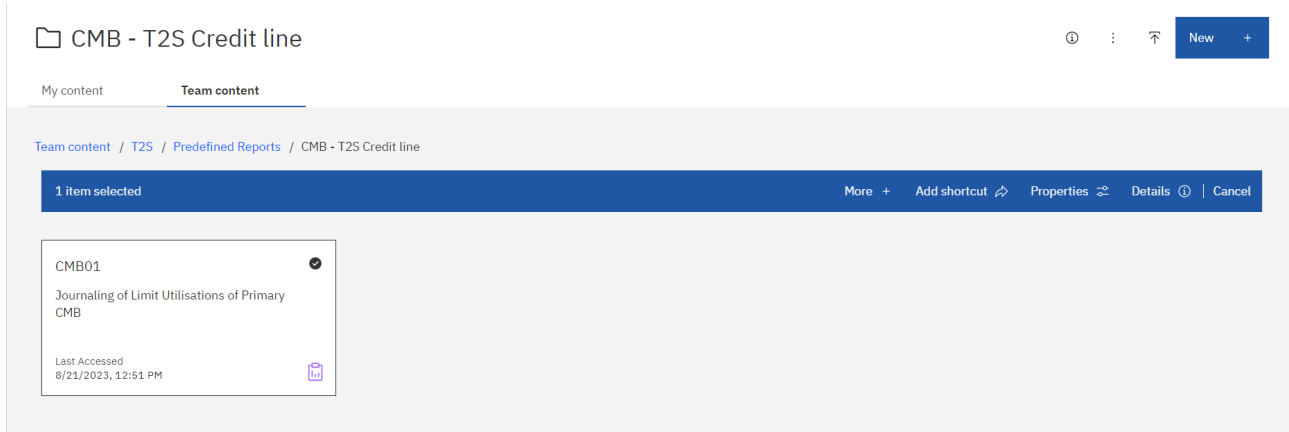

Illustration 245: Team content - T2S - Predefined Reports - STF - T2S Credit line{CR-819}

2. Choose the report for that a view should be created and click on the **“More”** icon (**⋮**) at the right of the report and select **“Create report view”**. **{CR-819}**

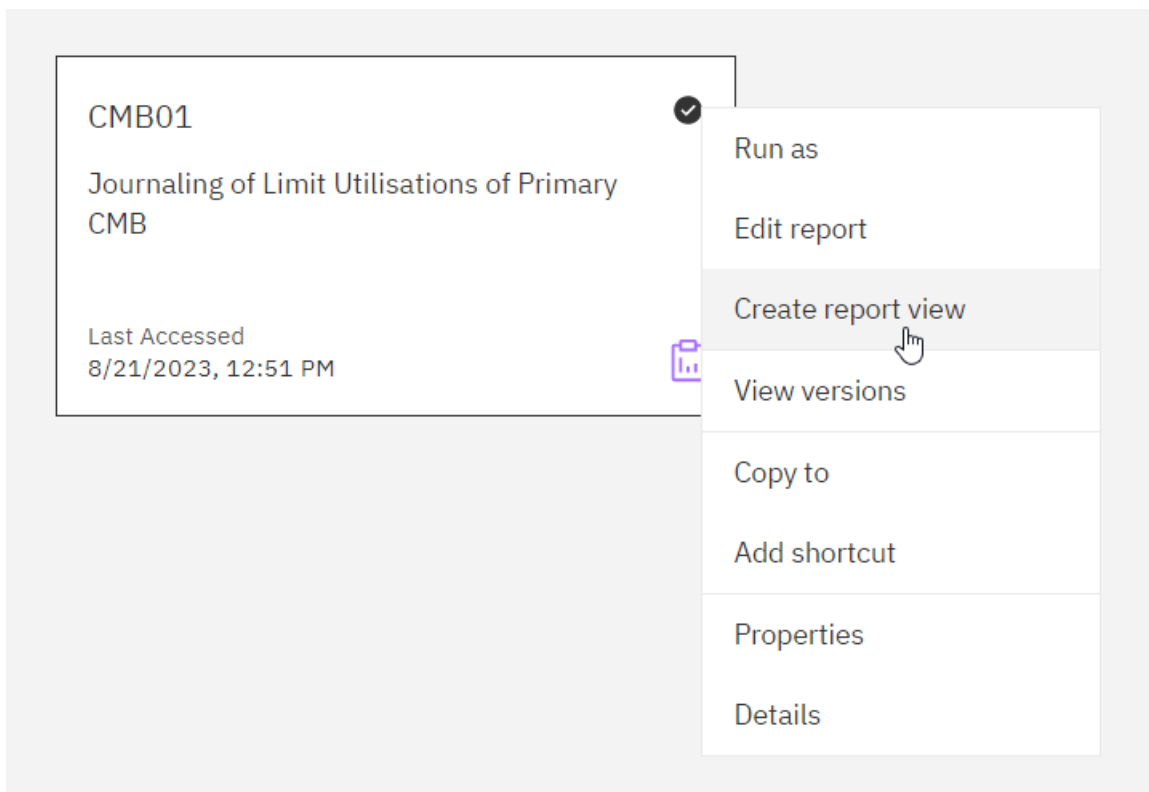

Illustration 246: Team content - Predefined Reports -- STF -- Standing Facilities Reports -- STF01 -- Standing Facility information- T2S --- Predefined Reports - CMB - T2S Credit line- Create report view{CR-819}

3. A pop up window opens and you can save the report view in **“My content”** after entering a name and by clicking on the **“Save”** button.

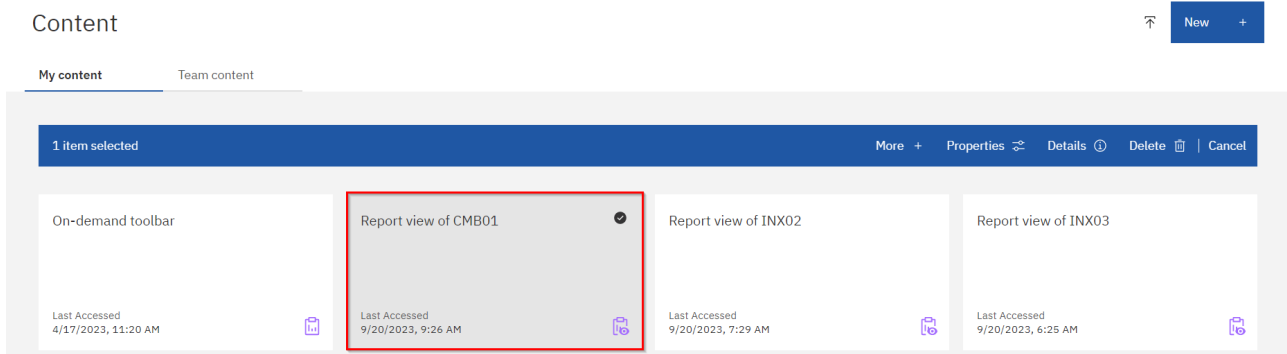

Illustration 247: **My content - report view**{CR-819}

4. **You can find the report view in the respective folder. In this example in “My content”.**
5. You can determine the source report for a report view by clicking on the properties.

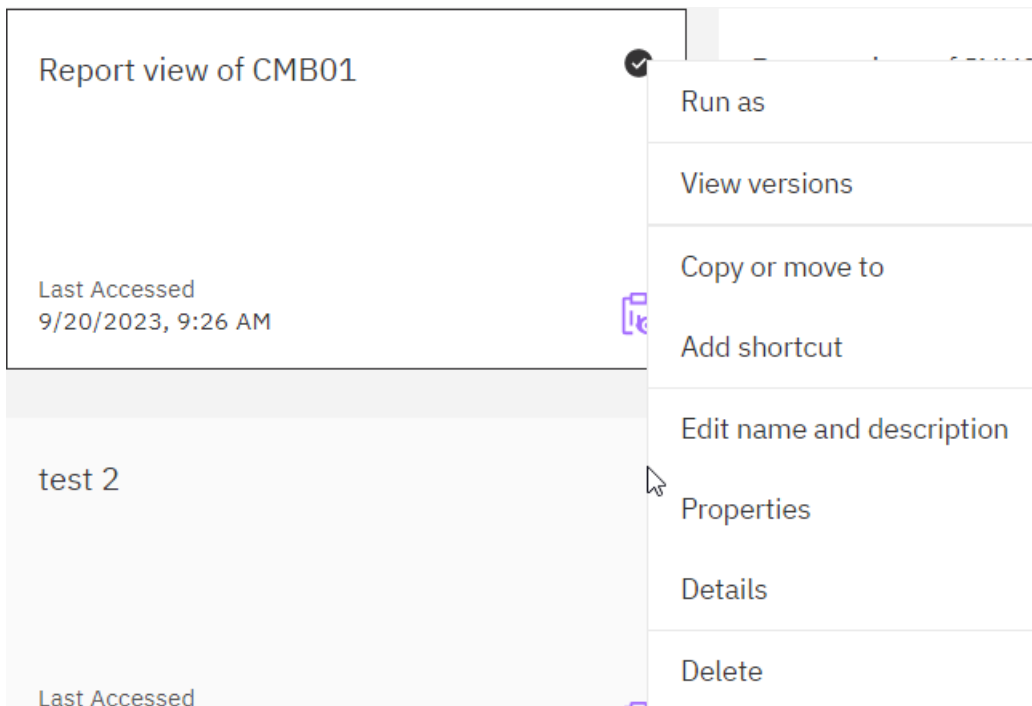

Illustration 248: **My content - report view - Properties**{CR-819}

6. Scroll down to **“General”**.
The report view properties also provide a link to the properties of the source report.

 Report view of CMB01

General Report Schedule Permissions

Description

Journaling of Limit Utilisations of Primary CMB

Advanced 

Disable this entry

Location My content

Search path CAMID("CognosUsersInternal:u

ID i23686E6362214ED68DF3C720DA34D4EC

Permission Full 

Languages Set...

Source report Set...

Team content > T2S > Pr ... T2S Credit line > CMB01

Illustration 249: **My content - report view - Properties - Source report**{CR-819}

- ~~7. When the source report is deleted, the report view title is greyed and the link to the source report is missing in the properties:~~{CR-819}

Illustration 250: ~~My content – report view – Properties – Source report deleted~~{CR-819}



Hint

~~If you are a CB/CSD user, you can also save the report view into the CB/CSD shared folder or CB/CSD – “Country code” shared folder, which can be found in the path: Team content >> CB (CSD) Shared folders. You can find the report view in the respective folder.~~{CR-819}

**Hint**

~~You will be notified by the „notify me“ option in case of change in your created report views. For further details on Notifications see chapter Personal menu.~~⁵⁶{CR-819}

5.4.1.3 Saving a report output

Context of Usage

You can save the report output (meaning the result of the run of a report, see chapter Running reports [▶ 935]) in DWH for future uses by creating a report view first.

Instructions

1. Create a report view as described in chapter Creating a report view [▶ 927].
2. Navigate to the folder containing the report view you have created.
3. Run the report as described in chapter Run a report step-by-step [▶ 936].
4. You can view the output by clicking on the “More” icon () next to the report in “My content” **and select “View versions”**.
5. **Select “View versions”**{CR-819}

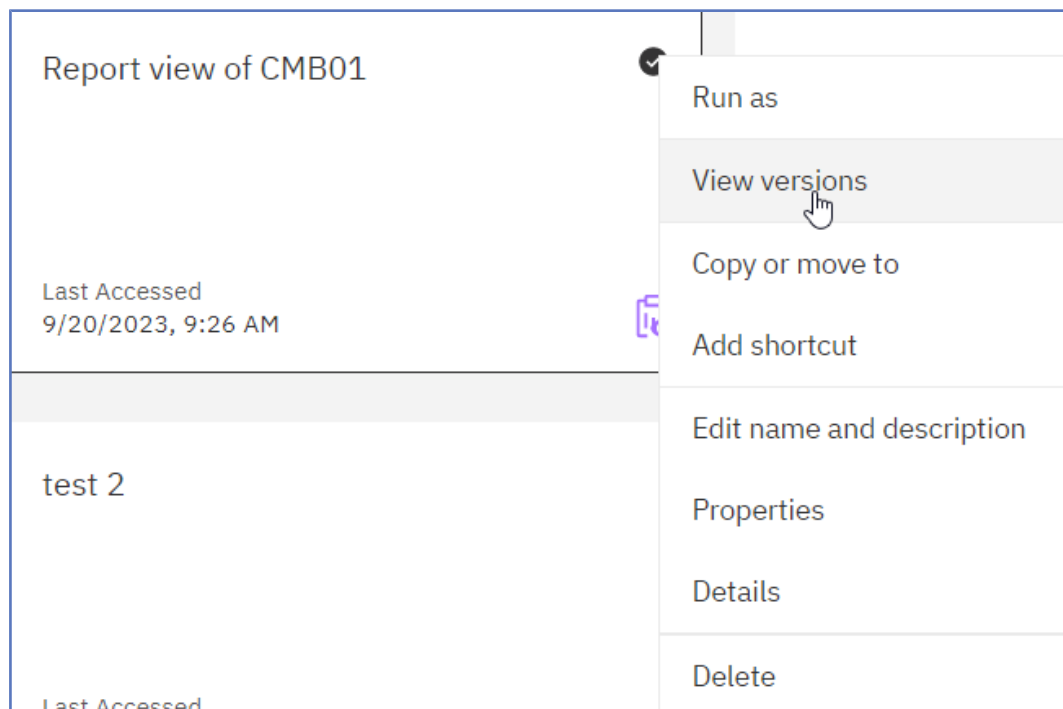

Illustration 251: My content - report view - View versions{CR-819}

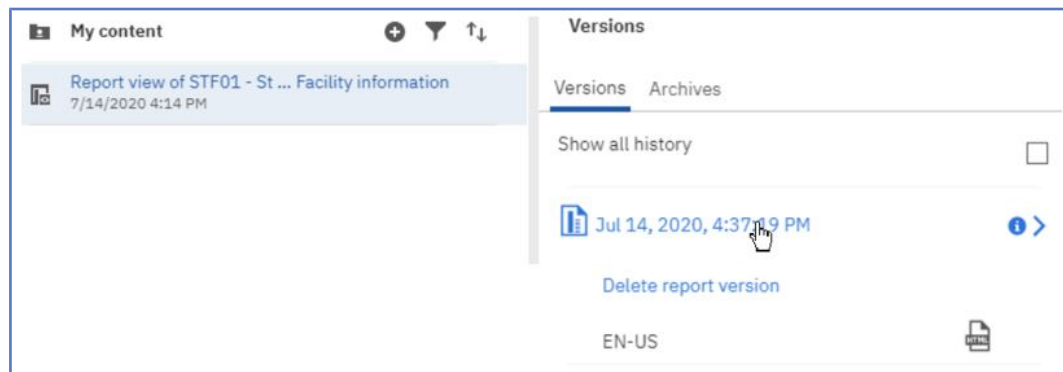



Illustration 252: **My content – report view – View versions – Version – report output** ⁵⁷ {CR-819}

⇒ By clicking on the respective version you can either delete this version or view the outcome by clicking on the “*Format*” icon.

6. **You can click on the report name and either delete this version or view the outcome by clicking on the “Format” icon () of the report.**
{CR-819}

5.4.1.4 Exporting a report to a local folder

Context of Usage Instructions

You can export a report in csv, excel, excel data, pdf and xml format. Therefore, you have to navigate to the folder of the desired report.

1. Choose the report you want to export and click on the “*More*” icon () in the right of the report name. {CR-819}
2. Select “*Run as*” from the list.

57 **This content is not applicable as of R6.2, and will become applicable upon the deployment of the Data Warehouse for T2S.**
{CR-819}

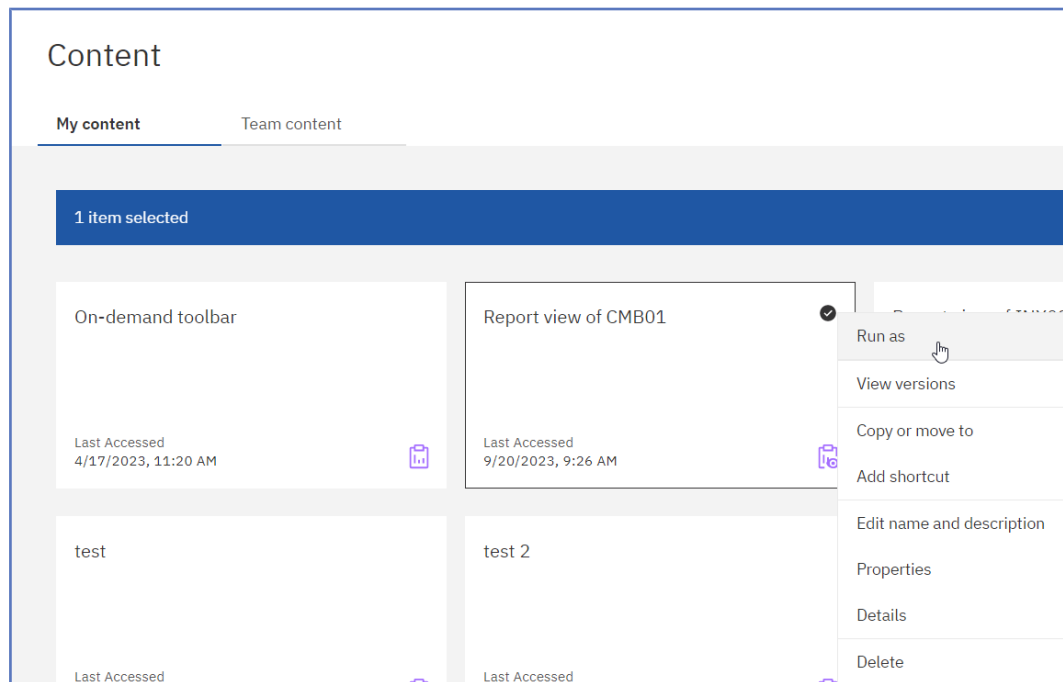

Illustration 253: Welcome page - My content - Properties{CR-819}

3. Select the desired format and enter the selection criteria of the report (see chapter Run a report step-by-step [► 936]).
4. After clicking on the “Run” button a pop-up window appears to save the report. You can download a report in csv, excel, excel data, pdf and xml format.
5. **The download option depends on the chosen format and the functionality of the browser you are using. In most browsers you can define, whether certain file types should be opened in the browser, a save dialog is shown or the file is directly downloaded to the default download directory. Please be aware that these settings have to be done in the browser, not in the DWH GUI.**
For example, if you choose to run the report as ‘XML’, then you cannot view the result, but only download the report in a local folder.{CR-819}



Hint

~~The download option depends on the chosen format and the functionality of the browser you are using. In most browsers you can define, whether certain file types should be opened in the browser, a save dialog is shown or the file is directly downloaded to the default download directory. Be aware that these settings have to be done in the browser, not in the DWH GUI.~~

~~For example, if you choose to run the report as ‘XML’, then you cannot view the result, but only download the report in a local folder.{CR-819}~~

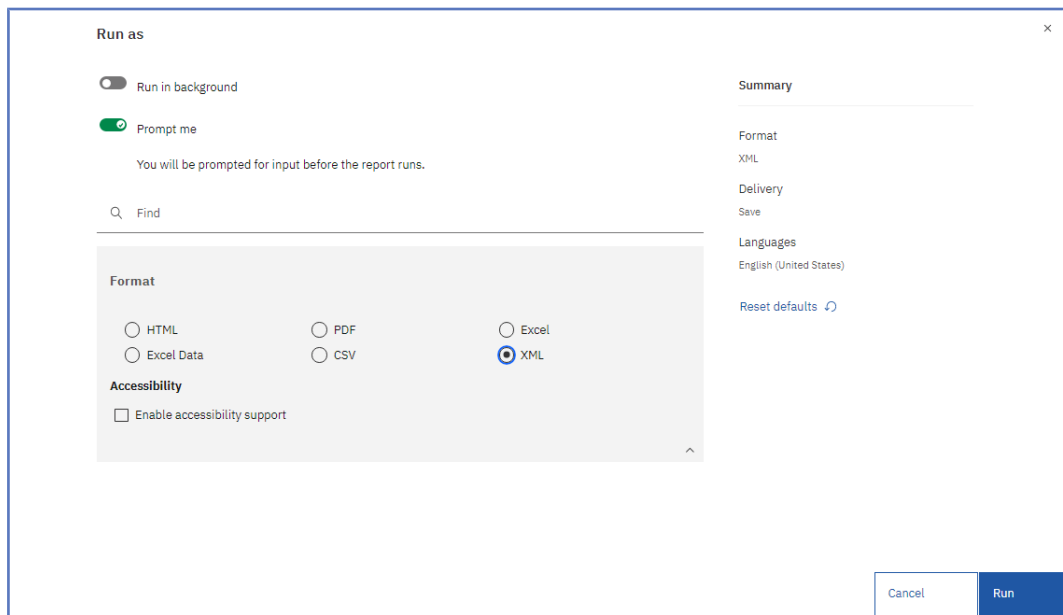

Illustration 254: **Welcome page - My content – Properties-Run as XML**{CR-819}

6. A pop up window appears to save the report:

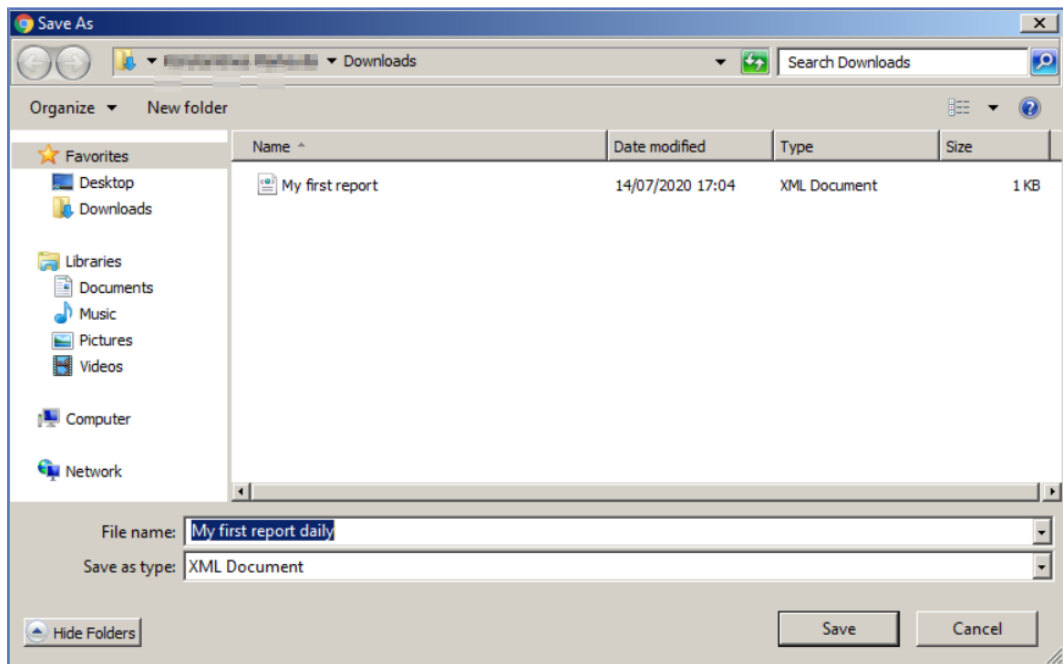

Illustration 255: **Save report on local device**⁵⁸{CR-819}

5.4.2 Running reports

This chapter gives you an overview about how to run a report and organise its delivery.⁵⁹

58 **This content is not applicable as of R6.2, and will become applicable upon the deployment of the Data Warehouse for T2S.** {CR-819}

59 This content is not applicable as of R6.2, and will become applicable upon the deployment of the Data Warehouse for T2S.

5.4.2.1 Run a report step-by-step

Instructions

1. Navigate to the **“Team content”** >> **folder, click on “T2S” there to folder “Predefined Report”** and open the folder with the desired report. **{CR-819}**

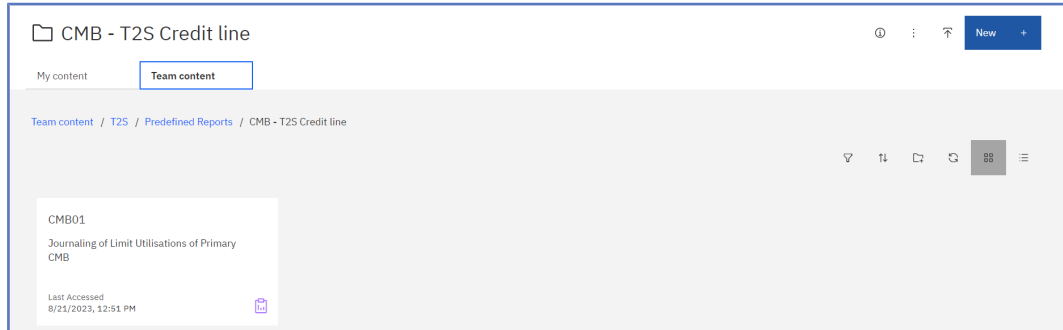

Illustration 256: Team content – T2S - Predefined Reports – CMB - T2S Credit line {CR-819}

2. Select the report you want to run. In order to run the report you can click on the report name. This action will run the report in the default DWH format, which is html.

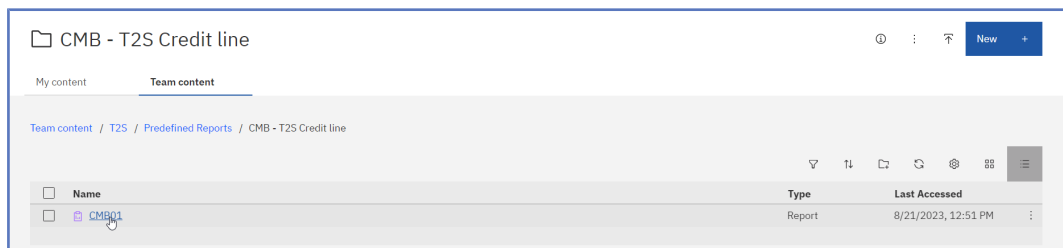

Illustration 257: Team content – T2S - Predefined reports – CMB – T2S Credit line –STF– Standing Facilities Reports {CR-819}

3. In the following screen you have to enter the search criteria in the prompt page.

CMB01 - Journaling of limit utilisations of primary CMB

Date from: *

Date to: *

Currency: *

Party BIC:

Keywords:

Please search and select the party BIC

Select all

No Results

Starts with any of these keywords

Case Insensitive

[Select all](#) [Deselect all](#)

T2S CB-DCA number:

Keywords:

Please search and select the T2S DCA number

Select all

No Results

Starts with any of these keywords

Case Insensitive

[Select all](#) [Deselect all](#)

Illustration 258: Standing Facilities Reports – STF01 Standing Facility information CMB01 - T2S Credit line Report – prompt page{CR-819}

4. The report result is available in html format. ⁶⁰

60 This content is not applicable as of R6.2, and will become applicable upon the deployment of the Data Warehouse for T2S.

5.4.2.1.1 Choose different formats

Instructions

1. If you want to run the report and DWH shall provide the result in another format than html you have to click on the “More” icon () on the right side. **{CR-819}**

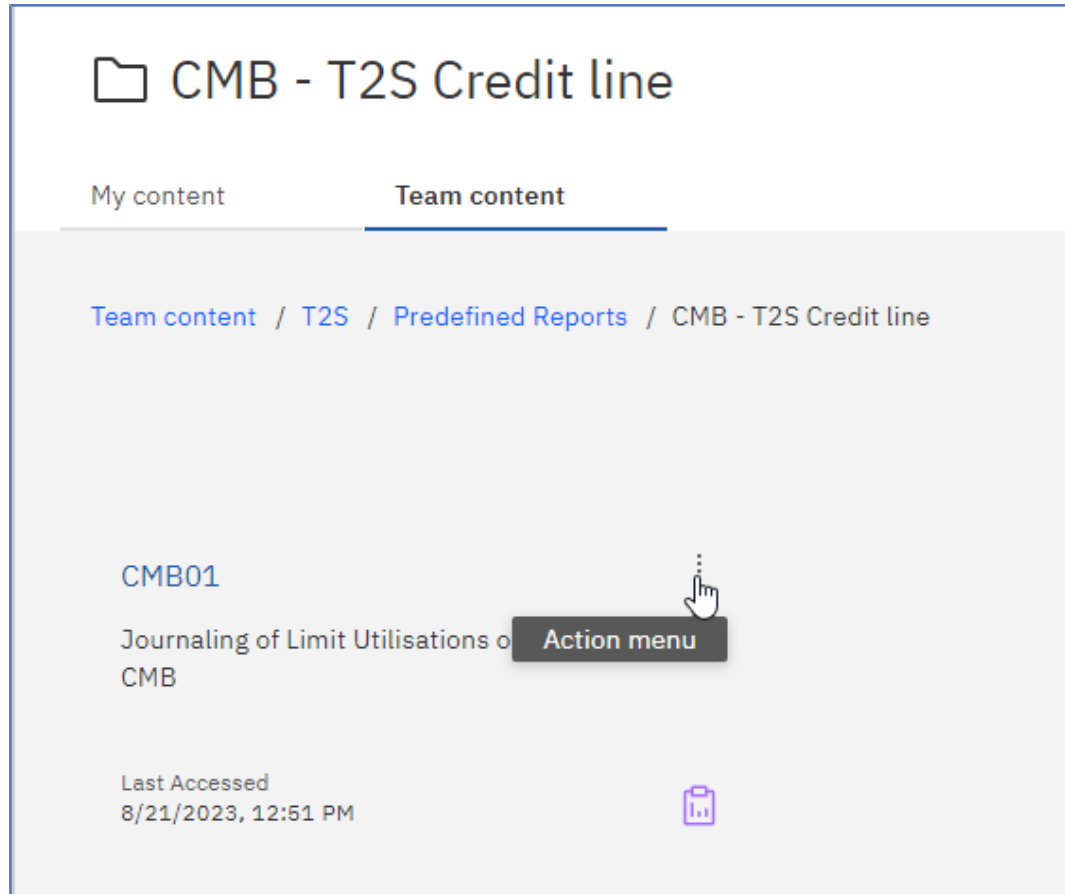

*Illustration 259: Team content – T2S - Predefined Reports – CMB01 – T2S Credit line STF–
Standing Facilities Reports {CR-819}*

2. Select “Run as” from the list.

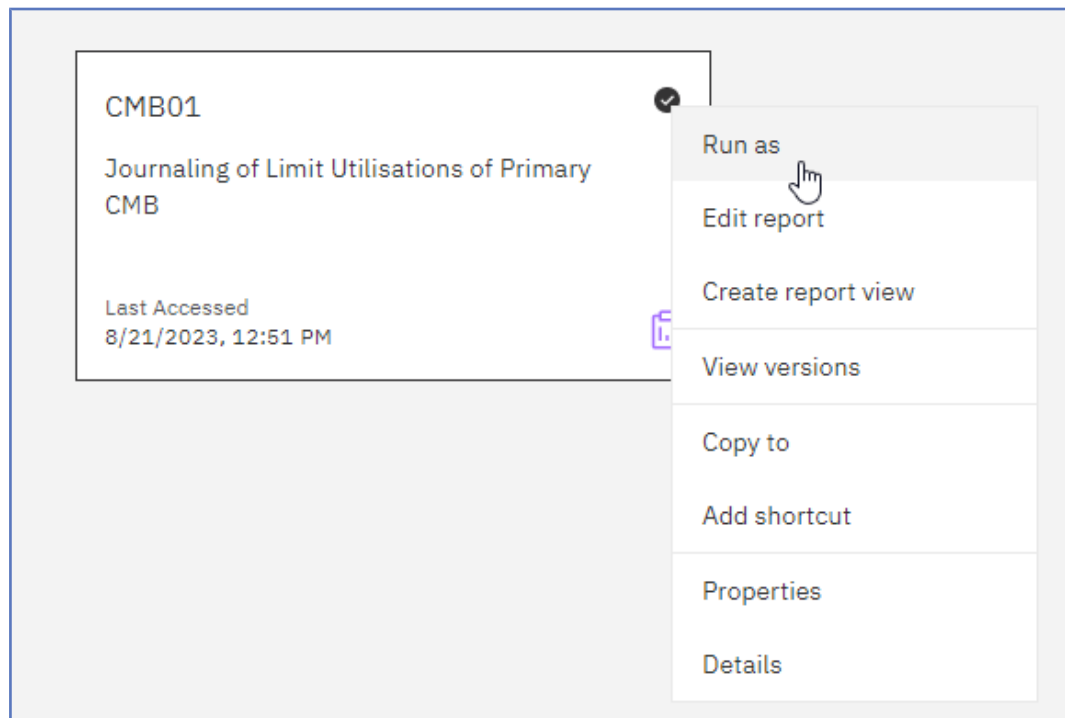

Illustration 260: Team content – T2S - Predefined Reports – CMB01 – T2S Credit line STF – Standing Facilities Reports – STF01 Standing Facility information – Run as (1){CR-819}

3. You can choose the format you want to receive the report result and click on “Run” button.

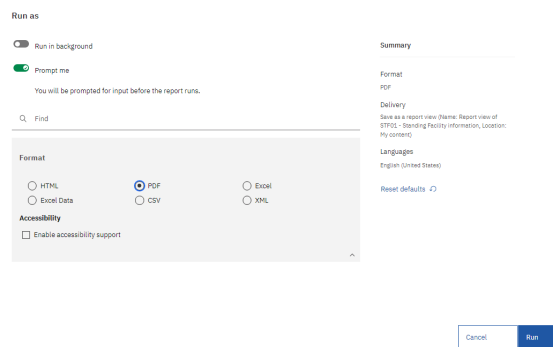

Illustration 261: Team content – T2S - Predefined Reports – CMB01 – T2S Credit line Report STF – Standing Facilities Reports – STF01 Standing Facility information – Run as (2) {CR-819}

4. Also with a different format you have to enter the search criteria in the prompt page.

CMB01 - Journaling of limit utilisations of primary CMB

Date from: *

Date to: *

Currency: *

Party BIC:

Keywords:

Select all

No Results

Starts with any of these keywords

Case Insensitive

Please search and select the party BIC

Select all Deselect all

T2S CB-DCA number:

Keywords:

Select all

No Results

Starts with any of these keywords

Case Insensitive

Please search and select the T2S DCA number

Select all Deselect all

Illustration 262: Standing Facilities Reports – STF01 Standing Facility information CMB01 - T2S Credit line Report - prompt page{CR-819}

5. The report result is available in the chosen format, in this example in pdf format.⁶¹

⁶¹ This content is not applicable as of R6.2, and will become applicable upon the deployment of the Data Warehouse for T2S.

5.4.2.1.2 Run in background

Instructions

1. There is another option to run a report – “Run in background”. You can find and select this option under “Run as”.

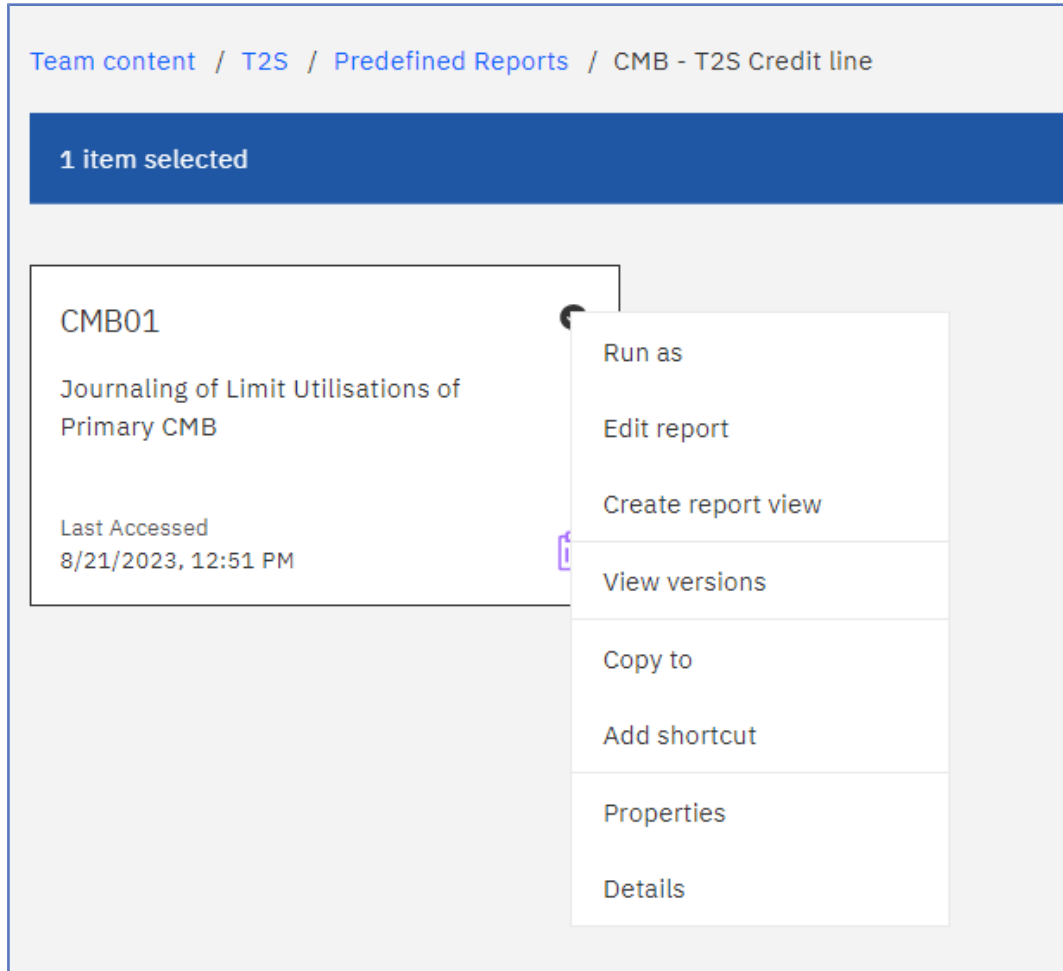

Illustration 263: Team content – T2S - Predefined Reports – CMB T2S Credit line – CMB01 – STF – Standing Facilities Reports – STF01 Standing Facility information – Run as {CR-819}

Here you can see the “Run in background” option on top of the list.

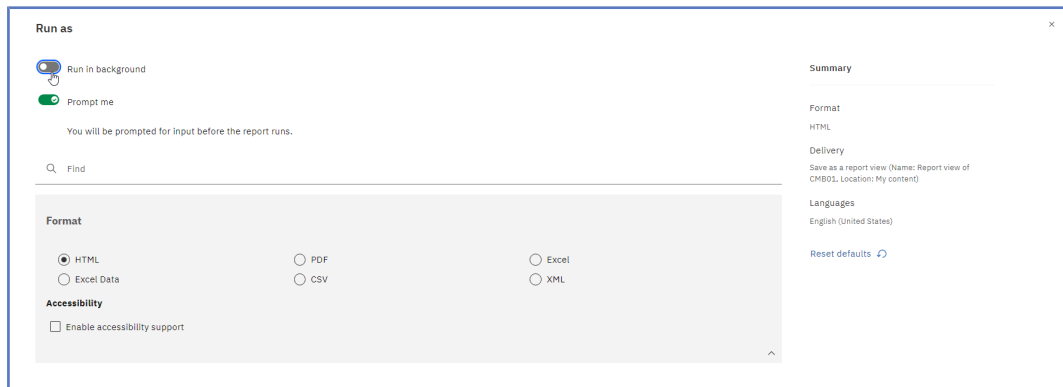

Illustration 264: Team content – T2S - Predefined Reports – CMB – T2S Credit line STF – Standing Facilities Reports – STF01 Standing Facility information – Run as – Run in background{CR-819}

- This option gives you the opportunity to run the report in the background without waiting for the result. Instead, you can view the report when the report is available.
- In order to run the report in background, you have to enable “Run in background”. The icon colour turns into **bluegreen**, meaning this option is enabled, and the following options are available to you:{CR-819}

Run as

Run in background

Now

Later

Show Run history details window after you click Run

Illustration 265: Run as – Run in background – Advanced Options{CR-819}

- When you select “Prompt me”, you have to enter search criteria in the prompt page after you click on the “Run” button. If you don’t chose this, the report will run with the last set of search criteria you have used.
- You can decide if you want to run the report now or later. You can find this option by clicking on the arrow to the right of the “Advanced” section.

In case you select “Now”, the report runs directly. A message on top informs you that the prompt page will open.{CR-819}

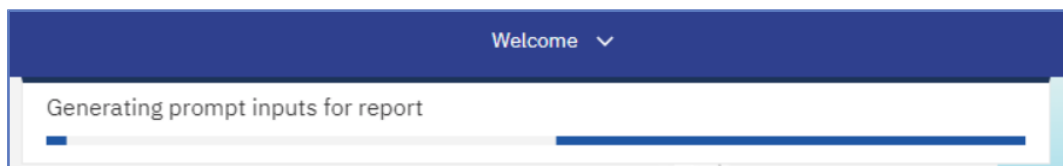

Illustration 266: Run as – Run in background – Advanced {CR-819}

- In case you select “Later”, you can choose the date and time of the execution.

Run as

Run in background

Now

Later 2023-09-13 📅 9:30 AM

Illustration 267: Run as – Run in background – Advanced – Execution time Options – Later {CR-819}

5.4.2.2 Delivery

Delivery options

~~You can deliver reports by either saving them on the “Team content folders”, or by saving them as an external file. You have two possibilities to deliver a report result if you want to receive the result only once. First you can save the report in DWH directly and view it after successful creation. The second option is the delivery to the application of your party.~~

Scheduling reports

In case a report should be delivered to you (independent from the output channel (U2A or A2A) you **have to run the report in the background or** schedule a report. For this option refer to chapter Scheduling reports [▶ 953] for further details.
⁶³{CR-819}

5.4.2.2.1 Delivery - Save the report for an external file (U2A)

Instructions

- ✓ ~~To save the report result you must click on the arrow on the right of the “Delivery” section. Choose “Save report” and click on the “Done” button. As soon as it is executed, the report is saved in DWH.~~
- 1. ~~Navigate to the respective report folder.~~{CR-819}
- 2. Click on the “More” icon at the right of the report and select “Run as”.

63 This content is not applicable as of R6.2, and will become applicable upon the deployment of the Data Warehouse for T2S.

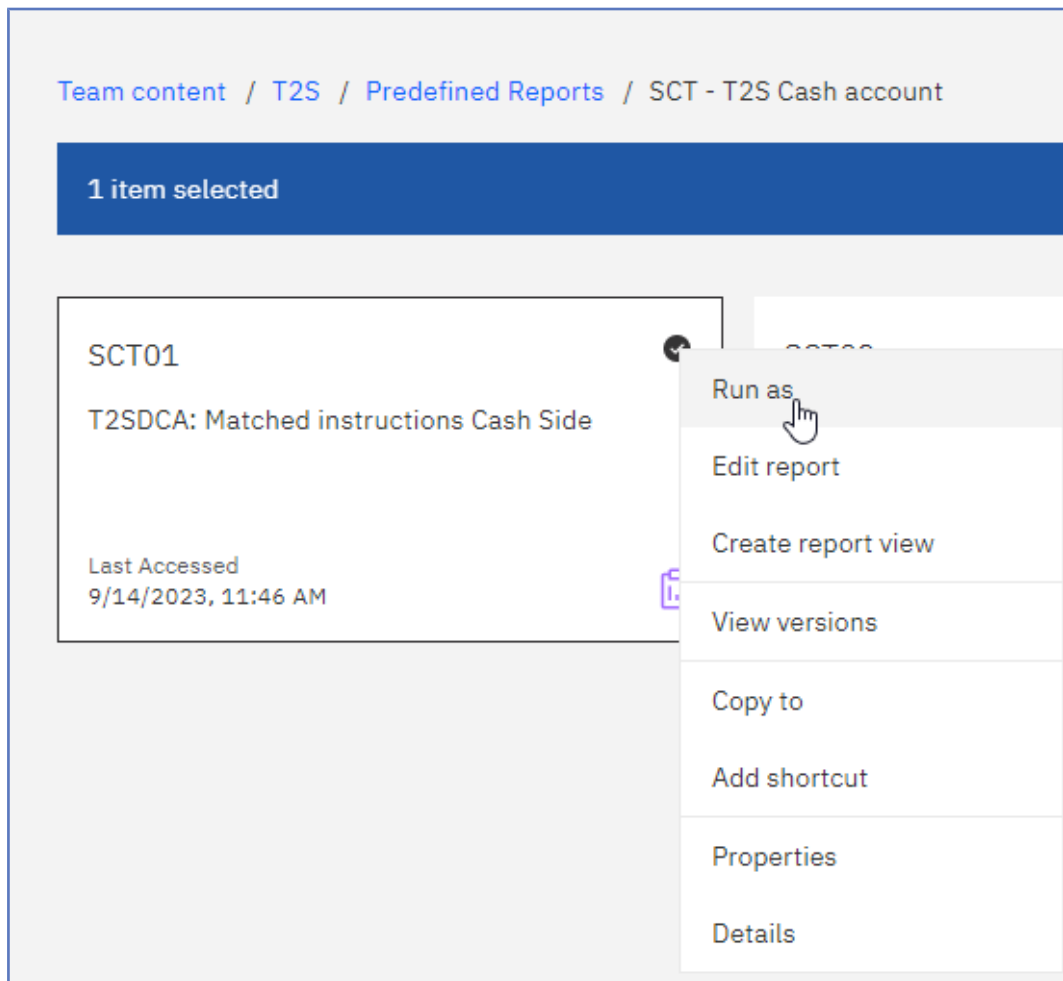

Illustration 268: Team content – T2S - Predefined Reports – SCT - T2S Cash account – SCT01 – STF – Standing Facilities Reports – Run as (CR-819)

3. Select “Run in background”.

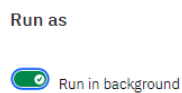

Illustration 269: Team content – T2S - Predefined Reports – SCT – T2S Cash account - SCT01 - STF – Standing Facilities Reports – Run as – Run in background (CR-819)

4. **Click the arrow next Scroll down to “Advanced” to view the delivery section.**

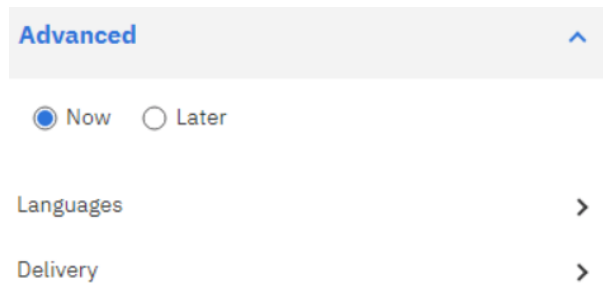

Illustration 270: Team content – Predefined Reports – STF – Standing Facilities Reports – Run as – Run in background – Advanced{CR-819}

5. Click the arrow next to the “Delivery” property, uncheck the “Print report” property, and echeck the “Save report as an external file”. Finally, click on “DoneRun”.{CR-819}

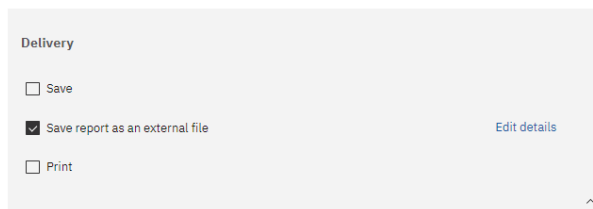

Illustration 271: Team content – T2S - SCT - T2S Cash account – SCT01 Predefined Reports – STF – Standing Facilities Reports – Run as – Run in background – Advanced Delivery – Save report as an external file ⁶⁴{CR-819}

5.4.2.2.2 Delivery - Save the report for an external file (A2A)

For the A2A delivery please follow the steps described hereafter.

Instructions

1. You navigate to the respective report folder as described in chapter Copy a report [▶ 926].

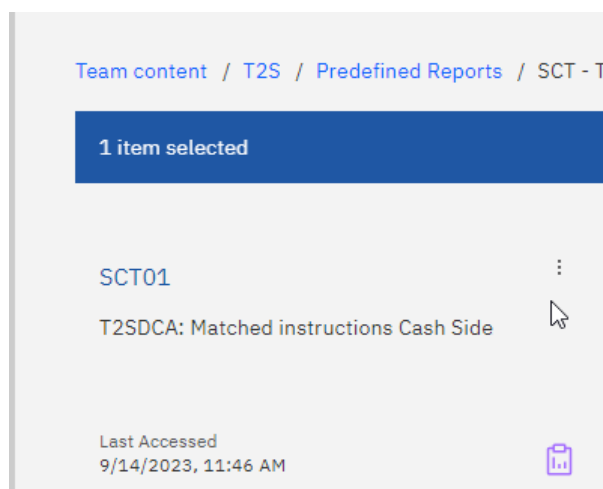



Illustration 272: Team content – T2S - Predefined reports – SCT - T2S Cash account – SCT01{CR-819}

64 This content is not applicable as of R6.2, and will become applicable upon the deployment of the Data Warehouse for T2S.

- Click on the “**More Action menu**” icon () at the right of the report and select “**Copy to**” or “**Create report view**”.

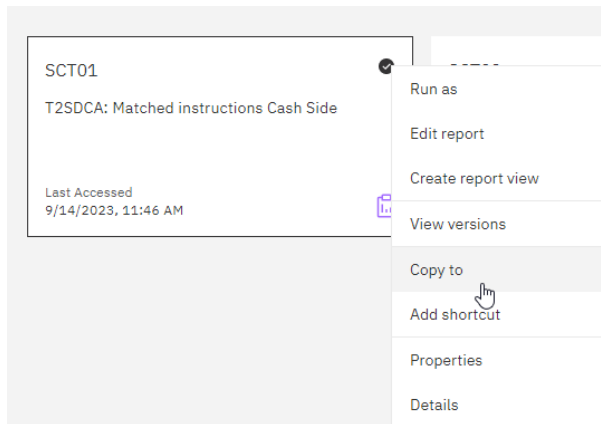

Illustration 273: STF01 Standing Facility information – More options SCT01 -T2S Cash account - Action menu{CR-819}

- A window pops up where you have to enter a storage location for your copy or report view. In this example, the report is copied to “*My content*”.
- {CR-819}**

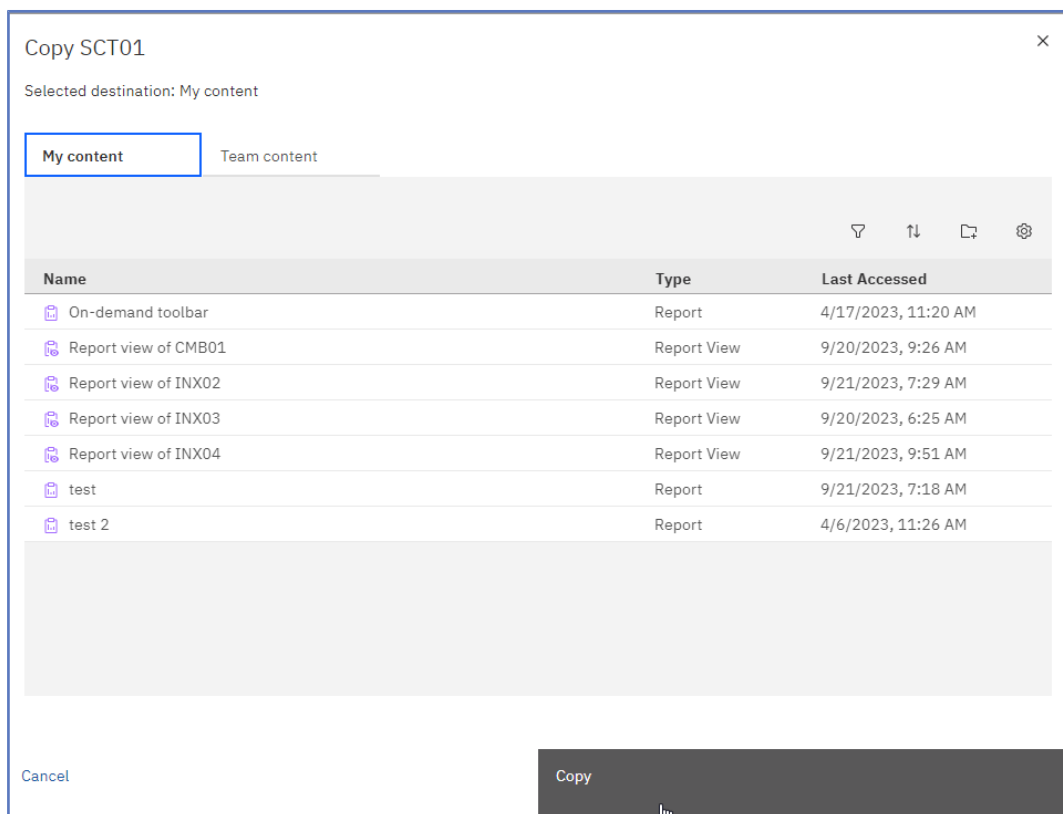

Illustration 274: STF01 Standing Facility information SCT01 -T2S Cash account - Copy{CR-819}

- Navigate to the folder where you have copied the report. In this example, the folder is “*My content*”.

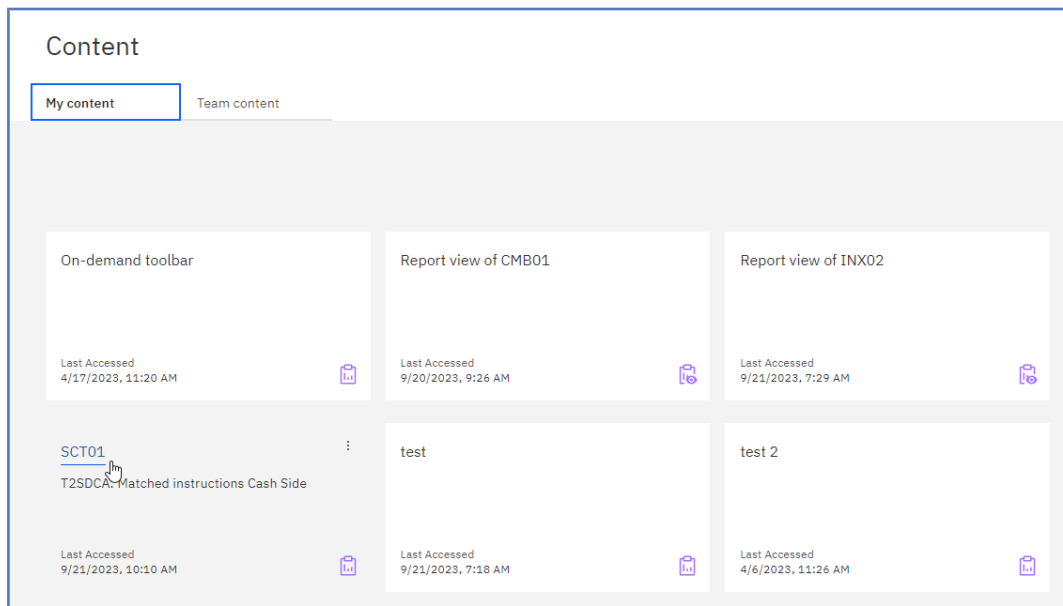

Illustration 275: ~~STF01 Standing Facility information~~ SCT01 - T2S Cash account – Copy to My content{CR-819}

5. Find the report and click on the “More” icon at the right of the report and confirm by clicking “Run as”.

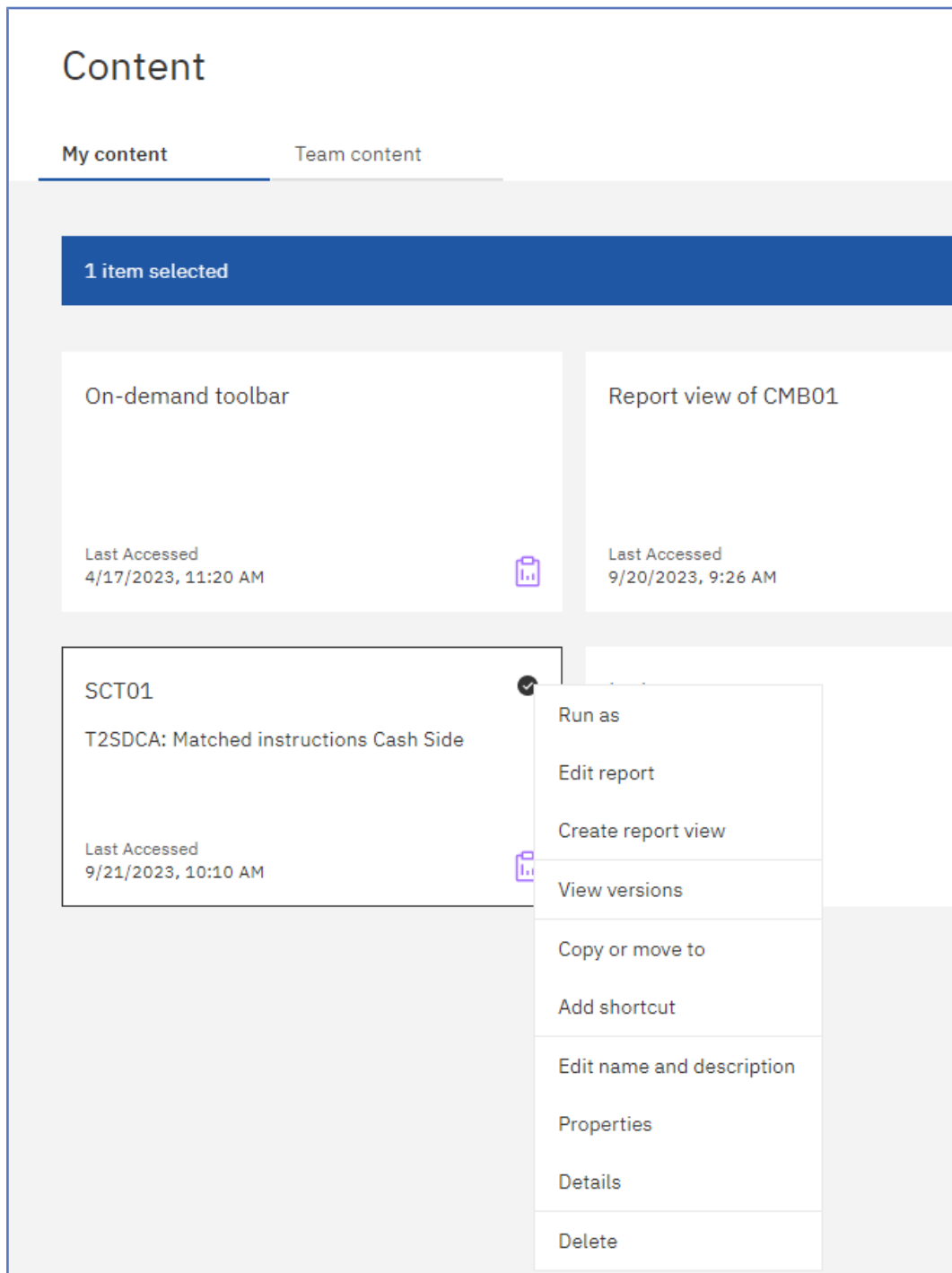

Illustration 276: **My content – STF01 Standing Facility information SCT01 - T2S Cash account - Run as{CR-819}**

6. Perform the same action as explained in chapter Run a report step-by-step [▶ 936] for “Run in background”.
7. Check the “Run in background” button:

Run as

Run in background

Illustration 277: My content - STF01 Standing Facility information SCT01 - T2S Cash account - Run as – Run in background{CR-819}

8. For delivery in A2A you can choose **any of** the **following available** formats: **csv, excel, xml.**
9. You are free to select **“Advanced”** “Now” or “Later” and add a date and time of the execution.

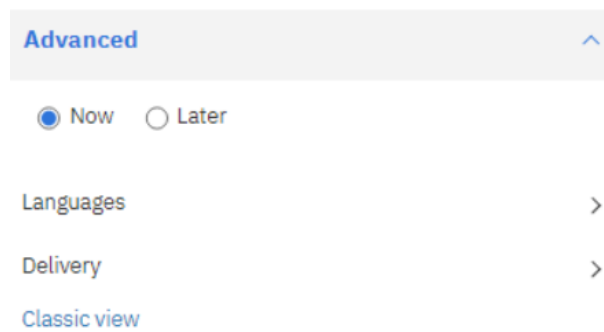

Illustration 278: My content – STF01 Standing Facility information – Run as – Advanced – Now or Later{CR-819}

10. For “Delivery” you have to select the option “Save report as an external file”.

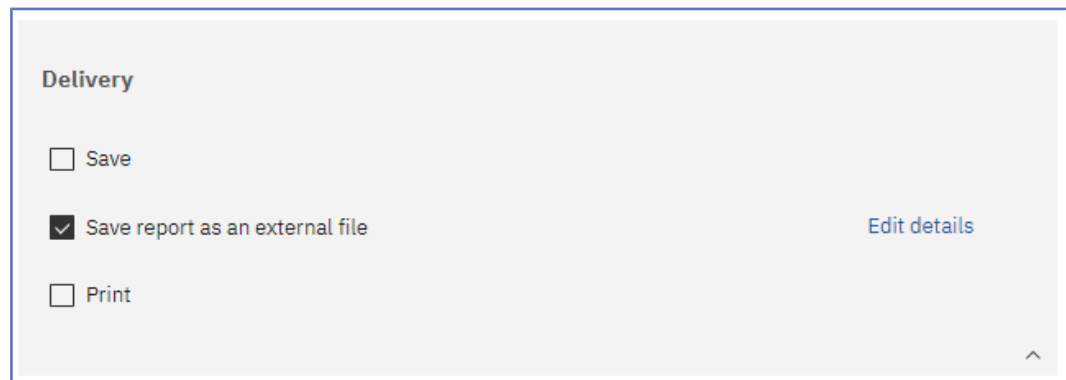

Illustration 279: My content - STF01 Standing Facility information - Run in background – Advanced Options Delivery{CR-819}

11. After you activated the “Save report as an external file” checkbox, **further options are presented** click on “Edit details”.

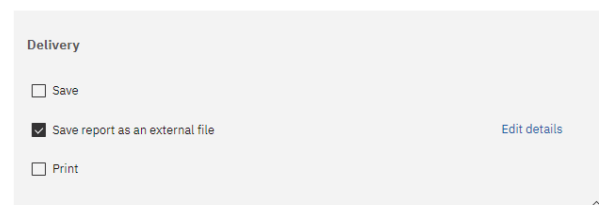

Illustration 280: My content – STC01 STF01 Standing Facility information - Run in background - Advanced Delivery - Save report as an external file{CR-819}

The “Name” field presents the name of the report. The default value is the name of the report, as it is known in DWH. **Please note, that by leaving the default name in place you need to prevent the generated file from being overwritten by a file with the same name but stemming from other users. For this, please change the value for “Conflict resolution” to one of the two following choices:**

- Make the file names unique and append a timestamp**
- Make the file names unique and append a sequence number**

← Save report as an external file

Name

SCT01

Reset name

Location

IAC-ReportOutput scheduled

Conflict resolution

- Keep existing files
- Replace existing files
- Make the file names unique and append a timestamp
- Make the file names unique and append a sequence number

Illustration 281: My content - SCT01 - Run in background - Delivery - Save report as an external file – Conflict resolution{CR-819}

Please do not change the default value in the “Location” field, as this is the place where the report is stored before it is delivered to your party via A2A. Changing the default value in the ‘Location’ field will result in reports not being sent via A2A. The folder is not accessible via the GUI and only for storing the report before it is delivered via A2A.



Hint

~~Do not change the default value in the “Location” field, as this is the place where the report is stored before it is delivered to your party via A2A. Changing the default value in the “Location” field will result in reports not being sent via A2A. The folder is not accessible via the GUI and only for storing the report before it is delivered via A2A.~~

12. Click on the “Done” button.

2. Click on the “Run” button ().{CR-819}

Run as

Run in background

Excel
 Excel Data
 PDF
 HTML
 CSV
 XML

Prompt me
 You will be prompted for input before the report runs in background.

Advanced ^

Now Later

Languages >
 Delivery >
 Classic view



Illustration 282: ~~My content – STF01 Standing Facility information – Run in background – Advanced Delivery – Run the report~~{CR-819}

3. Enter the search criteria in the prompt page.

SCT01 – T2S DCA – Finalised matched instructions cash side – Prompt

Date from: *

Date to: *

Currency: *

Party BIC:

Keywords:

Please search and select the party BIC

Select all

No Results

→

←

Case Insensitive

T2S DCA number:

Keywords:

Please search and select the T2S DCA number

Select all

No Results

→

←

Case Insensitive

[Select all](#) [Deselect all](#)

[Select all](#) [Deselect all](#)

Illustration 283: My content - SCT01 STF01 Standing Facility information - Run in background - Advanced Delivery – Enter search criteria{CR-819}

4. Click on the “Finish” button.

The report will be executed and the result will be sent via A2A in the chosen format to your party.

Or you run your report in the background with the delivery “Save the report as an external file”.⁶⁵

65 This content is not applicable as of R6.2, and will become applicable upon the deployment of the Data Warehouse for T2S.

5.4.3 Scheduling reports

5.4.3.1 Scheduling the report for a specific time

Context of Usage

The DWH offers a scheduler function, which allows the configuration and delivery of (recurring) reports with individual settings.

This chapter describes the steps that you perform to schedule a report and to check the scheduling afterwards.

After saving the report in “*My content*” or, for CB/CSD users, under the shared folder of your CB/CSD, you have to choose the report you want to schedule and create a report view of this report (see chapter Saving a report output [▶ 932]).

After creating the report view you can start to schedule your report.

Instructions

1. Choose the report you have saved as a report view, and click on the “**More-Action menu**” () icon at the right of the report. **{CR-819}**
2. Click on “*Properties*”.

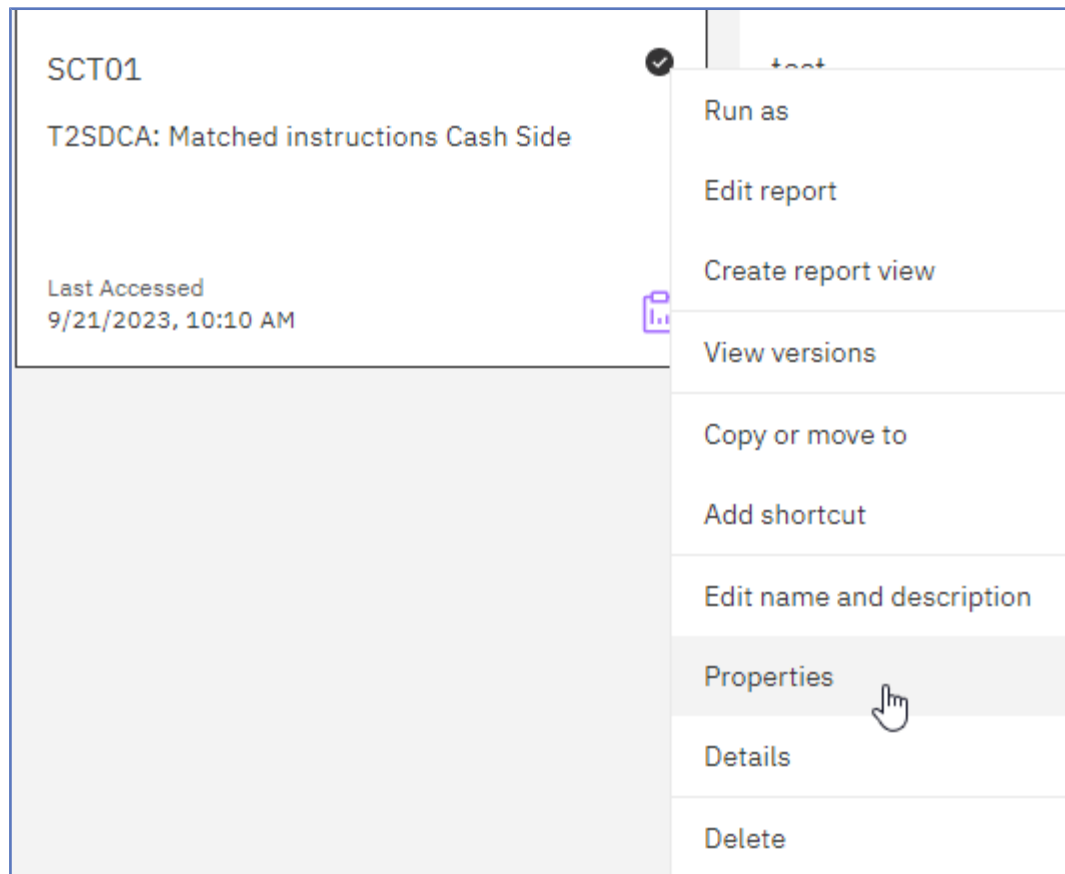

Illustration 284: **My content - report view - Properties**{CR-819}

3. A description of your report is shown and you can add a description under “*General*”.

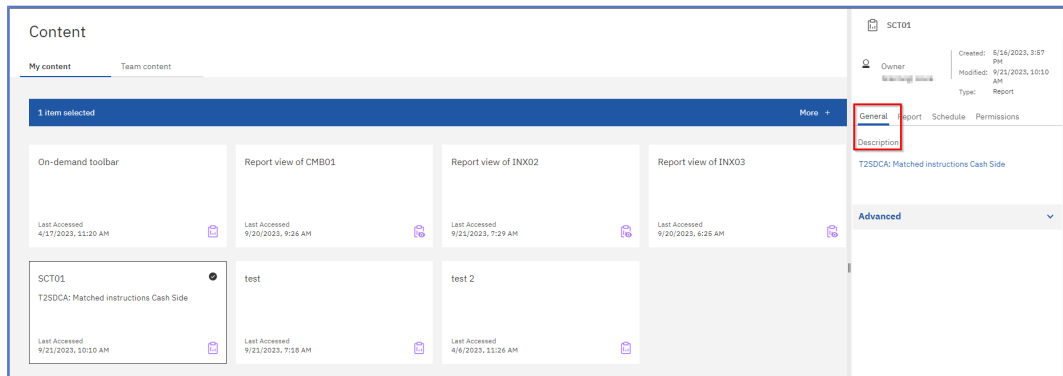
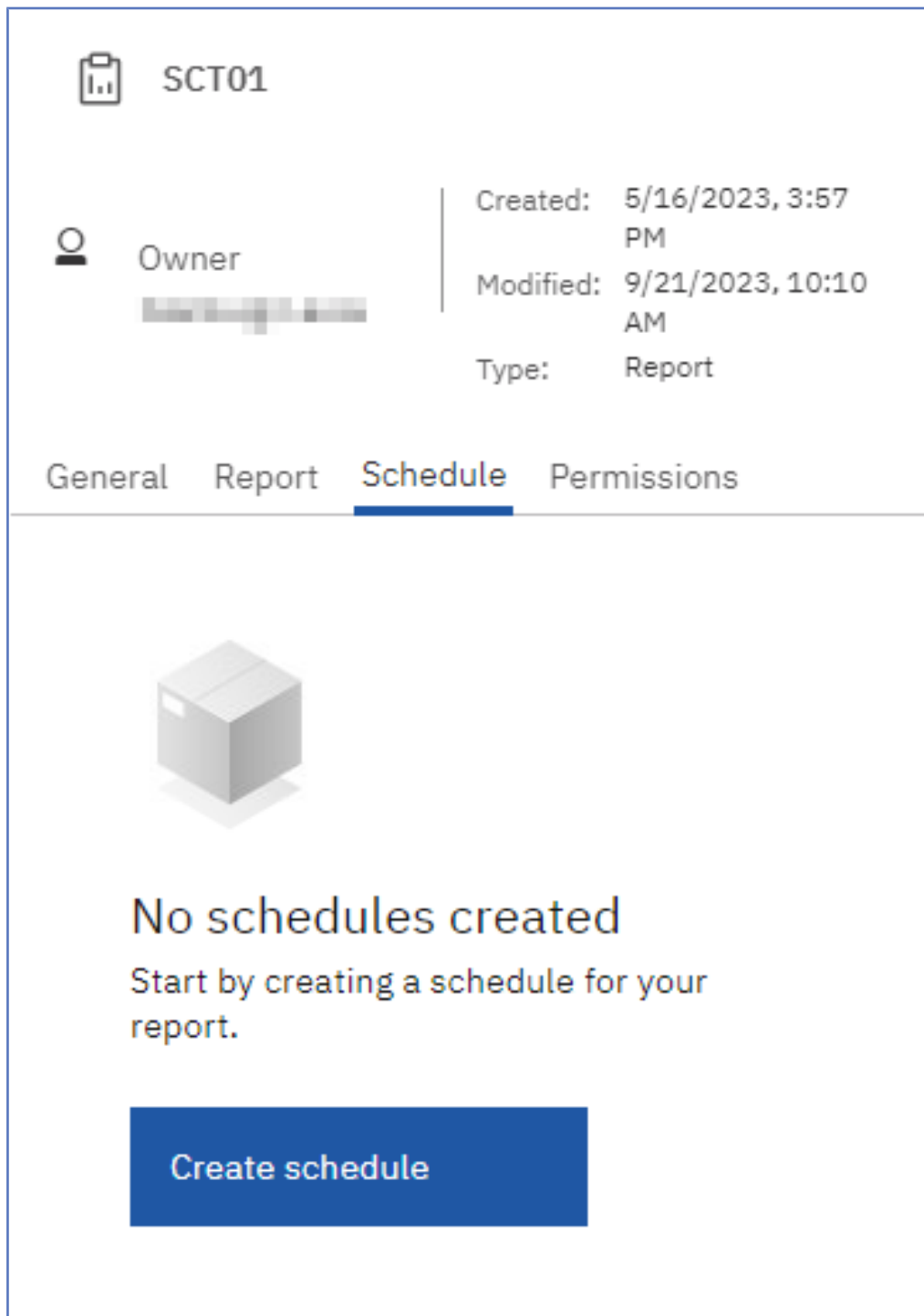

Illustration 285: My content - report view - Properties – General - description of your report{CR-819}

4. In the “Schedule” tab you will find the “**NewCreate schedule**” icon.



SCT01

Owner: [Redacted]

Created: 5/16/2023, 3:57 PM
Modified: 9/21/2023, 10:10 AM
Type: Report

General Report **Schedule** Permissions

No schedules created

Start by creating a schedule for your report.

[Create schedule](#)

Illustration 286: **Welcome page - My content - report view - Properties - Schedule**{CR-819}

5. By clicking on the “[New Create schedule](#)” icon, the “Schedule” is opening where you have multiple options to choose for scheduling your report.
{CR-819}
6. You can set a variety of options when scheduling a report: the frequency the report will be run, the “Period” of the schedule, the format in which the report will be delivered, and the delivery method.

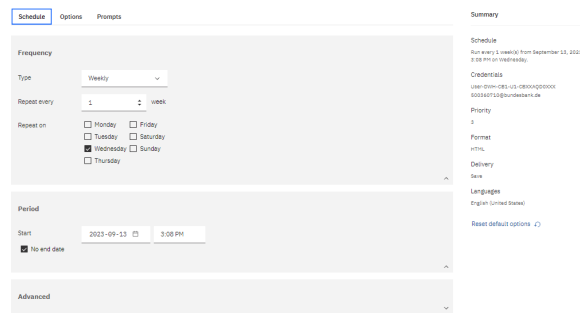

Illustration 287: Welcome page - My content - report view - Properties - create schedule (2) {CR-819}

The following options are mandatory for scheduling. Please note, that especially the prompt values have to be set, otherwise the report will not be generated.

Schedule: The frequency, which the report will be run, daily, weekly, monthly, yearly.

Period: Choose the start and the end date of the schedule. Alternatively, by clicking on “No end date” the schedule will run indefinitely.

Format: The type of format the report will be executed to, HTML, csv, excel, excel data and xml. For further information, you may check the chapter Run a report step-by-step [▶ 936].

Delivery: You may choose if you want to save the report in Cognos or as an external file. For further information go to chapter Delivery - Save the report for an external file (U2A) [▶ 943].

Prompts: By clicking on “Set values”, and then “Set” you will be presented with the prompt page of the report, where you have to enter the selection criteria.

Languages: Since the only language in the database is English, nothing will change in case you define another language.

PDF: By clicking on “Select” you may choose the orientation or the paper size.

In this example, you see a daily schedule with no end date, HTML as an output, and save the report in DWH.

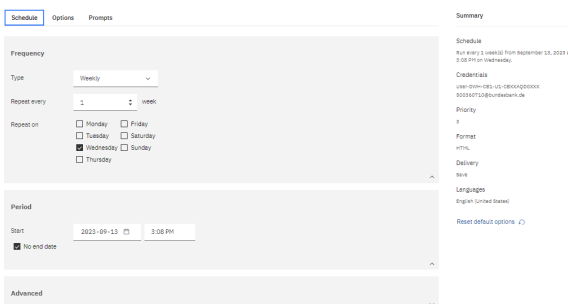

Illustration 288: Welcome page - My content - report view - Properties - create schedule (3) {CR-819}

In case you want to receive the scheduled reports via A2A you have to choose “*Delivery - Save report as external file*” and follow the information provided in chapter *Delivery - Save the report for an external file (U2A)* [▶ 943].

Instructions

7. After you have entered all mandatory information, click on the “**CreateSave**” button and the schedule is created. **{CR-819}**



Illustration 289: **Welcome page - My content - Properties – Schedule**{CR-819}

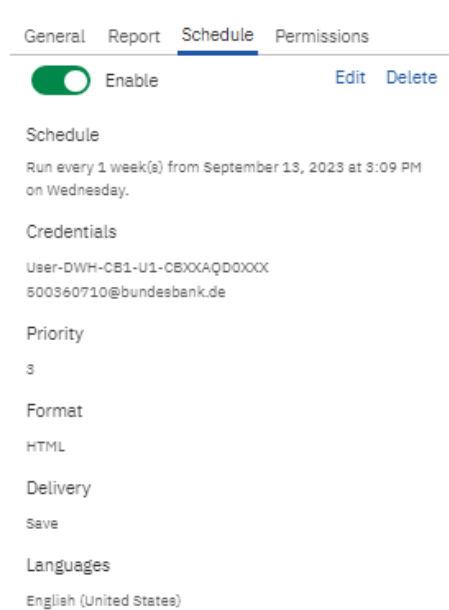

Illustration 290: **Welcome page - My content - Properties – Schedule**{CR-819}

The option “*Enable*” informs the user that the schedule is active. By unchecking it, the user cancels the schedule. ⁶⁶

5.4.3.2 Scheduling the report for a specific DWH event

Context of Usage

You can also schedule a report to be executed shortly after the new data of the last business day was loaded into the DWH. One dedicated DWH internal event will be triggered that starts the execution of the report and either stores it in the “*My content*” folder or sends it out via A2A.

Instructions

1. Choose the report you have saved as report view, and click on the “**MoreAction menu**” () icon at the right of the report. **{CR-819}**
2. Click on “*Properties*”.

66 This content is not applicable as of R6.2, and will become applicable upon the deployment of the Data Warehouse for T2S.

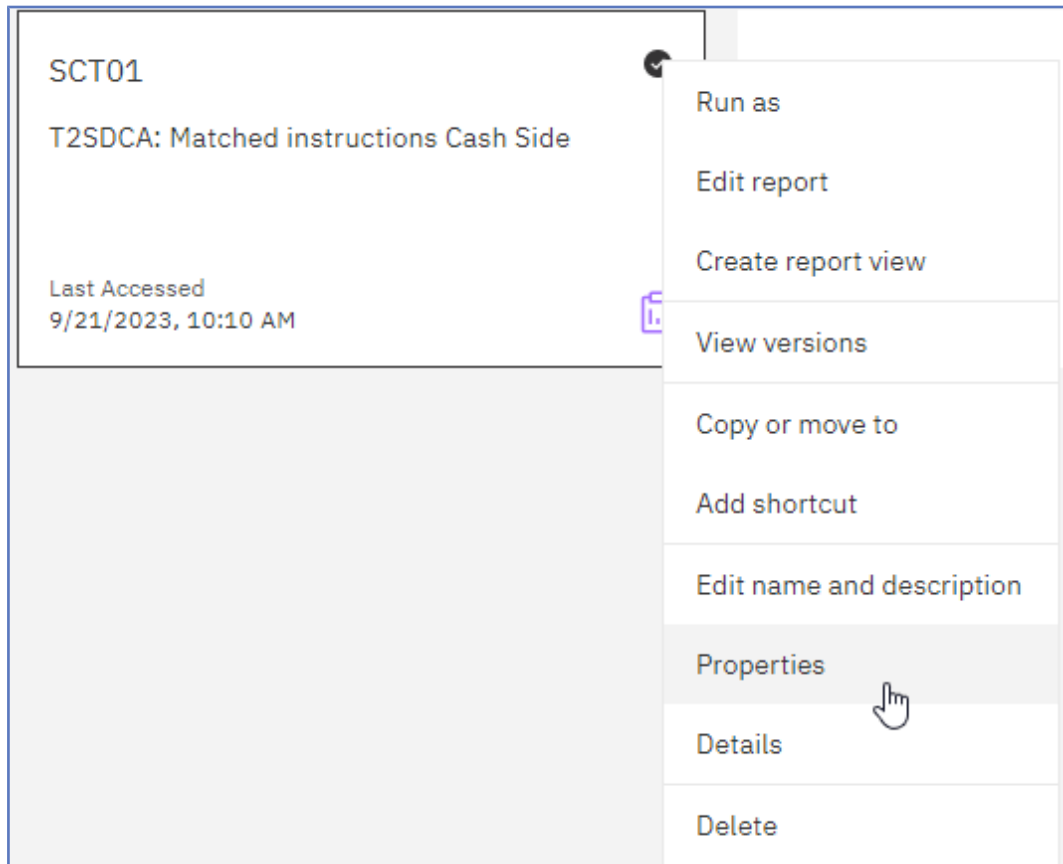

Illustration 291: My content - report view – Properties{CR-819}

3. A description of your report is shown and you can add a description under “General”.

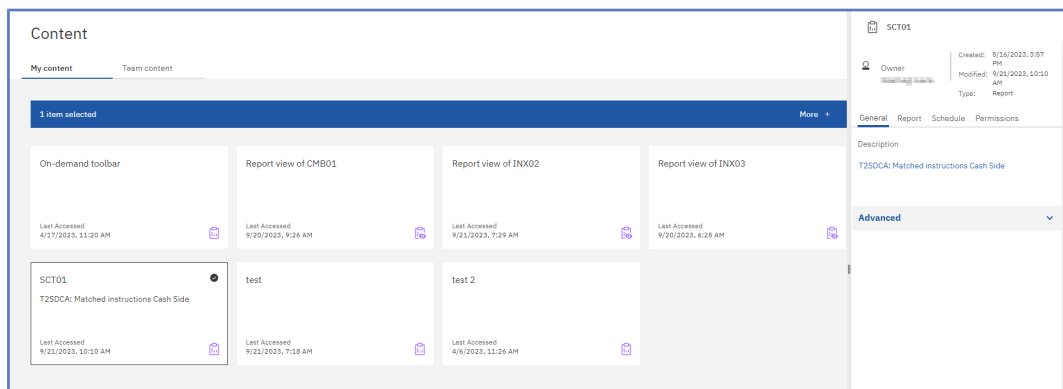

Illustration 292: My content - report view - Properties – General - description of your report{CR-819}

4. In the “Schedule” tab you will find the “New Create schedule” icon.

The screenshot displays the 'Schedule' tab for a report named 'SCT01'. At the top, there is a report icon and the name 'SCT01'. Below this, the 'Owner' is listed as 'Owner' with a blurred name. To the right, the report's metadata is shown: 'Created: 5/16/2023, 3:57 PM', 'Modified: 9/21/2023, 10:10 AM', and 'Type: Report'. A navigation bar at the bottom of the header includes 'General', 'Report', 'Schedule' (which is underlined), and 'Permissions'. The main content area features a large 3D box icon, the text 'No schedules created', and a sub-message: 'Start by creating a schedule for your report.' A prominent blue button labeled 'Create schedule' is positioned at the bottom of the content area.

Illustration 293: **Welcome page - My content - report view - Properties – Schedule**{CR-819}

5. By clicking on the “**New**Create schedule” icon, the “Schedule” is opening where you have multiple options to choose for scheduling your report.
{CR-819}

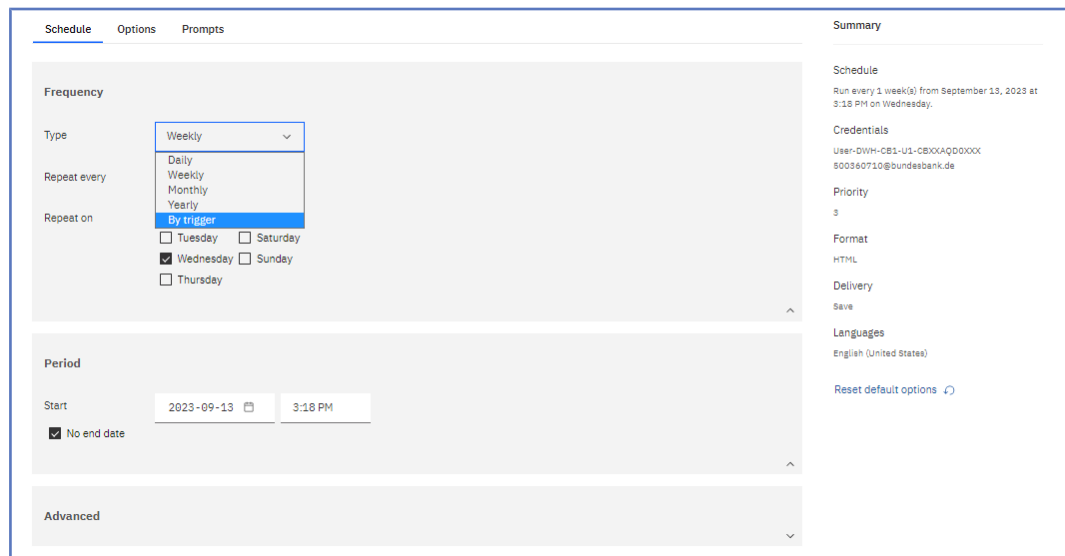

Illustration 294: Welcome page - My content - report view - Properties - create schedule (1) {CR-819}

6. Select “By Trigger” in the pull down list as schedule. In the field “Trigger name” you have to enter the phrase “eodtrigger”. Make sure to type this phrase exactly this way, otherwise the report trigger does not work and the scheduled report will not be executed.

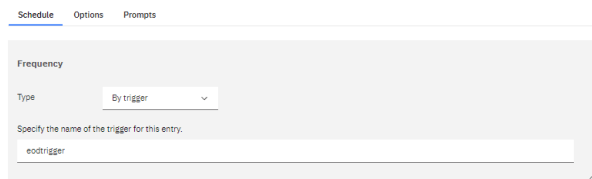

Illustration 295: Welcome page - My content - report view - Properties - create schedule (2) {CR-819}

**Hint**

In this example, you see a daily schedule with no end date, xml as an output, and save the report in DWH.

**Welcome page – My content – report view – Properties – create schedule (3)
{CR-819}**

**Hint**

In case you want to receive the scheduled reports via A2A you have to choose “Save report as external file” and follow the information provided in chapter Delivery – Save the report for an external file (U2A).{CR-819}

7. In this example you see a trigger schedule with no end date, xml as an output and save the report in DWH

Summary**Schedule**

Run schedule on specified trigger from September 13, 2023 at 3:18 PM.

Credentials

User-DWH-CB1-U1-CBXXAQD0XXXX
500360710@bundesbank.de

Priority

3

Format

XML

Delivery

Save

Languages

English (United States)

[Reset default options](#) ↻

Illustration 296: Welcome page - My content - report view - Properties - create schedule{CR-819}

- 2. In case you want to receive the scheduled reports via A2A you have to choose “Save report as external file” and follow the information provided in chapter Delivery - Save the report for an external file (U2A) [▶ 943]. {CR-819}**
- 3. It is very important to set the prompt values when scheduling a report to be executed. This can be done by clicking on the arrow next to “Set values”.**

Schedule Options **Prompts**



You currently have no prompt values

[Set values](#)

Illustration 297: Welcome page - My content - Properties - Set values{CR-819}

- 4. The “Current values” opens. To enter the prompt page you must click on the “Set” icon.{CR-819}**

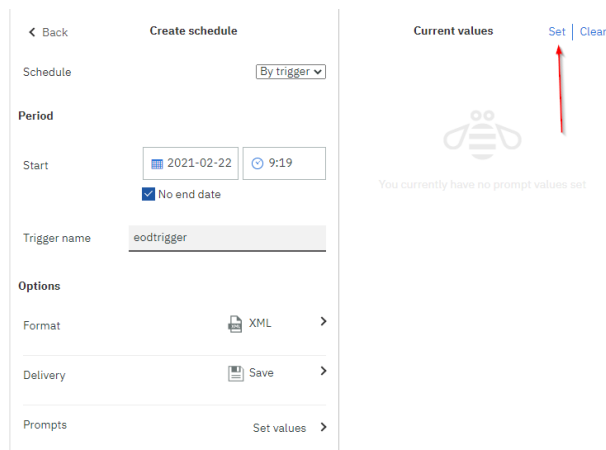

Illustration 298: **Welcome page – My content – Properties – Prompts – Set values**{CR-818}

5. Enter the search criteria on the prompt page and click on “Finish”.
6. Click on the “**Create Save**” button and the schedule is created.{CR-819}

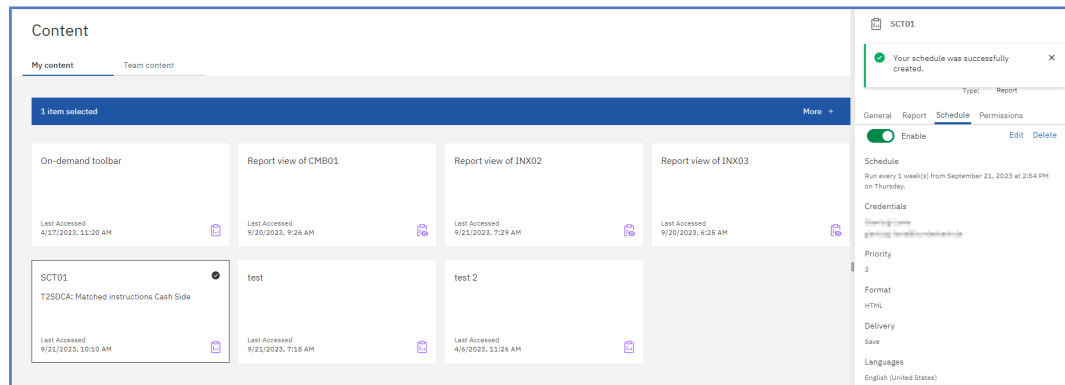

Illustration 299: **Welcome page - My content - Properties - Schedule** ⁶⁷{CR-819}

5.4.3.3 Check the schedule of your report

Instructions

1. To check the schedule of your report you have to navigate to the “*Personal menu*”.

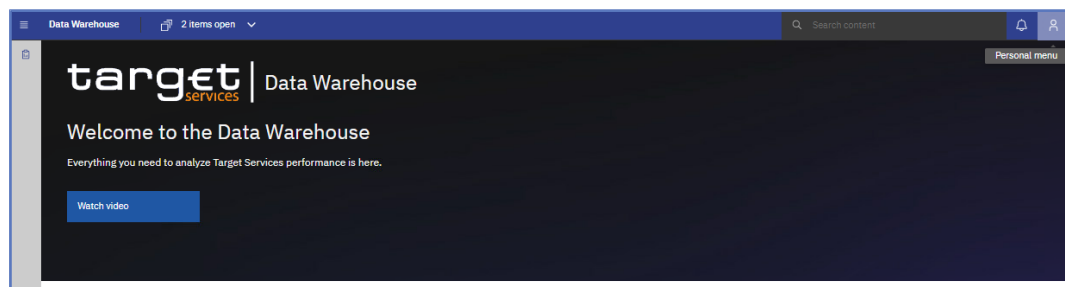

Illustration 300: **Welcome page - Personal menu**{CR-819}

2. Click on “*My schedules and subscriptions*”.

67 This content is not applicable as of R6.2, and will become applicable upon the deployment of the Data Warehouse for T2S.

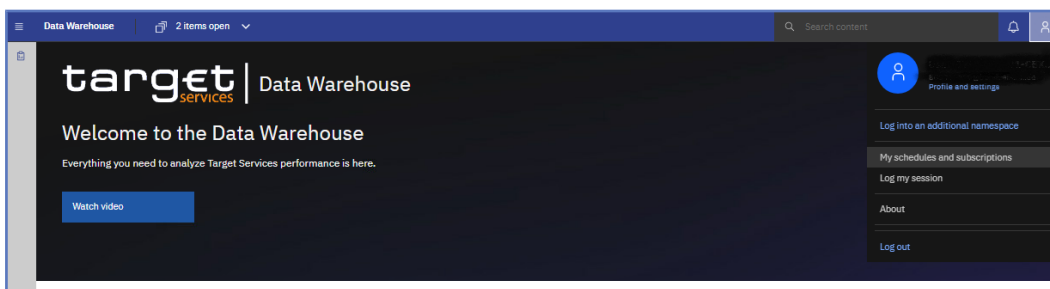

Illustration 301: Welcome page - Personal menu - My schedules and subscriptions {CR-819}

3. You can verify the reports that are scheduled.

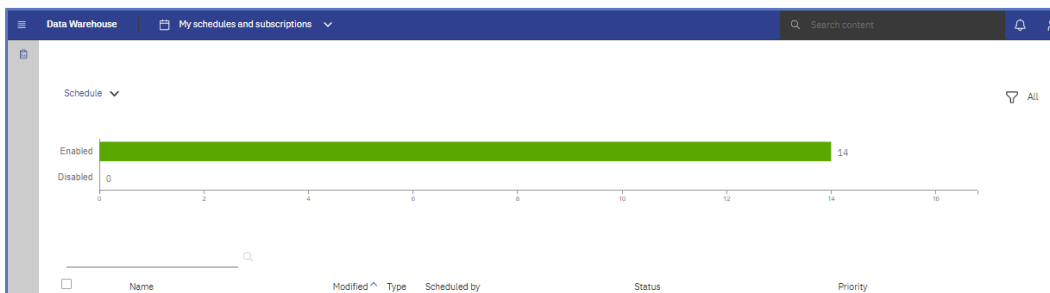

Illustration 302: Welcome page - Personal menu - My schedules and subscriptions - Schedule{CR-819}

Refer to chapter Personal menu [▶ 884] for further information. ⁶⁸

5.5 Predefined reports

5.5.1 T2S Cash account (SCT)

5.5.1.1 SCT01 – Finalised matched instructions

Context of Usage

This report shows the cash activity for all finalised matched settlement instructions (SI) at CB, PB or T2S dedicated cash account level, during a selected period of time. The volume of finalised matched instructions per transaction type / sub-category together with the aggregated matched values and settled values are shown.

This report can be used by CB **and PB** users.{CR-819}

Report Access

This report can be reached in the following way:

- ☐ **Content >>** Team Content >> **T2S >>** Predefined Reports >> **SCT**
- ☐ T2S Cash account >> SCT01 {CR-819}

68 This content is not applicable as of R6.2, and will become applicable upon the deployment of the Data Warehouse for T2S.

Screenshot

SCT01 – T2S DCA – Finalised matched instructions cash side – Prompt

Date from: *

Date to: *

Currency: *

Party BIC:

Keywords:

Select all

No Results

Starts with any of these keywords ▾

Case Insensitive

T2S DCA number:

Keywords:

Select all

No Results

Starts with any of these keywords ▾

Case Insensitive

Please search and select the party BIC

[Select all](#) [Deselect all](#)

Please search and select the T2S DCA number

[Select all](#) [Deselect all](#)

Illustration 303: **SCT01 prompt screen** {CR-819}

SCT01 – Finalised matched instructions – Prompt Screen	
Field Description	Date From
	You can select the date by clicking on the calendar. This field is mandatory.
Field Description	Date To
	You can select the end date of the period, for which the report should contain the data by clicking on the calendar.

SCT01 – Finalised matched instructions – Prompt Screen	
	<p>For valid report results, the current day cannot be selected.</p> <p>This field is mandatory.</p>
Currency	<p>You can use this drop-down field to select the currency.</p> <p>This field is mandatory.</p>
Party BIC	<p>You can use this drop-down field to select one or several party BIC. This field will show all related BICs, which belong to the default data scope of the user’s party.</p> <p>This field is optional.</p>
T2S DCA number	<p>You can use this drop-down field to select one or several T2S DCA numbers. This field will show all related T2S DCAs, which belong to default data scope of the user’s party and which belong to the parties selected in field “Party BIC”. If no Party BICs are selected, this field shows all T2S DCA numbers belonging to the default data scope of the user’s party.</p> <p>This field is optional.</p>

Screenshot

		Debit			Credit			Total		
Transaction type code	Transaction sub-category	Volume of settlement instruction	Matched value	Settled value	Volume of settlement instruction	Matched value	Settled value	Volume of settlement instruction	Matched value	Settled value
DVP	CATR	0	0	0	0	0	0	0	0	0
	STND	4.449	766.364.398.63	153.673.959.11	4.449	766.364.154.63	153.673.959.11	8.898	1.532.728.553.26	307.347.918.22
DWP	CATR	0	0	0	0	0	0	0	0	0
	STND	1.976	122.302.104.12	120.947.449.16	1.976	122.302.104.12	120.947.449.16	3.952	244.604.348.24	241.894.898.32
PFOD	CATR	815	6.250.099.15	6.217.593.12	815	6.250.099.15	6.217.593.12	1.630	12.500.198.30	12.435.186.24
	STND	0	0	0	0	0	0	0	0	0
Total		7.240	894.916.661.90	280.839.001.39	7.240	894.916.437.90	280.839.001.39	14.480	1.769.833.099.80	561.678.002.76

Illustration 304: SCT01 output screen{CR-819}

Field Description

SCT01 – Finalised matched instructions – Output Screen	
Transaction type code	<p>Shows the transaction type code of the settlement transaction.</p> <p>Possible values are:</p> <ul style="list-style-type: none"> <input type="checkbox"/> DVP (delivery versus payment) <input type="checkbox"/> DWP (delivery with payment) <input type="checkbox"/> PFOD (payment free of delivery)
Transaction sub-category	<p>Shows the transaction sub-category of the settlement transaction.</p> <p>Possible values are:</p> <ul style="list-style-type: none"> <input type="checkbox"/> CATR (cash transfer)

SCT01 – Finalised matched instructions – Output Screen	
	<input type="checkbox"/> STND (standard)
Debit	
Volume of settlement instructions	A count of all finalised matched SIs on the debit side during the selected date range, per transaction type code and sub-category.
Matched value	Sum of the matched settlement amounts of all finalised matched SIs on the debit side during the selected date range per transaction type code and sub-category.
Settled value	Sum of the settled settlement amounts of all finalised matched SIs on the debit side during the selected date range per transaction type code and sub-category.
Credit	
Volume of settlement instructions	A count of all finalised matched SIs on the credit side during the selected date range, per transaction type code and sub-category.
Matched value	Sum of the matched settlement amounts of all finalised matched SIs on the credit side during the selected date range per transaction type code and sub-category.
Settled value	Sum of the settled settlement amounts of all finalised matched SIs on the credit side during the selected date range per transaction type code and sub-category.
Total (per transaction type code/settlement transaction sub-category)	
Volume of settlement instructions	Sum of 'Volume of settlement instructions' over debit and credit.
Matched value	Sum of 'Matched value' over debit and credit.
Settled value	Sum of 'Settled value' over debit and credit.
Total	
Total	Sum for each column, summed over all transaction type / sub-category combinations. ⁶⁹

5.5.1.2 SCT02 – Detailed matched settlement instructions

Context of Usage

This report shows all finalised settlement instructions (SIs) at CB or PB or T2S dedicated cash account level, during a chosen period of time.

69 This content is not applicable as of R6.2, and will become applicable upon the deployment of the Data Warehouse for T2S.

The volume and values of settlement instructions are displayed per transaction type / sub-category / direction (debit or credit) and the settlement status.

This report can be used by CB **and PB** users. **{CR-819}**

Report Access

This report can be reached in the following way:

- Content >>** Team Content >> **T2S >>** Predefined Reports >> **SCT**
- T2S Cash account >> SCT02 **{CR-819}**

Screenshot

SCT02 - T2S DCA - Detailed matched settlement instruction – Prompt

Date from: * Feb 15, 2021

Date to: * Sep 15, 2023

Currency: * Euro

Party BIC:

Keywords:

Select all

No Results

Case Insensitive

Please search and select the party BIC

T2S DCA number

Keywords:

Select all

No Results

Case Insensitive

Please search and select the T2S DCA number

Illustration 305: **SCT02 Prompt {CR-819}**

Field Description

SCT02 – Detailed matched settlement instructions – Prompt screen	
Date From	You can select the date by clicking on the calendar. This field is mandatory.
Date To	You can select the end date of the period, for which the report should contain the data by clicking on the calendar. For valid report results, the current day cannot be selected. This field is mandatory.
Currency	You can use this drop-down field to select the currency. This field is mandatory.
Party BIC	You can use this drop-down field to select one or several party BIC. This field will show all related BICs, which belong to the default data scope of the user's party. This field is optional.
T2S DCA number	You can use this drop-down field to select one or several T2S DCA numbers. This field will show all related T2S DCAs, which belong to default data scope of the user's party and which belong to the parties selected in field "Party BIC". If no Party BICs are selected, this field shows all T2S DCA numbers belonging to the default data scope of the user's party. This field is optional.

Screenshot

		Debit				Credit				Total			
Transaction type code	Transaction sub-category	Volume totally settled	Volume partially settled / partially cancelled	Volume totally cancelled	Total	Volume totally settled	Volume partially settled / partially cancelled	Volume totally cancelled	Total	Volume totally settled	Volume partially settled / partially cancelled	Volume totally cancelled	Total
DVP	CATR	0	0	0	0	0	0	0	0	0	0	0	0
	STND	4,489	216	2,872	7,576	4,489	216	2,847	7,514	8,968	426	5,719	15,053
DVP	CATR	0	0	0	0	0	0	0	0	0	0	0	0
	STND	1,976	74	510	2,560	1,976	74	512	2,562	3,952	140	1,022	5,122
PFDD	CATR	815	0	231	1,046	815	0	231	1,046	1,630	0	462	2,092
	STND	0	0	0	0	0	0	0	0	0	0	0	0
Total		7,240	292	3,613	11,145	7,240	292	3,590	11,122	14,480	584	7,203	22,267

Illustration 306: SCT02 output screen, tab 1{CR-819}

		Debit				Credit				Total			
Transaction type code	Transaction sub-category	Matched value	Value totally settled	Value partially settled	Value partially cancelled	Value totally cancelled	Matched value	Value totally settled	Value partially settled	Value partially cancelled	Value totally cancelled	Matched value	Settled value (totally & partially)
DVP	CATR	0	0	0	0	0	0	0	0	0	0	0	0
	STND	746,364,396.52	150,103,125.84	3,579,833.27	1,797,766.73	419,826,612.73	746,364,154.63	159,183,125.84	3,579,833.27	1,797,766.73	419,826,346.75	1,532,128,563.26	317,347,619.22
DVP	CATR	0	0	0	0	0	0	0	0	0	0	0	0
	STND	122,382,164.12	120,443,898.12	503,453.04	499,286.96	855,566.08	122,382,164.12	129,443,896.12	503,453.04	499,286.96	855,528.00	244,864,348.24	241,894,896.32
PFDD	CATR	4,239,899.15	6,217,693.12	0.00	0.00	32,536.03	4,239,899.15	6,217,693.12	0.00	0.00	32,536.03	12,500,118.30	12,455,182.24
	STND	0	0	0	0	0	0	0	0	0	0	0	0
Total		816,916,691.00	276,764,718.08	4,074,286.31	2,297,073.69	611,814,542.78	816,916,437.30	276,764,718.08	4,074,286.31	2,297,073.69	611,814,424.76	1,789,833,899.80	661,678,002.78

Illustration 307: SCT02 output screen, tab 2{CR-819}

Field Description	SCT02 – Detailed matched settlement instructions – OUTPUT SCREEN – Tab 1 T2S DCA – Detailed finalised settlement instructions - volume	
Transaction type code	Shows the transaction type code of the settlement transaction.	Possible values are: <input type="checkbox"/> DVP (delivery versus payment) <input type="checkbox"/> DWP (delivery with payment) <input type="checkbox"/> PFOD (payment free of delivery)
Transaction sub-category	Shows the transaction sub-category of the settlement transaction.	Possible values are: <input type="checkbox"/> CATR (cash transfer) <input type="checkbox"/> STND (standard)
Debit		
Volume totally settled	A count of the number of totally settled SIs found on the debit side within the requested period, per transaction type and sub-category.	
Volume partially settled / partially cancelled	A count of the number of partially settled/partially cancelled SIs found on the debit side within the requested duration, per transaction type and sub-category.	
Volume totally cancelled	A count of the number of totally cancelled matched SIs found on the debit side within the requested duration, per transaction type and sub-category.	
Total	Sum of 'Volume totally settled', 'Volume partially settled / partially cancelled' and 'Volume totally cancelled' on the debit side, per transaction type and sub-category.	
Credit		
Volume totally settled	A count of the number of totally settled SIs found on the credit side within the requested duration, per transaction type and sub-category.	
Volume partially settled / partially cancelled	A count of the number of partially settled/partially cancelled SIs found on the credit side within the requested duration, per transaction type and sub-category.	
Volume totally cancelled	A count of the number of totally cancelled matched SIs found on the credit side within the requested duration, per transaction type and sub-category.	

SCT02 – Detailed matched settlement instructions – OUTPUT SCREEN – Tab 1	
T2S DCA – Detailed finalised settlement instructions - volume	
Total	Sum of 'Volume totally settled', 'Volume partially settled / partially cancelled' and 'Volume totally cancelled' on the credit side, per transaction type and sub-category.
Total (per transaction type code/settlement transaction sub-category)	
Volume totally settled	Sum of 'Volume totally settled' over debit and credit.
Volume partially settled / partially cancelled	Sum of 'Volume partially settled / partially cancelled' over debit and credit.
Volume totally cancelled	Sum of 'Volume totally cancelled' over debit and credit.
Total	Sum of 'Total' over debit and credit
Total	
Total	Sum for each column, summed over all transaction type / sub-category combinations.

SCT02 – Detailed matched settlement instructions – OUTPUT SCREEN – Tab 2	
T2S DCA – Detailed finalised settlement instructions - value	
Transaction type code	Shows the transaction type code of the settlement transaction. Possible values are: <ul style="list-style-type: none"> <input type="checkbox"/> DVP (delivery versus payment) <input type="checkbox"/> DWP (delivery with payment) <input type="checkbox"/> PFOD (payment free of delivery)
Transaction sub-category	Shows the transaction sub-category of the settlement transaction. Possible values are: <ul style="list-style-type: none"> <input type="checkbox"/> CATR (cash transfer) <input type="checkbox"/> STND (standard)
Debit	
Matched value	Sum over matched settlement amounts of all finalised SIs on the debit side within the requested duration, per transaction type and sub-category.

SCT02 – Detailed matched settlement instructions – OUTPUT SCREEN – Tab 2 T2S DCA – Detailed finalised settlement instructions - value	
Value totally settled	Sum over settled settlement amounts of all finalised SIs on the debit side and totally settled within the requested duration, per transaction type and sub-category.
Value partially settled	Sum over settled settlement amounts of all finalised SIs on the debit side and partially settled within the requested duration, per transaction type and sub-category.
Value partially cancelled	Sum over all unsettled matched settlement amounts of all finalised SIs on the debit side and partially cancelled within the requested duration, per transaction type and sub-category.
Value totally cancelled	Sum of the matched settlement amounts of all finalised SIs on the debit side which were totally cancelled within the period 1 duration, per transaction type and sub-category.
Credit	
Matched value	Sum over matched settlement amounts of all finalised SIs on the credit side within the requested duration, per transaction type and sub-category.
Value totally settled	Sum over settled settlement amounts of all finalised SIs on the credit side and totally settled within the requested duration, per transaction type and sub-category.
Value partially settled	Sum over settled settlement amounts of all finalised SIs on the credit side and partially settled within the requested duration, per transaction type and sub-category.
Value partially cancelled	Sum over all unsettled matched settlement amounts of all finalised SIs on the credit side and partially cancelled within the requested duration, per transaction type and sub-category.
Value totally cancelled	Sum of the matched settlement amounts of all finalised SIs on the credit side which were totally cancelled within the period 1 duration, per transaction type and sub-category.
Total (per transaction type code/settlement transaction sub-category)	
Matched value	Sum of 'Matched value' over debit and credit.
Settled value (totally + partially)	Sum of 'Value totally settled' plus 'Value partially settled' over debit and credit.

SCT02 – Detailed matched settlement instructions – OUTPUT SCREEN – Tab 2 T2S DCA – Detailed finalised settlement instructions - value	
Total	
Total	Sum for each column, summed over all transaction type / sub-category combinations. ⁷⁰

5.5.1.3 SCT03 – Follow up by time slot of settlement activity

Context of Usage

This report shows all finalised settlement instructions (SIs) per time slots of the settlement date in an array at CB, PB or T2S DCA level, during a chosen period of time.

The settlement instructions (SI) are displayed as aggregated volumes and values according to the transaction type code, the transaction sub-category, the T2S-DCA debit/credit code, the settlement status and T2S time slot

This report can be used by CB **and PB** users. **{CR-819}**

Report Access

This report can be reached in the following way:

- [Content >>](#) Team Content >> [T2S >>](#) Predefined Reports >> [SCT](#)
- T2S Cash account >> SCT03 **{CR-819}**

70 This content is not applicable as of R6.2, and will become applicable upon the deployment of the Data Warehouse for T2S.

Screenshot

SCT03 - T2S DCA - Follow-up by time slot of settlement activity

Date from: *

Date to: *

Currency: *

Party BIC:

Keywords:

Please search and select the party BIC

Select all

No Results

Starts with any of these keywords ▾

Case Insensitive

[Select all](#) [Deselect all](#)

T2S DCA number:

Keywords:

Please search and select the T2S DCA number

Select all

No Results

Starts with any of these keywords ▾

Case Insensitive

[Select all](#) [Deselect all](#)

Illustration 308: **SCT03 Prompt {CR-819}**

Field

Description

SCT03 – Follow-up by time slot of settlement activity – Prompt screen	
Date From	You can select the date by clicking on the calendar. This field is mandatory.
Date To	You can select the end date of the period, for which the report should contain the data by clicking on the calendar.

SCT03 – Follow-up by time slot of settlement activity – Prompt screen	
	<p>For valid report results, the current day cannot be selected.</p> <p>This field is mandatory.</p>
Currency	<p>You can use this drop-down field to select the currency.</p> <p>This field is mandatory.</p>
Party BIC	<p>You can use this drop-down field to select one or several party BIC. This field will show all related BICs, which belong to the default data scope of the user’s party.</p> <p>This field is optional.</p>
T2S DCA number	<p>You can use this drop-down field to select one or several T2S DCA numbers. This field will show all related T2S DCAs, which belong to default data scope of the user’s party and which belong to the parties selected in field “Party BIC”. If no Party BICs are selected, this field shows all T2S DCA numbers belonging to the default data scope of the user’s party.</p> <p>This field is optional.</p>

Screenshot

The screenshot displays the 'SCT03 - T2S DCA - Follow-up by time slot of settlement activity - volume' report. It includes a header with the T2S logo and the report title. Below the header, there are filter options for 'Date from' (2021-05-15), 'Date to' (2023-09-15), and 'Currency' (Euro). The main data is presented in a table with the following structure:

Transaction type code	Transaction sub-category	Settlement status	Volume of instructions -	Volume of instructions - Debit	Volume of instructions - Credit
			Volume	Volume	Volume
DVP	REPO	Totally cancelled	5,000	2,001	1,295
		Totally cancelled		34	34
		Totally settled		959	959
	STND	Partially settled		218	218
		Totally cancelled		2,872	2,847
		Totally settled		4,449	4,449
DWP	STND	Partially settled		74	74
		Totally cancelled		510	512
		Totally settled		1,976	1,976
FOP	COBS	Totally cancelled	14		
		Totally settled	236		
		Totally settled	1,540		
	REAL	Partially settled	312		
		Totally cancelled	3,757		
	REPO	Totally settled	4,930		
		Totally cancelled	60		
		Totally settled	648		
	STND	Partially settled	476		
		Totally cancelled	17,826	23	23

Illustration 309: SCT03 output screen, tab 1{CR-819}

Transaction type code	Transaction sub-category	Settlement status	Value of instructions -		Value of instructions - Credit	
			Value	Debit	Value	Value
DVP	REPO	Totally cancelled	0.00	0.00	0.00	0.00
		Totally settled				
		Totally settled		62,763,930.00		62,763,930.00
	STND	Partially settled		3,570,833.27		3,570,833.27
		Totally cancelled		0.00		0.00
		Totally settled		150,103,125.84		150,103,125.84
DWP	STND	Partially settled		503,453.04		503,453.04
		Totally cancelled		0.00		0.00
		Totally settled		120,443,996.12		120,443,996.12
FOP	COBS	Totally cancelled	0.00			
		Totally settled	0.00			
	PLED	Totally settled	0.00			
		Totally settled	0.00			
	REAL	Partially settled	0.00			
		Totally cancelled	0.00			
	REPO	Totally settled	0.00			
		Totally cancelled	0.00			
	STND	Totally settled	0.00			
		Partially settled	0.00			
	Totally cancelled	0.00	0.00			0.00

Illustration 310: SCT03 output screen, tab 2{CR-819}

Field Description

SCT03 – Follow-up by time slot of settlement activity – OUTPUT SCREEN – Tab 1	
T2S DCA – Follow-up by time slot of settlement activity - volume	
Transaction type code	Shows the transaction type code of the settlement transaction. Possible values are: <input type="checkbox"/> DVP (delivery versus payment) <input type="checkbox"/> DWP (delivery with payment) <input type="checkbox"/> PFOD (payment free of delivery)
Transaction sub-category	Shows the transaction sub-category of the settlement transaction. Possible values are: <input type="checkbox"/> CATR (cash transfer) <input type="checkbox"/> STND (standard)
Settlement status	Shows the status of the settlement instruction. Possible values are: <input type="checkbox"/> Totally settled <input type="checkbox"/> Partially settled / partially cancelled <input type="checkbox"/> Totally cancelled
Volume of instructions - debit	
Time slots (one line per time slot): <input type="checkbox"/> 1st NTS cycle <input type="checkbox"/> Last NTS cycle	Shows the aggregated volume of the SIs (debit side) for each designated time slot, within the transaction type code / transaction subcategory / settlement status combination.

SCT03 – Follow-up by time slot of settlement activity – OUTPUT SCREEN – Tab 1
T2S DCA – Follow-up by time slot of settlement activity - volume

<input type="checkbox"/> RT1 before intra-day DVP cut-off <input type="checkbox"/> RT2 before EOD intraday credit reimbursement <input type="checkbox"/> RT3 before EOD intraday FOP cut-off <input type="checkbox"/> RT4 after intraday FOP cut-off	
Volume of instructions - credit	
Time slots (one line per time slot): <input type="checkbox"/> 1st NTS cycle <input type="checkbox"/> Last NTS cycle <input type="checkbox"/> RT1 before intra-day DVP cut-off <input type="checkbox"/> RT2 before EOD intraday credit reimbursement <input type="checkbox"/> RT3 before EOD intraday FOP cut-off <input type="checkbox"/> RT4 after intraday FOP cut-off	Shows the aggregated volume of the SIs (credit side) for each designated time slot, within the transaction type code / transaction subcategory / settlement status combination.
Total	
Total	Sum for each column, summed over all transaction type / sub-category combinations.

SCT03 – Follow-up by time slot of settlement activity – OUTPUT SCREEN – Tab 2
T2S DCA – Follow-up by time slot of settlement activity - value

Transaction type code	Shows the transaction type code of the settlement transaction.
-----------------------	--

SCT03 – Follow-up by time slot of settlement activity – OUTPUT SCREEN – Tab 2 T2S DCA – Follow-up by time slot of settlement activity - value	
	Possible values are: <ul style="list-style-type: none"> <input type="checkbox"/> DVP (delivery versus payment) <input type="checkbox"/> DWP (delivery with payment) <input type="checkbox"/> PFOD (payment free of delivery)
Transaction sub-category	Shows the transaction sub-category of the settlement transaction. <p>Possible values are:</p> <ul style="list-style-type: none"> <input type="checkbox"/> CATR (cash transfer) <input type="checkbox"/> STND (standard)
Settlement status	Shows the status of the settlement instruction. <p>Possible values are:</p> <ul style="list-style-type: none"> <input type="checkbox"/> Totally settled <input type="checkbox"/> Partially settled <input type="checkbox"/> Totally cancelled <input type="checkbox"/> Partially cancelled
Value of instructions - debit	
Time slots (one line per time slot): <ul style="list-style-type: none"> <input type="checkbox"/> 1st NTS cycle <input type="checkbox"/> Last NTS cycle <input type="checkbox"/> RT1 before intraday DVP cut-off <input type="checkbox"/> RT2 before EOD intraday credit reimbursement <input type="checkbox"/> RT3 before EOD intraday FOP cut-off <input type="checkbox"/> RT4 after intraday FOP cut-off 	Shows the aggregated amount of the SIs (debit side) for each designated time slot, within the transaction type code / transaction subcategory / settlement status combination.
Value of instructions - credit	

SCT03 – Follow-up by time slot of settlement activity – OUTPUT SCREEN – Tab 2	
T2S DCA – Follow-up by time slot of settlement activity - value	
Time slots (one line per time slot): <ul style="list-style-type: none"> <input type="checkbox"/> 1st NTS cycle <input type="checkbox"/> Last NTS cycle <input type="checkbox"/> RT1 before intraday DVP cut-off <input type="checkbox"/> RT2 before EOD intraday credit reimbursement <input type="checkbox"/> RT3 before EOD intraday FOP cut-off <input type="checkbox"/> RT4 after intraday FOP cut-off 	Shows the aggregated amount of the SIs (credit side) for each designated time slot, within the transaction type code / transaction subcategory / settlement status combination.
Total	
Total	Sum for each column, summed over all transaction type / sub-category combinations. ⁷¹

5.5.1.4 SCT04 – Comparison of settlement activity between two time periods

Context of Usage

This report shows the settlement activity for two time periods at CB, PB or T2S dedicated cash account level, to allow its comparison between these two periods of time.

The settlement instructions (SI) are displayed as aggregated volumes and values according to the transaction type code, the transaction sub-category, the T2S-DCA debit/credit code and the settlement status.

This report can be used by CB **and PB** users. **{CR-819}**

Report Access

This report can be reached in the following way:

- [Content >>](#) Team Content >> [T2S >>](#) Predefined Reports >> [SCT](#)
- T2S Cash account >> SCT04{}

71 This content is not applicable as of R6.2, and will become applicable upon the deployment of the Data Warehouse for T2S.

Screenshot

SCT04 – T2S DCA – Comparison of settlement activity between two time periods

Period 1 - Date from: * Jun 15, 2022

Date to: * Sep 15, 2023

Period 2 - Date from: * Sep 15, 2022

Date to: * Sep 15, 2023

Currency: * Euro

Party BIC:

Keywords:

Select all

No Results

Starts with any of these keywords

Case Insensitive

Please search and select the securities party BIC

→

←

T2S DCA number:

Keywords:

Select all

No Results

Starts with any of these keywords

Case Insensitive

Please search and select the T2S DCA number

→

←

[Select all](#) [Deselect all](#)

Illustration 311: **SCT04 Prompt {CR-819}**

Field

Description

SCT04 – Comparison of settlement activity between two time periods – Prompt Screen	
Period 1 Date From	You can select the date by clicking on the calendar. This field is mandatory.

SCT04 – Comparison of settlement activity between two time periods – Prompt Screen	
Period 1 Date To	<p>You can select the end date of the period, for which the report should contain the data by clicking on the calendar.</p> <p>For valid report results, the current day cannot be selected.</p> <p>This field is mandatory.</p>
Period 2 Date From	<p>You can select the date by clicking on the calendar.</p> <p>This field is mandatory.</p>
Period 2 Date To	<p>You can select the end date of the period, for which the report should contain the data by clicking on the calendar.</p> <p>For valid report results, the current day cannot be selected.</p> <p>This field is mandatory.</p>
Currency	<p>You can use this drop-down field to select the currency.</p> <p>This field is mandatory.</p>
Party BIC	<p>You can use this drop-down field to select one or several party BIC. This field will show all related BICs, which belong to the default data scope of the user's party.</p> <p>This field is optional.</p>
T2S DCA number	<p>You can use this drop-down field to select one or several T2S DCA numbers. This field will show all related T2S DCAs, which belong to default data scope of the user's party and which belong to the parties selected in field "Party BIC". If no Party BICs are selected, this field shows all T2S DCA numbers belonging to the default data scope of the user's party.</p> <p>This field is optional.</p>

Screenshot

Illustration 312: SCT04 output screen(CR-819)

Field Description

SCT04 – Comparison of settlement activity between two time periods – Output Screen	
Period 1	
Transaction type code	Shows the transaction type code of the settlement transaction. Possible values are: <input type="checkbox"/> DVP (delivery versus payment) <input type="checkbox"/> DWP (delivery with payment) <input type="checkbox"/> PFOD (payment free of delivery)
Transaction sub-category	Shows the transaction sub-category of the settlement transaction. Possible values are: <input type="checkbox"/> CATR (cash transfer) <input type="checkbox"/> STND (standard)
Debit	
Volume totally settled	A count of the number of totally settled SIs found on the debit side in the period 1 duration, per transaction type and sub-category.
Volume partially settled/partially cancelled	A count of the number of partially settled/partially cancelled SIs found on the debit side in the period 1 duration, per transaction type and sub-category.
Volume totally cancelled	A count of the number of totally cancelled matched SIs found on the debit side in the period 1 duration, per transaction type and sub-category.
Value totally settled	Sum of the settled settlement amounts of all finalised SIs that were debited and totally settled within the period 1 duration, per transaction type and sub-category.

SCT04 – Comparison of settlement activity between two time periods – Output Screen	
Value partially settled	Sum of all partial settlement amounts of all finalised SIs that were debited and reached final status within the period 1 duration, per transaction type and sub-category.
Value partially cancelled	Sum of all unsettled settlement amounts of all finalised SIs that were debited and reached final status within the period 1 duration, per transaction type and sub-category.
Value totally cancelled	Sum of the settlement amounts of all finalised SIs on the debit side which were totally cancelled within the period 1 duration, per transaction type and sub-category.
Credit	
Volume totally settled	A count of the number of totally settled SIs found on the credit side in the period 1 duration, per transaction type and sub-category.
Volume partially settled/partially cancelled	A count of the number of partially settled/partially cancelled SIs found on the credit side in the period 1 duration, per transaction type and sub-category.
Volume totally cancelled	A count of the number of totally cancelled matched SIs found on the credit side in the period 1 duration, per transaction type and sub-category.
Value totally settled	Sum of the settled settlement amounts of all finalised SIs that were credited and totally settled within the period 1 duration, per transaction type and sub-category.
Value partially settled	Sum of all partial settlement amounts of all finalised SIs that were credited and reached final status within the period 1 duration, per transaction type and sub-category.
Value partially cancelled	Sum of all unsettled settlement amounts of all finalised SIs that were credited and reached final status within the period 1 duration, per transaction type and sub-category.
Value totally cancelled	Sum of the settlement amounts of all finalised SIs on the credit side which were totally cancelled within the period 1 duration, per transaction type and sub-category.
Total (Period 1 - final)	
Total	Sum for each column, summed over all transaction type / sub-category combinations.
Period 2	

SCT04 – Comparison of settlement activity between two time periods – Output Screen	
Transaction type code	Shows the transaction type code of the settlement transaction. Possible values are: <input type="checkbox"/> DVP (delivery versus payment) <input type="checkbox"/> DWP (delivery with payment) <input type="checkbox"/> PFOD (payment free of delivery)
Transaction sub-category	Shows the transaction sub-category of the settlement transaction. Possible values are: <input type="checkbox"/> CATR (cash transfer) <input type="checkbox"/> STND (standard)
Debit	
Volume totally settled	A count of the number of totally settled SIs found on the debit side in the period 2 duration, per transaction type and sub-category.
Volume partially settled/partially cancelled	A count of the number of partially settled/partially cancelled SIs found on the debit side in the period 2 duration, per transaction type and sub-category.
Volume totally cancelled	A count of the number of totally cancelled matched SIs found on the debit side in the period 2 duration, per transaction type and sub-category.
Value totally settled	Sum of the settled settlement amounts of all finalised SIs that were debited and totally settled within the period 2 duration, per transaction type and sub-category.
Value partially settled	Sum of all partial settlement amounts of all finalised SIs that were debited and reached final status within the period 2 duration, per transaction type and sub-category.
Value partially cancelled	Sum of all unsettled settlement amounts of all finalised SIs that were debited and reached final status within the period 2 duration, per transaction type and sub-category.
Value totally cancelled	Sum of the settlement amounts of all finalised SIs on the debit side which were totally cancelled within the period 2 duration, per transaction type and sub-category.
Credit	

SCT04 – Comparison of settlement activity between two time periods – Output Screen	
Volume totally settled	A count of the number of totally settled SIs found on the credit side in the period 2 duration, per transaction type and sub-category.
Volume partially settled/partially cancelled	A count of the number of partially settled/partially cancelled SIs found on the credit side in the period 2 duration, per transaction type and sub-category.
Volume totally cancelled	A count of the number of totally cancelled matched SIs found on the credit side in the period 2 duration, per transaction type and sub-category.
Value totally settled	Sum of the settled settlement amounts of all finalised SIs that were credited and totally settled within the period 2 duration, per transaction type and sub-category.
Value partially settled	Sum of all partial settlement amounts of all finalised SIs that were credited and reached final status within the period 2 duration, per transaction type and sub-category.
Value partially cancelled	Sum of all unsettled settlement amounts of all finalised SIs that were credited and reached final status within the period 2 duration, per transaction type and sub-category.
Value totally cancelled	Sum of the settlement amounts of all finalised SIs on the credit side which were totally cancelled within the period 2 duration, per transaction type and sub-category.
Total (Period 2 - final)	
Total	Sum for each column, summed over all transaction type / sub-category combinations. ⁷²

5.5.1.5 SCT05 – Follow-up by time slot of cash postings

Context of Usage

This report shows the cash postings at CB, PB or T2S dedicated cash account level, during a selected period of time. The cash postings activity of the specified T2S accounts are displayed as volume and value for each time slot of the business day with a total per balance type.

This report can be used by CB **and PB** users. **{CR-819}**

Report Access

This report can be reached in the following way:

- **[Content >>](#)** Team Content >> **[T2S >>](#)** Predefined Reports >> **[SCT](#)**
 - T2S Cash account >> SCT05**{CR-819}**

72 This content is not applicable as of R6.2, and will become applicable upon the deployment of the Data Warehouse for T2S.

Screenshot

SCT05 - T2S DCA - Follow-up by time slot of cash postings

Date from: *

Date to: *

Currency: *

Party BIC:

Keywords:

Select all

No Results

Please search and select the party BIC

Select all Deselect all

Starts with any of these keywords

Case Insensitive

T2S DCA number:

Keywords:

Select all

No Results

Please search and select the T2S DCA number

Select all Deselect all

Starts with any of these keywords

Case Insensitive

Illustration 313: **SCT05 Prompt screen {CR-819}**

Field

Description

SCT05 – Follow-up by time slot of cash postings – Prompt Screen	
Date From	You can select the date by clicking on the calendar. This field is mandatory.
Date To	You can select the end date of the period, for which the report should contain the data by clicking on the calendar. For valid report results, the current day cannot be selected.

SCT05 – Follow-up by time slot of cash postings – Prompt Screen	
	This field is mandatory.
Currency	You can use this drop-down field to select the currency. This field is mandatory.
Party BIC	You can use this drop-down field to select one or several party BIC. This field will show all related BICs, which belong to the default data scope of the user’s party. This field is optional.
T2S DCA number	You can use this drop-down field to select one or several T2S DCA numbers. This field will show all related T2S DCAs, which belong to default data scope of the user’s party and which belong to the parties selected in field “Party BIC”. If no Party BICs are selected, this field shows all T2S DCA numbers belonging to the default data scope of the user’s party. {CR-819} This field is optional.

Screenshot

The screenshot displays the 'SCT05 - T2S DCA - Follow-up by time slot of cash postings' report. It features a table with columns for 'Volume' and 'Value' across various time slots (T1 to T4) and transaction types (Debit, Credit, Total). The data is categorized into 'Blocking', 'CoSD Blocking', and 'Deliverable'.

Illustration 314: SCT05 output screen {CR-819}

Field Description

SCT05 – Follow-up by time slot of cash postings – Output Screen	
Balance type	Shows the balance type for which the cash postings are displayed from the possible values: <ul style="list-style-type: none"> <input type="checkbox"/> Earmarking <input type="checkbox"/> Blocking <input type="checkbox"/> CoSD blocking <input type="checkbox"/> Deliverable <input type="checkbox"/> Reservation

SCT05 – Follow-up by time slot of cash postings – Output Screen	
	For origin = “Liquidity Transfer”, only balance type = Deliverable” is possible.
Origin	Shows the posting origin for which the cash postings are displayed from the possible values: <ul style="list-style-type: none"> <input type="checkbox"/> Settlement instructions <input type="checkbox"/> Settlement restrictions <input type="checkbox"/> Liquidity transfers (only balance type “Deliverable”) <input type="checkbox"/> Total for all types
Debit	The aggregation within origin of the cash postings on the debited side
Credit	The aggregation within origin of the cash postings on the credited side
Total (per balance type / origin)	The sums of ‘Volume’ and ‘Value’ across ‘Debit’ and ‘Credit’ per column, within origin.
Time slots: <ul style="list-style-type: none"> <input type="checkbox"/> 1st NTS cycle <input type="checkbox"/> Last NTS cycle <input type="checkbox"/> RT1 before intraday DVP cut-off <input type="checkbox"/> RT2 before EOD intraday credit reimbursement <input type="checkbox"/> RT3 before EOD intraday FOP cut-off <input type="checkbox"/> RT4 after intraday FOP cut-off 	The aggregation within debit/credit/total of all cash postings found for each designated time-slot.
Volume	The aggregated number of cash postings are displayed for each balance type, origin and debit/credit/total within each of the above time slots.
Value	The aggregated amount of cash postings are displayed for each balance type, origin and debit/credit/total within each of the above time slots.

SCT05 – Follow-up by time slot of cash postings – Output Screen	
Total (per balance type):	The sums of 'Volume' and 'Value' across 'Debit' and 'Credit' per column, over all origins within balance type.
<input type="checkbox"/> Total earmarking	
<input type="checkbox"/> Total blocking	
<input type="checkbox"/> Total COSD blocking	
<input type="checkbox"/> Total deliverable	
<input type="checkbox"/> Total reservation	
Total (final)	The sums of 'Volume' and 'Value' across 'Debit' and 'Credit' per column, over all balance types. ⁷³

5.5.2 T2S Securities account (SST)

5.5.2.1 SST01 – Finalised matched instructions

Context of Usage

This report shows volumes, values and quantities for all finalised settlement instructions (SIs), at CSD or CSD participant or securities account level, during a selected period of time. The settlement instructions are filtered according the settlement types of the securities and the currency of the settlements that the user selects.

The report delivers the volume of matched settlement instructions finalised during the selected period whether settled, partially settled or cancelled, the total of original quantity whether settled, partially settled or cancelled, the settled quantity, the matched value and the settled value.

The results are displayed aggregated per transaction type code, transaction subcategory and securities movement type.

This report can be used by CSD, ~~external CSD (ECSD) and CSD participant (CSDP)~~ users. **{CR-819}**

Report Access

This report can be reached in the following way:

- [Content >>](#) Team Content >> [T2S >>](#) Predefined Reports >> [SST - T2S Securities account >> SST01](#) **{CR-819}**

73 This content is not applicable as of R6.2, and will become applicable upon the deployment of the Data Warehouse for T2S.

Screenshot

SST01 - Securities account - Finalised matched instructions - Prompt

Date from: *

Date to: *

Currency: *

Settlement type: *

Party BIC:

Keywords:

Select all

No Results

Case Insensitive

Securities account number:

Keywords:

Select all

No Results

Case Insensitive

Please search and select the securities party BIC

[Select all](#) [Deselect all](#)

Please search and select the securities account number

[Select all](#) [Deselect all](#)

Illustration 315: **SST01 prompt screen {CR-819}**

Field Description

SST01 – Finalised matched instructions – Prompt Screen	
Date From	You can select the date by clicking on the calendar. This field is mandatory.
Date To	You can select the end date of the period, for which the report should contain the data by clicking on the calendar. For valid report results, the current day cannot be selected. This field is mandatory.
Currency	Currency in which the SIs are settled. You can use this drop-down field to select the currency. This field is mandatory.
Party BIC	You can use this drop-down field to select one or several party BIC. This field will show all related BICs, which belong to the default data scope of the user's party. This field is optional.

SST01 – Finalised matched instructions – Prompt Screen	
Securities account number	<p>You can use this drop-down field to select one or several securities account numbers. This field will show all related securities accounts which belong to default data scope of the user’s party and which belong to the parties selected in field “Party BIC”. If no Party BICs are selected, this field shows all securities account numbers belonging to the default data scope of the user’s party.</p> <p>This field is optional.</p>
Securities ISIN{CR-819}	<p>The report output contains only settlement instructions with the selected securities.</p> <p>This field is optional.</p>
Securities movement type	<p>This selection specifies if the movement on a securities account results from a delivery or a receive instruction.</p> <p>Possible values:</p> <ul style="list-style-type: none"> <input type="checkbox"/> DELI <input type="checkbox"/> RECE <p>This field is optional.</p>

Screenshot

SST01 - Securities account - Finalised matched instructions											
CSD\AT\FF\801 - CSD\AT\Ranged - AB											
Filters		Date from : 2021-01-18 Date to: 2023-12-18									
		Currency : Euro									
		Settlement type : F&MT - Nominal									
Securities account - Detailed finalised settlement instructions - volume											
DELI						RECE					
Transaction type code	Settlement transaction sub-category	Volume of settlement instructions	Instructed quantity	Settled quantity	Matched value	Settled value	Volume of settlement instructions	Instructed quantity	Settled quantity	Matched value	Settled value
DVP	STND	24	128,000	87,500	133,900.00	91,382.36	24	128,000	87,500	133,900.00	91,382.36
FOP	STND	69	252,500	251,500	0.00	0.00	69	252,500	251,500	0.00	0.00
Total		93	380,500	339,000	133,900.00	91,382.36	93	380,500	339,000	133,900.00	91,382.36
Total											
Transaction type code	Settlement transaction sub-category	Volume of settlement instructions	Instructed quantity	Settled quantity	Matched value	Settled value					
DVP	STND	48	256,000	175,000	267,800.00	182,764.72					
FOP	STND	138	505,000	503,000	0.00	0.00					
Total		186	761,000	678,000	267,800.00	182,764.72					

Illustration 316: SST01 output screen{CR-819}

Field Description

SST01 – Finalised matched instructions – Output Screen	
DELI (only filled if movement type filter selected ‘DELI’ or all)	
Transaction type code	<p>Shows the settlement transaction type code set during the selected period duration of time from the possible values:</p> <ul style="list-style-type: none"> <input type="checkbox"/> DVP (delivery versus payment) <input type="checkbox"/> DWP (delivery with payment) <input type="checkbox"/> FOP (free of payment) <input type="checkbox"/> PFOD (payment free of delivery)

SST01 – Finalised matched instructions – Output Screen	
Transaction sub-category	Shows the subcategory of the settlement transaction from the possible values: <input type="checkbox"/> ALOP, BPDF, BPIN, BPSU, COBS, COBR, COCP, CORT, CORU, EPDE, EPIS, REAL, RERV, REPO, RPDE, RPIN, RPSU, STND
Volume of settlement instructions	Count of the number of finalised DELI settlement instructions within the given search criteria, per transaction type code and settlement transaction sub-category.
Original Instructed quantity	Sum of original instructed settlement quantities of the DELI settlement instructions, per transaction type code and sub-category{ CR-819 }
Settled quantity	Sum of settled quantities of the DELI settlement instructions, per transaction type code and sub-category
Matched value	Sum of matched settlement amounts of the DELI settlement instructions, per transaction type code and sub-category
Settled value	Sum of settled settlement amounts of the DELI settlement instructions, per transaction type code and sub-category
Total	Sum for each column in 'DELI' body, summed over all transaction type / sub-category combinations.
RECE (only filled if movement type filter selected 'RECE' or all)	
Transaction type code	Shows the settlement transaction type code set during the selected period duration of time from the possible values: <input type="checkbox"/> DVP (Delivery versus payment) <input type="checkbox"/> DWP (Delivery with payment) <input type="checkbox"/> FOP (free of payment) <input type="checkbox"/> PFOD (payment free of delivery)
Transaction sub-category	Shows the subcategory of the settlement transaction from the possible values: <input type="checkbox"/> ALOP, BPDF, BPIN, BPSU, COBS, COBR, COCP, CORT, CORU, EPDE, EPIS, REAL, RERV, REPO, RPDE, RPIN, RPSU, STND
Volume of settlement instructions	Count of the number of finalised RECE settlement instructions within the given search criteria, per transaction type code and settlement transaction sub-category.

SST01 – Finalised matched instructions – Output Screen	
Original Instructed quantity	Sum of original instructed settlement quantities of the RECE settlement instructions, per transaction type code and sub-category{ CR-819 }
Settled quantity	Sum of settled quantities of the RECE settlement instructions, per transaction type code and sub-category
Matched value	Sum of matched settlement amounts of the RECE settlement instructions, per transaction type code and sub-category
Settled value	Sum of settled settlement amounts of the RECE settlement instructions, per transaction type code and sub-category
Total	Sum for each column in 'RECE' body, summed over all transaction type / sub-category combinations.
Total (always filled and sums across all movement types selected in the filter)	
Transaction type code	Shows the settlement transaction type code set during the selected period duration of time from the possible values: <ul style="list-style-type: none"> <input type="checkbox"/> DVP (delivery versus payment) <input type="checkbox"/> DWP (delivery with payment) <input type="checkbox"/> FOP (free of payment) <input type="checkbox"/> PFOD (payment free of delivery)
Transaction sub-category	Shows the subcategory of the settlement transaction from the possible values: <ul style="list-style-type: none"> <input type="checkbox"/> ALOP, BPDF, BPIN, BPSU, COBS, COBR, COCP, CORT, CORU, EPDE, EPIS, REAL, RERV, REPO, RPDE, RPIN, RPSU, STND
Volume of settlement instructions	The sum of 'Volume of settlement instructions' over DELI and RECE, per transaction type code and settlement transaction sub-category.
Original Instructed quantity	The sum of ' Instructed-Original quantity' over DELI and RECE, per transaction type code and settlement transaction sub-category.{ CR-819 }
Settled quantity	The sum of 'Settled quantity' over DELI and RECE, per transaction type code and settlement transaction sub-category.

SST01 – Finalised matched instructions – Output Screen	
Matched value	The sum of 'Matched value' over DELI and RECE, per transaction type code and settlement transaction sub-category.
Settled value	The sum of 'Settled value' over DELI and RECE, per transaction type code and settlement transaction sub-category.
Total	Sum for each column in 'Total' body, summed over all transaction type / sub-category combinations. ⁷⁴

5.5.2.2 SST02 – Detailed finalised matched instructions

Context of Usage

This report shows detailed information on volume and quantities for all finalised settlement instructions (SIs), at CSD or CSD participant or securities account level, during a selected period of time. The settlement instructions are filtered according the settlement types of the securities that the user selects.

The volume, the **original instructed** quantities and the settled quantities of settlement instructions are displayed per settlement status.**{CR-819}**

The results are displayed aggregated per transaction type code, transaction sub-category and securities movement type and as totals.

This report can be used by CSD, **external CSD (ECSD) and CSD participant (CSDP)** users.**{}**

Report Access

This report can be reached in the following way:

- **Content >>** Team Content >> **T2S >>** Predefined Reports >> **SST**
 - T2S Securities account >> SST02**{CR-819}**

74 This content is not applicable as of R6.2, and will become applicable upon the deployment of the Data Warehouse for T2S.

Screenshot

SST02 – Securities account – Detailed finalised matched instructions - Prompt

Date from: *

Date to: *

Settlement type: *
 FAMT - Nominal
 UNIT - Units

Party BIC:

Keywords:

Select all

No Results

Starts with any of these keywords

Case Insensitive

Please search and select the party BIC

[Select all](#) [Deselect all](#)

Securities account number:

Keywords:

Select all

No Results

Starts with any of these keywords

Case Insensitive

Please search and select the securities account number

[Select all](#) [Deselect all](#)

Illustration 317: **SST02 Prompt {CR-819}**

Field Description

SST02 – Detailed finalised matched instructions – Prompt screen	
Date From	You can select the date by clicking on the calendar. This field is mandatory.
Date To	You can select the end date of the period, for which the report should contain the data by clicking on the calendar. For valid report results, the current day cannot be selected. This field is mandatory.
Currency	Currency in which the SIs are settled. You can use this drop-down field to select the currency. This field is mandatory.
Party BIC	You can use this drop-down field to select one or several party BIC. This field will show all related BICs, which belong to the default data scope of the user's party. This field is optional.
Securities account number	You can use this drop-down field to select one or several securities account numbers. This field will show all related securities accounts which belong to

SST02 – Detailed finalised matched instructions – Prompt screen	
	<p>default data scope of the user’s party and which belong to the parties selected in field “Party BIC”. If no Party BICs are selected, this field shows all securities account numbers belonging to the default data scope of the user’s party.</p> <p>This field is optional.</p>
Securities ISIN{CR-819}	<p>The report output contains only settlement instructions with the selected securities.</p> <p>This field is optional.</p>
Securities movement type	<p>This selection specifies if the movement on a securities account results from a delivery or a receive instruction.</p> <p>Possible values:</p> <ul style="list-style-type: none"> <input type="checkbox"/> DELI <input type="checkbox"/> RECE <p>This field is optional.</p>

Screenshot

Transaction type code	Transaction sub-category	DELI			RECE			Total		
		Volume totally settled	Volume partially settled / partially cancelled	Volume totally cancelled	Volume totally settled	Volume partially settled / partially cancelled	Volume totally cancelled	Volume totally settled	Volume partially settled / partially cancelled	Volume totally cancelled
DVP	REPO	137	0	34	0	0	34	0	0	68
	STND	842	72	962	842	72	962	1,684	144	1,824
DVP	STND	46	5	95	46	5	95	92	10	196
FOP	COBS	4	0	0	4	0	0	0	0	0
	PLED	186	0	0	186	0	0	212	0	0
	REAL	413	72	112	414	72	222	627	144	334
	REPO	50	0	9	50	0	9	100	0	18
	STND	8,267	79	1,251	8,267	79	1,251	12,524	146	2,912
PFOD	CATR	391	0	134	391	0	134	782	0	268
	PLED	64	0	0	64	0	0	128	0	0
	SPLD	22	0	0	22	0	0	44	0	0
Total		9,242	219	3,869	9,242	219	2,719	16,885	426	5,328

Illustration 318: SST02 output screen, tab 1{CR-819}

Transaction type code	Transaction sub-category	DELI			RECE			Total			
		Instructed quantity	Quantity totally settled	Quantity partially cancelled	Instructed quantity	Quantity totally settled	Quantity partially cancelled	Instructed quantity	Quantity settled (totally + partially)	Quantity cancelled (totally + partially)	
DVP	STND	129,000	31,500	56,000	10,000	30,500	129,000	31,500	10,000	30,500	175,000
FOP	STND	252,000	251,500	0	0	1,000	252,000	251,500	0	1,000	505,000
Total		380,500	283,000	56,000	10,000	31,500	380,500	283,000	56,000	10,000	678,000

Illustration 319: SST02 output screen, tab 2{CR-819}

Field Description

SCST02 – Detailed matched settlement instructions – OUTPUT SCREEN – Tab 1	
Securities account – Detailed finalised instructions - volume{CR-819}	
Transaction type code	<p>Shows the settlement transaction type code set during the selected period duration of time from the possible values:</p> <ul style="list-style-type: none"> <input type="checkbox"/> DVP (delivery versus payment) <input type="checkbox"/> DWP (delivery with payment)

SCST02 – Detailed matched settlement instructions – OUTPUT SCREEN – Tab 1	
Securities account – Detailed finalised instructions - volume{CR-819}	
	<input type="checkbox"/> FOP (free of payment) <input type="checkbox"/> PFOD (payment free of delivery)
Settlement transaction sub-category	Shows the subcategory of the settlement transaction from the possible values: <input type="checkbox"/> ALOP, BPDF, BPIN, BPSU, COBS, COBR, COCP, CORT, CORU, EPDE, EPIS, REAL, RERV, REPO, RPDE, RPIN, RPSU, STND
DELI	
Volume totally settled	A count of the number of totally settled SIs with security movement type DELI, per transaction type and sub-category.
Volume partially settled / partially cancelled	A count of the number of partially settled/partially cancelled SIs with security movement type DELI, per transaction type and sub-category.
Volume totally cancelled	A count of the number of totally cancelled matched SIs with security movement type DELI, per transaction type and sub-category.
Total	Sum of 'Volume totally settled', 'Volume partially settled / partially cancelled' and 'Volume totally cancelled' in the 'DELI' sub-table, per transaction type and sub-category.
RECE	
Volume totally settled	A count of the number of totally settled SIs found with security movement type RECE, per transaction type and sub-category.
Volume partially settled / partially cancelled	A count of the number of partially settled/partially cancelled SIs with security movement type RECE, per transaction type and sub-category.
Volume totally cancelled	A count of the number of totally cancelled matched SIs found with security movement type RECE, per transaction type and sub-category.

SCST02 – Detailed matched settlement instructions – OUTPUT SCREEN – Tab 1	
Securities account – Detailed finalised instructions - volume{CR-819}	
Total	Sum of 'Volume totally settled', 'Volume partially settled / partially cancelled' and 'Volume totally cancelled' in the 'RECE' sub-table, per transaction type and sub-category.
Total (across all movement types selected in the filter)	
Volume totally settled	Sum of 'Volume totally settled' 'over 'DELI' and 'RECE' sub-tables, per transaction type and sub-category.
Volume partially settled / partially cancelled	Sum of 'Volume partially settled / partially cancelled' 'over 'DELI' and 'RECE' sub-tables, per transaction type and sub-category.
Volume totally cancelled	Sum of 'Volume totally cancelled' 'over 'DELI' and 'RECE' sub-tables, per transaction type and sub-category.
Total	Sum of 'Total' 'over 'DELI' and 'RECE' sub-tables, per transaction type and sub-category.
Total	
Total	Sum for each column, summed over all transaction type / sub-category combinations.

SCST02 – Detailed matched settlement instructions – OUTPUT SCREEN – Tab 2	
Securities account – Detailed finalised instructions - quantity{CR-819}	
Transaction type code	Shows the settlement transaction type code set during the selected period duration of time from the possible values: <ul style="list-style-type: none"> <input type="checkbox"/> DVP (delivery versus payment) <input type="checkbox"/> DWP (delivery with payment) <input type="checkbox"/> FOP (free of payment) <input type="checkbox"/> PFOD (payment free of delivery)
Settlement transaction sub-category	Shows the subcategory of the settlement transaction from the possible values: <ul style="list-style-type: none"> <input type="checkbox"/> ALOP, BPDF, BPIN, BPSU, COBS, COBR, COCP, CORT, CORU, EPDE, EPIS, REAL, RERV, REPO, RPDE, RPIN, RPSU, STND
DELI	

SCST02 – Detailed matched settlement instructions – OUTPUT SCREEN – Tab 2	
Securities account – Detailed finalised instructions - quantity{CR-819}	
Original Instructed quantity	Sum of original instructed settlement quantities of all finalised SIs with securities movement type DELI, per transaction type and sub-category.{CR-819}
Quantity totally settled	Sum of settled settlement quantities of all totally settled SIs with securities movement type DELI, per transaction type and sub-category.
Quantity partially settled	Sum of settled settlement quantities of all partially settled SIs with securities movement type DELI, per transaction type and sub-category.
Quantity partially cancelled	Sum of unsettled settlement quantities of all partially cancelled SIs with securities movement type DELI, per transaction type and sub-category.
Quantity totally cancelled	Sum of unsettled settlement quantities of all totally cancelled SIs with securities movement type DELI, per transaction type and sub-category.
RECE	
Original Instructed quantity	Sum of original instructed settlement quantities of all finalised SIs with securities movement type RECE, per transaction type and sub-category.{CR-819}
Quantity totally settled	Sum of settled settlement quantities of all totally settled SIs with securities movement type RECE, per transaction type and sub-category.
Quantity partially settled	Sum of settled settlement quantities of all partially settled SIs with securities movement type RECE, per transaction type and sub-category.
Quantity partially cancelled	Sum of unsettled settlement quantities of all partially cancelled SIs with securities movement type RECE, per transaction type and sub-category.
Quantity totally cancelled	Sum of unsettled settlement quantities of all totally cancelled SIs with securities movement type RECE, per transaction type and sub-category.
Total (across all movement types selected in the filter)	
Original Instructed quantity	The sum of ' Original Instructed quantity' over 'DELI' and 'RECE', per transaction type and sub-category.{CR-819}

SCST02 – Detailed matched settlement instructions – OUTPUT SCREEN – Tab 2	
Securities account – Detailed finalised instructions - quantity{CR-819}	
Quantity settled (totally + partially)	The sum of ‘Quantity totally settled’ and ‘Quantity partially settled’ over ‘DELI’ and ‘RECE’, per transaction type and sub-category.
Total	
Total	Sum for each column, summed over all transaction type / sub-category combinations. ⁷⁵

5.5.2.3 SST03 – Follow-up by time slot of securities postings

Context of Usage

This report shows the securities postings at CSD, CSDP or securities account level, during a selected period of time. The securities postings activity of the specified securities accounts are displayed as volume and quantity of securities for each time slot of the business day with a total per balance type..

This report can be used by CSD, ~~CSDP and external CSD~~ users.{CR-819}

Report Access

This report can be reached in the following way:

- [Content >>](#) Team Content >> [T2S >>](#) Predefined Reports >> [SST](#)
- T2S Securities account >> SST03{CR-819}

75 This content is not applicable as of R6.2, and will become applicable upon the deployment of the Data Warehouse for T2S.

Screenshot

Illustration 320: SST03 Prompt screen {CR-819}

Field Description

SST03 – Follow-up by time slot of securities postings – Prompt Screen	
Date From	You can select the date by clicking on the calendar. This field is mandatory.
Date To	You can select the end date of the period, for which the report should contain the data by clicking on the calendar.

SST03 – Follow-up by time slot of securities postings – Prompt Screen	
	<p>For valid report results, the current day cannot be selected.</p> <p>This field is mandatory.</p>
Currency	<p>Currency in which the SIs are settled.</p> <p>You can use this drop-down field to select the currency.</p> <p>This field is mandatory.</p>
Party BIC	<p>You can use this drop-down field to select one or several party BIC. This field will show all related BICs, which belong to the default data scope of the user's party.</p> <p>This field is optional.</p>
Securities account number	<p>You can use this drop-down field to select one or several securities account numbers. This field will show all related securities accounts which belong to default data scope of the user's party and which belong to the parties selected in field "Party BIC". If no Party BICs are selected, this field shows all securities account numbers belonging to the default data scope of the user's party.</p> <p>This field is optional.</p>
Securities ISIN{CR-819}	<p>The report output contains only settlement instructions with the selected securities.</p> <p>This field is optional.</p>

Screenshot

TARGET SERVICES		SST03 - Securities account - Follow-up by time schedule of securities postings	
<p>Filters: Date from: 2023-11-27 Date to: 2023-11-27 Settlement type: FAMT</p>			
<p>Securities account - Follow-up by time slot of securities postings</p>			
Earmarking	Settlement instructions	Debit	255 -255
		Credit	259 -259
		Total	574 -574
	Settlement restrictions	Debit	73 -73
		Credit	121 -121
		Total	194 -194
Total	Credit	410 -410	
	Debit	358 -358	
	Total	788 -788	
Blocking	Settlement instructions	Debit	6 -6
		Total	6 -6
	Settlement restrictions	Debit	109 -109
		Credit	343 -343
		Total	452 -452
	Total	Credit	343 -343
	Debit	115 -115	
	Total	458 -458	
CoSD Blocking	Settlement restrictions	Debit	58 -58
		Credit	59 -59
		Total	115 -115

Illustration 321: SST03 output screen {CR-819}

Field Description	SGST053 – Follow-up by time slot of cash postings – Output Screen{CR-819}	
Balance type	Shows the balance type for which the securities postings are displayed from the possible values: <ul style="list-style-type: none"> <input type="checkbox"/> Earmarking <input type="checkbox"/> Blocking <input type="checkbox"/> CoSD blocking <input type="checkbox"/> Deliverable <input type="checkbox"/> Earmarking for auto-collateralisation <input type="checkbox"/> Reservation 	
Origin	Shows the posting origin for which the securities postings are displayed from the possible values: <ul style="list-style-type: none"> <input type="checkbox"/> Settlement instructions <input type="checkbox"/> Settlement restrictions <input type="checkbox"/> Total for all types 	
Debit	The aggregation within origin of the securities postings on the debited side	
Credit	The aggregation within origin of the securities postings on the credited side	
Total (per balance type / origin)	The sums of 'Volume' and 'Quantity' across 'Debit' and 'Credit' per column, within origin.	
Time slots: <ul style="list-style-type: none"> <input type="checkbox"/> 1st NTS cycle <input type="checkbox"/> Last NTS cycle <input type="checkbox"/> RT1 before intraday DVP cut-off <input type="checkbox"/> RT2 before EOD intraday credit reimbursement <input type="checkbox"/> RT3 before EOD intraday FOP cut-off <input type="checkbox"/> RT4 after intraday FOP cut-off 	The aggregation within debit/credit/total of all securities postings found for each designated time-slot.	

SGST053 – Follow-up by time slot of cash postings – Output Screen{CR-819}	
Volume	The aggregated number of securities postings are displayed for each balance type, origin and debit/credit/total within each of the above time slots.
Quantity	The aggregated quantity of securities postings are displayed for each balance type, origin and debit/credit/total within each of the above time slots.
Total (per balance type): <input type="checkbox"/> Total earmarking <input type="checkbox"/> Total blocking <input type="checkbox"/> Total COSD blocking <input type="checkbox"/> Total deliverable <input type="checkbox"/> Total earmarking for autocollateralisation <input type="checkbox"/> Total reservation	The sums of 'Volume' and 'Quantity' across 'Debit' and 'Credit' per column, over all origins within balance type.
Total (final)	The sums of 'Volume' and 'Quantity' across 'Debit' and 'Credit' per column, over all balance types. ⁷⁶

5.5.3 T2S Instructions (INX)

5.5.3.1 INX01 – Individual settlement detailed report

Context of Usage

This report shows all finalised business settlement instructions (SI) corresponding to the selected T2S references.

The attributes shown in the output provide business details related to each of the selected settlement instructions and are displayed in a manner which allows easy comparison between these instructions.

This report can be used by CSD, ~~CSDP and ECSD~~ users. **{CR-819}**

Report Access

This report can be reached in the following way:

76 This content is not applicable as of R6.2, and will become applicable upon the deployment of the Data Warehouse for T2S.

□ [Content >>](#) Team Content >> [T2S >>](#) Predefined Reports >> [INX](#)
 - T2S Instructions >> INX01{CR-819}

Screenshot



Illustration 322: INX01 prompt screen {CR-819}

Field

Description

INX01 – Individual settlement detailed report – Prompt Screen	
T2S actor instruction reference	You can use this drop-down field to select one or several T2S actor instruction references. This field will show all related references, which belong to the default data scope of the user’s party. This field is mandatory.

Screenshot

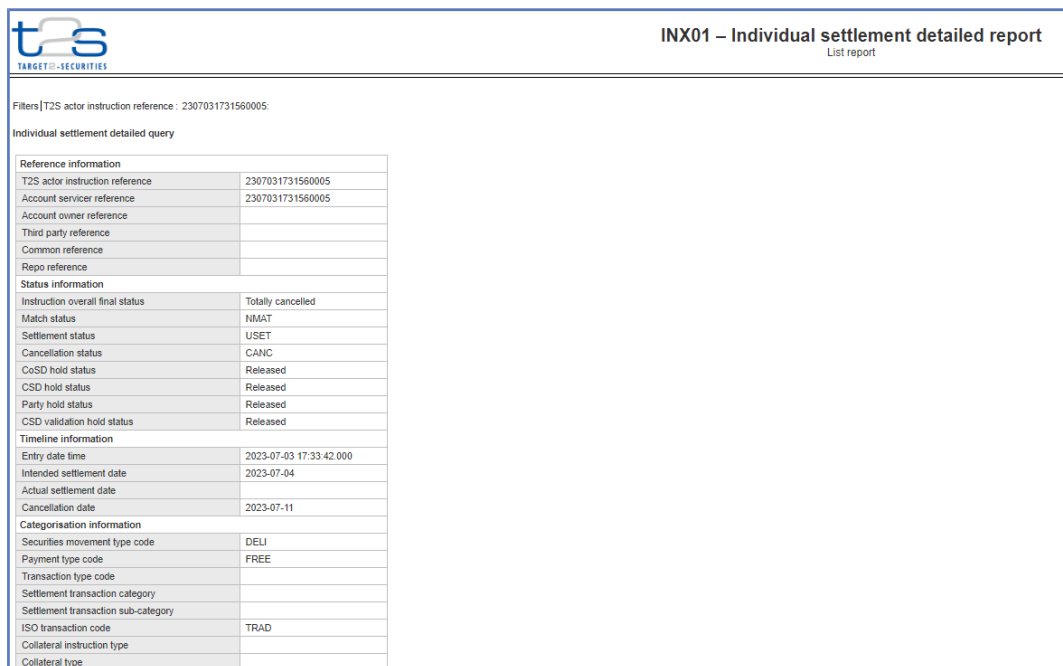

Securities information	
ISIN	ATC8AT000018
Account owner BIC	CSDYATFF801
Securities account number	ISSAC8AT001
T2S delivering party securities account number	ISSAC8AT001
T2S receiving party securities account number	CSDPC8AT02001
Securities sub balance type	
Settlement type	UNIT
Instructed settlement quantity	123
Settled settlement quantity	0
Totally settled settlement quantity	0
Partially settled settlement quantity	0
Partially cancelled settlement quantity	0
Totally cancelled settlement quantity	0
Securities party information	
Delivering depository BIC	CSDYATFF801
T2S delivering party BIC	CSDYATFF801
Delivering settlement party processing reference	
Client of delivering CSD participant BIC	
Client of delivering CSD participant Id	
Client of delivering CSD participant issuer	
Client of delivering CSD participant schema name	
Receiving depository BIC	CSDYATFF801
T2S receiving party BIC	CSDPATFF802
Receiving settlement party processing reference	
Client of receiving CSD participant BIC	
Client of receiving CSD participant Id	
Client of receiving CSD participant issuer	
Client of receiving CSD participant schema name	
Cash information	
Currency code	
Credit/debit code	
Debtor party BIC	
Creditor party BIC	
T2S dedicated cash account number	
Debtor T2S dedicated cash account number	
Creditor T2S dedicated cash account number	
Instructed settlement amount	0.00
Transaction original amount	0.00
Matched amount	0.00
Settled settlement amount	0.00
Totally settled settlement amount	0.00
Partially settled settlement amount	0.00
Partially cancelled settlement amount	0.00
Totally cancelled settlement amount	0.00

Process information	
Cancellation requested	F
Externally matched	F
CoSD flag	False
Partial settlement indicator	
Priority	
Allowed modification flag	T
Corporate action event identification	
Opt-out settlement transaction condition indicator	F
External CSD flag	F
Original/counterpart instruction	NAPP
Link instruction counter	0
Trade information	
Trade date	2023-07-04
Original ordered amount	0.00
Original ordered currency	
Number of days accrued	1
CUMEX indicator	
Deal price value type	
Deal price yielded	
Deal price value rate	0
Deal price value amount	0.00
Deal price value currency	
Foreign exchange unit currency	
Foreign exchange quoted currency	
Foreign exchange exchange rate	0
Foreign exchange resulting amount	0.00
Foreign exchange resulting amount currency	
Place of trade MIC identifier	
Place of trade description	
Market type code	
Market type proprietary Id	
Market type schema name	
Market type issuer name	
Market client side code	
LCMM information	
LCMM approval status	APPR
LCMM sending party short name	CSD-AT-Range8 - AB
LCMM instructing party short name	CSD-AT-Range8 - AB
LCMM execution/final settlement date	
LCMM user login name	C8AT09129CSD
LCMM inbound LCMM message Id	2307030528304088
LCMM inbound LCMM message ref	1018465850
LCMM validation starting timestamp	2023-07-03 17:33:44.901
LCMM validation ending timestamp	2023-07-03 17:33:46.711
LCMM entry business date	2023-07-03
POOL instruction counter	0
POOL settlement date	
POOL identification	0

Illustration 323: INX01 output screen{CR-819}

**Field
Description**

INX01 – Individual settlement detailed report – Output Screen (These columns will be shown for every instruction selected in the prompt screen)	
Reference information	
T2S actor instruction reference	Shows the reference provided by the T2S actor

INX01 – Individual settlement detailed report – Output Screen (These columns will be shown for every instruction selected in the prompt screen)	
Account servicer reference	Shows the reference provided by the T2S actor when the instruction is sent by an account servicer.
Account owner reference	Shows the reference provided by the T2S actor when the instruction is sent by an account owner.
Third party reference	Shows the reference provided by the T2S actor when the instruction is sent by a third party.
Common reference	<u>Shows the common reference for already-matched instructions. Reference provided by the instructing party when the settlement instruction is already – matched or in order to facilitate the matching within T2S.{CR-819}</u>
Repo reference	Shows the repo reference.
Status information	
Instruction overall final status	Shows the final status. Possible values: <input type="checkbox"/> “Totally settled” <input type="checkbox"/> “Partially settled” <input type="checkbox"/> “Totally cancelled”
Match status	Shows if the settlement instruction is matched with a counterpart settlement instruction. Possible values: <input type="checkbox"/> NMAT (unmatched) <input type="checkbox"/> MACH (matched)
Settlement status	Shows the settlement status Possible values: <input type="checkbox"/> USET (unsettled) <input type="checkbox"/> PSET (partially settled) <input type="checkbox"/> SETT (fully settled)
Cancellation status	Shows the cancellation status Possible values: <input type="checkbox"/> NCAN (not cancelled) <input type="checkbox"/> CANC (cancelled)

INX01 – Individual settlement detailed report – Output Screen (These columns will be shown for every instruction selected in the prompt screen)	
CoSD hold status	Shows the CoSD hold status if the settlement instruction fulfils at least one CoSD rule. Possible values: <input type="checkbox"/> Released <input type="checkbox"/> On hold
CSD hold status	Shows the CSD hold status Possible values: <input type="checkbox"/> Released <input type="checkbox"/> On hold
Party hold status	Shows the party hold status Possible values: <input type="checkbox"/> Released <input type="checkbox"/> On hold
CSD validation hold status	Shows the CSD validation hold status Possible values: <input type="checkbox"/> Released <input type="checkbox"/> On hold
Timeline information	
Entry date time	Shows the date when the settlement instruction entered the T2S system. Display format is: YYYY-MM-DD hh:mm:ss,sssss
Intended settlement date	Shows the intended settlement date. Display format is: YYYY-MM-DD
Actual settlement date	Shows the actual settlement date, if applicable. Display format is: YYYY-MM-DD
Cancellation date	Shows the date when the settlement instruction was cancelled, if applicable. Display format is: YYYY-MM-DD
Categorisation information	
Securities movement type code	Shows the direction of movement required by the settlement instruction. Possible values: <input type="checkbox"/> DELI (deliver)

INX01 – Individual settlement detailed report – Output Screen (These columns will be shown for every instruction selected in the prompt screen)	
	<input type="checkbox"/> RECE (receive)
Payment type code	Shows if cash settlement is also involved. Possible values: <ul style="list-style-type: none"> <input type="checkbox"/> APMT (against payment) <input type="checkbox"/> FREE (free of payment)
Transaction type code	Shows the transaction type code. Possible values: <ul style="list-style-type: none"> <input type="checkbox"/> DVP (delivery versus payment) <input type="checkbox"/> DWP (delivery with payment) <input type="checkbox"/> FOP (free of payment) <input type="checkbox"/> PFOD (payment freed of delivery)
Settlement transaction category	Shows the transaction category. Possible values: <ul style="list-style-type: none"> <input type="checkbox"/> COLA (collateral) <input type="checkbox"/> CORE (collateral relocation) <input type="checkbox"/> LQTR (liquidity transfer) <input type="checkbox"/> REAL (realignment) <input type="checkbox"/> RSMG (restriction management) <input type="checkbox"/> RESU (restriction use) <input type="checkbox"/> RCOL (reverse collateral) <input type="checkbox"/> STND (standard) <input type="checkbox"/> TCAT (technical cash transfer) <input type="checkbox"/> COTF (conditional technical FOP)
Settlement transaction sub-category	Shows the transaction sub-category. Possible values: <ul style="list-style-type: none"> <input type="checkbox"/> CATR (cash transfer) <input type="checkbox"/> COBS (CoSD blocking position – setup) <input type="checkbox"/> PLED (pledge) <input type="checkbox"/> REAL (realignment) <input type="checkbox"/> REPO (repo)

INX01 – Individual settlement detailed report – Output Screen (These columns will be shown for every instruction selected in the prompt screen)	
	<input type="checkbox"/> STND (standard) <input type="checkbox"/> SPLE (sub-pledge)
ISO transaction code	Shows the ISO transaction code. Possible values: <ul style="list-style-type: none"> <input type="checkbox"/> AUTO (auto-collateralisation) <input type="checkbox"/> BSBK (buy sell back) <input type="checkbox"/> CLAI (market claim) <input type="checkbox"/> CNCB (cenrl bank collateral operation) <input type="checkbox"/> COLI (collateral in) <input type="checkbox"/> COLO (collateral out) <input type="checkbox"/> CONV (depository receipt conversion) <input type="checkbox"/> CORP (corporate action) <input type="checkbox"/> FCTA (factor update) <input type="checkbox"/> INSP (movement of stock) <input type="checkbox"/> ISSU (depository receipt issue) <input type="checkbox"/> MKDW (markdown) <input type="checkbox"/> MKUP (markup) <input type="checkbox"/> NETT (netting) <input type="checkbox"/> NSYN (non-syndicated) <input type="checkbox"/> OWNE (external account transfer) <input type="checkbox"/> OWNI (internal account transfer) <input type="checkbox"/> PAIR (pair-off) <input type="checkbox"/> PLAC (placement) <input type="checkbox"/> PORT (portfolio move) <input type="checkbox"/> REAL (realignment) <input type="checkbox"/> REDI (withdrawal) <input type="checkbox"/> REDM (redemption) <input type="checkbox"/> RELE (depository receipt release cancellation) <input type="checkbox"/> REPU (repo) <input type="checkbox"/> RODE (return delivery without matching)

INX01 – Individual settlement detailed report – Output Screen (These columns will be shown for every instruction selected in the prompt screen)	
	<input type="checkbox"/> RPTO (reporting) <input type="checkbox"/> RVPO (reverse repo) <input type="checkbox"/> SBBK (sell buyback) <input type="checkbox"/> SBRE (borrowing reallocation) <input type="checkbox"/> SECB (securities borrowing) <input type="checkbox"/> SECL (securities lending) <input type="checkbox"/> SLRE (lending reallocation) <input type="checkbox"/> SUBS (subscription) <input type="checkbox"/> SYND (syndicate underwriters) <input type="checkbox"/> TBAC (TBA closing) <input type="checkbox"/> TRAD (trade) <input type="checkbox"/> TRPO (tri-party repo) <input type="checkbox"/> TRVO (tri-party reverse repo) <input type="checkbox"/> TURN (turnaround)
Collateral instruction type	Shows the collateral instruction type, if applicable. Possible values: <input type="checkbox"/> CRDT (credit instruction) <input type="checkbox"/> RMBT (reimbursement collateral instruction)
Collateral type	Shows the collateral type, if applicable. Possible values: <input type="checkbox"/> CLNT (client collateralisation) <input type="checkbox"/> NCBC (NCB collateralisation)
Securities information	
ISIN code	Shows the ISIN.
Account owner BIC	Shows the BIC of the securities account owner as per the SI.
Securities account number	Shows the impacted securities account number as per the SI,
T2S delivering party securities account number	Shows the securities account number of the T2S delivering party.

INX01 – Individual settlement detailed report – Output Screen (These columns will be shown for every instruction selected in the prompt screen)	
T2S receiving party securities account number	Shows the securities account number of the T2S receiving party.
Securities sub balance type	Shows the securities sub balance type.
Settlement type	Shows the settlement type. Possible values: <input type="checkbox"/> NOMI (nominal) <input type="checkbox"/> UNIT (units)
Original settlement quantity	Shows the original settlement quantity.
Settled settlement quantity	Shows the settled settlement quantity.
Totally settled settlement quantity	Shows the settled quantity if the SI is fully settled.
Partially settled settlement quantity	Shows the settled quantity if the SI is only partially settled.
Partially cancelled settlement quantity	Shows the remaining unsettled quantity if the SI is only partially settled
Totally cancelled settlement quantity	Shows the unsettled quantity if the SI is completely cancelled.
Securities party information	
Delivering depository BIC	Shows the BIC of the delivering CSD
T2S delivering party BIC	Shows the BIC of the T2S delivering party.
Delivering settlement party processing reference	Shows the processing reference provided in the delivering settlement party information.
Client of delivering CSD participant BIC	Shows the BIC of the delivering CSD participant's client.
Client of delivering CSD participant Id	Shows the local identifier of the delivering CSD participant's client.

INX01 – Individual settlement detailed report – Output Screen (These columns will be shown for every instruction selected in the prompt screen)	
Client of delivering CSD participant issuer	Shows the issuer of the local identifier of the delivering CSD participant's client.
Client of delivering CSD participant schema name	Shows the schema name of the local identifier of the delivering CSD participant's client.
Receiving depository BIC	Shows the BIC of the receiving CSD.
T2S receiving party BIC	Shows the BIC of the T2S receiving party.
Receiving settlement party processing reference	Shows the processing reference provided in the receiving settlement party information.
Client of receiving CSD participant BIC	Shows the BIC of the receiving CSD participant's client.
Client of receiving CSD participant Id	Shows the local identifier of the receiving CSD participant's client.
Client of receiving CSD participant issuer	Shows the issuer of the local identifier of the receiving CSD participant's client.
Client of receiving CSD participant schema name	Shows the schema name of the local identifier of the receiving CSD participant's client.
Cash information	
(Please note, that this part will be empty for Settlement Instructions with transaction code = FOP)	
Currency code	Shows the currency code.
Credit/debit code	Shows if the settlement instruction involves a debit or credit of cash. Possible values: <input type="checkbox"/> CRDT (credit) <input type="checkbox"/> DBIT (debit)
Debtor party BIC	Shows the BIC of the debtor party.
Creditor party BIC	Shows the BIC of the creditor party.

INX01 – Individual settlement detailed report – Output Screen (These columns will be shown for every instruction selected in the prompt screen)	
T2S dedicated cash account number	Shows the impacted T2S dedicated cash account number.
Debtor T2S dedicated cash account number	Shows T2S dedicated cash account number being debited.
Creditor T2S dedicated cash account number	Shows T2S dedicated cash account number being credited.
Original Instructed settlement amount	Shows the original instructed settlement amount.
Transaction original instructed amount	Shows the original instructed amount as per the transaction.
Matched settlement amount	Shows This is the matched settlement amount as per for the matching process-matched transactions .
Settled settlement amount	Shows the settled settlement amount. {CR-819}
Totally settled settlement amount	Shows the settled amount if the SI is fully settled.
Partially settled settlement amount	Shows the settled amount if the SI is only partially settled
Partially cancelled settlement amount	Shows the unsettled amount if the SI is only partially settled.
Totally cancelled settlement amount	Shows the unsettled amount if the SI is fully cancelled.
Process information	
Cancellation requested	Shows if a cancellation has been requested on the settlement instruction. Possible values: <input type="checkbox"/> False <input type="checkbox"/> True
Externally matched	Shows if the settlement instruction was matched outside T2S. Possible values: <input type="checkbox"/> False

INX01 – Individual settlement detailed report – Output Screen (These columns will be shown for every instruction selected in the prompt screen)	
	<input type="checkbox"/> True
CoSD flag	Shows the CoSD flag if the settlement instruction belongs to a CoSD group. Possible values: <input type="checkbox"/> False <input type="checkbox"/> True
Partial settlement indicator	Shows the partial settlement indicator. Possible values: <input type="checkbox"/> NPAR (partial not allowed) <input type="checkbox"/> PART (partial settlement cash threshold allowed) <input type="checkbox"/> PARC (partial settlement quantity threshold allowed) <input type="checkbox"/> PARQ (partial allowed)
Priority	Shows the priority. Possible values: <input type="checkbox"/> 0001 (reserved) <input type="checkbox"/> 0002 (top) <input type="checkbox"/> 0003 (high) <input type="checkbox"/> 0004 (normal)
Allowed modification flag	Shows the allowed modification flag Possible values: <input type="checkbox"/> False <input type="checkbox"/> True
Corporate action event identification	Shows the corporate action event identification if the SI relates to a corporate action.
Opt-out settlement transaction condition indicator	Shows the opt-out settlement transaction condition indicator. Possible values: <input type="checkbox"/> False <input type="checkbox"/> True
External CSD flag	Shows whether the relevant depository is an external CSD.

INX01 – Individual settlement detailed report – Output Screen (These columns will be shown for every instruction selected in the prompt screen)	
	Possible values: False True
Original/counterpart instruction	Shows whether it is the original instruction or the identifier of the counterpart's instructions.
Link instruction counter	Shows the number of instructions linked to this settlement instruction.
Trade information	
Trade date	Shows the trade date of the settlement instruction. Display format is: YYYY-MM-DD
Original ordered amount	Shows the original ordered amount in the original currency when a conversion from/into another currency has occurred.
Original ordered currency	Shows the original ordered currency when a conversion from/into another currency has occurred.
Number of days accrued	Shows the number of days for which interest has accrued.
CUM/EX indicator	Shows whether the contract was traded cum or ex coupon Possible values: <input type="checkbox"/> CUM (cum coupon) <input type="checkbox"/> EX (ex coupon)
Deal price value type	Shows the type of value in which the price of the traded financial instrument is expressed. Possible values: <input type="checkbox"/> DISC (discount) <input type="checkbox"/> PREM (premium) <input type="checkbox"/> PARV (par or face amount)
Deal price yielded	Shows whether the price is expressed as a yield. Possible values: <input type="checkbox"/> False <input type="checkbox"/> True

INX01 – Individual settlement detailed report – Output Screen (These columns will be shown for every instruction selected in the prompt screen)	
Deal price value rate	Shows the deal price value expressed as a rate or percentage when not expressed as an amount.
Deal price value amount	Shows the deal price value expressed as an amount when not expressed as a rate.
Deal price value currency	Shows the deal price value currency when not expressed as a rate.
Foreign exchange unit currency	Shows the currency in which the rate of exchange is expressed in a currency exchange.
Foreign exchange quoted currency	Shows the currency into which the base currency is converted in a currency exchange.
Foreign exchange exchange rate	Shows the factor for the currency exchange.
Foreign exchange resulting amount	Shows the amount resulting from the currency exchange.
Foreign exchange resulting amount currency	Shows the currency of the amount resulting from the currency exchange.
Place of trade MIC identifier	Shows the market identifier code of the place of trade.
Place of trade description	Shows the description of the place of trade.
Market type code	Shows the market type code.
Market type proprietary Id	Shows the proprietary id of the market type when not using the ISO market type code.
Market type schema name	Shows the schema name associated with the proprietary id of the market type when not using the ISO market type code.
Market type issuer name	Shows the issuer name associated with the proprietary id of the market type when not using the ISO market type code.
Market client side code	Shows the market side code. Possible values: <input type="checkbox"/> CLNT (client side transaction) <input type="checkbox"/> MAKT (market side transaction)

INX01 – Individual settlement detailed report – Output Screen (These columns will be shown for every instruction selected in the prompt screen)	
LCMM information	
LCMM approval status	Shows the LCMM approval status. Possible values: <input type="checkbox"/> APPR (approved (default value)) <input type="checkbox"/> AWAP (awaiting approval) <input type="checkbox"/> REJT (rejected) <input type="checkbox"/> RVKD (revoked)
LCMM sending party short name	Shows the sending party short name
LCMM instructing party short name	Shows the instructing party short name
LCMM execution/final settlement date	Shows the business date when the SI is totally settled. Displayed format is : YYYY-MM-DD.
LCMM user login name	Shows the login name of the LCMM user.
LCMM inbound LCMM message Id	Shows the foreign key of the LCMM inbound message id.
LCMM inbound LCMM message ref	Shows the reference of the LCMM inbound message.
LCMM validation starting timestamp	Shows the LCMM validation starting timestamp. Display format is: YYYY-MM-DD hh:mm:ss,sssss
LCMM validation ending timestamp	Shows the LCMM validation ending timestamp. Displayed format is: YYYY-MM-DD hh:mm:ss,sssss
LCMM entry business date	Shows the LCMM entry business date. Displayed format is: YYYY-MM-DD
POOL instruction counter	Shows the number of instructions that make up a pool as identified on the settlement instruction.
POOL settlement date	Shows the pool settlement date. Displayed format is: YYYY-MM-DD

INX01 – Individual settlement detailed report – Output Screen (These columns will be shown for every instruction selected in the prompt screen)	
POOL identification	Shows the reference identifying a pool as found on the settlement instruction. ⁷⁷

5.5.3.2 INX02 – Multi-criteria search of a set of settlement instructions

Context of Usage

This report shows a list of details for selected finalised business settlement instructions (SI), which it performs in two levels. In the first level, the report produces a list of SIs corresponding to user-supplied filter criteria. In the second level, the user may select one SI from the list and the detailed report provides a full list of attributes of the selected SI.

The attributes shown in the detailed report output provide business details related to the selected SI.

This report can be used by CSD, ~~CSDP and ECSD~~ users. {CR-819}

Report Access

This report can be reached in the following way:

- [Content >>](#) Team Content >> [T2S >>](#) Predefined Reports >> [INX](#)
: T2S Instructions >> INX02 {CR-819}

⁷⁷ This content is not applicable as of R6.2, and will become applicable upon the deployment of the Data Warehouse for T2S.

Screenshot

Illustration 324: **INX02 pre-selection screen** {CR-819}

Field
Description

INX02 – Multi-criteria search of a set of settlement instructions – Pre-selection screen	
Choose data object	
(one of both objects has to be chosen)	
Party BIC	Provides fields for searching securities party BICs or cash party BICs in the next screen

INX02 – Multi-criteria search of a set of settlement instructions – Pre-selection screen	
Account number	Provides fields for searching for securities account numbers or cash account numbers in the next screen
Additional search criteria (both objects are optional)	
Quantity of securities	Provides fields for searching different quantity ranges in the next screen
Amounts	Provides fields for searching different amount ranges in the next screen

Screenshot

INX02 – Prompt

Securities party BIC:

Keywords:

- Select all
- CSDACXMMXXX
- CSDAESLRXX0
- CSDAESLRXX0
- CSDAESLRXX0
- CSDAESPAAAA
- CSDAESPAAAA
- CSDAESPAXXX

Starts with any of these keywords ▾

Case Insensitive

Please search and select the securities party BIC

- CSDACXMMXXX
- CSDAESLRXX0
- CSDAESLRXX0
- CSDAESLRXX0
- CSDAESPAAAA
- CSDAESPAAAA
- CSDAESPAXXX
- CSDAESPAXXX
- CSDAESPAXXX
- CSDAESPAXXX
- CSDAESPJXXO
- CSDAESPJXXO
- CSDAESPXXXX

[Select all](#) [Deselect all](#)

Cash party BIC:

Keywords:

- Select all
- No Results

Starts with any of these keywords ▾

Case Insensitive

Please search and select the cash party BIC

[Select all](#) [Deselect all](#)

ISIN:

Keywords:

- Select all
- No Results

Starts with any of these keywords ▾

Case Insensitive

Please search and select the ISIN

[Select all](#) [Deselect all](#)

Settlement type:

NOMI

UNIT

Settlement currency code:	DKK EUR	
Securities movement type code:	DELI RECE	
Transaction type code:	DVP DWP FOP PFOD	
Settlement transaction category:	COLA CORE LQTR REAL	
Settlement transaction sub-category:	CATR COBS PLED REAL	
LCMM approval status:	APPR AWAP REJT RVKD	
Settlement status:	USET PSET SETT	
Cancellation status:	NCAN CANC	
Range criteria	From	To
Entry date:	Jun 1, 2023	Sep 18, 2023
Intended settlement date:	Jun 1, 2023	Sep 18, 2023
<input type="button" value="Cancel"/> <input type="button" value=" < Back"/> <input type="button" value="Next >"/> <input type="button" value="Finish"/>		

Illustration 325: INX02 prompt screen{CR-819}

Field Description

INX02 – Multi-criteria search of a set of settlement instructions – Prompt Screen	
Securities party BIC	Filter to select which securities party BIC (CSDs, CSD participants or ECSDs) value/s should be included in the output.
Cash party BIC	Filter to select which cash party BIC (NCB or payment bank) value/s should be included in the output.

INX02 – Multi-criteria search of a set of settlement instructions – Prompt Screen	
Securities account number	Filter to select which securities account number value/s should be included in the output.
T2S DCA number	Multiple selection text field to enter T2S DCA number value/s that should be included in the output.
ISIN	Filter to select which ISIN value/s should be included in the output.
Settlement type	Filter to select which settlement type value/s should be included in the output. Possible values: <input type="checkbox"/> NOMI <input type="checkbox"/> UNIT
Settlement currency code	The report output contains only settlement instructions with the selected settlement currency codes.
Securities movement type code	Filter to select which securities movement type code value/s should be included in the output. Possible values: <input type="checkbox"/> DELI <input type="checkbox"/> RECE
Transaction type code	Filter to select which transaction type code value/s should be included in the output. Possible values: <input type="checkbox"/> DVP <input type="checkbox"/> DWP <input type="checkbox"/> FOP <input type="checkbox"/> PFOD
Settlement transaction category	Filter to select which settlement transaction category value/s should be included in the output. Possible values: <input type="checkbox"/> COLA <input type="checkbox"/> CORE <input type="checkbox"/> LQTR <input type="checkbox"/> REAL <input type="checkbox"/> RSMG <input type="checkbox"/> RESU <input type="checkbox"/> RCOL <input type="checkbox"/> STND

INX02 – Multi-criteria search of a set of settlement instructions – Prompt Screen	
	<input type="checkbox"/> TCAT <input type="checkbox"/> COTF
Settlement transaction sub-category	Filter to select which settlement transaction sub-category value/s should be included in the output. Possible values: <input type="checkbox"/> CATR <input type="checkbox"/> COBS <input type="checkbox"/> PLED <input type="checkbox"/> REAL <input type="checkbox"/> REPO <input type="checkbox"/> STND <input type="checkbox"/> SPLE
LCMM approval status	Filter to select which LCMM approval status value/s should be included in the output. Possible values: <input type="checkbox"/> APPR <input type="checkbox"/> AWAP <input type="checkbox"/> REJT <input type="checkbox"/> RVKD
Settlement status	Filter to select which settlement status value/s should be included in the output. Possible values: <input type="checkbox"/> USET <input type="checkbox"/> PSET <input type="checkbox"/> SETT
Cancellation status	Filter to select which cancellation status value/s should be included in the output. Possible values: <input type="checkbox"/> NCAN <input type="checkbox"/> CANC
Entry date from	Filter to select the inclusive date from which entry date value/s should be included in the output.

INX02 – Multi-criteria search of a set of settlement instructions – Prompt Screen	
	<p>Must be used in conjunction with:</p> <p><input type="checkbox"/> entry date to</p>
Entry date to	<p>Filter to select the inclusive date up to which entry date value/s should be included in the output.</p> <p>Must be used in conjunction with:</p> <p><input type="checkbox"/> entry date from</p>
Intended settlement date from	<p>Filter to select the inclusive date from which intended settlement date value/s should be included in the output.</p> <p>Must be used in conjunction with:</p> <p><input type="checkbox"/> intended settlement date to</p>
Intended settlement date to	<p>Filter to select the inclusive date up to which intended settlement date value/s should be included in the output.</p> <p>Must be used in conjunction with:</p> <p><input type="checkbox"/> intended settlement date from</p>
<p>The following criteria are only shown in case that “Quantity of securities” was chosen as additional search criteria</p>	
Original quantity from	<p>Filter to select the inclusive quantity from which original quantity value/s should be included in the output.</p> <p>Must be used in conjunction with:</p> <p><input type="checkbox"/> original quantity to</p>
Original quantity to	<p>Filter to select the inclusive quantity up to which original quantity value/s should be included in the output.</p> <p>Must be used in conjunction with:</p> <p><input type="checkbox"/> original quantity from</p>
Settled quantity from	<p>Filter to select the inclusive quantity from which settled quantity value/s should be included in the output.</p>

INX02 – Multi-criteria search of a set of settlement instructions – Prompt Screen	
	<p>Must be used in conjunction with:</p> <p><input type="checkbox"/> settled quantity to</p>
Settled quantity to	<p>Filter to select the inclusive quantity up to which settled quantity value/s should be included in the output.</p> <p>Must be used in conjunction with:</p> <p><input type="checkbox"/> settled quantity from</p>
Cancelled quantity from	<p>Filter to select the inclusive quantity from which cancelled quantity value/s should be included in the output.</p> <p>Must be used in conjunction with:</p> <p><input type="checkbox"/> cancelled quantity to</p>
Cancelled quantity to	<p>Filter to select the inclusive quantity up to which cancelled quantity value/s should be included in the output.</p> <p>Must be used in conjunction with:</p> <p><input type="checkbox"/> cancelled quantity from</p>
The following criteria are only shown in case that “Amounts” was chosen as additional search criteria	
Original amount from	<p>Filter to select the inclusive amount from which original amount value/s should be included in the output.</p> <p>Must be used in conjunction with:</p> <p><input type="checkbox"/> original amount to</p>
Original amount to	<p>Filter to select the inclusive amount up to which original amount value/s should be included in the output.</p> <p>Must be used in conjunction with:</p> <p><input type="checkbox"/> original amount from</p>
Settled amount from	<p>Filter to select the inclusive amount from which settled amount value/s should be included in the output.</p> <p>Must be used in conjunction with:</p>

INX02 – Multi-criteria search of a set of settlement instructions – List Screen	
T2S actor instruction reference	Shows the reference provided by the T2S actor The reference is built as a hyperlink which leads to the output details screen when clicked.
Securities movement type code	Shows the direction of movement required by the settlement instruction. Possible values: <input type="checkbox"/> DELI (deliver) <input type="checkbox"/> RECE (receive)
Payment type code	Shows if cash settlement is also involved. Possible values: <input type="checkbox"/> APMT (against payment) <input type="checkbox"/> FREE (free of payment)
Intended settlement date	Shows the intended settlement date.
Actual settlement date	Shows the actual settlement date.
Cancellation date	Shows the date when the settlement instruction was cancelled. Display format is: YYYY-MM-DD
Match status	Shows if the settlement instruction is matched with a counterpart settlement instruction. Possible values: <input type="checkbox"/> NMAT (unmatched) <input type="checkbox"/> MACH (matched)
Settlement status	Shows the settlement status Possible values: <input type="checkbox"/> USET (unsettled) <input type="checkbox"/> PSET (partially settled) <input type="checkbox"/> SETT (fully settled)
Cancellation status	Shows the cancellation status Possible values: <input type="checkbox"/> NCAN (not cancelled) <input type="checkbox"/> CANC (cancelled)
ISIN code	Shows the ISIN.

INX02 – Multi-criteria search of a set of settlement instructions – List Screen	
Settlement type	Shows the settlement type. Possible values: <ul style="list-style-type: none"><input type="checkbox"/> NOMI (nominal)<input type="checkbox"/> UNIT (units)
Original settlement quantity	Shows the original settlement quantity.
Settled settlement quantity	Shows the settled settlement quantity.
Currency code	Shows the currency code.
Credit/debit code	Shows if the settlement instruction involves a debit or credit of cash. Possible values: <ul style="list-style-type: none"><input type="checkbox"/> CRDT (credit)<input type="checkbox"/> DBIT (debit)
Original Instructed settlement amount	Shows the original instructed settlement amount. {CR-819}
Matched settlement amount	Shows the matched amount as per the matching process..
Settled settlement amount	Shows the settled settlement amount.
Transaction type code	Shows the transaction type code. Possible values: <ul style="list-style-type: none"><input type="checkbox"/> DVP (delivery versus payment)<input type="checkbox"/> DWP (delivery with payment)<input type="checkbox"/> FOP (free of payment)<input type="checkbox"/> PFOD (payment freed of delivery)
Settlement transaction category	Shows the transaction category. Possible values: <ul style="list-style-type: none"><input type="checkbox"/> COLA (collateral)<input type="checkbox"/> CORE (collateral relocation)<input type="checkbox"/> LQTR (liquidity transfer)<input type="checkbox"/> REAL (realignment)<input type="checkbox"/> RSMG (restriction management)

INX02 – Multi-criteria search of a set of settlement instructions – List Screen	
	<ul style="list-style-type: none"> <input type="checkbox"/> RESU (restriction use) <input type="checkbox"/> RCOL (reverse collateral) <input type="checkbox"/> STND (standard) <input type="checkbox"/> TCAT (technical cash transfer) <input type="checkbox"/> COTF (conditional technical FOP)
Settlement transaction sub-category	<p>Shows the transaction sub-category.</p> <p>Possible values:</p> <ul style="list-style-type: none"> <input type="checkbox"/> CATR (cash transfer) <input type="checkbox"/> COBS (CoSD blocking position – setup) <input type="checkbox"/> PLED (pledge) <input type="checkbox"/> REAL (realignment) <input type="checkbox"/> REPO (repo) <input type="checkbox"/> STND (standard) <input type="checkbox"/> SPLE (sub-pledge)
ISO transaction code	<p>Shows the ISO transaction code.</p> <p>Possible values:</p> <ul style="list-style-type: none"> <input type="checkbox"/> AUTO (auto-collateralisation) <input type="checkbox"/> BSBK (buy sell back) <input type="checkbox"/> CLAI (market claim) <input type="checkbox"/> CNCB (cenrl bank collateral operation) <input type="checkbox"/> COLI (collateral in) <input type="checkbox"/> COLO (collateral out) <input type="checkbox"/> CONV (depository receipt conversion) <input type="checkbox"/> CORP (corporate action) <input type="checkbox"/> FCTA (factor update) <input type="checkbox"/> INSP (movement of stock) <input type="checkbox"/> ISSU (depository receipt issue) <input type="checkbox"/> MKDW (markdown) <input type="checkbox"/> MKUP (markup) <input type="checkbox"/> NETT (netting) <input type="checkbox"/> NSYN (non-syndicated)

INX02 – Multi-criteria search of a set of settlement instructions – List Screen	
	<input type="checkbox"/> OWNE (external account transfer) <input type="checkbox"/> OWNI (internal account transfer) <input type="checkbox"/> PAIR (pair-off) <input type="checkbox"/> PLAC (placement) <input type="checkbox"/> PORT (portfolio move) <input type="checkbox"/> REAL (realignment) <input type="checkbox"/> REDI (withdrawal) <input type="checkbox"/> REDM (redemption) <input type="checkbox"/> RELE (depository receipt release cancellation) <input type="checkbox"/> REPU (repo) <input type="checkbox"/> RODE (return delivery without matching) <input type="checkbox"/> RPTO (reporting) <input type="checkbox"/> RVPO (reverse repo) <input type="checkbox"/> SBBK (sell buyback) <input type="checkbox"/> SBRE (borrowing reallocation) <input type="checkbox"/> SECB (securities borrowing) <input type="checkbox"/> SECL (securities lending) <input type="checkbox"/> SLRE (lending reallocation) <input type="checkbox"/> SUBS (subscription) <input type="checkbox"/> SYND (syndicate underwriters) <input type="checkbox"/> TBAC (TBA closing) <input type="checkbox"/> TRAD (trade) <input type="checkbox"/> TRPO (tri-party repo) <input type="checkbox"/> TRVO (tri-party reverse repo) <input type="checkbox"/> TURN (turnaround)
CSD BIC	Shows the BIC of the related CSD
CSD participant BIC	Shows the BIC of the T2S participant.
Securities account number	Shows the impacted securities account number as per the SI,
NCB BIC	Shows the parent party BIC of the payment bank (if applicable)
Payment bank BIC	Shows the BIC of the cash account owner (if applicable)

INX02 – Multi-criteria search of a set of settlement instructions – List Screen

T2S DCA number	Shows the T2S cash account used for settlement (if applicable)
----------------	--

Screenshot

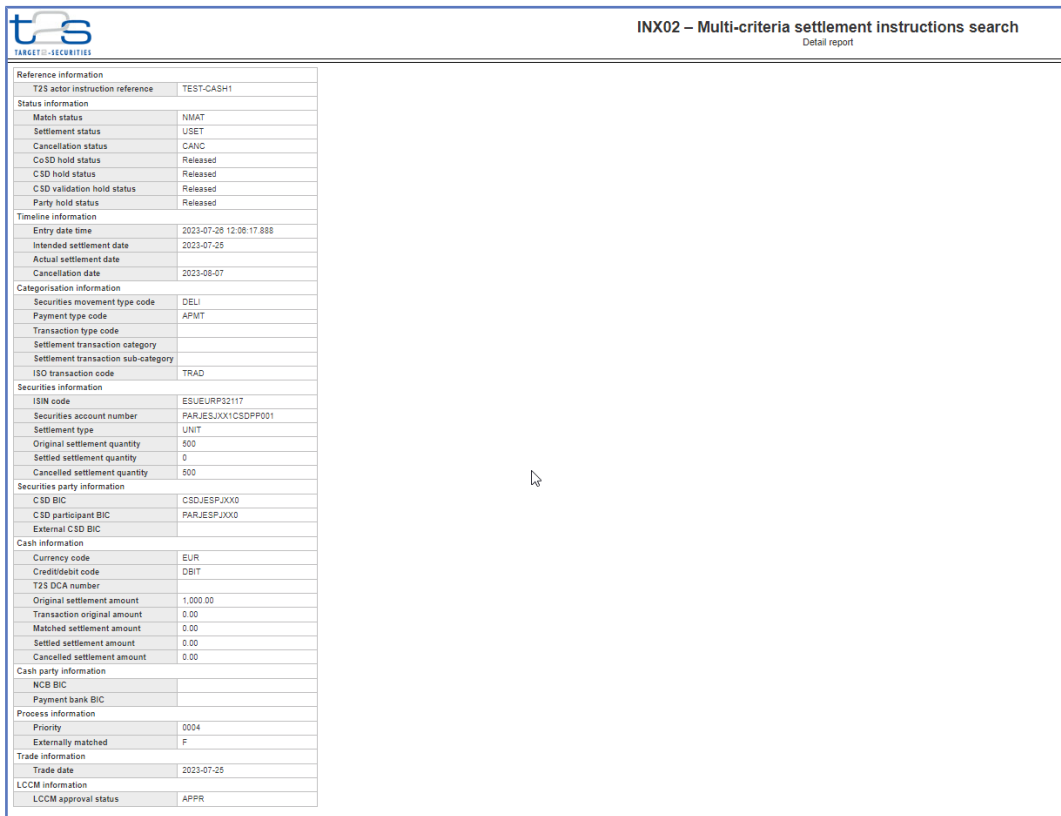

Illustration 327: INX02 details screen{CR-819}

INX02 – Multi-criteria search of a set of settlement instructions – Details Screen

Field Description

Reference information	
T2S actor instruction reference	Shows the reference provided by the T2S actor
Status information	
Match status	Shows if the settlement instruction is matched with a counterpart settlement instruction. Possible values: <input type="checkbox"/> NMAT (unmatched) <input type="checkbox"/> MACH (matched)
Settlement status	Shows the settlement status Possible values: <input type="checkbox"/> USET (unsettled)

INX02 – Multi-criteria search of a set of settlement instructions – Details Screen	
	<input type="checkbox"/> PSET (partially settled) <input type="checkbox"/> SETT (fully settled)
Cancellation status	Shows the cancellation status Possible values: NCAN (not cancelled) CANC (cancelled)
CoSD hold status	Shows the CoSD hold status if the settlement instruction fulfils at least one CoSD rule. Possible values: <input type="checkbox"/> Released <input type="checkbox"/> On hold
CSD hold status	Shows the CSD hold status Possible values: <input type="checkbox"/> Released <input type="checkbox"/> On hold
CSD validation hold status	Shows the CSD validation hold status Possible values: <input type="checkbox"/> Released <input type="checkbox"/> On hold
Party hold status	Shows the party hold status Possible values: <input type="checkbox"/> Released <input type="checkbox"/> On hold
Timeline information	
Entry date	Shows the date when the settlement instruction entered the T2S system. Display format is: YYYY-MM-DD
Intended settlement date	Shows the intended settlement date. Display format is: YYYY-MM-DD
Actual settlement date	Shows the actual settlement date, if applicable. Display format is: YYYY-MM-DD
Cancellation date	Shows the date when the settlement instruction was cancelled, if applicable. Display format is: YYYY-MM-DD
Categorisation information	

INX02 – Multi-criteria search of a set of settlement instructions – Details Screen	
Securities movement type code	Shows the direction of movement required by the settlement instruction. Possible values: <ul style="list-style-type: none"><input type="checkbox"/> DELI (deliver)<input type="checkbox"/> RECE (receive)
Payment type code	Shows if cash settlement is also involved. Possible values: <ul style="list-style-type: none"><input type="checkbox"/> APMT (against payment)<input type="checkbox"/> FREE (free of payment)
Transaction type code	Shows the transaction type code. Possible values: <ul style="list-style-type: none"><input type="checkbox"/> DVP (delivery versus payment)<input type="checkbox"/> DWP (delivery with payment)<input type="checkbox"/> FOP (free of payment)<input type="checkbox"/> PFOD (payment freed of delivery)
Settlement transaction category	Shows the transaction category. Possible values: <ul style="list-style-type: none"><input type="checkbox"/> COLA (collateral)<input type="checkbox"/> CORE (collateral relocation)<input type="checkbox"/> LQTR (liquidity transfer)<input type="checkbox"/> REAL (realignment)<input type="checkbox"/> RSMG (restriction management)<input type="checkbox"/> RESU (restriction use)<input type="checkbox"/> RCOL (reverse collateral)<input type="checkbox"/> STND (standard)<input type="checkbox"/> TCAT (technical cash transfer)<input type="checkbox"/> COTF (conditional technical FOP)
Settlement transaction sub-category	Shows the transaction sub-category. Possible values: <ul style="list-style-type: none"><input type="checkbox"/> CATR (cash transfer)<input type="checkbox"/> COBS (CoSD blocking position – setup)<input type="checkbox"/> PLED (pledge)

INX02 – Multi-criteria search of a set of settlement instructions – Details Screen	
	<ul style="list-style-type: none"> <input type="checkbox"/> REAL (realignment) <input type="checkbox"/> REPO (repo) <input type="checkbox"/> STND (standard) <input type="checkbox"/> SPLE (sub-pledge)
ISO transaction code	<p>Shows the ISO transaction code.</p> <p>Possible values:</p> <ul style="list-style-type: none"> <input type="checkbox"/> AUTO (auto-collateralisation) <input type="checkbox"/> BSBK (buy sell back) <input type="checkbox"/> CLAI (market claim) <input type="checkbox"/> CNCB (cenrl bank collateral operation) <input type="checkbox"/> COLI (collateral in) <input type="checkbox"/> COLO (collateral out) <input type="checkbox"/> CONV (depository receipt conversion) <input type="checkbox"/> CORP (corporate action) <input type="checkbox"/> FCTA (factor update) <input type="checkbox"/> INSP (movement of stock) <input type="checkbox"/> ISSU (depository receipt issue) <input type="checkbox"/> MKDW (markdown) <input type="checkbox"/> MKUP (markup) <input type="checkbox"/> NETT (netting) <input type="checkbox"/> NSYN (non-syndicated) <input type="checkbox"/> OWNE (external account transfer) <input type="checkbox"/> OWNI (internal account transfer) <input type="checkbox"/> PAIR (pair-off) <input type="checkbox"/> PLAC (placement) <input type="checkbox"/> PORT (portfolio move) <input type="checkbox"/> REAL (realignment) <input type="checkbox"/> REDI (withdrawal) <input type="checkbox"/> REDM (redemption) <input type="checkbox"/> RELE (depository receipt release cancellation) <input type="checkbox"/> REPU (repo)

INX02 – Multi-criteria search of a set of settlement instructions – Details Screen	
	<input type="checkbox"/> RODE (return delivery without matching) <input type="checkbox"/> RPTO (reporting) <input type="checkbox"/> RVPO (reverse repo) <input type="checkbox"/> SBBK (sell buyback) <input type="checkbox"/> SBRE (borrowing reallocation) <input type="checkbox"/> SECB (securities borrowing) <input type="checkbox"/> SECL (securities lending) <input type="checkbox"/> SLRE (lending reallocation) <input type="checkbox"/> SUBS (subscription) <input type="checkbox"/> SYND (syndicate underwriters) <input type="checkbox"/> TBAC (TBA closing) <input type="checkbox"/> TRAD (trade) <input type="checkbox"/> TRPO (tri-party repo) <input type="checkbox"/> TRVO (tri-party reverse repo) <input type="checkbox"/> TURN (turnaround)
Securities information	
ISIN code	Shows the ISIN.
Securities account number	Shows the impacted securities account number as per the SI,
Settlement type	Shows the settlement type. Possible values: <input type="checkbox"/> NOMI (nominal) <input type="checkbox"/> UNIT (units)
Original settlement quantity	Shows the original settlement quantity.
Settled settlement quantity	Shows the settled settlement quantity.
Cancelled settlement quantity	Shows the unsettled quantity if the SI is not completely settled.
Securities party information	
CSD BIC	Shows the BIC of the CSD
CSD participant BIC	Shows the BIC of the CSD participant.

INX02 – Multi-criteria search of a set of settlement instructions – Details Screen	
External CSD BIC	Shows the BIC of the external CSD (ECSD)
Cash information	
(Please note, that this part will be empty for Settlement Instructions with transaction code = FOP)	
Currency code	Shows the currency code.
Credit/debit code	Shows if the settlement instruction involves a debit or credit of cash. Possible values: <input type="checkbox"/> CRDT (credit) <input type="checkbox"/> DBIT (debit)
T2S dedicated cash account number	Shows the impacted T2S dedicated cash account number.
Original Instructed settlement amount	Shows the original instructed settlement amount. {CR-819}
Transaction original amount	Shows the original amount as per the transaction.
Matched amount	Shows the matched amount as per the matching process..
Settled settlement amount	Shows the settled settlement amount.
Cancelled settlement amount	Shows the cancelled amount if the SI is not completely settled.
Process information	
Priority	Shows the priority. Possible values: <input type="checkbox"/> 0001 (reserved) <input type="checkbox"/> 0002 (top) <input type="checkbox"/> 0003 (high) <input type="checkbox"/> 0004 (normal)
Externally matched	Shows if the settlement instruction was matched outside T2S. Possible values: <input type="checkbox"/> False <input type="checkbox"/> True

INX02 – Multi-criteria search of a set of settlement instructions – Details Screen	
Trade information	
Trade date	Shows the trade date of the settlement instruction. Display format is: YYYY-MM-DD
LCMM information	
LCMM approval status	Shows the LCMM approval status. Possible values: <ul style="list-style-type: none"> <input type="checkbox"/> APPR (approved (default value)) <input type="checkbox"/> AWAP (awaiting approval) <input type="checkbox"/> REJT (rejected) <input type="checkbox"/> RVKD (revoked) ⁷⁸

5.5.3.3 INX03 – Individual restriction detailed report

Context of Usage

This report shows all finalised business settlement restrictions (SR) corresponding to the selected T2S references.

The attributes shown in the output provide business details related to each of the selected settlement restrictions and are displayed in a manner which allows easy comparison between these instructions.

This report can be used by **NCB, PB, CSD, CSDP** and **ECSCB** users. **{CR-819}**

Report Access

This report can be reached in the following way:

- Content >>** Team Content >> **T2S >>** Predefined Reports >> **INX**
- T2S Instructions >> INX03 **{CR-819}**

Screenshot

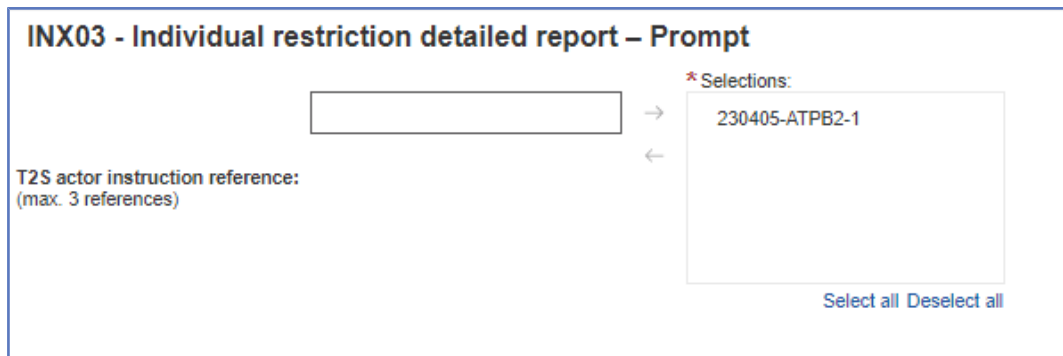

Illustration 328: **INX03 prompt screen** **{CR-819}**

78 This content is not applicable as of R6.2, and will become applicable upon the deployment of the Data Warehouse for T2S.

Field

Description

INX03 – Individual restriction detailed report – Prompt Screen

T2S actor instruction reference

You can use this drop-down field to select one or several T2S actor instruction references. This field will show all related references, which belong to the default data scope of the user’s party.

This field is mandatory.

Screenshot

Reference information	
T2S actor instruction reference	230405-ATPB2-1
Account servicer reference	
Account owner reference	
Third party reference	
Status information	
Restriction overall final status	Totally settled
Settlement status	SETT
Cancellation status	NCAN
Timeline information	
Creation date	2023-04-06
Entry date time	2023-04-05 16:14:59.640
Intended settlement date	2023-04-06
Actual settlement date	2023-04-06
Cancellation date	
Categorisation information	
Movement type	SCTY
Collateral instruction type	
Balance from	AVIAS
Balance to	RESA
Restriction processing type from	Deliverable
Restriction processing type to	Reservation
Securities information	
ISIN code	ATC8AT000018
Account owner BIC	PMBKATFF802
Securities account number	CSDPC8ATPB2001
Settlement type	UNIT
Settlement quantity	111
Settled settlement quantity	111
Totally settled settlement quantity	111
Partially settled settlement quantity	
Partially cancelled settlement quantity	
Totally cancelled settlement quantity	
Cash information	
Currency code	
T2S dedicated cash account number	
Settlement amount	
Settled settlement amount	
Totally settled settlement amount	
Partially settled settlement amount	
Partially cancelled settlement amount	
Totally cancelled settlement amount	

Process information	
CoSD blocking	F
Priority	
Corporate action event identification	
Collateral flag	
End of day restriction release	
Linked instructions counter	
LCMM information	
LCMM approval status	APPR
LCCM sending party short name	PB2-AT as CSDP-AT Range8 - AB
LCCM instructing party short name	PB2-AT as CSDP-AT Range8 - AB
LCMM execution/final settlement date	2023-04-06
LCMM user login name	
LCMM inbound LCMM message Id	2304050525874322
LCMM inbound LCMM message ref	9000000001928982
LCMM validation starting timestamp	2023-04-05 16:14:59.509
LCMM validation ending timestamp	2023-04-05 16:14:59.635
LCMM entry business date	2023-04-05
POOL party short name	
POOL instruction counter	0
POOL settlement date	
POOL identification	0

Illustration 329: INX03 output screen{CR-819}

Field Description	INX03 – Individual restriction detailed report – Output Screen (These columns will be shown for every instruction selected in the prompt screen)	
Reference information		
T2S actor instruction reference	Shows the reference provided by the T2S actor	
Account servicer reference	Shows the reference provided by the T2S actor when the restriction is sent by an account servicer.	
Account owner reference	Shows the reference provided by the T2S actor when the restriction is sent by an account owner.	
Third party reference	Shows the reference provided by the T2S actor when the restriction is sent by a third party.	
Status information		
Restriction overall final status	Shows the final status. Possible values: <input type="checkbox"/> “Totally settled” <input type="checkbox"/> “Partially settled” <input type="checkbox"/> “Totally cancelled”	
Settlement status	Shows the settlement status Possible values: <input type="checkbox"/> USET (unsettled) <input type="checkbox"/> PSET (partially settled) <input type="checkbox"/> SETT (fully settled)	
Cancellation status	Shows the cancellation status Possible values: <input type="checkbox"/> NCAN (not cancelled) <input type="checkbox"/> CANC (cancelled)	
Timeline information		
Creation date	Shows the date when the settlement restriction was created. Display format is: YYYY-MM-DD	
Entry date time	Shows the date when the settlement restriction entered T2S. Display format is: YYYY-MM-DD hh:mm:ss,sssss	
Intended settlement date	Shows the intended settlement date. Display format is: YYYY-MM-DD	

INX03 – Individual restriction detailed report – Output Screen (These columns will be shown for every instruction selected in the prompt screen)	
Actual settlement date	Shows the actual settlement date. Display format is: YYYY-MM-DD
Cancellation date	Shows the date when the settlement restriction was cancelled. Display format is: YYYY-MM-DD
Categorisation information	
Movement type	Shows the movement type of the settlement restriction. Possible values: <input type="checkbox"/> CASH (restriction of cash) <input type="checkbox"/> SCTY (restriction of securities)
Collateral instruction type	Shows the collateral instruction type. Possible values: <input type="checkbox"/> CRDT (credit instruction) <input type="checkbox"/> RMBT (reimbursement collateral instruction)
Balance from	Shows the balance type from which securities or cas are moved
Balance to	Shows the balance type to which securities or cash are moved
Restriction processing type from	Shows the restriction processing type from which the cash/securities are debited/delivered. Possible values: <input type="checkbox"/> Rejection <input type="checkbox"/> CSD Validation Hold <input type="checkbox"/> Reservation <input type="checkbox"/> Blocking <input type="checkbox"/> Balance Type/Earmarking <input type="checkbox"/> Earmarking for Auto-collateralisation <input type="checkbox"/> Deliverable <input type="checkbox"/> Collateralised <input type="checkbox"/> CoSD Blocking
Restriction processing type to	Shows the restriction processing type to which the cash/securities are credited/received. Possible values:

INX03 – Individual restriction detailed report – Output Screen (These columns will be shown for every instruction selected in the prompt screen)	
	<input type="checkbox"/> Rejection <input type="checkbox"/> CSD Validation Hold <input type="checkbox"/> Reservation <input type="checkbox"/> Blocking <input type="checkbox"/> Balance Type/Earmarking <input type="checkbox"/> Earmarking for Auto-collateralisation <input type="checkbox"/> Deliverable <input type="checkbox"/> Collateralised <input type="checkbox"/> CoSD blocking
Securities information (This part will only be filled in case of settlement restrictions on securities)	
ISIN code	Shows the ISIN.
Account owner BIC	Shows the BIC of the securities account owner as per the SR.
Securities account number	Shows the impacted securities account number as per the SR.
Settlement type	Shows the settlement type. Possible values: <input type="checkbox"/> NOMI (nominal) <input type="checkbox"/> UNIT (units)
Settlement quantity	Shows the entered settlement quantity.
Settled settlement quantity	Shows the settled settlement quantity.
Totally settled settlement quantity	Shows the settled quantity if the SR is fully settled.
Partially settled settlement quantity	Shows the settled quantity if the SR is only partially settled.
Partially cancelled settlement quantity	Shows the remaining unsettled quantity if the SR is only partially settled
Totally cancelled settlement quantity	Shows the unsettled quantity if the SR is completely cancelled.
Cash information	

INX03 – Individual restriction detailed report – Output Screen (These columns will be shown for every instruction selected in the prompt screen)	
(This part will only be filled in case of settlement restrictions on cash)	
Currency code	Shows the currency code.
T2S dedicated cash account number	Shows the impacted T2S dedicated cash account number.
Settlement amount	Shows the settlement amount.
Settled settlement amount	Shows the settled settlement amount.
Totally settled settlement amount	Shows the settled amount if the SR is fully settled.
Partially settled settlement amount	Shows the settled amount if the SR is only partially settled.
Partially cancelled settlement amount	Shows the remaining unsettled amount if the SR is only partially settled
Totally cancelled settlement amount	Shows the unsettled amount if the SR is completely cancelled.
Process information	
CoSD blocking	Shows whether the restriction relates to a CoSD blocking. Possible values: <input type="checkbox"/> False <input type="checkbox"/> True
Priority	Shows the priority. Possible values: <input type="checkbox"/> 0001 (reserved) <input type="checkbox"/> 0002 (top) <input type="checkbox"/> 0003 (high) <input type="checkbox"/> 0004 (normal)
Corporate action event identification	Shows the corporate action event identification if the SR relates to a corporate action.
Collateral flag	Shows whether the restriction relates to collateral. Possible values: <input type="checkbox"/> False <input type="checkbox"/> True

INX03 – Individual restriction detailed report – Output Screen (These columns will be shown for every instruction selected in the prompt screen)	
End of day restriction release	Shows whether the restriction relates to an end of day restriction release. Possible values: <input type="checkbox"/> False <input type="checkbox"/> True
Linked instructions counter	Shows the number of instructions linked to this settlement restriction.
LCMM information	
LCMM approval status	Shows the LCMM approval status. Possible values: <input type="checkbox"/> APPR (approved (default value)) <input type="checkbox"/> AWAP (awaiting approval) <input type="checkbox"/> REJT (rejected) <input type="checkbox"/> RVKD (revoked)
LCMM sending party short name	Shows the sending party short name
LCMM instructing party short name	Shows the instructing party short name
LCMM execution/final settlement date	Shows the business date when the SR is totally settled. Displayed format is : YYYY-MM-DD.
LCMM user login name	Shows the login name of the LCMM user.
LCMM inbound LCMM message Id	Shows the foreign key of the LCMM inbound message id.
LCMM inbound LCMM message ref	Shows the reference of the LCMM inbound message.
LCMM validation starting timestamp	Shows the LCMM validation starting timestamp. Display format is: YYYY-MM-DD hh:mm:ss,sssss
LCMM validation ending timestamp	Shows the LCMM validation ending timestamp. Displayed format is: YYYY-MM-DD hh:mm:ss,sssss

INX03 – Individual restriction detailed report – Output Screen (These columns will be shown for every instruction selected in the prompt screen)	
LCMM entry business date	Shows the LCMM entry business date. Displayed format is: YYYY-MM-DD
POOL party short name	Shows the short name of the party
POOL instruction counter	Shows the number of instructions that make up a pool as identified on the settlement restriction.
POOL settlement date	Shows the pool settlement date. Displayed format is: YYYY-MM-DD
POOL identification	Shows the reference identifying a pool as found on the settlement instruction. ⁷⁹

5.5.3.4 INX04 – Multi-criteria search of a set of settlement restrictions

Context of Usage

This report shows a list of details for selected finalised business settlement restrictions (SR), which it performs on two levels. In the first level, the report produces a list of SRs corresponding to user-supplied filter criteria. In the second level, the user may select one SR from the list and the detailed report provides a full list of attributes for the selected SR.

The attributes shown in the detailed report output provide business details related to the selected SR.

This report can be used by **NCB, PB, CSD, CSDP CB** and **ECSDCSD** users. **{CR-819}**

Report Access

This report can be reached in the following way:

- Content >>** Team Content >> **T2S >>** Predefined Reports >> **INX**
- T2S Instructions >> INX04**{CR-819}**

Screenshot

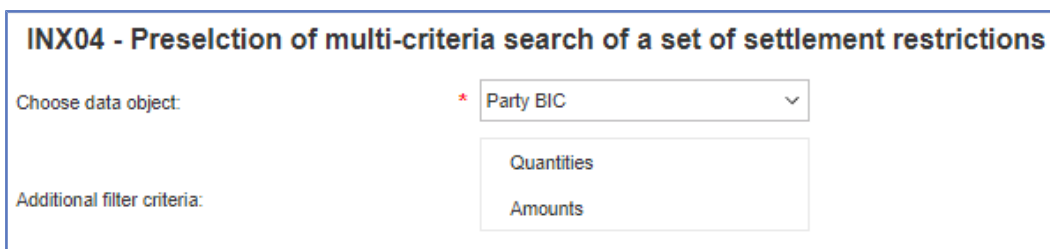

Illustration 330: **INX04 pre-selection screen {CR-819}**

79 This content is not applicable as of R6.2, and will become applicable upon the deployment of the Data Warehouse for T2S.

Field Description	INX04 – Multi-criteria search of a set of settlement restrictions – Pre-selection screen	
	Choose data object (one of both objects has to be chosen)	
	Party BIC	Provides fields for searching securities party BICs or cash party BICs in the next screen
	Account number	Provides fields for searching for securities account numbers or cash account numbers in the next screen
	Additional search criteria (both objects are optional)	
	Quantity of securities	Provides fields for searching different quantity ranges in the next screen
	Amounts	Provides fields for searching different amount ranges in the next screen

Screenshot

Illustration 331: INX04 prompt screen{CR-819}

Field Description

INX04 – Multi-criteria search of a set of settlement restrictions – Prompt Screen	
Securities party BIC	Filter to select which securities party BIC (CSDs, CSD participants or ECSDs) value/s should be included in the output.
Cash party BIC	Filter to select which cash party BIC (NCB or payment bank) value/s should be included in the output.

INX04 – Multi-criteria search of a set of settlement restrictions – Prompt Screen	
Securities account number	Filter to select which securities account number value/s should be included in the output.
T2S DCA number	Multiple selection text field to enter T2S DCA number that should be included in the output.
Settlement status	Filter to select which settlement status value/s should be included in the output. Possible values: <input type="checkbox"/> USET <input type="checkbox"/> PSET <input type="checkbox"/> SETT
Cancellation status	Filter to select which cancellation status value/s should be included in the output. Possible values: <input type="checkbox"/> NCAN <input type="checkbox"/> CANC
Entry date from	Filter to select the inclusive date from which entry date value/s should be included in the output. Must be used in conjunction with: <input type="checkbox"/> entry date to
Entry date to	Filter to select the inclusive date up to which entry date value/s should be included in the output. Must be used in conjunction with: <input type="checkbox"/> entry date from
Intended settlement date from	Filter to select the inclusive date from which intended settlement date value/s should be included in the output. Must be used in conjunction with: <input type="checkbox"/> intended settlement date to
Intended settlement date to	Filter to select the inclusive date up to which intended settlement date value/s should be included in the output.

INX04 – Multi-criteria search of a set of settlement restrictions – Prompt Screen	
	<p>Must be used in conjunction with:</p> <p><input type="checkbox"/> intended settlement date from</p>
<p>The following criteria are only shown in case that “Quantity of securities” was chosen as additional search criteria</p>	
<p>Original Instructed quantity from</p>	<p>Filter to select the inclusive quantity from which original instructed quantity value/s should be included in the output.</p> <p>Must be used in conjunction with:</p> <p><input type="checkbox"/> original instructed quantity to</p>
<p>Original Instructed quantity to</p>	<p>Filter to select the inclusive quantity up to which original instructed quantity value/s should be included in the output.</p> <p>Must be used in conjunction with:</p> <p><input type="checkbox"/> original instructed quantity from {CR-819}</p>
<p>Settled quantity from</p>	<p>Filter to select the inclusive quantity from which settled quantity value/s should be included in the output.</p> <p>Must be used in conjunction with:</p> <p><input type="checkbox"/> settled quantity to</p>
<p>Settled quantity to</p>	<p>Filter to select the inclusive quantity up to which settled quantity value/s should be included in the output.</p> <p>Must be used in conjunction with:</p> <p><input type="checkbox"/> settled quantity from</p>
<p>Cancelled quantity from</p>	<p>Filter to select the inclusive quantity from which cancelled quantity value/s should be included in the output.</p> <p>Must be used in conjunction with:</p> <p>cancelled quantity to</p>
<p>Cancelled quantity to</p>	<p>Filter to select the inclusive quantity up to which cancelled quantity value/s should be included in the output.</p>

INX04 – Multi-criteria search of a set of settlement restrictions – Prompt Screen	
	<p>Must be used in conjunction with:</p> <ul style="list-style-type: none"> <input type="checkbox"/> cancelled quantity from
<p>The following criteria are only shown in case that “Amounts” was chosen as additional search criteria</p>	
<p>Original Instructed amount from</p>	<p>Filter to select the inclusive amount from which original instructed amount value/s should be included in the output.</p> <p>Must be used in conjunction with:</p> <ul style="list-style-type: none"> <input type="checkbox"/> original instructed amount to
<p>Original Instructed amount to</p>	<p>Filter to select the inclusive amount up to which original instructed amount value/s should be included in the output.</p> <p>Must be used in conjunction with:</p> <ul style="list-style-type: none"> <input type="checkbox"/> original instructed amount from{CR-819}
<p>Settled amount from</p>	<p>Filter to select the inclusive amount from which settled amount value/s should be included in the output.</p> <p>Must be used in conjunction with:</p> <ul style="list-style-type: none"> <input type="checkbox"/> settled amount to
<p>Settled amount to</p>	<p>Filter to select the inclusive amount up to which settled amount value/s should be included in the output.</p> <p>Must be used in conjunction with:</p> <ul style="list-style-type: none"> <input type="checkbox"/> settled amount from
<p>Cancelled amount from</p>	<p>Filter to select the inclusive amount from which cancelled amount value/s should be included in the output.</p> <p>Must be used in conjunction with:</p> <ul style="list-style-type: none"> <input type="checkbox"/> cancelled amount to

INX04 – Multi-criteria search of a set of settlement restrictions – Prompt Screen

Cancelled amount to Filter to select the inclusive amount up to which cancelled amount value/s should be included in the output.

Must be used in conjunction with:

cancelled amount from

Screenshot

INX04 - Multi-criteria search of a set of settlement restrictions
Cash settlement restrictions

T2S actor instruction reference	Intended settlement date	Actual settlement date	Settlement status	Cancellation status	ISIN code	Original quantity	Settled quantity	Currency	Original amount	Settled amount	Transaction type code	CSD BIC	Account owner BIC	Securities account number	NCB BIC	Payment bank BIC	T2S dedicated cash account number
[link]	2023-09-19		USET	NCAN				EUR	10.00	0.00	SRCA				NCBKE20V00X	PMBAESQV00X	PMBAESQV00XDCAEURP1
[link]	2023-09-19		USET	NCAN				EUR	0.00	0.00	SRCA				NCBKE20V00X	PMBAESQV00X	PMBAESQV00XDCAEURP1
[link]	2023-09-19		USET	NCAN				EUR	50.00	0.00	SRCA				NCBBAHA00X	PBNBKHU00X	PBNBKHU00XDCAP41
[link]	2023-09-19		USET	NCAN				EUR	50.00	0.00	SRCA				NCBBAHA00X	PBNBKHU00X	PBNBKHU00XDCAP41
[link]	2023-09-19		USET	NCAN				EUR	7,200.00	0.00	SRCA				FAGPSP1000	FAGPSP1000	NIFRCSH31102EUR

INX04 - Multi-criteria search of a set of settlement restrictions
Securities settlement restrictions

T2S actor instruction reference	Intended settlement date	Actual settlement date	Settlement status	Cancellation status	ISIN code	Original quantity	Settled quantity	Currency	Original amount	Settled amount	Transaction type code	CSD BIC	Account owner BIC	Securities account number	NCB BIC	Payment bank BIC	T2S dedicated cash account number
[link]	2023-09-19		USET	CANC	HLBUE99A7111	1,500	0				SRSE	CSDAHLHE00X	FABSHHE00X	FABSHHE00XCCZDP137			
[link]	2023-09-19		USET	CANC	HLBUE99A7111	1,500	0				SRSE	CSDAHLHE00X	FABSHHE00X	FABSHHE00XCCZDP137			
[link]	2023-09-19		USET	CANC	HLBUE99A7111	1,500	0				SRSE	CSDAHLHE00X	FABSHHE00X	FABSHHE00XCCZDP137			

Illustration 332: INX04 list screen{CR-819}

Field Description

INX04 – Multi-criteria search of a set of settlement restrictions – List Screen

Number of settlement restrictions	Shows the number of settlement restrictions found matching the criteria
(For each restriction matching the selection criteria, one line will be displayed)	
T2S actor instruction reference	Shows the reference provided by the T2S actor The reference is built as a hyperlink which leads to the output details screen when clicked.
Intended settlement date	Shows the intended settlement date. Display format is: YYYY-MM-DD
Actual settlement date	Shows the actual settlement date.
Settlement status	Shows the settlement status Possible values: <input type="checkbox"/> USET (unsettled) <input type="checkbox"/> PSET (partially settled) <input type="checkbox"/> SETT (fully settled)
Cancellation status	Shows the cancellation status

INX04 – Multi-criteria search of a set of settlement restrictions – List Screen	
	Possible values: <input type="checkbox"/> NCAN (not cancelled) <input type="checkbox"/> CANC (cancelled)
ISIN code	Shows the ISIN
Original Instructed quantity	Shows the entered settlement quantity. {CR-819}
Settled quantity	Shows the settled settlement quantity.
Currency	Shows the currency code
Original Instructed amount	Shows the settlement amount. {CR-819}
Settled amount	Shows the settled settlement amount.
Transaction type code	Shows the transaction type of the settlement restriction. Possible values: <input type="checkbox"/> SRCA (settlement restriction on cash) <input type="checkbox"/> SRSE (settlement restriction on securities)
CSD BIC	Shows the BIC of the CSD
Account owner BIC	Shows the BIC of the securities account owner as per the SR.
Securities account number	Shows the impacted securities account number as per the SR.
NCB BIC	Shows the parent party BIC of the payment bank (if applicable)
Payment bank BIC	Shows the BIC of the payment bank (if applicable)
T2S dedicated cash account number	Shows the impacted T2S dedicated cash account number.

Screenshot

Reference information	
T2S actor instruction reference	
Status information	
Settlement status	SETT
Cancellation status	NCAN
Timeline information	
Entry date time	2023-09-12 14:51:34.870
Intended settlement date	2023-09-13
Actual settlement date	2023-09-13
Cancellation date	
Categorisation information	
Movement type	CASH
Restriction processing type from	DLVR
Restriction processing type to	COCB
Transaction type code	SRCA
Cash information	
Currency code	EUR
T2S dedicated cash account number	PMBAESQWXXXDCAEURP01
Original amount	10.00
Settled amount	10.00
Cancelled amount	
NCB BIC	NCBKESQWXXX
Payment bank BIC	PMBAESQWXXX
Process information	
Priority	
End of day restriction release	
LCMM information	
LCMM approval status	APPR

Illustration 333: INX04 details screen{CR-819}

Field Description

INX04 – Multi-criteria search of a set of settlement restrictions – Details Screen	
Reference information	
T2S actor instruction reference	Shows the reference provided by the T2S actor
Status information	
Settlement status	Shows the settlement status Possible values: <input type="checkbox"/> USET (unsettled) <input type="checkbox"/> PSET (partially settled) <input type="checkbox"/> SETT (fully settled)
Cancellation status	Shows the cancellation status Possible values: <input type="checkbox"/> NCAN (not cancelled) <input type="checkbox"/> CANC (cancelled)
Timeline information	
Entry date time	Shows the date when the settlement instruction entered the T2S system. Display format is: YYYY-MM-DD hh:mm:ss,sssss
Intended settlement date	Shows the intended settlement date. Display format is: YYYY-MM-DD
Actual settlement date	Shows the actual settlement date, if applicable. Display format is: YYYY-MM-DD

INX04 – Multi-criteria search of a set of settlement restrictions – Details Screen	
Cancellation date	Shows the date when the settlement instruction was cancelled, if applicable. Display format is: YYYY-MM-DD
Categorisation information	
Movement type	Shows the movement type of the settlement restriction. Possible values: <input type="checkbox"/> CASH (restriction on cash) <input type="checkbox"/> SCTY (restriction on securities)
Restriction processing type from	Shows the restriction processing type from which the cash/securities are debited/delivered. Possible values: <input type="checkbox"/> Rejection <input type="checkbox"/> CSD Validation Hold <input type="checkbox"/> Reservation <input type="checkbox"/> Blocking <input type="checkbox"/> Balance Type/Earmarking <input type="checkbox"/> Earmarking for Auto-collateralisation <input type="checkbox"/> Deliverable <input type="checkbox"/> Collateralised <input type="checkbox"/> CoSD Blocking
Restriction processing type to	Shows the restriction processing type to which the cash/securities are credited/received. Possible values: <input type="checkbox"/> Rejection <input type="checkbox"/> CSD Validation Hold <input type="checkbox"/> Reservation <input type="checkbox"/> Blocking <input type="checkbox"/> Balance Type/Earmarking <input type="checkbox"/> Earmarking for Auto-collateralisation <input type="checkbox"/> Deliverable <input type="checkbox"/> Collateralised <input type="checkbox"/> CoSD blocking

INX04 – Multi-criteria search of a set of settlement restrictions – Details Screen	
Transaction type code	Shows the transaction type of the settlement restriction. Possible values: <input type="checkbox"/> SRCA (settlement restriction on cash) <input type="checkbox"/> SRSE (settlement restriction on securities)
Securities information (Please note, that this part will only be filled for restrictions on securities)	
ISIN code	Shows the ISIN.
Securities account number	Shows the impacted securities account number as per the SI,
Settlement type	Shows the settlement type. Possible values: <input type="checkbox"/> NOMI (nominal) <input type="checkbox"/> UNIT (units)
Original Instructed quantity	Shows the original instructed settlement quantity. {CR-819}
Settled quantity	Shows the settled settlement quantity.
Cancelled quantity	Shows the unsettled quantity if the SI is not completely settled.
Securities party information	
CSD BIC	Shows the BIC of the CSD
CSD participant BIC	Shows the BIC of the CSD participant.
External CSD BIC	Shows the BIC of the external CSD (ECSD)
Cash information (Please note, that this part will only be filled for restrictions on cash)	
Currency code	Shows the currency code.
T2S dedicated cash account number	Shows the impacted T2S dedicated cash account number.
Original Instructed amount	Shows the original instructed settlement amount. {CR-819}
Settled amount	Shows the settled settlement amount.
Cancelled amount	Shows the cancelled amount if the SR did not reach full settlement.

INX04 – Multi-criteria search of a set of settlement restrictions – Details Screen	
NCB BIC	Shows the parent party BIC of the payment bank (if applicable)
Payment bank BIC	Shows the BIC of the payment bank
Process information	
CoSD blocking	Shows whether the restriction relates to a CoSD blocking. Possible values: <input type="checkbox"/> False <input type="checkbox"/> True
Priority	Shows the priority. Possible values: <input type="checkbox"/> 0001 (reserved) <input type="checkbox"/> 0002 (top) <input type="checkbox"/> 0003 (high) <input type="checkbox"/> 0004 (normal)
End of day restriction release	Shows whether the restriction relates to an end of day restriction release. Possible values: <input type="checkbox"/> False <input type="checkbox"/> True
LCMM information	
LCMM approval status	Shows the LCMM approval status. Possible values: <input type="checkbox"/> APPR (approved (default value)) <input type="checkbox"/> AWAP (awaiting approval) <input type="checkbox"/> REJT (rejected) <input type="checkbox"/> RVKD (revoked) ⁸⁰

80 This content is not applicable as of R6.2, and will become applicable upon the deployment of the Data Warehouse for T2S.

5.5.3.5 INX05 – Liquidity transfers

Context of Usage

This report shows the cash activity for all finalised liquidity transfers (LT) at CB, PB or T2S dedicated cash account level, during a selected period of time. The volume of finalised liquidity transfers per transaction category / transaction sub-category / underlying transfer type, together with the aggregated instructed and actual settled values, are shown.

This report can be used by CB **and PB** users. **{CR-819}**

Report Access

This report can be reached in the following way:

- [Content >>](#) Team Content >> [T2S >>](#) Predefined Reports >> [INX](#)
 - T2S Instructions >> INX05 **{CR-819}**

Screenshot

Illustration 334: INX05 prompt screen {CR-819}

Field
Description

INX05 – Liquidity transfers – Prompt Screen	
Date From	You can select the date by clicking on the calendar. This field is mandatory.
Date To	You can select the end date of the period, for which the report should contain the data by clicking on the calendar. For valid report results, the current day cannot be selected. This field is mandatory.

INX05 – Liquidity transfers – Prompt Screen	
Currency	<p>You can use this drop-down field to select the currency.</p> <p>This field is mandatory.</p>
Party BIC	<p>You can use this drop-down field to select one or several party BIC. This field will show all related BICs, which belong to the default data scope of the user's party.</p> <p>This field is optional.</p>
T2S DCA number	<p>You can use this drop-down field to select one or several T2S DCA numbers. This field will show all related T2S DCAs, which belong to default data scope of the user's party and which belong to the parties selected in field "Party BIC". If no Party BICs are selected, this field shows all T2S DCA numbers belonging to the default data scope of the user's party.</p> <p>This field is optional.</p>

Screenshot

t2s TARGET SERVICES		INX05 – Liquidity transfers									
Filters Date from : 2023-09-01 Date to : 2023-09-18 Currency : EUR											
Liquidity transfers											
Liquidity Transfer Type: Inbound liquidity transfer											
Transaction category	Transaction sub-category	Underlying transfer type	Volume of liquidity transfer					Value of transfers	Value actually transferred		
			Totally settled	Partially settled	Totally cancelled	Rejected	Revoked				
LQTR	LQTR	Immediate	19	0	0	0	0	1,075,410.00	1,075,410.00		
		Standing	49	0	0	0	0	630,232.29	630,232.29		
		Immediate	2,914	0	0	0	0	2,059,041,059.48	2,059,041,059.48		
		Predefined	1	0	0	0	0	16,156.00	16,156.00		
		Standing	2,086	0	23	0	0	30,747,684.08	29,686,002.41		
Total			5,049	0	23	0	2,092,410,742.75	2,091,346,861.08			
Liquidity Transfer Type: Outbound liquidity transfer											
Transaction category	Transaction sub-category	Underlying transfer type	Volume of liquidity transfer					Value of transfers	Value actually transferred		
			Totally settled	Partially settled	Totally cancelled	Rejected	Revoked				
LQTR	LQTR	Immediate	3	0	0	0	0	49,808.68	49,808.68		
		Standing	49	0	34	0	0	382,000.84	630,232.29		
		Immediate	285	5	11	0	0	279,027,448.32	278,472,083.32		
		Predefined	1	0	0	0	0	16,156.00	16,156.00		
		Standing	2,149	7	578	0	0	19,248,797.69	15,426,180.79		
TCAT	LTAC	Standing	130	0	1,254	0	0	0.00	16,888,888.03		
		CARL	Standing	23	0	0	0	0	0.00	677,066.00	
			MPQR	Standing	22	0	0	0	0	0.00	26,640.04
Total			2,642	12	1,875	0	0	298,734,009.53	311,886,840.15		
Liquidity Transfer Type: Internal liquidity transfer											
Transaction category	Transaction sub-category	Underlying transfer type	Volume of liquidity transfer					Value of transfers	Value actually transferred		
			Totally settled	Partially settled	Totally cancelled	Rejected	Revoked				
LQTR	LQTR	Immediate	12	0	0	0	0	976,796.36	976,796.36		
		Standing	3	0	0	0	0	0.00	220.00		
		Immediate	1,616	7	111	0	0	799,652,697.46	448,029,257.08		
TCAT	ALOP	Standing	144	0	0	0	0	0.00	11,625.00		
Total			1,775	7	111	0	0	800,629,693.82	449,017,896.42		
Total											
Transaction category	Transaction sub-category	Underlying transfer type	Volume of liquidity transfer					Value of transfers	Value actually transferred		
			Totally settled	Partially settled	Totally cancelled	Rejected	Revoked				
LQTR	LQTR	Immediate	34	0	0	0	0	3,001,813.94	3,001,813.94		
		Standing	101	0	34	0	0	1,022,233.13	1,260,084.68		
		Immediate	4,796	12	122	0	0	3,137,721,406.26	2,785,642,399.88		
		Predefined	2	0	0	0	0	32,312.00	32,312.00		
		Standing	4,215	7	599	0	0	49,966,681.77	48,112,183.20		
TCAT	LTAC	Standing	130	0	1,254	0	0	0.00	16,888,888.03		
		ALOP	Standing	144	0	0	0	0	0.00	11,625.00	
			CARL	Standing	23	0	0	0	0	0.00	677,066.00
			MPQR	Standing	22	0	0	0	0	0.00	26,640.04
Total			9,466	19	2,009	0	0	3,191,774,446.10	2,852,253,399.63		

Illustration 335: INX05 output screen{CR-819}

Field Description	INX05 – Liquidity transfers – Output Screen	
	Inbound liquidity transfers	
Transaction category	Shows the transaction category of the liquidity transfer. Possible values are: <input type="checkbox"/> LQTR <input type="checkbox"/> TCAT	
Transaction sub-category	Shows the transaction sub-category of the liquidity transfer. Possible values are: <input type="checkbox"/> EDLT <input type="checkbox"/> LQTR <input type="checkbox"/> LTAC <input type="checkbox"/> ALOP <input type="checkbox"/> CARL <input type="checkbox"/> MPOR	
Underlying transfer type	Shows the underlying transfer type of the liquidity transfer. Possible values are: <input type="checkbox"/> Standing <input type="checkbox"/> Predefined <input type="checkbox"/> Immediate	
Totally settled	A count of all finalised inbound LTs which have been totally settled, per transaction category / transaction sub-category / underlying transaction type.	
Partially settled	A count of all finalised inbound LTs which have been only partially settled, per transaction category / transaction sub-category / underlying transaction type.	
Totally cancelled	A count of all finalised inbound LTs which have been totally cancelled (ie. no settlement at all), per transaction category / transaction sub-category / underlying transaction type.	
Rejected	A count of all finalised inbound LTs which were rejected before settlement, per transaction category / transaction sub-category / underlying transaction type.	
Revoked	A count of all finalised inbound LTs which were revoked after settlement, per transaction category / transaction sub-category / underlying transaction type.	

INX05 – Liquidity transfers – Output Screen	
Value of transfers	Sum of the original instructed transfer amounts of all finalised inbound LTs, per transaction category / transaction sub-category / underlying transaction type.
Value actually transferred	Sum of the actual settled amounts of all finalised inbound LTs, per transaction category / transaction sub-category / underlying transaction type.
Outbound liquidity transfers	
Transaction category	Shows the transaction category of the liquidity transfer. Possible values are: <input type="checkbox"/> LQTR <input type="checkbox"/> TCAT <input type="checkbox"/> STND
Transaction sub-category	Shows the transaction sub-category of the liquidity transfer. Possible values are: <input type="checkbox"/> EDLT <input type="checkbox"/> LQTR <input type="checkbox"/> LTAC <input type="checkbox"/> ALOP <input type="checkbox"/> CARL <input type="checkbox"/> MPOR <input type="checkbox"/> STND
Underlying transfer type	Shows the underlying transfer type of the liquidity transfer. Possible values are: <input type="checkbox"/> Standing <input type="checkbox"/> Predefined <input type="checkbox"/> Immediate
Totally settled	A count of all finalised inbound LTs which have been totally settled, per transaction category / transaction sub-category / underlying transaction type.
Partially settled	A count of all finalised inbound LTs which have been only partially settled, per transaction category / transaction sub-category / underlying transaction type.

INX05 – Liquidity transfers – Output Screen	
Totally cancelled	A count of all finalised inbound LTs which have been totally cancelled (ie. no settlement at all), per transaction category / transaction sub-category / underlying transaction type.
Rejected	A count of all finalised inbound LTs which were rejected before settlement, per transaction category / transaction sub-category / underlying transaction type.
Revoked	A count of all finalised inbound LTs which were revoked after settlement, per transaction category / transaction sub-category / underlying transaction type.
Value of transfers	Sum of the original instructed transfer amounts of all finalised inbound LTs, per transaction category / transaction sub-category / underlying transaction type.
Value actually transferred	Sum of the actual settled amounts of all finalised inbound LTs, per transaction category / transaction sub-category / underlying transaction type.
Internal liquidity transfers	
Transaction category	Shows the transaction category of the liquidity transfer. Possible values are: <input type="checkbox"/> LQTR <input type="checkbox"/> TCAT
Transaction sub-category	Shows the transaction sub-category of the liquidity transfer. Possible values are: <input type="checkbox"/> EDLT <input type="checkbox"/> LQTR <input type="checkbox"/> LTAC <input type="checkbox"/> ALOP <input type="checkbox"/> CARL <input type="checkbox"/> MPOR
Underlying transfer type	Shows the underlying transfer type of the liquidity transfer. Possible values are: <input type="checkbox"/> Standing <input type="checkbox"/> Predefined <input type="checkbox"/> Immediate

INX05 – Liquidity transfers – Output Screen	
Totally settled	A count of all finalised inbound LTs which have been totally settled, per transaction category / transaction sub-category / underlying transaction type.
Partially settled	A count of all finalised inbound LTs which have been only partially settled, per transaction category / transaction sub-category / underlying transaction type.
Totally cancelled	A count of all finalised inbound LTs which have been totally cancelled (ie. no settlement at all), per transaction category / transaction sub-category / underlying transaction type.
Rejected	A count of all finalised inbound LTs which were rejected before settlement, per transaction category / transaction sub-category / underlying transaction type.
Revoked	A count of all finalised inbound LTs which were revoked after settlement, per transaction category / transaction sub-category / underlying transaction type.
Value of transfers	Sum of the original instructed transfer amounts of all finalised inbound LTs, per transaction category / transaction sub-category / underlying transaction type.
Value actually transferred	Sum of the actual settled amounts of all finalised inbound LTs, per transaction category / transaction sub-category / underlying transaction type.
Total	
Transaction category	Shows the transaction category of the liquidity transfer. Possible values are: <input type="checkbox"/> LQTR <input type="checkbox"/> TCAT <input type="checkbox"/> STND
Transaction sub-category	Shows the transaction sub-category of the liquidity transfer. Possible values are: <input type="checkbox"/> EDLT <input type="checkbox"/> LQTR <input type="checkbox"/> LTAC <input type="checkbox"/> ALOP <input type="checkbox"/> CARL

INX05 – Liquidity transfers – Output Screen	
	<input type="checkbox"/> MPOR <input type="checkbox"/> STND
Underlying transfer type	Shows the underlying transfer type of the liquidity transfer. Possible values are: <input type="checkbox"/> Standing <input type="checkbox"/> Predefined <input type="checkbox"/> Immediate
Totally settled	Sum of all totally settled measures across all transfer types, per transaction category / transaction sub-category / underlying transaction type.
Partially settled	Sum of all partially settled measures across all transfer types, per transaction category / transaction sub-category / underlying transaction type.
Totally cancelled	Sum of all totally cancelled measures across all transfer types, per transaction category / transaction sub-category / underlying transaction type.
Rejected	Sum of all rejected measures across all transfer types, per transaction category / transaction sub-category / underlying transaction type.
Revoked	Sum of all revoked measures across all transfer types, per transaction category / transaction sub-category / underlying transaction type.
Value of transfers	Sum of all value of transfers measures across all transfer types, per transaction category / transaction sub-category / underlying transaction type.
Value actually transferred	Sum of all value actually transferred measures across all transfer types, per transaction category / transaction sub-category / underlying transaction type. ⁸¹

81 This content is not applicable as of R6.2, and will become applicable upon the deployment of the Data Warehouse for T2S.

5.5.3.6 INX06 – Multi-criteria search of a set of business cancellations

Context of Usage

This report shows a list of details for selected business cancellation instructions (CI), which it performs on two levels. In the first level, the report produces a list of CIs corresponding to user-supplied filter criteria. In the second level, the user may select one CI from the list and the detailed report provides a full list of attributes for the selected CI.

The attributes shown in the detailed report output provide business details related to the selected CI.

This report can be used by **NCB, PB, CSD, CSDP and ECSD CB and CSD** users. **{CR-819}**

Report Access

This report can be reached in the following way:

- Content >>** Team Content >> **T2S >>** Predefined Reports >> **INX**
- T2S Instructions >> INX06 **{CR-819}**

Screenshot



Illustration 336: **INX06 pre-selection screen** {CR-819}

Field Description

INX06 – Multi-criteria search of a set of business cancellations – Pre-selection screen	
Choose data object	
(one of both objects has to be chosen)	
Party BIC	Provides fields for searching securities party BICs or cash party BICs in the next screen
Account number	Provides fields for searching for securities account numbers or cash account numbers in the next screen
Additional search criteria	
(both objects are optional)	
Quantity of securities	Provides fields for searching different quantity ranges in the next screen
Amounts	Provides fields for searching different amount ranges in the next screen

Screenshot

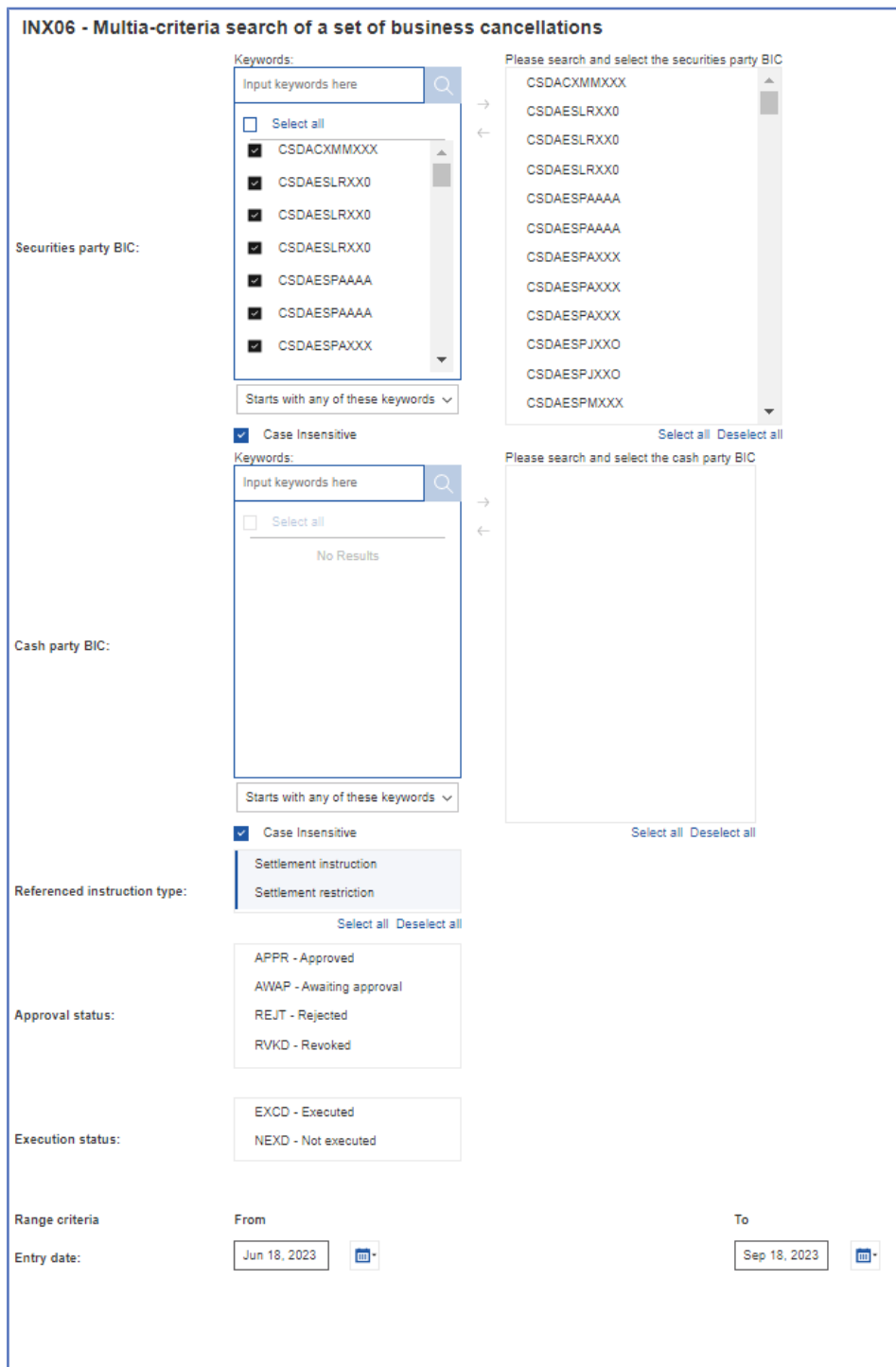

Illustration 337: INX06 prompt screen{CR-819}

Field Description

INX06 – Multi-criteria search of a set of business cancellations – Prompt Screen	
Securities party BIC	Filter to select which securities party BIC (CSDs, CSD participants or ECSDs) value/s should be included in the output.

INX06 – Multi-criteria search of a set of business cancellations – Prompt Screen	
Cash party BIC	Filter to select which cash party BIC (NCB or payment bank) value/s should be included in the output.
Securities account number	Filter to select which securities account number value/s should be included in the output.
T2S DCA number	Multiple selection text field to enter T2S DCA number value/s that should be included in the output.
Referenced instruction type	Filter to select which referenced instruction types should be included in the output. Possible values: <input type="checkbox"/> STIN (Settlement instruction) <input type="checkbox"/> STRN (Settlement restriction)
Approval status	Filter to select which approval status value/s should be included in the output. Possible values: <input type="checkbox"/> APPR (Approved) <input type="checkbox"/> AWAP (Awaiting approval) <input type="checkbox"/> REJT (Rejected) <input type="checkbox"/> RVKD (Revoked)
Execution status	Filter to select which execution status value/s should be included in the output. Possible values: <input type="checkbox"/> EXCD (Executed) <input type="checkbox"/> NEXD (Not executed)
Entry date from	Filter to select the inclusive date from which entry date value/s should be included in the output. Must be used in conjunction with: <input type="checkbox"/> entry date to
Entry date to	Filter to select the inclusive date up to which entry date value/s should be included in the output. Must be used in conjunction with: <input type="checkbox"/> entry date from

INX06 – Multi-criteria search of a set of business cancellations – Prompt Screen	
The following criteria are only shown in case that “Quantity of securities” was chosen as additional search criteria	
Original Instructed settlement quantity from	Filter to select the inclusive quantity from which original instructed settlement quantity value/s should be included in the output. Must be used in conjunction with: <input type="checkbox"/> original instructed settlement quantity to
Original Instructed settlement quantity to	Filter to select the inclusive quantity up to which original instructed settlement quantity value/s should be included in the output. Must be used in conjunction with: <input type="checkbox"/> original instructed settlement quantity from{CR-819}
The following criteria are only shown in case that “Amounts” was chosen as additional search criteria	
Original Instructed settlement amount from	Filter to select the inclusive amount from which original instructed settlement amount value/s should be included in the output. Must be used in conjunction with: <input type="checkbox"/> original instructed settlement amount to
Original Instructed settlement amount to	Filter to select the inclusive amount up to which original instructed settlement amount value/s should be included in the output. Must be used in conjunction with: <input type="checkbox"/> original instructed settlement amount from{CR-819}

Screenshot

Underlying T2S instruction reference	Entry date time	LCMM approval status	Execution status	Original settlement quantity	Original settlement amount	Referenced instruction type	CSB BIC	CSB participant BIC	Securities account number	NCB BIC	Payment bank BIC	T2S OCA number
11193712009	2023-06-20 10:17:30.954	APPR	EXCD	1	0.00	STN	CSDAHUM00XXX	PARAHUM00XXX	PUBAHUM0000CEPR130			
111937186009	2023-06-30 11:12:43.576	APPR	EXCD	1	0.00	STN	CSDAHUM00XXX	PARAHUM00XXX	PUBAHUM0000CEPR130			
1119324462009	2023-07-07 17:39:38.112	APPR	EXCD	1	0.00	STN	CSDAHUM00XXX	PARAHUM00XXX	PUBAHUM0000CEPR130			
1119327110009	2023-07-10 09:28:43.844	APPR	EXCD	1	0.00	STN	CSDAHUM00XXX	PARAHUM00XXX	PUBAHUM0000CEPR130			
111931054001	2023-07-11 15:40:23.253	APPR	EXCD	1	0.00	STN	CSDAHUM00XXX	PARAHUM00XXX	PUBAHUM0000CEPR130			
1119318933009	2023-07-12 13:24:39.700	APPR	EXCD	1	0.00	STN	CSDAHUM00XXX	PARAHUM00XXX	PUBAHUM0000CEPR130			
1119329310009	2023-07-12 17:23:51.844	APPR	EXCD	1	0.00	STN	CSDAHUM00XXX	PARAHUM00XXX	PUBAHUM0000CEPR130			
1119329331009	2023-07-12 18:44:03.762	APPR	EXCD	1	0.00	STN	CSDAHUM00XXX	PARAHUM00XXX	PUBAHUM0000CEPR130			
111932628009	2023-07-14 09:28:35.918	APPR	EXCD	1	0.00	STN	CSDAHUM00XXX	PARAHUM00XXX	PUBAHUM0000CEPR130			
1119326301009	2023-07-21 11:09:16.712	APPR	EXCD	1	0.00	STN	CSDAHUM00XXX	PARAHUM00XXX	PUBAHUM0000CEPR130			
111931374009	2023-07-27 13:27:32.460	APPR	EXCD	1	0.00	STN	CSDAHUM00XXX	PARAHUM00XXX	PUBAHUM0000CEPR130			
1119316956009	2023-07-31 09:28:14.937	APPR	EXCD	1	0.00	STN	CSDAHUM00XXX	PARAHUM00XXX	PUBAHUM0000CEPR130			
1119304100009	2023-08-07 10:09:23.965	APPR	EXCD	1	0.00	STN	CSDAHUM00XXX	PARAHUM00XXX	PUBAHUM0000CEPR130			
111939720009	2023-08-07 12:26:39.507	APPR	EXCD	1	0.00	STN	CSDAHUM00XXX	PARAHUM00XXX	PUBAHUM0000CEPR130			
1119174272009	2023-08-11 19:42:04.136	APPR	EXCD	1	0.00	STN	CSDAHUM00XXX	PARAHUM00XXX	PUBAHUM0000CEPR130			
1119304601009	2023-08-18 09:27:25.480	APPR	EXCD	1	0.00	STN	CSDAHUM00XXX	PARAHUM00XXX	PUBAHUM0000CEPR130			
1120010584009	2023-08-25 10:31:35.734	APPR	EXCD	1	0.00	STN	CSDAHUM00XXX	PARAHUM00XXX	PUBAHUM0000CEPR130			
1120009240009	2023-08-28 17:22:53.911	APPR	EXCD	1	0.00	STN	CSDAHUM00XXX	PARAHUM00XXX	PUBAHUM0000CEPR130			
1121111600009	2023-09-11 11:19:16.528	APPR	EXCD	1	0.00	STN	CSDAHUM00XXX	PARAHUM00XXX	PUBAHUM0000CEPR130			
112036210009	2023-09-13 12:42:55.737	APPR	EXCD	1	0.00	STN	CSDAHUM00XXX	PARAHUM00XXX	PUBAHUM0000CEPR130			

Illustration 338: INX06 list screen{CR-819}

Field Description

INX06 – Multi-criteria search of a set of business cancellations – List Screen	
Number of cancellations instructions	Shows the number of cancellation instructions found matching the criteria (For each cancellation matching the selection criteria, one line will be displayed)
Underlying T2S instruction reference	Shows the T2S reference of the settlement instruction or settlement restriction.
Entry date time	Shows the date and time the cancellation instruction entered T2S. Displayed format is: YYYY-MM-DD hh:mm:ss,sssss
Intended settlement date	Shows the intended settlement date of the underlying instruction. Displayed format is: YYYY-MM-DD{CR-819}
LCMM approval status	Shows the LCMM approval status. Possible values: <input type="checkbox"/> APPR (approved (default value)) <input type="checkbox"/> AWAP (awaiting approval) <input type="checkbox"/> REJT (rejected) <input type="checkbox"/> RVKD (revoked)
Execution status	Shows the execution status of the cancellation instruction. Possible values: <input type="checkbox"/> EXCD (executed) <input type="checkbox"/> NEXD (not executed)
Original Instructed settlement quantity	Shows the original instructed quantity of the securities of the underlying instruction in units or face amount.

INX06 – Multi-criteria search of a set of business cancellations – List Screen	
Original Instructed settlement amount	Shows the original instructed amount of the underlying instruction in the instruction’s currency. {CR-819}
Referenced instruction type	Shows the type of the referenced instruction: Possible values: <input type="checkbox"/> STIN (settlement instruction) <input type="checkbox"/> STRN (settlement restriction)
CSD Id	Shows the BIC of the CSD
CSD participant Id	Shows the BIC of the CSD participant
Securities account number	Shows the securities account number of the underlying instruction.
NCB BIC	Shows the parent party BIC of the payment bank (if applicable)
Payment bank BIC	Shows the BIC of the payment bank (if applicable)
T2S dedicated cash account number	Shows the T2S dedicated cash account number of the underlying instruction.
Securities account number	Shows the impacted securities account number as per the SR.
NCB BIC	Shows the parent party BIC of the payment bank (if applicable)
Payment bank BIC	Shows the BIC of the payment bank (if applicable)

Screenshot

INX06 - Multia-criteria search of a set of business cancellations

Multi-criteria search of a set of business cancellations - details:

Reference information	
Underlying T2S instruction reference	ACLINK091-35636
Status information	
Execution status	EXCD
Match status	MACH
Cancellation status	NDEN
Timeline information	
Entry date time	2023-06-01 14:55:59.776
Execution date	2023-06-01
Categorisation information	
Cancellation instruction type	PTYC
Referenced instruction type	STIN
Securities information	
ISIN	
Securities account number	PARAESQAXXXSDPP0001
Securities settlement type code	UNIT
Original settlement quantity	0
CSD BIC	CSDYESQAXXX
CSD participant BIC	PARAESQAXXX
External CSD BIC	
Cash information	
Currency code	EUR
T2S dedicated cash account number	
Original settlement amount	0.00
NCB BIC	
Payment bank BIC	
Process information	
Reason code reference	n/a
Externally matched	T
LCMM information	
LCMM approval status	APPR

Illustration 339: INX06 details screen{CR-819}

Field Description	INX06 – Multi-criteria search of a set of business cancellations – Details Screen	
Reference information		
Underlying T2S instruction reference	Shows the T2S reference of the settlement instruction or the settlement restriction.	
Status information		
Execution status	Shows the execution status of the cancellation instruction. Possible values: <input type="checkbox"/> EXCD (executed) <input type="checkbox"/> NEXD (not executed)	
Match status	Shows the matching status of the cancellation instruction. Possible values: <input type="checkbox"/> MACH (matched) <input type="checkbox"/> NMAT (unmatched)	
Cancellation status	Shows the cancellation status of the cancellation instruction. Possible values: <input type="checkbox"/> DEND (denied) <input type="checkbox"/> NDEN (not denied)	
Timeline information		
Entry date time	Shows the date and time the cancellation instruction entered T2S. Displayed format is: YYYY-MM-DD hh:mm:ss, sssss{CR-819}	
Execution date	Shows the execution date of the cancellation instruction. Displayed format is: YYYY-MM-DD	
Categorisation information		
Cancellation instruction type	Shows the type of cancellation. Possible values: <input type="checkbox"/> PTYC (party cancellation) <input type="checkbox"/> CSDC (CSD cancellation) <input type="checkbox"/> COSD (CoSD cancellation)	
Referenced instruction type	Shows the type of the referenced instruction: Possible values:	

INX06 – Multi-criteria search of a set of business cancellations – Details Screen	
	<input type="checkbox"/> STIN (settlement instruction) <input type="checkbox"/> STRN (settlement restriction)
Securities information	
(Please note, that this part will not be filled for cancellations for settlement restrictions on cash)	
ISIN code	Shows the ISIN.
Securities account number	Shows the securities account number of the underlying instruction.
Securities settlement type	Shows the settlement type. Possible values: <input type="checkbox"/> NOMI (nominal) <input type="checkbox"/> UNIT (units)
Original Instructed settlement quantity	Shows the original instructed quantity of the securities of the underlying instruction in units or face amount. {CR-819}
CSD BIC	Shows the BIC of the CSD
CSD participant BIC	Shows the BIC of the CSD participant
External CSD BIC	Shows the BIC of the external CSD
Cash information	
(Please note, that this part will not be filled for cancellations for restrictions on securities or for cancellations for settlement instructions “FOP”)	
Currency code	Shows the currency code.
T2S dedicated cash account number	Shows the T2S dedicated cash account number of the underlying instruction.
Original Instructed settlement amount	Shows the original instructed amount of the underlying instruction in the instruction’s currency. {CR-819}
NCB BIC	Shows the BIC of the NCB
Payment bank BIC	Shows the BIC of the payment bank
Process information	
Reason code reference	Shows the reason code reference of the cancellation instruction.
Externally matched	Shows if the instruction is already matched or not when it enters T2S.

INX06 – Multi-criteria search of a set of business cancellations – Details Screen	
	Possible values: <input type="checkbox"/> Yes True (already matched outside T2S) <input type="checkbox"/> No False (unmatched){CR-819}
LCMM information	
LCMM approval status	Shows the LCMM approval status. Possible values: <input type="checkbox"/> APPR (approved (default value)) <input type="checkbox"/> AWAP (awaiting approval) <input type="checkbox"/> REJT (rejected) <input type="checkbox"/> RVKD (revoked) ⁸²

5.5.3.7 INX07 – Multi-criteria search of a set of amendment instructions

Context of Usage

This report shows a list of details for selected amendment instructions (AI), which it performs on two levels. In the first level, the report produces a list of AIs corresponding to user-supplied filter criteria. In the second level, the user may select one AI from the list and the detailed report provides a full list of attributes for the selected AI

The attributes shown in the detailed report output provide business details related to the selected AI.

This report can be used by **NCB, PB, CSD, CSDP and ECSD CB and CSD** users.{CR-819}

Report Access

This report can be reached in the following way:

- Content >>** Team Content >> **T2S >>** Predefined Reports >> **INX**
 :- T2S Instructions >> INX07{CR-819}

82 This content is not applicable as of R6.2, and will become applicable upon the deployment of the Data Warehouse for T2S.

Screenshot



Illustration 340: **INX07 pre-selection screen** {CR-819}

Field Description

INX07 – Multi-criteria search of a set of amendment instructions – Pre-selection screen	
Choose data object	
(one of both objects has to be chosen)	
Party BIC	Provides fields for searching securities party BICs or cash party BICs in the next screen
Account number	Provides fields for searching for securities account numbers or cash account numbers in the next screen
Additional search criteria	
(both objects are optional)	
Quantities	Provides fields for searching different quantity ranges in the next screen
Amounts	Provides fields for searching different amount ranges in the next screen

Screenshot

INX07 – Prompt

Securities party BIC:

Keywords:

→
↩

Select all

- CSDACXMMXXX
- CSDAESLRXX0
- CSDAESLRXX0
- CSDAESLRXX0
- CSDAESLRXX0
- CSDAESPAAAA
- CSDAESPAXXX

Starts with any of these keywords ▾

Case Inensitive

Cash party BIC:

Keywords:

→
↩

No Results

Starts with any of these keywords ▾

Case Inensitive

Please search and select the securities party BIC

- CSDACXMMXXX
- CSDAESLRXX0
- CSDAESLRXX0
- CSDAESLRXX0
- CSDAESPAAAA
- CSDAESPAAAA
- CSDAESPAXXX
- CSDAESPAXXX
- CSDAESPAXXX
- CSDAESPJXX0
- CSDAESPJXX0
- CSDAESPMXXX

Select all Deselect all

Please search and select the cash party BIC

No Results

Select all Deselect all

Referenced instruction type:

STIN

STRN

Select all Deselect all



Partial settlement indicator:	NPAR PART PARC PARQ Select all Deselect all
Priority:	0001 0003 0004 Select all Deselect all
Approval status:	APPR AWAP REJT RVKD Select all Deselect all
Execution status:	EXCD NEXD Select all Deselect all
Range criteria	From <input type="text"/> To <input type="text"/>
Entry date:	<input type="text" value="Jun 1, 2023"/>  <input type="text" value="Sep 18, 2023"/> 

Illustration 341: INX07 prompt screen{CR-819}

Field Description

INX07 – Multi-criteria search of a set of amendment instructions – Prompt Screen	
Securities party BIC	Filter to select which securities party BIC (CSDs, CSD participants or ECSDs) value/s should be included in the output.
Cash party BIC	Filter to select which cash party BIC (NCB or payment bank) value/s should be included in the output.
Securities account number	Filter to select which securities account number value/s should be included in the output.
T2S DCA number	Multiple selection text field to enter T2S DCA number value/s that should be included in the output.
Referenced instruction type	Filter to select which referenced instruction types should be included in the output. Possible values:

INX07 – Multi-criteria search of a set of amendment instructions – Prompt Screen	
	<input type="checkbox"/> STIN (Settlement instruction) <input type="checkbox"/> STRN (Settlement restriction)
Partial settlement indicator	Filter to select which partial settlement indicator value/s should be included in the output. Possible values: <input type="checkbox"/> NPAR <input type="checkbox"/> PART <input type="checkbox"/> PARC <input type="checkbox"/> PARQ
Priority	Filter to select which priority value/s should be included in the output. Possible values: <input type="checkbox"/> 0001 <input type="checkbox"/> 0003 <input type="checkbox"/> 0004
Approval status	Filter to select which approval status value/s should be included in the output. Possible values: <input type="checkbox"/> APPR <input type="checkbox"/> AWAP <input type="checkbox"/> REJT <input type="checkbox"/> RVKD
Execution status	Filter to select which execution status value/s should be included in the output. Possible values: <input type="checkbox"/> EXCD <input type="checkbox"/> NEXD
Entry date time from	Filter to select the inclusive date from which entry date value/s should be included in the output. Must be used in conjunction with: <input type="checkbox"/> entry date time to

INX07 – Multi-criteria search of a set of amendment instructions – Prompt Screen	
Entry date time to	<p>Filter to select the inclusive date up to which entry date value/s should be included in the output.</p> <p>Must be used in conjunction with:</p> <p><input type="checkbox"/> entry date time from</p>
<p>The following criteria are only shown in case that “Quantity of securities” was chosen as additional search criteria</p>	
Original Instructed settlement quantity from	<p>Filter to select the inclusive quantity from which original instructed settlement quantity value/s should be included in the output.</p> <p>Must be used in conjunction with:</p> <p><input type="checkbox"/> original instructed settlement quantity to</p>
Original Instructed settlement quantity to	<p>Filter to select the inclusive quantity up to which original instructed settlement quantity value/s should be included in the output.</p> <p>Must be used in conjunction with:</p> <p><input type="checkbox"/> original instructed settlement quantity from{CR-819}</p>
<p>The following criteria are only shown in case that “Amounts” was chosen as additional search criteria</p>	
Original Instructed settlement amount from	<p>Filter to select the inclusive amount from which original instructed settlement amount value/s should be included in the output.</p> <p>Must be used in conjunction with:</p> <p><input type="checkbox"/> original instructed settlement amount to</p>
Original Instructed settlement amount to	<p>Filter to select the inclusive amount up to which original instructed settlement amount value/s should be included in the output.</p> <p>Must be used in conjunction with:</p> <p><input type="checkbox"/> original instructed settlement amount from{CR-819}</p>

Screenshot

Illustration 342: INX07 list screen{CR-819}

Field Description

INX07 – Multi-criteria search of a set of amendment instructions – List Screen	
Number of amendment instructions	Shows the number of amendment instructions found matching the criteria
(For each amendment instruction matching the selection criteria, one line will be displayed)	
Underlying T2S instruction reference	Shows the underlying T2S reference of the settlement instruction or settlement restriction.
Entry date time	Shows the date and time the amendment instruction entered T2S. Displayed format is: YYYY-MM-DD hh:mm:ss:µsµsµsµsµs
Approval status	Shows the matching status of the amendment instruction. Possible values: <ul style="list-style-type: none"> <input type="checkbox"/> APPR (Approved) <input type="checkbox"/> AWAP (Awaiting approval) <input type="checkbox"/> REJT (Rejected) <input type="checkbox"/> RVKD (Revoked)
Execution status	Shows the execution status of the amendment instruction. Possible values: <ul style="list-style-type: none"> <input type="checkbox"/> EXCD (executed) <input type="checkbox"/> NEXD (not executed)
Original Instructed settlement quantity	Shows the original instructed quantity of securities of the underlying instruction in units or face amount.
Original Instructed settlement amount	Shows the original instructed amount of the underlying instruction in the instruction’s currency. {CR-819}
Referenced instruction type	Shows the type of instruction of the referenced instruction: Possible values:

INX07 – Multi-criteria search of a set of amendment instructions – List Screen	
	<input type="checkbox"/> STIN (settlement instruction) <input type="checkbox"/> STRN (settlement restriction)
Partial settlement indicator	Shows if the amendment instruction allows partial settlement and indicates the threshold type. Possible values: <input type="checkbox"/> NPAR (partial not allowed) <input type="checkbox"/> PART (partial allowed) <input type="checkbox"/> PARC (partial settlement cash threshold allowed) <input type="checkbox"/> PARQ (partial settlement quantity threshold allowed)
Priority	Shows the priority of the amendment instruction from the possible values: <input type="checkbox"/> 0001 (Reserved) <input type="checkbox"/> 0002 (Top) <input type="checkbox"/> 0003 (High) <input type="checkbox"/> 0004 (Normal)
Securities party BIC	Shows the BIC of the securities account owner.
Securities account number	Shows the securities account number of the underlying instruction.
Cash party BIC	Shows the BIC of the cash account owner.
T2S dedicated cash account number	Shows the T2S dedicated cash account number of the underlying instruction.

Screenshot

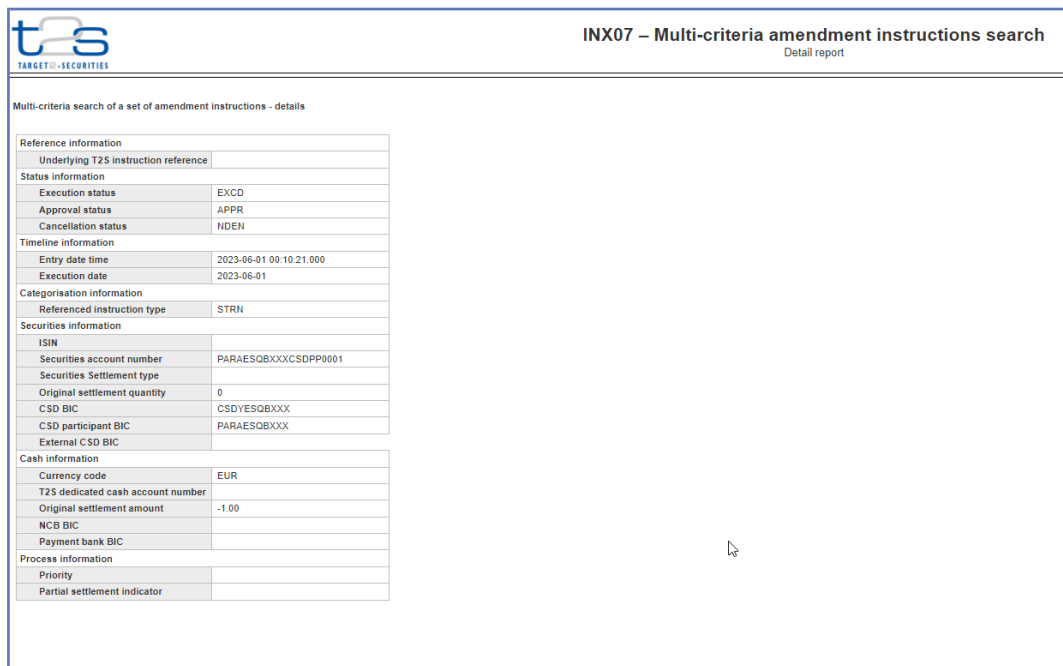

Illustration 343: INX07 details screen{CR-819}

Field Description

INX07 – Multi-criteria search of a set of amendment instructions – Details Screen	
Reference information	
Underlying T2S instruction reference	Shows the T2S reference of the settlement instruction or the settlement restriction.
Status information	
Execution status	Shows the execution status of the amendment instruction. Possible values: <input type="checkbox"/> EXCD (executed) <input type="checkbox"/> NEXD (not executed)
Approval status	Shows the matching status of the amendment instruction. Possible values: <input type="checkbox"/> APPR (Approved) <input type="checkbox"/> AWAP (Awaiting approval) <input type="checkbox"/> REJT (Rejected) <input type="checkbox"/> RVKD (Revoked)
Cancellation status	Shows the cancellation status of the amendment instruction. Possible values: <input type="checkbox"/> DEND (denied)

INX07 – Multi-criteria search of a set of amendment instructions – Details Screen	
	<input type="checkbox"/> NDEN (not denied)
Timeline information	
Entry date time	Shows the date and time the amendment instruction entered T2S. Displayed format is: YYYY-MM-DD hh:mm:ss,sssss
Execution date	Shows the execution date of the amendment instruction. Displayed format is: YYYY-MM-DD
Categorisation information	
Referenced instruction type	Shows the type of the referenced instruction: Possible values: <input type="checkbox"/> STIN (settlement instruction) <input type="checkbox"/> STRN (settlement restriction)
Securities information (Please note, that this part will not be filled for cancellations for settlement restrictions on cash)	
ISIN code	Shows the ISIN.
Securities account number	Shows the securities account number of the underlying instruction.
Securities settlement type	Shows the settlement type. Possible values: <input type="checkbox"/> NOMI (nominal) <input type="checkbox"/> UNIT (units)
Original Instructed settlement quantity	Shows the original instructed quantity of the securities of the underlying instruction in units or face amount. {CR-819}
CSD BIC	Shows the BIC of the CSD
CSD participant BIC	Shows the BIC of the CSD participant
External CSD BIC	Shows the BIC of the external CSD
Cash information (Please note, that this part will not be filled for cancellations for restrictions on securities or for cancellations for settlement instructions “FOP”)	
Currency code	Shows the currency code.

INX07 – Multi-criteria search of a set of amendment instructions – Details Screen	
T2S dedicated cash account number	Shows the T2S dedicated cash account number of the underlying instruction.
Original Instructed settlement amount	Shows the original instructed amount of the underlying instruction in the instruction’s currency. {CR-819}
NCB BIC	Shows the BIC of the NCB
Payment bank BIC	Shows the BIC of the payment bank
Process information	
Priority	Shows the priority of the amendment instruction from the possible values: <ul style="list-style-type: none"> <input type="checkbox"/> 0001 (Reserved) <input type="checkbox"/> 0002 (Top) <input type="checkbox"/> 0003 (High) <input type="checkbox"/> 0004 (Normal)
Partial settlement indicator	Shows if the amendment instruction allows partial settlement and indicates the threshold type. <p>Possible values:</p> <ul style="list-style-type: none"> <input type="checkbox"/> NPAR (partial not allowed) <input type="checkbox"/> PART (partial allowed) <input type="checkbox"/> PARC (partial settlement cash threshold allowed) <input type="checkbox"/> PARQ (partial settlement quantity threshold allowed) ⁸³

5.5.3.8 INX08 – Multi-criteria search of a set of hold and release instructions

Context of Usage

This report shows a list of details for selected hold and release instructions (HR), which it performs on two levels. In the first level, the report produces a list of HRIs corresponding to user-supplied filter criteria. In the second level, the user may select one HR from the list and the detailed report provides a full list of attributes for the selected HR.

The attributes shown in the detailed report output provide business details related to the selected HR.

This report can be used by CSD, ~~CSDP and ECSD~~ users. **{CR-819}**

83 This content is not applicable as of R6.2, and will become applicable upon the deployment of the Data Warehouse for T2S.

Report Access

This report can be reached in the following way:

- [Content >>](#) Team Content >> [T2S >>](#) Predefined Reports >> [INX](#)
- ▬ T2S Instructions >> INX08{CR-819}

Screenshot

The screenshot shows the 'INX08 – Prompt' interface. It features several sections for defining search criteria:

- Keywords:** A search box with 'Input keywords here' and a magnifying glass icon.
- Securities party BIC:** A list of BIC codes with checkboxes. The 'Select all' option is checked. The list includes: CSDACXMMXXX, CSDAESLRXX0, CSDAESLRXX0, CSDAESLRXX0, CSDAESLRXX0, CSDAESPAAAA, CSDAESPAAAA, CSDAESPAXXX, and CSDAESPAXXX. A 'Starts with any of these keywords' dropdown is below the list.
- Approval status:** A list of statuses: APPR, AWAP, REJT, and RVKD. 'Case Insensitive' is checked. 'Select all' and 'Deselect all' links are at the bottom.
- Hold status type:** A list of hold types: Party Hold, CSD Hold, CSD Validation, and Conditional Delivery. 'Select all' and 'Deselect all' links are at the bottom.
- Hold indicator:** A list of indicators: TRUE (HOLD) and FALSE (RELEASE). 'Select all' and 'Deselect all' links are at the bottom.
- Range criteria:** 'From' and 'To' date pickers. 'From' is set to Jul 1, 2023 and 'To' is set to Sep 18, 2023.

On the right side, there is a list titled 'Please search and select the securities party BIC' containing the same BIC codes as the left list. 'Select all' and 'Deselect all' links are at the bottom of this list.

Illustration 344: INX08 prompt screen {CR-819}

Field Description

INX08 – Multi-criteria search of a set of hold and release instructions – Prompt Screen	
Securities party BIC	Filter to select which securities party BIC (CSDs, CSD participants or ECSDs) value/s should be included in the output. <u>This field mandatory.</u>

INX08 – Multi-criteria search of a set of hold and release instructions – Prompt Screen	
Cash party BIC	Filter to select which cash party BIC (NCB or payment bank) value/s should be included in the output. {CR-819}
Approval status	Filter to select which securities account number value/s should be included in the output.
Hold status type	Multiple selection text field to enter T2S DCA number value/s that should be included in the output.
Hold indicator	Filter to select which referenced instruction types should be included in the output. Possible values: <input type="checkbox"/> STIN (Settlement instruction) <input type="checkbox"/> STRN (Settlement restriction)
Entry date time from	Filter to select which partial settlement indicator value/s should be included in the output. Possible values: <input type="checkbox"/> NPAR <input type="checkbox"/> PART <input type="checkbox"/> PARC <input type="checkbox"/> PARQ
Entry date time to	Filter to select which priority value/s should be included in the output. Possible values: <input type="checkbox"/> 0001 <input type="checkbox"/> 0003 <input type="checkbox"/> 0004

Screenshot

Underlying T2S instruction reference	Entry date time	Approval status	Hold status type	Hold indicator	ISIN	Securities party BIC
2307070528333937	2023-07-07 15:41:25.897	APPR	CDEL	T		CSDBHJHCXXX
2307070528409918	2023-07-07 16:29:47.629	APPR	CDEL	T		CSDGESFXXXX
2307070528421649	2023-07-07 17:41:25.000	APPR	PTYH	F		CSDAHUHBXXX
2307070528422590	2023-07-07 17:20:50.000	APPR	CSDH	F		CSDAHUHBXXX
2307070528422590	2023-07-07 17:29:05.000	APPR	CVAL	F		CSDAHUHBXXX
2307070528423805	2023-07-07 17:12:34.614	APPR	CDEL	T		CSDBHJHCXXX
2307160528439104	2023-07-10 09:35:52.788	APPR	CDEL	T		CSDGESFXXXX
2307160528439105	2023-07-10 09:35:53.230	APPR	CDEL	T		CSDHESPHXXX
2307140528552819	2023-07-14 09:30:31.000	APPR	PTYH	F		CSDAHUHBXXX
2307140528553043	2023-07-14 09:08:43.000	APPR	CSDH	F		CSDAHUHBXXX
2307140528553043	2023-07-14 09:17:36.000	APPR	CVAL	F		CSDAHUHBXXX
2307140528556117	2023-07-14 09:00:02.642	APPR	CDEL	T		CSDBHJHCXXX
2307140528577745	2023-07-14 15:58:16.465	APPR	CDEL	T		CSDHESPHXXX
2307140528577907	2023-07-14 16:16:18.266	APPR	CDEL	T		CSDHESPHXXX
230718528668036	2023-07-21 11:08:06.000	APPR	PTYH	F		CSDAHUHBXXX
230718528670139	2023-07-21 10:46:04.000	APPR	CSDH	F		CSDAHUHBXXX
2307210528709139	2023-07-21 10:54:58.000	APPR	CVAL	F		CSDAHUHBXXX
2307210528720300	2023-07-21 10:37:38.803	APPR	CDEL	T		CSDBHJHCXXX
2307210528775864	2023-07-27 13:29:25.000	APPR	PTYH	F		CSDAHUHBXXX
2307210528777042	2023-07-27 13:07:49.000	APPR	CSDH	F		CSDAHUHBXXX

Illustration 345: INX08 list screen{CR-819}

Field Description

INX08 – Multi-criteria search of a set of hold and release instructions – List Screen	
Number of hold and release instructions	Count of the number of hold and release instructions resulting from the filter screen. (For each hold/release instruction matching the selection criteria, one line will be displayed)
Underlying T2S instruction reference	Shows the reference of the underlying T2S instruction (settlement instruction or settlement restriction)
Entry date time	Shows the date and time the hold or release instruction entered T2S. Displayed format is: YYYY-MM-DD hh:mm:ss, sssss{CR-819}
Approval status	Shows the matching status of the hold or release instruction. Possible values: <input type="checkbox"/> APPR (Approved) <input type="checkbox"/> AWAP (Awaiting approval) <input type="checkbox"/> REJT (Rejected) <input type="checkbox"/> RVKD (Revoked)
Hold status type	Shows the hold status for the instructions. Possible values: <input type="checkbox"/> CoSD hold <input type="checkbox"/> Party hold <input type="checkbox"/> CSD hold

INX08 – Multi-criteria search of a set of hold and release instructions – List Screen	
	<input type="checkbox"/> CSD validation hold
Hold indicator	Shows the CSD hold status. Possible values: <input type="checkbox"/> Yes (when the instruction intends to hold an instruction) <input type="checkbox"/> No (when the instruction intends to release an instruction)
ISIN	Shows the unique identification of the securities from a business point of view.
Securities party BIC	Shows the BIC of the owner of the securities account.

Screenshot

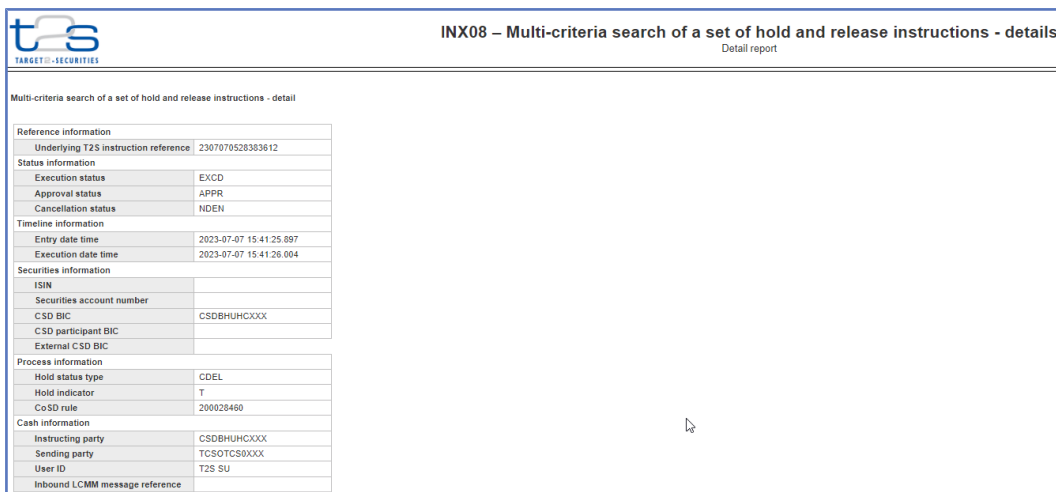

Illustration 346: INX08 details screen{CR-819}

Field Description

INX08 – Multi-criteria search of a set of hold and release instructions – Details Screen	
Reference information	
Underlying T2S instruction reference	Shows the T2S reference of the settlement instruction or the settlement restriction.
Status information	
Execution status	Shows the execution status of the hold or release instruction. Possible values: <input type="checkbox"/> EXCD (executed) <input type="checkbox"/> NEXD (not executed)

INX08 – Multi-criteria search of a set of hold and release instructions – Details Screen	
Approval status	Shows the matching status of the hold or release instruction. Possible values: <input type="checkbox"/> APPR (Approved) <input type="checkbox"/> AWAP (Awaiting approval) <input type="checkbox"/> REJT (Rejected) <input type="checkbox"/> RVKD (Revoked)
Cancellation status	Shows the cancellation status of the hold or release instruction. Possible values: <input type="checkbox"/> DEND (denied) <input type="checkbox"/> NDEN (not denied)
Timeline information	
Entry date time	Shows the date and time the hold or release instruction entered T2S. Displayed format is: YYYY-MM-DD hh:mm:ss,sssss
Execution date <u>time</u>	Shows the date <u>and time</u> of the execution of the hold/release instruction. Displayed format is : YYYY-MM-DD <u>and</u> <u>hh:mm:ss</u> .{CR-819}
Securities information	
ISIN	Shows the ISIN.
Securities account number	Shows the securities account number of the underlying instruction.
CSD BIC	Shows the BIC of the CSD
CSD participant BIC	Shows the BIC of the CSD participant
External CSD BIC	Shows the BIC of the external CSD
Process Information	
<u>Hold status type</u>	<u>Shows the hold status for the instructions.</u> <u>Possible values:</u> <input type="checkbox"/> <u>CoSD hold</u> <input type="checkbox"/> <u>Party hold</u> <input type="checkbox"/> <u>CSD hold</u> <input type="checkbox"/> <u>CSD validation hold</u>

INX08 – Multi-criteria search of a set of hold and release instructions – Details Screen	
<u>Hold indicator</u>	<p><u>Shows the CSD hold status.</u></p> <p><u>Possible values:</u></p> <ul style="list-style-type: none"> <input type="checkbox"/> <u>On hold (when the instruction intends to hold an instruction)</u> <input type="checkbox"/> <u>Released (when the instruction intends to release an instruction)</u>
<u>CoSD rule</u>	<u>Shows the T2S reference for the CoSD rule.</u> {CR-819}
Communication information	
Instructing party	Shows the T2S reference of the party that instructs the LCMM instruction.
Sending party	Shows the T2S reference of the party that sent the LCMM instruction.
User Id	Shows the T2S reference of the user.
Inbound LCMM message reference	Shows the incoming message reference assigned by the T2S actor. ⁸⁴

5.5.3.9 INX09 – Multi-criteria search of a set of liquidity transfers

Context of Usage

This report shows a list of details for selected finalised liquidity transfers (LT), which it performs on two levels. In the first level, the report produces a list of LTs corresponding to user-supplied filter criteria. In the second level, the user may select one LT from the list and the detailed report provides a full list of attributes for selected LT.

The attributes shown in the detailed report output provide business details related to the selected LT.

This report can be used by **NCB and PB** users.{CR-819}

Report Access

This report can be reached in the following way:

- Content >>** Team Content >> **T2S >>** Predefined Reports >> **INX**
 :- T2S Instructions >> INX09{CR-819}

84 This content is not applicable as of R6.2, and will become applicable upon the deployment of the Data Warehouse for T2S.

Screenshot

INX09 – Prompt

Cash party BIC:

Keywords:

Input keywords here

Select all

- PBAAALD0XXX
- PBAAAQD0XXX
- PBAAAXD0XXX
- PBAABAD0XXX
- PBAABYD0XXX
- PBAACMF0EUR
- PBAACMF0XXX

Starts with any of these keywords

Case Insensitive

Keywords:

Input keywords here

Select all

No Results

Starts with any of these keywords

Case Insensitive

Keywords:

Input keywords here

Select all

No Results

Starts with any of these keywords

Case Insensitive

Please search and select the cash party BIC

- PBAAALD0XXX
- PBAAAQD0XXX
- PBAAAXD0XXX
- PBAABAD0XXX
- PBAABYD0XXX
- PBAACMF0EUR
- PBAACMF0XXX
- PBAACXD0XXX
- PBAAESD0XXX
- PBAAFOD0XXX
- PBAAGLD0XXX
- PBAACRATXXX

Select all Deselect all

Please search and select the debited account number

Select all Deselect all

Please search and select the credited account number

Select all Deselect all

Cashed account number:

Credited account number:

Transfer type:	IBLT OTLT INLT Select all Deselect all	
Underlying transfer type:	SLTO PLTO ILTO Select all Deselect all	
Settlement transaction category:	LQTR TCAT Select all Deselect all	
Settlement transaction sub-category:	LQTR LTAC EDLT MPOR CARL ALOP Select all Deselect all	
Currency code:	DKK EUR Select all Deselect all	
Approval status:	APPR - Approved AWAP - Awaiting approval REJE - Rejected REVO - Revoked Select all Deselect all	
Settlement status:	SNXE - Not executed SUNS - Unsettled SPAS - Partially settled SSET - Settled Select all Deselect all	
Range criteria	From	To
Settlement date:	Jun 1, 2023	Sep 18, 2023
Transfer amount:	<input type="text"/>	<input type="text"/>
Settled amount:	<input type="text"/>	<input type="text"/>

Illustration 347: INX09 prompt screen {CR-819}

Field Description

INX09 – Multi-criteria search of a set of liquidity transfers – Prompt Screen	
Cash party BIC	Filter to select which cash party BIC value/s should be included in the output.
Debited account number	Filter to select which T2S DCA number value/s should be included in the output.
Credited account number	Filter to select which T2S DCA number value/s should be included in the output.

INX09 – Multi-criteria search of a set of liquidity transfers – Prompt Screen	
Transfer type	<p>Filter to select which transfer types should be included in the output.</p> <p>Possible values:</p> <ul style="list-style-type: none"> <input type="checkbox"/> IBLT <input type="checkbox"/> OTLT <input type="checkbox"/> INLT
Underlying transfer type	<p>Filter to select which underlying transfer types should be included in the output.</p> <p>Possible values:</p> <ul style="list-style-type: none"> <input type="checkbox"/> SLTO <input type="checkbox"/> PLTO <input type="checkbox"/> ILTO
Settlement transaction category	<p>Filter to select which settlement transaction categories should be included in the output.</p> <p>Possible values:</p> <ul style="list-style-type: none"> <input type="checkbox"/> LQTR <input type="checkbox"/> TCAT
Settlement transaction sub-category	<p>Filter to select which settlement transaction sub-categories should be included in the output.</p> <p>Possible values:</p> <ul style="list-style-type: none"> <input type="checkbox"/> LQTR <input type="checkbox"/> LTAC <input type="checkbox"/> EDLT <input type="checkbox"/> MPOR <input type="checkbox"/> CARL <input type="checkbox"/> ALOP
Currency code	<p>The report output contains only settlement instructions with the selected settlement currency codes.</p>
Approval status	<p>Filter to select which approval status value/s should be included in the output.</p> <p>Possible values:</p> <ul style="list-style-type: none"> <input type="checkbox"/> APPR <input type="checkbox"/> AWAP

INX09 – Multi-criteria search of a set of liquidity transfers – Prompt Screen	
	<input type="checkbox"/> REJE <input type="checkbox"/> RVKD
Settlement status	Filter to select which settlement status value/s should be included in the output. Possible values: <input type="checkbox"/> CANC <input type="checkbox"/> USET <input type="checkbox"/> PSET <input type="checkbox"/> SETT <input type="checkbox"/> <u>SNXE</u> <input type="checkbox"/> <u>SUNS</u> <input type="checkbox"/> <u>SPAS</u> <input type="checkbox"/> <u>SSET{CR-819}</u>
Settlement date from	Filter to select the inclusive date from which settlement date value/s should be included in the output. Must be used in conjunction with: <input type="checkbox"/> settlement date to
Settlement date to	Filter to select the inclusive date up to which settlement date value/s should be included in the output. Must be used in conjunction with: <input type="checkbox"/> settlement date from
Transfer amount from	Filter to select the inclusive amount from which transfer amount value/s should be included in the output. Must be used in conjunction with: <input type="checkbox"/> Transfer amount to <input type="checkbox"/> Currency code
Transfer amount to	Filter to select the inclusive amount up to which transfer amount value/s should be included in the output.

INX09 – Multi-criteria search of a set of liquidity transfers – List Screen	
Referred-reference End-to-End ID	Shows the <u>End-to-End ID provided by the originator of the liquidity transfer order. reference of a settlement instruction to which the liquidity transfer is linked.</u> {CR-819}
Entry timestamp	Shows the date and the time the liquidity transfer entered or was generated in T2S. Displayed format: YYYY-MM-DD hh:mm:ss,sssss
Settlement timestamp	Shows the date and the time of the attempted settlement in T2S. Displayed format: YYYY-MM-DD hh:mm:ss,sssss
Approval status	Shows approval status of the liquidity transfer. Possible values: <input type="checkbox"/> AWAP (Awaiting approval) <input type="checkbox"/> APPR (Approved) <input type="checkbox"/> REJE (Rejected) <input type="checkbox"/> RVKD (Revoked)
Settlement status	Shows the settlement status of the liquidity transfer. Possible values: <input type="checkbox"/> CANC (Cancelled) <input type="checkbox"/> SETT (Settled) <input type="checkbox"/> USET (Unsettled) <input type="checkbox"/> PSET (Partially settled) <input type="checkbox"/> <u>SNXE (Not executed)</u> <input type="checkbox"/> <u>SUNS (=Unsettled)</u> <input type="checkbox"/> <u>SPAS (=Partially settled)</u> <input type="checkbox"/> <u>SSET (=Settled)</u>{CR-819}
Currency code	Shows the settlement currency of the liquidity transfer.
Transfer amount	Shows the amount to be credited or debited by the liquidity transfer.
Settled amount	Shows the amount actually settled by the liquidity transfer.
Transfer type	Shows the direction of the transferred liquidity. Possible values: <input type="checkbox"/> IBLT (inbound liquidity transfer) <input type="checkbox"/> OTLT (outbound liquidity transfer)

INX09 – Multi-criteria search of a set of liquidity transfers – List Screen	
	<input type="checkbox"/> INLT (internal liquidity transfer order)
Underlying transfer type	Shows the type of the transferred liquidity. Possible values: <input type="checkbox"/> SLTO (standing liquidity transfer order) <input type="checkbox"/> PLTO (predefined liquidity transfer order) <input type="checkbox"/> ILTO (immediate liquidity transfer order)
Settlement transaction category	Shows the settlement transaction category of the liquidity transfer. Possible values: <input type="checkbox"/> LQTR (liquidity transfer) <input type="checkbox"/> TCAT (technical cash transfer)
Settlement transaction sub-category	Shows the settlement transaction sub-category of the liquidity transfer. Possible values: <input type="checkbox"/> LQTR (liquidity transfer) <input type="checkbox"/> LTAC (Liquidity transfer all cash) <input type="checkbox"/> EDLT (EoD liquidity transfer) <input type="checkbox"/> MPOR (monetary policy operation cash rebalancing) <input type="checkbox"/> CARL (corporate action cash rebalancing) <input type="checkbox"/> ALOP (auto-collateralisation liquidity optimization)
Debited party BIC	Shows the BIC of the payment bank which owns the debited account.
Debited account number	Shows the account number from which the liquidity is sent.
Credited party BIC	Shows the BIC of the payment bank which owns the credited account.
Credited account number	Shows the account identification or number to where the liquidity is sent.

Screenshot

Reference information	
Liquidity transfer instructor reference	
Referred reference	0000000051339420
Status information	
Approval status	APPR
Settlement status	SSET
RTGS status	
Timeline information	
Entry timestamp	9999-01-01 00:00:00.000
Settlement timestamp	2023-08-18 12:45:02.849
Categorisation information	
Transfer type	2
Underlying transfer type	SLTO
Settlement transaction category	TCAT
Settlement transaction sub-category	ALOP
Cash information	
Currency code	EUR
Transfer amount	0.00
Settled amount	20.00
Value date	2023-08-18
Cash parties	
Debited party BIC	PBKDHUAA00XX
Debited account number	PBKDHUAA00XXDCAEURP02
Credited party BIC	PBKDHUAA00XX
Credited account number	PBKDHUAA00XXDCAEURP05
NCB BIC	NCBDHUAA00XX
Process information	
Partial settlement flag	0

Illustration 349: INX09 details screen {CR-819}

Field Description

INX09 – Multi-criteria search of a set of liquidity transfers – Details Screen	
Reference information	
Liquidity transfer instructor reference	Shows the instructor reference of the liquidity transfer.
Referred reference	Shows the reference of a settlement instruction to which the liquidity transfer is linked.
Status information	
Approval status	Shows approval status of the liquidity transfer. Possible values: <input type="checkbox"/> AWAP (Awaiting approval) <input type="checkbox"/> APPR (Approved) <input type="checkbox"/> REJE (Rejected) <input type="checkbox"/> RVKD (Revoked)
Settlement status	Shows the settlement status of the liquidity transfer. Possible values: <input type="checkbox"/> CANC (Cancelled) <input type="checkbox"/> SETT (Settled) <input type="checkbox"/> USET (Unsettled) <input type="checkbox"/> PSET (Partially settled) <input type="checkbox"/> SNXE (Not executed) <input type="checkbox"/> SUNS (=Unsettled)

INX09 – Multi-criteria search of a set of liquidity transfers – Details Screen	
	<input type="checkbox"/> <u>SPAS (=Partially settled)</u> <input type="checkbox"/> <u>SSET (=Settled){CR-819}</u>
RTGS status	<p>Shows the RTGS status of the liquidity transfer.</p> <p>Possible values:</p> <ul style="list-style-type: none"> <input type="checkbox"/> RNXE (Not executed) <input type="checkbox"/> RNAP (Not applicable) <input type="checkbox"/> RREJ (RTGS rejection) <input type="checkbox"/> RCON (RTGS confirmation) <input type="checkbox"/> RBOK (RTGS rebooking)
Timeline information	
Entry timestamp	<p>Shows the date and the time the liquidity transfer entered or was generated in T2S.</p> <p>Displayed format: YYYY-MM-DD hh:mm:ss,sssss</p>
Settlement timestamp	<p>Shows the date and the time of the attempted settlement in T2S.</p> <p>Displayed format: YYYY-MM-DD hh:mm:ss,sssss</p>
Securities information	
Transfer type	<p>Shows the direction of the transferred liquidity.</p> <p>Possible values:</p> <ul style="list-style-type: none"> <input type="checkbox"/> IBLT (inbound liquidity transfer) <input type="checkbox"/> OTLT (outbound liquidity transfer) <input type="checkbox"/> INLT (internal liquidity transfer order)
Underlying transfer type	<p>Shows the type of the transferred liquidity.</p> <p>Possible values:</p> <ul style="list-style-type: none"> <input type="checkbox"/> SLTO (standing liquidity transfer order) <input type="checkbox"/> PLTO (predefined liquidity transfer order) <input type="checkbox"/> ILTO (immediate liquidity transfer order)
Settlement transaction category	<p>Shows the settlement transaction category of the liquidity transfer.</p> <p>Possible values:</p> <ul style="list-style-type: none"> <input type="checkbox"/> LQTR (liquidity transfer) <input type="checkbox"/> TCAT (technical cash transfer)

INX09 – Multi-criteria search of a set of liquidity transfers – Details Screen	
Settlement transaction sub-category	Shows the settlement transaction sub-category of the liquidity transfer. Possible values: <input type="checkbox"/> LQTR (liquidity transfer) <input type="checkbox"/> LTAC (Liquidity transfer all cash) <input type="checkbox"/> EDLT (EoD liquidity transfer) <input type="checkbox"/> MPOR (monetary policy operation cash rebalancing) <input type="checkbox"/> CARL (corporate action cash rebalancing) <input type="checkbox"/> ALOP (auto-collateralisation liquidity optimization)
Cash information	
Currency code	Shows the settlement currency of the liquidity transfer.
Transfer amount	Shows the amount to be credited or debited by the liquidity transfer.
Settled amount	Shows the amount actually settled by the liquidity transfer.
Value date	Shows the date at which the liquidity transfer becomes effective. Displayed format is: YYYY-MM-DD
Cash parties	
Debited account number	Shows the account number from which the liquidity is sent.
Debited party BIC	Shows the BIC of the payment bank which owns the debited account.
Credited account number	Shows the account identification or number to where the liquidity is sent.
Credited party BIC	Shows the BIC of the payment bank which owns the credited account.
NCB BIC	BIC of the NCB
Process information	
Partial settlement flag	Shows if partial execution was possible or not. Possible values: <input type="checkbox"/> F (false – partial not allowed) <input type="checkbox"/> T (true – partial settlement allowed) ⁸⁵

5.5.4 T2S Restrictions (RES)

5.5.4.1 RES01 – Detailed cash restrictions

Context of Usage

This report shows volumes and values for all finalised cash restrictions at CB, PB or T2S DCA level, during a selected period of time. The restrictions are filtered according to the currency that the user selects.

The report delivers the volume and value of cash restrictions finalised during the selected period whether settled or partially settled. The results are displayed aggregated per transaction sub-category, within origin, restriction type and function. Totals are presented at origin level, but also cross-totalled by function.

This report can be used by CB **and PB** users. **{CR-819}**

Report Access

This report can be reached in the following way:

- [Content >>](#) Team Content >> [T2S >>](#) Predefined Reports >> [RES -](#) T2S Restrictions >> RES01 **{CR-819}**

Screenshot

Illustration 350: RES01 prompt screen {CR-819}

Field

Description

RES01 – Detailed cash restrictions – Prompt Screen	
Date From	You can select the date by clicking on the calendar. This field is mandatory.
Date To	You can select the end date of the period, for which the report should contain the data by clicking on the calendar. For valid report results, the current day cannot be selected. This field is mandatory.
Currency	You can use this drop-down field to select the currency. This field is mandatory.

RES01 – Detailed cash restrictions – Prompt Screen	
Party BIC	You can use this drop-down field to select one or several party BIC. This field will show all related BICs, which belong to the default data scope of the user’s party. This field is optional.
T2S DCA number	You can use this drop-down field to select one or several T2S DCA numbers. This field will show all related T2S DCAs, which belong to default data scope of the user’s party and which belong to the parties selected in field “Party BIC”. If no Party BICs are selected, this field shows all T2S DCA numbers belonging to the default data scope of the user’s party. This field is optional.

Screenshot

Origin	Restriction type	Function	Settlement transaction sub-category	Volume of restrictions	Original value	Settled value
Business	Blocking	Decrease	BPDE	10	15,764.92	15,764.92
		Setup / increase	BPSU	1,857	1,633,508,159.23	1,633,508,134.23
	Reservation	Decrease	BPIN	24	21,936.00	21,936.00
			RPDE	159	153,980.20	86,580.20
		Setup / increase	RPSU	2,202	51,918,273.42	1,801,730.40
			RPIN	22	2,270,292.00	2,270,292.00
Total Business cash restrictions				4,274	1,687,888,405.77	1,637,704,437.75
Technical	COSD Blocking	Decrease	COCB	271	1,800,201,904.00	1,800,201,904.00
		Setup / increase	COBR	879	10,601,322,842.00	10,601,322,842.00
			COBS	803	5,801,304,536.00	5,801,304,536.00
	End of day	Decrease	CORU	217	570,290.00	570,290.00
			EDRR	3,467	13,332,589,422.69	13,332,589,422.69
		Total Technical cash restrictions				5,637
Usage	Use	Use	RESU	521	9,873,933.92	9,873,933.92
		Total Usage cash restrictions				521
				5,620	32,380,258,774.42	32,380,212,829.42
Total cash restrictions				5,620	32,380,258,774.42	32,380,212,829.42
Total setup / increase				5,787	18,090,346,038.65	18,040,229,470.63
Total decrease				4,124	15,133,531,361.81	15,133,463,961.81
Total use				521	9,873,933.92	9,873,933.92
Total				16,052	65,614,010,108.80	65,563,780,196.78

Illustration 351: RES01 output screen{CR-819}

Field Description

RES01 – Detailed cash restrictions – Output Screen	
Origin	Describes a group of transaction sub-categories. Groups are: <ul style="list-style-type: none"> <input type="checkbox"/> Business <input type="checkbox"/> Technical <input type="checkbox"/> Usage
Restriction type	Describes a restriction type within an origin. Restriction types are: <ul style="list-style-type: none"> <input type="checkbox"/> Business

RES01 – Detailed cash restrictions – Output Screen	
	<input type="checkbox"/> Blocking <input type="checkbox"/> Reservation <input type="checkbox"/> Technical <input type="checkbox"/> COSD blocking <input type="checkbox"/> End of day <input type="checkbox"/> Usage <input type="checkbox"/> Use
Function	Describes a function within a restriction type. Functions are: <input type="checkbox"/> Setup / increase <input type="checkbox"/> Decrease <input type="checkbox"/> Use (for Use restriction type only)
Transaction sub-category	The transaction sub-category of the restrictions for which the aggregations are performed. Values used, as per their origin and restriction type: <input type="checkbox"/> Business <input type="checkbox"/> Blocking <input type="checkbox"/> BPIN, BPSU, BPDE <input type="checkbox"/> Reservation <input type="checkbox"/> RPIN, RPSU, RPDE <input type="checkbox"/> Technical <input type="checkbox"/> COSD blocking <input type="checkbox"/> COBR, COBS, COCP <input type="checkbox"/> End of day <input type="checkbox"/> CORU, EDRR, RERV <input type="checkbox"/> Usage <input type="checkbox"/> Use <input type="checkbox"/> CORT, RESU
Volume of restrictions	Count of the number of cash restrictions found per sub-category.
Original Instructed value	Sum over original instructed values of the cash restrictions per sub-category{ CR-819 }

RES01 – Detailed cash restrictions – Output Screen	
Settled value	Sum over settled values (totally or partially settled) per and sub-category
Revoked	A count of all finalised inbound LTs which were revoked after settlement, per transaction category / transaction sub-category / underlying transaction type.
Value of transfers	Sum of the original instructed transfer amounts of all finalised inbound LTs, per transaction category / transaction sub-category / underlying transaction type.
Value actually transferred	Sum of the actual settled amounts of all finalised inbound LTs, per transaction category / transaction sub-category / underlying transaction type.
Totals (per origin)	
Total business cash restrictions	Sums for 'Volume of restrictions', ' Original Instructed value ' and 'Settled value' columns, within the origin 'Business'.
Total technical cash restrictions	Sums for 'Volume of restrictions', ' Original Instructed value ' and 'Settled value' columns, within the origin 'Technical'.
Total usage cash restrictions	Sums for 'Volume of restrictions', ' Original Instructed value ' and 'Settled value' columns, within the origin 'Usage'. {CR-819}
Totals (per function)	
Total setup / increase	Sums for 'Volume of restrictions', ' Original Instructed value ' and 'Settled value' columns, to include all lines with the function 'Setup / increase'.
Total decrease	Sums for 'Volume of restrictions', ' Original Instructed value ' and 'Settled value' columns, to include all lines with the function 'Decrease'.
Total use	Sums for 'Volume of restrictions', ' Original Instructed value ' and 'Settled value' columns, to include all lines with the function 'Use'. {CR-819}
Total (overall)	
Total	Sums for 'Volume of restrictions', ' Original Instructed value ' and 'Settled value' columns, over all 'Totals (per function)'. ⁸⁶ {CR-819}

5.5.4.2 RES02 – Detailed securities restrictions

Context of Usage

This report shows volumes and quantities for all finalised securities restrictions at CSD, CSDP, ECSD or securities account level, during a selected period of time. The restrictions are filtered according to the settlement types of the securities that the user selects.

The report delivers the volume of securities restrictions finalised during the selected period whether settled or partially settled. The results are displayed aggregated per transaction sub-category, within origin, restriction type and function. Totals are presented at origin level, but also cross-totalled by function.

This report can be used by CSD, ~~CSDP and ECSD~~ users. **{CR-819}**

Report Access

This report can be reached in the following way:

- [Content >>](#) Team Content >> [T2S >>](#) Predefined Reports >> [RES -](#) T2S Restrictions >> RES02 **{CR-819}**

Screenshot

Illustration 352: RES02 prompt screen {CR-819}

Field

Description

RES02 – Detailed securities restrictions – Prompt Screen	
Date From	You can select the date by clicking on the calendar. This field is mandatory.
Date To	You can select the end date of the period, for which the report should contain the data by clicking on the calendar.

RES02 – Detailed securities restrictions – Prompt Screen	
	<p>For valid report results, the current day cannot be selected.</p> <p>This field is mandatory.</p>
Settlement type	<p>This selection specifies the quantity type of the settlement for the security, stated in the restriction transaction.</p> <p>Possible values:</p> <ul style="list-style-type: none"> <input type="checkbox"/> Unit <input type="checkbox"/> Nominal <p>This field is mandatory</p>
Party BIC	<p>You can use this drop-down field to select one or several party BIC. This field will show all related BICs, which belong to the default data scope of the user's party.</p> <p>This field is optional.</p>
Securities account number	<p>You can use this drop-down field to select one or several securities account numbers. This field will show all related securities accounts which belong to default data scope of the user's party and which belong to the parties selected in field "Party BIC". If no Party BICs are selected, this field shows all securities account numbers belonging to the default data scope of the user's party.</p> <p>This field is optional.</p>
Securities ISIN{CR-819}	<p>The report output contains only settlement instructions with the selected securities.</p> <p>This field is optional.</p>

Screenshot

t2s		RES02 - Detailed securities restrictions					
TARGET - SECURITIES		CSDYATFF801 - CSD-AT-Range8 - AB					
Filters		Date from	: 2021-02-18	Date to:	2023-12-18		
		Settlement type:	FAMT - Nominal				
Detailed securities restrictions							
Origin	Restriction type	Function	Transaction sub-category	Volume of restrictions	Instructed quantity	Settled quantity	
Business	Blocking	Setup / increase	BPSU	1	1,000	1,000	
Total Business securities restrictions				1	1,000	1,000	
Total setup / increase				1	1,000	1,000	
Total decrease				0	0	0	
Total use				0	0	0	
Total				1	1,000	1,000	

Illustration 353: RES02 output screen{CR-819}

RES02 – Detailed securities restrictions – Output Screen	
Field Description	
Origin	<p>Describes a group of transaction sub-categories. Groups are:</p> <ul style="list-style-type: none"> <input type="checkbox"/> Business <input type="checkbox"/> Technical <input type="checkbox"/> Usage
Restriction type	<p>Describes a restriction type within an origin. Restriction types are:</p> <ul style="list-style-type: none"> <input type="checkbox"/> Business <input type="checkbox"/> Blocking <input type="checkbox"/> Earmarking <input type="checkbox"/> Reservation <input type="checkbox"/> Technical <input type="checkbox"/> Collateralisation (COLA) <input type="checkbox"/> COSD blocking <input type="checkbox"/> End of day <input type="checkbox"/> Reverse Collateralisation (RCOL) <input type="checkbox"/> Usage <input type="checkbox"/> Use
Function	<p>Describes a function within a restriction type. Functions are:</p> <ul style="list-style-type: none"> <input type="checkbox"/> Decrease <input type="checkbox"/> Setup / increase <input type="checkbox"/> Use (for Use restriction type only)
Transaction sub-category	<p>The transaction sub-category of the restrictions for which the aggregations are performed. Values used, as per their origin and restriction type:</p> <ul style="list-style-type: none"> <input type="checkbox"/> Business <input type="checkbox"/> Blocking <input type="checkbox"/> BPDE, BPIN, BPSU <input type="checkbox"/> Earmarking <input type="checkbox"/> EPDE, EPIS <input type="checkbox"/> Reservation <input type="checkbox"/> RPDE, RPIN, RPSU

RES02 – Detailed securities restrictions – Output Screen	
	<input type="checkbox"/> Technical <input type="checkbox"/> Collateralisation (COLA) <input type="checkbox"/> SPLE (COLA) <input type="checkbox"/> COSD blocking <input type="checkbox"/> COBS, COCP <input type="checkbox"/> End of day <input type="checkbox"/> CORU <input type="checkbox"/> Reverse Collateralisation (RCOL) <input type="checkbox"/> SPLE(RCOL) <input type="checkbox"/> Usage <input type="checkbox"/> Use <input type="checkbox"/> CORT, RESU
Volume of restrictions	Count of the number of securities restrictions found per sub-category.
Original Instructed quantity	Sum over original instructed quantities of the securities restrictions per sub-category{CR-819}
Settled quantity	Sum over settled quantities (totally or partially settled) per and sub-category
Totals (per origin)	
Total business securities restrictions	Sums for 'Volume of restrictions', ' Original Instructed quantity' and 'Settled quantity' columns, within the origin 'Business'.
Total technical securities restrictions	Sums for 'Volume of restrictions', ' Original Instructed quantity' and 'Settled quantity' columns, within the origin 'Technical'.
Total usage securities restrictions	Sums for 'Volume of restrictions', ' Original Instructed quantity' and 'Settled quantity' columns, within the origin 'Usage'.{CR-819}
Totals (per function)	
Total setup / increase	Sums for 'Volume of restrictions', ' Original Instructed quantity' and 'Settled quantity' columns, to include all lines with the function 'Setup / increase'.

RES02 – Detailed securities restrictions – Output Screen	
Total decrease	Sums for ‘Volume of restrictions’, ‘ Original Instructed quantity’ and ‘Settled quantity’ columns, to include all lines with the function ‘Decrease’.
Total use	Sums for ‘Volume of restrictions’, ‘ Original Instructed quantity’ and ‘Settled quantity’ columns, to include all lines with the function ‘Use’. {Cr-819}
Total (overall)	
Total	Sums for ‘Volume of restrictions’, ‘ Original Instructed quantity’ and ‘Settled quantity’ columns, over all ‘Totals (per function)’. ⁸⁷ {CR-819}

5.5.5 T2S Credit line (CMB)

5.5.5.1 CMB01 – Journaling of limit utilisations of primary CMB

Context of Usage

This report shows primary CMB limit utilisation journal activity at CB, T2S CB-DCA or primary CMB level during a selected period of time. The accounts are filtered according the currency that the user selects. Primary CMBs are those set by a CB for a payment bank.

The journal activity is displayed as a table of volumes and utilisation values according to the credit/debit indicator.

This report can be used by CB users.

Report Access

This report can be reached in the following way:

- [Content >>](#) Team Content >> [T2S >>](#) Predefined Reports >> [CMB - T2S Credit Line](#) >> CMB01**{CR-819}**

87 This content is not applicable as of R6.2, and will become applicable upon the deployment of the Data Warehouse for T2S.

Screenshot

Illustration 354: CMB01 prompt screen (CR-819)

Field

Description

CMB01 – Journaling of limit utilisations of primary CMB – Prompt Screen	
Date From	You can select the date by clicking on the calendar. This field is mandatory.
Date To	You can select the end date of the period, for which the report should contain the data by clicking on the calendar.

CMB01 – Journaling of limit utilisations of primary CMB – Prompt Screen	
	For valid report results, the current day cannot be selected. This field is mandatory.
Currency	You can use this drop-down field to select the currency. This field is mandatory.
Party BIC	You can use this drop-down field to select one or several party BIC. This field will show all related BICs, which belong to the default data scope of the user's party. This field is optional.
T2S DCA number	You can use this drop-down field to select one or several T2S DCA numbers. This field will show all related T2S DCAs, which belong to default data scope of the user's party and which belong to the parties selected in field "Party BIC". If no Party BICs are selected, this field shows all T2S DCA numbers belonging to the default data scope of the user's party. This field is optional.

Screenshot

CMB technical identifier		Debit		Credit		Total	
Volume of utilisations	Value used of utilisation	Volume of utilisations	Value used of utilisation	Volume of utilisations	Value used of utilisation	Volume of utilisations	Value used of utilisation
8615	1	0.00				1	0.00
8633	1	0.00				1	0.00
8638	1	0.00				1	0.00
8640	1	0.00				1	0.00
8645	1	0.00				1	0.00
8646	1	0.00				1	0.00
8652	1	0.00				1	0.00
8653	1	0.00				1	0.00
8658	1	0.00	1	15.00		1	15.00
8671	1	0.00				1	0.00
8673	1	0.00				1	0.00
8674	1	0.00				1	0.00
8698	1	0.00				1	0.00
8701	1	0.00				1	0.00
8708	1	0.00				1	0.00
8736	1	0.00				1	0.00
8737	1	0.00				1	0.00
8747	1	0.00				1	0.00
8760	1	0.00				1	0.00

Illustration 355: CMB01 output screen{CR-819}

Field Description

CMB01 – Journaling of limit utilisations of primary CMB – Output Screen	
	The following information is repeated for every CMB matching the selection criteria
CMB technical identifier	The T2S internal identifier of a CMB

CMB01 – Journaling of limit utilisations of primary CMB – Output Screen	
Autocollateralisation limit utilisation : Credit	
Volume of utilisations	Count of the number of credit side utilisations found per CMB technical identifier
Value used of utilisation	Sum over utilised values of credit side utilisations found per CMB technical identifier
Autocollateralisation limit utilisation : Debit	
Volume of utilisations	Count of the number of debit side utilisations found per CMB technical identifier
Value used of utilisation	Sum over utilised values of debit side utilisations found per CMB technical identifier
Total (per CMB technical identifier)	
Volume of utilisations	Sum of 'Volume of utilisations' over credit and debit per CMB technical identifier
Value used of utilisation	Sum of 'Value used of utilisations' over credit and debit per CMB technical identifier
Total (overall)	
Total	Sums of all volumes and values for each column, over all CMB technical identifiers. ⁸⁸

5.5.6 T2S Collateral instructions (COL)

5.5.6.1 COL01 – Follow-up by time slot of settled collateralisation instructions

Context of Usage

This report shows the finalised settled collateralisation instructions at CSD, CSDP, external CSD or securities account level, during a selected period of time. The volume and value of the collateralisation instructions are shown for each time slot of the business day with a total per transaction category (Collateral, Reverse collateral, Relocation) and transaction sub-category (Repo, Pledge, Sub-pledge).

This report can be used by CSD, ~~CSDP and ECSD~~ users. **{CR-819}**

Report Access

This report can be reached in the following way:

- [Content >>](#) Team Content >> [T2S >>](#) Predefined Reports >> [COL - T2S Collateral instructions >>](#) COL01 **{CR-819}**

88 This content is not applicable as of R6.2, and will become applicable upon the deployment of the Data Warehouse for T2S.

Screenshot

COL01 - Securities account - follow-up by time schedule of collateralisation instructions

Date from: * Dec 18, 2023 [calendar icon]

Date to: * Dec 18, 2023 [calendar icon]

Currency: * Currency Code [dropdown]

Party BIC:

Keywords: Input keywords here [search icon]

Select all

No Results

Starts with any of these keywords [dropdown]

Case Insensitive

Party BIC Choices: [empty list] Select all Deselect all

Securities account number:

Keywords: Input keywords here [search icon]

Select all

No Results

Starts with any of these keywords [dropdown]

Case Insensitive

Securities account number Choices: [empty list] Select all Deselect all

ISIN:

Keywords: Input keywords here [search icon]

Select all

No Results

Starts with any of these keywords [dropdown]

Case Insensitive

ISIN Choices: [empty list] Select all Deselect all

Illustration 356: COL01 prompt screen {CR-819}

Field Description

COL01 – Follow-up by time slot of settled collateralisation instructions – Prompt Screen	
Date From	You can select the date by clicking on the calendar. This field is mandatory.

COL01 – Follow-up by time slot of settled collateralisation instructions – Prompt Screen	
Date To	<p>You can select the end date of the period, for which the report should contain the data by clicking on the calendar.</p> <p>For valid report results, the current day cannot be selected.</p> <p>This field is mandatory.</p>
Currency	<p>Currency in which the amount of the collateral instructions must be denominated.</p> <p>This field is mandatory</p>
Party BIC	<p>You can use this drop-down field to select one or several party BIC. This field will show all related BICs, which belong to the default data scope of the user's party.</p> <p>This field is optional.</p>
Securities account number	<p>You can use this drop-down field to select one or several securities account numbers. This field will show all related securities accounts which belong to default data scope of the user's party and which belong to the parties selected in field "Party BIC". If no Party BICs are selected, this field shows all securities account numbers belonging to the default data scope of the user's party.</p> <p>This field is optional.</p>
Securities ISIN{CR-819}	<p>The report output contains only settlement instructions with the selected securities.</p> <p>This field is optional.</p>

Screenshot

The screenshot displays a table titled "COL01 - Follow-up by time schedule of collateralisation instructions". The table is organized into two main sections: "Volume" and "Value". Each section has columns for various transaction categories and their corresponding amounts. The "Volume" section includes columns for "1st NTS cycle", "Last NTS cycle", "R11 before intraday DVP cut-off", "R12 before EOD intraday credit reimbursement", "R13 before EOD intraday FOP cut-off", and "R14 after intraday FOP cut-off". The "Value" section includes columns for "1st NTS cycle", "Last NTS cycle", "R11 before intraday DVP cut-off", "R12 before EOD intraday credit reimbursement", "R13 before EOD intraday FOP cut-off", and "R14 after intraday FOP cut-off". The table lists transaction categories such as COLA, RCOL, and CORE, with sub-categories like REPO, PLED, and SPLE. A "Total" row is provided at the bottom of each section.

Illustration 357: COL01 output screen COL01 – Follow-up by time slot of settled collateralisation instructions [▶ 1119]{CR-819}

Report output is currently not available. It will be changed with the next UHB Version{CR-819}.

Field Description	COL01 – Follow-up by time slot of settled collateralisation instructions – Output Screen	
Transaction category	Shows the transaction category for which the collateralisation instructions are displayed from the possible values:	<input type="checkbox"/> COLA (Collateral) <input type="checkbox"/> RCOL(Reverse collateral) <input type="checkbox"/> CORE (Relocation)
Transaction sub-category	Shows the transaction sub-category for which the collateralisation instructions are displayed from the possible values:	<input type="checkbox"/> REPO (Repo) <input type="checkbox"/> PLED (Pledge) <input type="checkbox"/> SPLE (Sub-pledge)
Volume		
Time slots (one column per time slot):	The aggregated number of finalised settled collateralisation instructions are displayed for each of the time slots within transaction category and sub-category combination.	<input type="checkbox"/> 1st NTS cycle <input type="checkbox"/> Last NTS cycle <input type="checkbox"/> RT1 before intraday DVP cut-off <input type="checkbox"/> RT2 before EOD intraday credit reimbursement <input type="checkbox"/> RT3 before EOD intraday FOP cut-off <input type="checkbox"/> RT4 after intraday FOP cut-off
Volume (Total)	Sum of 'Volume' information over all time-slots within transaction sub-category.	
Value		
Time slots (one column per time slot):	The aggregated amount of finalised settled collateralisation instructions are displayed for each of the above time slots within transaction category and sub-category combination.	<input type="checkbox"/> 1st NTS cycle <input type="checkbox"/> Last NTS cycle

COL01 – Follow-up by time slot of settled collateralisation instructions – Output Screen	
<input type="checkbox"/> RT1 before intraday DVP cut-off	
<input type="checkbox"/> RT2 before EOD intraday credit reimbursement	
<input type="checkbox"/> RT3 before EOD intraday FOP cut-off	
<input type="checkbox"/> RT4 after intraday FOP cut-off	
Value (Total)	Sum of 'Value' information over all time-slots within transaction sub-category.
Totals	
Total (per transaction category)	Sums of each 'Volume' and 'Value' column over all transaction sub-categories within transaction category.
Total (overall)	Sums of each 'Volume' and 'Value' column over all transaction categories. ⁸⁹

5.5.7 Technical instructions (RAL)

5.5.7.1 RAL01 – Detailed realignment and other technical instructions

Context of Usage

This report shows detailed information on volume and quantities for all realignment and other technical settlement instructions (SIs) at CSD, CSDP/ECSD or securities account level, during a selected period of time. The settlement instructions are filtered according the settlement types of the securities that the user selects.

The volumes and quantities (original and the settled) are aggregated per transaction type code, transaction category and transaction sub-category; and displayed by securities movement type and settlement status.

This report can be used by CSD, ~~external CSD (ECSD) and CSD participant (CSDP)~~ users. **{CR-819}**

Report Access

This report can be reached in the following way:

⁸⁹ This content is not applicable as of R6.2, and will become applicable upon the deployment of the Data Warehouse for T2S.

□ [Content >>](#) Team Content >> [T2S >>](#) Predefined Reports >>
[RAL -](#) T2S Technical instructions >> RAL01{CR-819}

Screenshot

Illustration 358: **RAL01 Prompt screen {CR-819}**

Field Description

RAL01 – Detailed realignment and other technical instructions – Prompt screen

Date From You can select the date by clicking on the calendar.

RAL01 – Detailed realignment and other technical instructions – Prompt screen	
	This field is mandatory.
Date To	<p>You can select the end date of the period, for which the report should contain the data by clicking on the calendar.</p> <p>For valid report results, the current day cannot be selected.</p> <p>This field is mandatory.</p>
Settlement type	<p>This selection specifies the quantity type of the settlement for the security, stated in the instruction.</p> <p>Possible values:</p> <ul style="list-style-type: none"> <input type="checkbox"/> Unit <input type="checkbox"/> Nominal. <p>This field is mandatory.</p>
Party BIC	<p>You can use this drop-down field to select one or several party BIC. This field will show all related BICs, which belong to the default data scope of the user's party.</p> <p>This field is optional.</p>
Securities account number	<p>You can use this drop-down field to select one or several securities account numbers. This field will show all related securities accounts which belong to default data scope of the user's party and which belong to the parties selected in field "Party BIC". If no Party BICs are selected, this field shows all securities account numbers belonging to the default data scope of the user's party.</p> <p>This field is optional.</p>
Securities ISIN	<p>The report output contains only settlement instructions with the selected securities.</p> <p>This field is optional.</p>

Screenshot

The screenshot shows the RAL01 report output screen. At the top, there are two tabs: 'RAL01 - Detailed realignment and other technical instructions - volume' (selected) and 'RAL01 - Detailed realignment and other technical instructions - quantity'. Below the tabs is the report title 'RAL01 – Detailed realignment and other technical instructions'. There are filters for 'Settlement type: Under' and 'Date from: 2021-01-18 to: 2023-12-18'. The main content is a table titled 'Detailed realignment and other technical instructions - volume'.

Transaction type code	Transaction category	Transaction sub-category	RECE			Total				
			Totally settled settlement volume	Partially settled/cancelled volume	Totally cancelled settlement volume	Total	Totally settled/cancelled volume	Totally cancelled settlement volume	Total	
FOP	REAL	REAL	16	0	5	21	16	0	5	21
Total			16	0	5	21	16	0	5	21

Illustration 359: RAL01 output screen, tab 1{CR-819}

Transaction type code	Transaction category	Transaction sub-category	RECE				Total		
			Instructed quantity	Quantity totally settled	Quantity partially settled	Quantity partially cancelled	Quantity totally cancelled	Instructed quantity	Settled Quantity
FOP	REAL	REAL	312	228	0	0	84	312	228
Total			312	228	0	0	84	312	228

Illustration 360: RAL01 output screen, tab 2{CR-819}

Field Description

RAL01 – Detailed realignment and other technical instructions – OUTPUT SCREEN Tab 1 - volume	
Transaction type code	Shows the settlement transaction type code set during the selected period duration of time from the possible values: <ul style="list-style-type: none"> <input type="checkbox"/> DVP (delivery versus payment) <input type="checkbox"/> DWP (delivery with payment) <input type="checkbox"/> FOP (free of payment) <input type="checkbox"/> PFOD (payment free of delivery)
Settlement transaction category	Shows the category of the settlement transaction from the possible values: <ul style="list-style-type: none"> <input type="checkbox"/> REAL (realignment) <input type="checkbox"/> COTF (conditional technical FOP)
Settlement transaction sub-category	Shows the subcategory of the settlement transaction from the possible values: <ul style="list-style-type: none"> <input type="checkbox"/> REAL (realignment) <input type="checkbox"/> PLED (pledge) <input type="checkbox"/> REPO (repurchase order) <input type="checkbox"/> COBS (CoSD blocking position setup) <input type="checkbox"/> STND (standard)
DELI	
Volume totally settled	A count of the number of totally settled SIs with security movement type DELI, per transaction type / transaction category and sub-category.
Volume partially settled / partially cancelled	A count of the number of partially settled/partially cancelled SIs with security movement type DELI, per transaction type / transaction category and sub-category.
Volume totally cancelled	A count of the number of totally cancelled matched SIs with security movement type DELI, per transaction type / transaction category and sub-category.

RAL01 – Detailed realignment and other technical instructions – OUTPUT SCREEN Tab 1 - volume	
Total	Sum of 'Volume totally settled', 'Volume partially settled / partially cancelled' and 'Volume totally cancelled' with security movement type DELI, per transaction type / transaction category and sub-category.
RECE	
Volume totally settled	A count of the number of totally settled SIs with security movement type RECE, per transaction type / transaction category and sub-category.
Volume partially settled / partially cancelled	A count of the number of partially settled/partially cancelled SIs with security movement type RECE, per transaction type / transaction category and sub-category.
Volume totally cancelled	A count of the number of totally cancelled matched SIs with security movement type RECE, per transaction type / transaction category and sub-category.
Total	Sum of 'Volume totally settled', 'Volume partially settled / partially cancelled' and 'Volume totally cancelled' with security movement type RECE, per transaction type / transaction category and sub-category.
Total across movement types (per transaction type / transaction category / transaction sub-category)	
Volume totally settled	Sum of 'Volume totally settled' over all DELI and RECE security movement types, per transaction type / transaction category and sub-category.
Volume partially settled / partially cancelled	Sum of 'Volume partially settled / partially cancelled' over all DELI and RECE security movement types, per transaction type / transaction category and sub-category.
Volume totally cancelled	Sum of 'Volume totally cancelled' over all DELI and RECE security movement types, per transaction type / transaction category and sub-category.
Total	Sum of the 'Total' over all DELI and RECE security movement types, per transaction type / transaction category and sub-category.
Total	
Total	Sum of the volumes over all transaction type codes, for each column of the report as above.

RAL01 – Detailed realignment and other technical instructions – OUTPUT SCREEN Tab 2 - quantity	
Transaction type code	Shows the settlement transaction type code set during the selected period duration of time from the possible values: <ul style="list-style-type: none"> <input type="checkbox"/> DVP (delivery versus payment) <input type="checkbox"/> DWP (delivery with payment) <input type="checkbox"/> FOP (free of payment) <input type="checkbox"/> PFOD (payment free of delivery)
Settlement transaction category	Shows the category of the settlement transaction from the possible values: <ul style="list-style-type: none"> <input type="checkbox"/> REAL (realignment) <input type="checkbox"/> COTF (conditional technical FOP)
Settlement transaction sub-category	Shows the subcategory of the settlement transaction from the possible values: <ul style="list-style-type: none"> <input type="checkbox"/> REAL (realignment) <input type="checkbox"/> PLED (pledge) <input type="checkbox"/> REPO (repurchase order) <input type="checkbox"/> COBS (CoSD blocking position setup) <input type="checkbox"/> STND (standard)
DELI	
Original Instructed quantity	Sum of original instructed settlement quantity of all totally and partially settled SIs with securities movement type DELI, per transaction type / transaction category and sub-category. {CR-819}
Quantity totally settled	Sum of settled settlement quantity of all totally settled SIs with securities movement type DELI, per transaction type / transaction category and sub-category.
Quantity partially settled	Sum of settled settlement quantity of all partially settled SIs with securities movement type DELI, per transaction type / transaction category and sub-category.
Quantity partially cancelled	Sum of unsettled amount of all partially settled SIs with securities movement type DELI, per transaction type / transaction category and sub-category.
Quantity totally cancelled	Sum of unsettled amount of all totally cancelled SIs with securities movement type DELI, per transaction type / transaction category and sub-category.

RAL01 – Detailed realignment and other technical instructions – OUTPUT SCREEN Tab 2 - quantity	
RECE	
Original Instructed quantity	Sum of original instructed settlement quantity of all totally and partially settled SIs with securities movement type RECE, per transaction type / transaction category and sub-category. {CR-819}
Quantity totally settled	Sum of settled settlement quantity of all totally settled SIs with securities movement type RECE, per transaction type / transaction category and sub-category.
Quantity partially settled	Sum of settled settlement quantity of all partially settled SIs with securities movement type RECE, per transaction type / transaction category and sub-category.
Quantity partially cancelled	Sum of unsettled amount of all partially settled SIs with securities movement type RECE, per transaction type / transaction category and sub-category.
Quantity totally cancelled	Sum of unsettled amount of all totally cancelled SIs with securities movement type RECE, per transaction type / transaction category and sub-category.
Total across movement types (per transaction type / transaction category / transaction sub-category)	
Original quantity	Sum of 'Original quantity' for 'DELI' and 'RECE' per transaction type / transaction category and sub-category.
Quantity settled (totally settled + partially settled)	Sum of 'Quantity totally settled' plus 'Quantity Partially settled' for 'DELI' and 'RECE' per transaction type / transaction category and sub-category.
Total	
Total	Sum of the quantities over all transaction type codes, for each column of the report as above. ⁹⁰

90 This content is not applicable as of R6.2, and will become applicable upon the deployment of the Data Warehouse for T2S.

Index

B

Buttons	43
Button bar	35
First	48
Information panel	34
Last	48
Next	48
Previous	48
T2S logo	34

C

Characters	
SWIFT-x character set	40
UTF-8 character set	40

E

Error message	50
---------------	----

F

Field types	
Check boxes	39
Input fields	37
Input-sensitive fields	37
Radio buttons	39
Select fields	37
Four-eyes mode	49
Frame	35

G

Graphical user interface	26
Content area	34
Header	33
Menu bar	32
Page layout	26
Screen layout	33
Structure	32

I

Icons	43
Add row	46
Alert	52
Auto-complete select box	47
Back	35, 43
Calendar	46
Collapse	45
Export	35, 44
Magnifier	47
Print	35, 43
Refresh	35, 44
Sort	48
Information signs	
Example sign	27
Notice sign	27

O

Online help	54
-------------	----

S

Screen reference part	30
Screen types	
Details screen	37
Enter screen	37
Search/List screen	36
Welcome screen	36
Screenshot	28
Sub-frame	35
Success message	50

U

UHB methodology	26
UHB structure	29
User administration	
Registration	54
User instructions part	30

V

Validation

Back-end validation	49
Confirmation prompt	49
Cross-field validation	49
Field validation	49
Front-end validation	49

W

Wildcard	41
----------	----

6 Annex

6.1 Indication of Usage

6.1.1 Reader's Guide

Reader's Guide

This part of the annex is divided into screens and business scenarios, both in alphabetical order. For each screen description and business scenario, you can find an indication of the primary user (CB / CSD). This indication is not binding.

6.1.2 Usage Indication

Screens

Screen	Usage Indication (CSD/ CB)
Allegation Instruction - Details Screen [▶ 94]	CSD
Allegation Instructions - Search/List Screen [▶ 90]	CSD
Amendment Cash Instruction - Details Screen [▶ 405]	CB
Amendment Cash Instruction - New Screen [▶ 410]	CB
Amendment Securities Instruction - Details Screen [▶ 98]	CSD
Amendment Securities Instruction - New Screen [▶ 103]	CSD
Attribute Domain - Details Screen	CSD/CB
Attribute Domain - New/Edit Screen	CSD/CB
Attribute Domain Reference - Details Screen	CSD/CB
Attribute Domain Reference - New/Edit Screen	CSD/CB
Attribute Domain References - List Screen	CSD/CB
Attribute Domains - Search/List Screen	CSD/CB
Auto-Collateralisation Eligibility Link - New Screen	CB
Auto-Collateralisation Eligibility Links - Search/List Screen	CB
Available Report - Current Settlement Day Cash Information (Following Settlement Day Cash Forecast) Report - Details Screen [▶ 459]	CB
Available Report – Daily Penalty List – Details Screen [▶ 574]	CSD
Available Report - Details Screen [▶ 457]	CSD/CB

Screen	Usage Indication (CSD/ CB)
Available Report – List of Modified Penalties - Details Screen [▶ 588]	CSD
Available Report – Monthly Aggregated Amounts – Details Screen [▶ 603]	CSD
Available Report - Statement of Accounts - Details Screen [▶ 464]	CB
Available Report - Statement of Executed Amendment Instructions for Intra-Balance Movements - Details Screen [▶ 467]	CB
Available Report - Statement of Executed Amendment Instructions for Intra-Position Movements and Settlement Instructions - Details Screen [▶ 472]	CSD
Available Report - Statement of Executed Cancellation Instructions for Intra-Balance Movements - Details Screen [▶ 481]	CB
Available Report - Statement of Executed Cancellation Instructions for Intra-Position Movements and Settlement Instructions - Details Screen [▶ 485]	CSD
Available Report - Statement of Holdings - Details Screen [▶ 493]	CSD
Available Report - Statement of Pending Amendment Instructions for Intra-Balance Movements - Details Screen [▶ 498]	CB
Available Report - Statement of Pending Amendment Instructions for Intra-Position Movements and Settlement Instructions - Details Screen [▶ 503]	CSD
Available Report - Statement of Pending Cancellation Instructions for Intra-Balance Movements - Details Screen [▶ 512]	CB
Available Report - Statement of Pending Cancellation Instructions for Intra-Position Movements and Settlement Instructions - Details Screen [▶ 516]	CSD
Available Report - Statement of Pending Instructions - Details Screen [▶ 524]	CSD
Available Report - Statement of Pending Intra-Balance Movements - Details Screen [▶ 533]	CB

Screen	Usage Indication (CSD/ CB)
Available Report - Statement of Pending Intra-Position Movements - Details Screen [▶ 538]	CSD
Available Report - Statement of Settled Intra-Balance Movements - Details Screen [▶ 543]	CB
Available Report - Statement of Settled Intra-Position Movements - Details Screen [▶ 548]	CSD
Available Report - Statement of Settlement Allegements - Details Screen [▶ 551]	CSD
Available Report - Statement of Transactions - Details Screen [▶ 564]	CSD
Available Reports - Statement of Common Reference Data details Screen	CSD/CB
Available Reports – Details Screen	CSD/CB
Available Reports - Search/List Screen [▶ 452]	CSD/CB
BIC Directory Items - Search/List Screen	CSD/CB
Broadcast - Details Screen [▶ 620]	CSD/CB
Broadcast - New Screen [▶ 622]	CSD/CB
Broadcasts – Search/List Screen [▶ 617]	CSD/CB
Calendar – Details Screen	CSD/CB {Split book approach}
Cancellation Cash Instruction – Details Screen [▶ 417]	CB
Cancellation Cash Instruction – New Screen [▶ 420]	CB
Cancellation Securities Instruction – Details Screen [▶ 113]	CSD
Cancellation Securities Instruction – New Screen [▶ 117]	CSD
Cash Account - Details Screen	CSD/CB
Cash Account – New/Edit Screen	CSD/CB
Cash Accounts - Search/List Screen	CSD/CB
Cash Discount Penalty Rate - Search/List Screen	CSD/CB
Cash Forecast – Details Screen [▶ 332]	CB
Cash Forecasts – Search/List Screen [▶ 324]	CB

Screen	Usage Indication (CSD/ CB)
Cash Restriction Details – Search/List Screen [▶ 338]	CB
Certificate Distinguished Name – New Screen	CSD/CB
Certificate Distinguished Names – Search/List Screen	CSD/CB
Close Link – New Screen	CB
Close Links – Search/List Screen	CSD/CB
Closing Days- Search/List Screen	CSD/CB
Collateral Value of a Security – Search/List Screen [▶ 341]	CSD/CB
Collateral Value per T2S Dedicated Cash Account and Security – Search/List Screen [▶ 345]	CSD/CB
Common Reference Data Revisions - Search/List Screen	CSD/CB
CoSD Rule – New/Edit Screen	CSD
CoSD Rule Sets - Details Screen	CSD
CoSD Rule Sets – New/Edit Screen	CB
CoSD Rule Sets - Search/List Screen	CSD
Countries - Search/List Screen	CSD/CB
CMB - Details Screen	CB
CMB - New/Edit Screen	CB
CMBs - Search/List Screen	CB
CSD Account Link - New/Edit Screen	CSD
CSD Account Links - Search/List Screen	CSD
Currencies - Search/List Screen	CSD/CB
Daily Price – New/Edit Screen	CSD
Daily Price - Search/List Screen	CSD/CB
Data Change - Details Screen [▶ 612]	CSD/CB
Data Changes - Search/List Screen [▶ 608]	CSD/CB
Eligible Counterpart CSD - Details Screen	CSD
Eligible Counterpart CSD - New/Edit Screen	CSD
Eligible Counterpart CSDs - Search/List Screen	CSD

Screen	Usage Indication (CSD/ CB)
Euro Foreign Exchange Reference Rate - New/Edit Screen	CB
Euro Foreign Exchange Reference Rate - Search/List Screen	CSD/CB
Event Type - Details Screen	CSD/CB
Event Types - Search/List Screen	CSD/CB
External RTGS Account - Details Screen	CB
External RTGS Account - New/Edit Screen	CB
External RTGS Accounts - Search/List Screen	CB
Grant/Revoke Cross-System Entity Object Privilege – Details Screen	CSD/CB
Grant/Revoke Cross-System Entity Object Privilege – New/Edit Screen	CSD/CB
Grant/Revoke Object Privilege – Details Screen	CSD/CB
Grant/Revoke Object Privilege – New/Edit Screen	CSD/CB
Grant/Revoke Privileges – Search/List Screen	CSD/CB
Grant/Revoke Roles – Details Screen	CSD/CB
Grant/Revoke Roles – New/Edit Screen	CSD/CB
Grant/Revoke Roles - Search/List Screen	CSD/CB
Grant/Revoke System Privilege – Details Screen	CSD/CB
Grant/Revoke System Privilege – New/Edit Screen	CSD/CB
Hold/Release Instruction – Details Screen [▶ 122]	CSD
Hold/Release Instruction – New Screen [▶ 126]	CSD
Immediate Liquidity Transfer – Details Screen [▶ 382]	CB
Immediate Liquidity Transfer – New Screen [▶ 387]	CB
Immediate Liquidity Transfer – Search/List Screen [▶ 374]	CB
Inbound File – Details Screen [▶ 626]	CSD/CB
Inbound Files – Search/List Screen [▶ 623]	CSD/CB
Inbound Message – Details Screen [▶ 636]	CSD/CB
Inbound Messages – Search/List Screen [▶ 629]	CSD/CB

Screen	Usage Indication (CSD/ CB)
Insolvency procedure Settlement Instructions – Search/List Screen [▶ 270]	CSD
Intra-Balance Movement – Details Screen [▶ 430]	CB
Intra-Balance Movement – New Screen [▶ 437]	CB
Intra-Balance Movements – Search/List Screen [▶ 423]	CB
Intra-Position Movement – Details Screen [▶ 144]	CSD
Intra-Position Movement – New Screen [▶ 151]	CSD
Intra-Position Movements – Search/List Screen [▶ 137]	CSD
Invoice Data – Details Screen	CSD/CB
Invoice Data – New Screen	CSD/CB
Invoice Data – Search/List Screen	CSD/CB (Split book approach)
Limit – New/Edit Screen [▶ 348]	CB
Limit Utilisation – Search/List Screen [▶ 349]	CSD/CB
Limit Utilisation Journal – Search/List Screen [▶ 353]	CSD/CB
Limits – Search/List Screen [▶ 348]	CB
Links Preventing Settlement - List Screen [▶ 277]	
Maintenance Cash Instructions – Search/List Screen [▶ 448]	CB
Maintenance Securities Instructions – Search/List Screen [▶ 164]	CSD
Manual Correction – Details Screen	
Manual Correction – New/Edit Screen	CB
Manual Corrections – Search/List Screen	CB
Market-Specific Attribute – Details Screen	CSD/CB
Market-Specific Attribute – New/Edit Screen	CSD/CB
Market-Specific Attributes – Search/List Screen	CSD/CB
Message Subscription Rule – New/Edit Screen	CSD/CB
Message Subscription Rule Set – Details Screen	CSD/CB
Message Subscription Rule Set – New/Edit Screen	CSD/CB

Screen	Usage Indication (CSD/CB)
Message Subscription Rule Sets – Search/List Screen	CSD/CB
Monthly Net Penalty Amounts - Search/List Screen [▶ 310]	CSD
Network Services – Search/List Screen	CSD/CB
Outbound File – Details Screen [▶ 644]	CSD/CB
Outbound Files – Search/List Screen [▶ 641]	CSD/CB
Outbound Message – Details Screen [▶ 654]	CSD/CB
Outbound Message – Details Screen	CSD/CB
Outbound Messages – Search/List Screen	CSD/CB {Split book approach}
Outstanding Auto-Collateralisation Credits – Search/List Screen [▶ 393]	CSD/CB
Overall Liquidity – Search/List Screen [▶ 397]	CB
Partial Settlement Thresholds – Search/List Screen	CSD/CB
Parties – Search/List Screen	CSD/CB
Party – Details Screen	CSD/CB
Party – New/Edit Screen	CSD/CB
PDF Invoice – Search/List Screen	CB/CSD
Penalty - Details Screen [▶ 291]	CSD
Penalty - Removal Screen [▶ 315]	CSD
Penalty - Search/List Screen [▶ 279]	CSD
Penalty - Switch Screen [▶ 322]	CSD
Privileges – Search/List Screen	CSD/CB
Queued Static Data Changes – Search/List Screen	CSD/CB
Queued Static Data Change – Details Screen	CSD/CB
Report Configurations - Details Screen	CSD/CB
Report Configuration – New/Edit Screen	CSD/CB
Report Configurations – Search/List Screen	CSD/CB
Resend Communication Screen [▶ 658]	CSD/CB
Restricted Parties – Search/List Screen	CSD/CB
Restriction Type - Details Screen	CSD/CB

Screen	Usage Indication (CSD/ CB)
Restriction Type – New/Edit Screen	CSD/CB
Restriction Type Rule – New/Edit Screen	CSD/CB
Restriction Types – Search/List Screen	CSD/CB
Revisions/Audit Trail – Details Screen	CSD/CB
Revisions/Audit Trail – List Screen	CSD/CB
Role – New/Edit Screen	CSD/CB
Roles – Search/List Screen	CSD/CB
Routing – New/Edit Screen	CSD/CB
Routing – Search/List Screen	CSD/CB
Secured Group – Details Screen	CSD/CB
Secured Group – New/Edit Screen	CSD/CB
Secured Groups – Search/List Screen	CSD/CB
Securities – Search/List Screen	CSD/CB
Securities Account – Details Screen	CSD
Securities Account – New/Edit Screen	CSD
Securities Account Transfer Management – Edit Screen	CSD
Securities Accounts – Search/List Screen	CSD
Securities Accounts Links – New/Edit Screen	CSD
Securities Accounts Links – Search/List Screen	CSD/CB
Securities Position – Details Screen [▶ 174]	CSD
Securities Positions – Search/List Screen [▶ 169]	CSD
Securities Postings – Search/List Screen [▶ 82]	CSD
Securities Restriction Details – Search/List Screen [▶ 86]	CSD
Securities subject to Cash Penalties – New/Edit Screen	CSD
Securities Subject to Cash Penalties - Search/List Screen	CSD/CB
Securities Valuation – New Screen	CB
Securities Valuations – Search/List Screen	CB
Security – Details Screen	CSD/CB
Security – New/Edit Screen	CSD

Screen	Usage Indication (CSD/ CB)
Security CSD Link – Details Screen	CSD
Security CSD Link – New/Edit Screen	CSD
Security CSD Links – Search/List Screen	CSD
Security Penalty Rate - Search/List Screen	CSD/CB
Service Item – Details Screen	CSD/CB
Service Items – Search/List Screen	CSD/CB
Settlement Days – Search/List Screen	CSD/CB {Split book approach}
Settlement Instruction – Details Screen [▶ 192]	CSD
Settlement Instruction – New Screen [▶ 211]	CSD
Settlement Instructions – Search/List Screen [▶ 177]	CSD
SME Growth Market - Search/List Screen	CSD/CB
Standing/Predefined Liquidity Transfer Order – Details Screen [▶ 401]	CB
Standing/Predefined Liquidity Transfer Order – New/Edit Screen [▶ 401]	CB
Standing/Predefined Liquidity Transfer Order Link Set – Details Screen [▶ 401]	CB
Standing/Predefined Liquidity Transfer Order Link Set – New/Edit Screen [▶ 401]	CB
Standing/Predefined Liquidity Transfer Order Link Sets – Search/List Screen [▶ 401]	CB
Standing/Predefined Liquidity Transfer Orders – Search/List Screen [▶ 401]	CB
Status History – Details Screen [▶ 267]	CSD/CB
System Entities – Search/List Screen	CSD/CB
T2S DCA Balance - Details Screen [▶ 362]	CB
T2S DCA Balances - Search/List Screen [▶ 358]	CB
T2S DCA Postings - Search/List Screen [▶ 364]	CB
Technical Addresses Network Services Link - Details Screen	CSD/CB
Technical Addresses Network Services Link - New/Edit Screen	CSD/CB

Screen	Usage Indication (CSD/ CB)
Tolerance Amounts - Search/List Screen	CSD/CB
Total Amount of Standing/Predefined Liquidity Transfer Orders - Search/List Screen [▶ 401]	CB
Total collateral value per T2S dedicated cash account - Search/List Screen [▶ 370]	CSD/CB
User - Details Screen	CSD/CB
User – New/Edit Screen	CSD/CB
User- Search/List Screen	CSD/CB
User Access Rights - List Screen	CSD/CB
User Access Rights - Search Screen	CSD/CB
User Certificate Distinguished Name Link - New Screen	CSD/CB
User Certificate Distinguished Name Links - Search/ List Screen	CSD/CB

Business Scenarios

Business Scenario	Usage Indication (CSD/ CB)
Add a Link for a Settlement Instruction [▶ 744]	CSD
Add a Link for a Settlement Restriction on Cash [▶ 807]	CB
Add a Link for a Settlement Restriction on Securities [▶ 798]	CSD
Add a new Technical Address to a Party	CSD/CB
Amend the Partial Settlement Indicator for a Settlement Instruction [▶ 747]	CSD
Amend the Priority for a Settlement Instruction [▶ 748]	CSD
Amend the Priority for a Settlement Restriction on Cash [▶ 809]	CB
Amend the Priority for a Settlement Restriction on Securities [▶ 801]	CSD
Approve an Action in 4-Eyes Mode	CSD/CB
Assign a Role to a Party	CSD/CB
Assign a Role to a User	CSD/CB
Assign a Secured Object to a Secured Group	CSD/CB

Business Scenario	Usage Indication (CSD/ CB)
Cancel a Settlement Instruction [▶ 768]	CSD
Cancel a Settlement Restriction on Cash [▶ 818]	CB
Cancel a Settlement Restriction on Securities [▶ 814]	CSD
Change the Limit of a Payment Bank	CB
Configure CSD Account Links	CSD
Configure Security CSD Links	CSD
Copy a Settlement Instruction [▶ 731]	CSD
Copy a Settlement Restriction on Cash [▶ 794]	CB
Copy a Settlement Restriction on Securities [▶ 788]	CSD
Copy an Immediate Liquidity Transfer [▶ 712]	CB/CSD
Create a new Broadcast	CSD/CB
Create a new Credit Memorandum Balance	CB
Create a new external RTGS Account	CB
Create a new Immediate Liquidity Transfer	CSD/CB
Create a new Liquidity Transfer Order Link Set	CB
Create a new Participant	CSD/CB
Create a new Report Configuration	CSD/CB
Create a new Role	CSD/CB
Create a new Secured Group	CSD/CB
Create a new Securities Account	CSD
Create a new Securities Valuation	CB
Create a new Security	CSD
Create a new Standing/Predefined Liquidity Transfer Order	CB
Create a new T2S Dedicated Cash Account	CB
Create a new Technical Address Service Link	CSD/CB
Create a new User	CSD/CB
Create a new User Certificate Distinguished Name	CSD/CB
Create a new User Certificate Distinguished Name Link	CSD/CB
Delete an existing Participant	CSD/CB

Business Scenario	Usage Indication (CSD/ CB)
Delete an existing Securities Account	CSD
Delete an existing T2S Dedicated Cash Account	CB
Edit an existing Participant	CSD/CB
Edit an existing Securities Account	CSD
Edit an existing T2S Dedicated Cash Account	CB
Enter a Settlement Instruction [▶ 727]	CSD
Enter a Settlement Restriction on Cash [▶ 792]	CB
Enter a Settlement Restriction on Securities [▶ 786]	CSD
Grant a Privilege to a Party	CSD/CB
Grant a Privilege to a User	CSD/CB
Grant System and Object Privileges to a Role	CSD/CB
Initiate an Action in 4-Eyes Mode	CSD/CB
Link a Securities Account to a T2S Dedicated Cash Account for Cash Settlement Purpose	CSD
Put a Settlement Instruction on CSD Hold [▶ 756]	CSD
Put a Settlement Instruction on Party Hold [▶ 754]	CSD
Reimburse an Outstanding Intraday Credit [▶ 720]	CSD
Release a Settlement Instruction from CoSD Hold [▶ 763]	CSD
Release a Settlement Instruction from CSD Hold [▶ 761]	CSD
Release a Settlement Instruction from CSD Validation Hold [▶ 765]	CSD
Release a Settlement Instruction from Party Hold [▶ 758]	CSD
Remove a Link for a Settlement Instruction [▶ 750]	CSD
Remove a Link for a Settlement Restriction on Cash [▶ 811]	CB
Remove a Link for a Settlement Restriction on Securities [▶ 803]	CSD
Resend Communication [▶ 708]	CSD/CB
Respond to an Allegement Instruction [▶ 737]	CSD
Set up an Auto-Collateralisation Limit	CB

Business Scenario	Usage Indication (CSD/ CB)
View a Broadcast [▶ 707]	CSD/CB
View Alleged Cancellation Instruction [▶ 771]	CSD
View Allegement Settlement Instruction Details [▶ 743]	CSD
View Amendment Instruction for a Settlement Instruction Details [▶ 752]	CSD
View Amendment Instruction for a Settlement Restriction on Cash Details [▶ 813]	CB
View Amendment Instruction for a Settlement Restriction on Securities Details [▶ 805]	CSD
View Available Reports	CSD/CB
View Cancellation Instruction for a Settlement Instruction Details [▶ 770]	CSD
View Cancellation Instruction for a Settlement Restriction on Cash Details [▶ 819]	CB
View Cancellation Instruction for a Settlement Restriction on Securities Details [▶ 816]	CSD
View Cash Balances Details and Related Postings [▶ 714]	CB
View Cash Balances Details and Related Restrictions [▶ 715]	CB
View Current Securities Positions and Related Posting [▶ 722]s	CSD
View Current Securities Positions and Related Restrictions [▶ 723]	CSD
View Historic Securities Positions for a Specific Date [▶ 724]	CSD
View Historic Securities Positions for a Specific Period [▶ 725]	CSD
View Hold/Release Instruction Details [▶ 766]	CSD
View Immediate Liquidity Transfer Details [▶ 716]	CSD/CB
View Inbound Communication [▶ 709]	CSD/CB
View Outbound Communication [▶ 710]	CSD/CB
View Overall Liquidity [▶ 718]	CSD/CB

Business Scenario	Usage Indication (CSD/CB)
View Privilege Details	CSD/CB
View Revisions	CSD/CB
View Settlement Instruction Details [▶ 742]	CSD
View Settlement Instruction Status History [▶ 773]	CSD
View Settlement Restriction on Cash Details [▶ 797]	CB
View Settlement Restriction on Securities Details [▶ 791]	CSD
View SF1/SF2 timestamps of Settlement Instructions in case of Insolvency situation [▶ 774]	CB
View Standing/Predefined Liquidity Transfer Order Details	CSD/CB

6.2 Sitemap for T2S GUI

6.2.1 Reader's Guide

The sitemap annex is structured along the first and the second GUI menu level. It provides you with a formalised illustration of all screens (pictured as rectangles) and their related buttons (pictured as arrows). The illustration helps you to get an overview of all GUI screens and their interrelation, indicated by the arrows.

General layout of a sitemap

In general, each sitemap has the same layout. The header of the sitemap always indicates the GUI menu item pictured by the sitemap. The first 3 lines represent the 3 main menu levels.

Menu Name	
Menu Level 1	
Menu Level 2	
Menu Level 3	

Illustration 361: Sitemap menu levels – GUI path

In lines 4 to 6, the single GUI screens are pictured following their business logic, i.e. starting with *search/list* screens in line 4, *details* or *enter* screens in line 5 and finishing with *revisions/audit trail – list* screens in line 6.

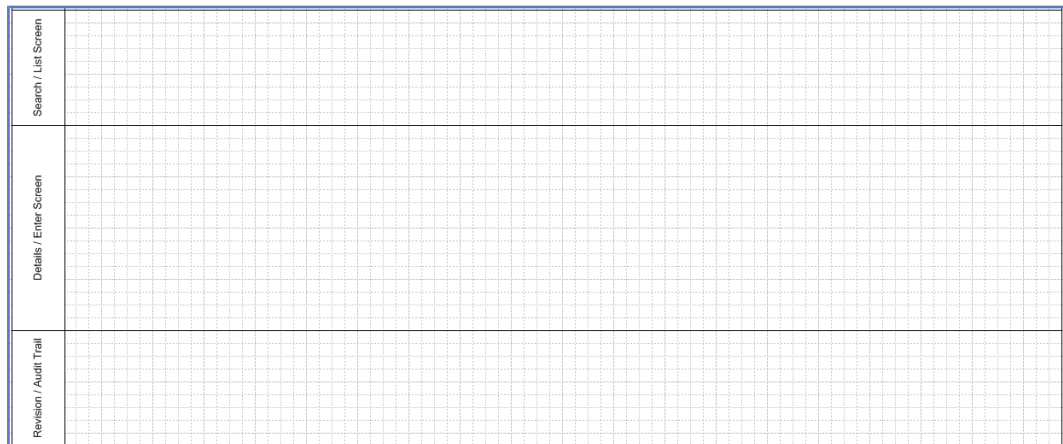

Illustration 362: Sitemap menu levels - screens

Within these lines, regular rectangles represent a menu item, rounded rectangles represent a screen.

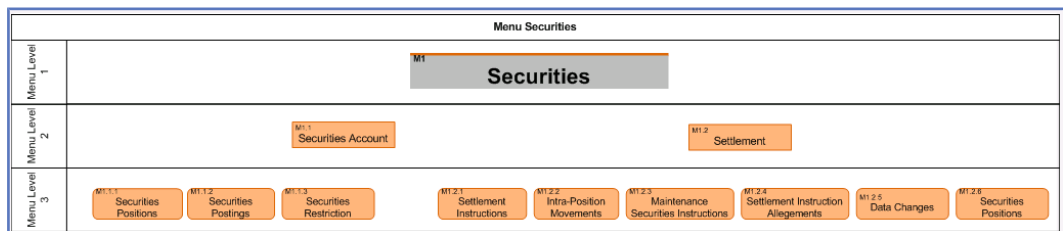

Illustration 363: Menu item and sitemap screen illustration

Interrelation between screens

Arrows between the rectangles represent an interrelation, while the button that has to be clicked on to jump from one screen to another is written across the corresponding arrow.

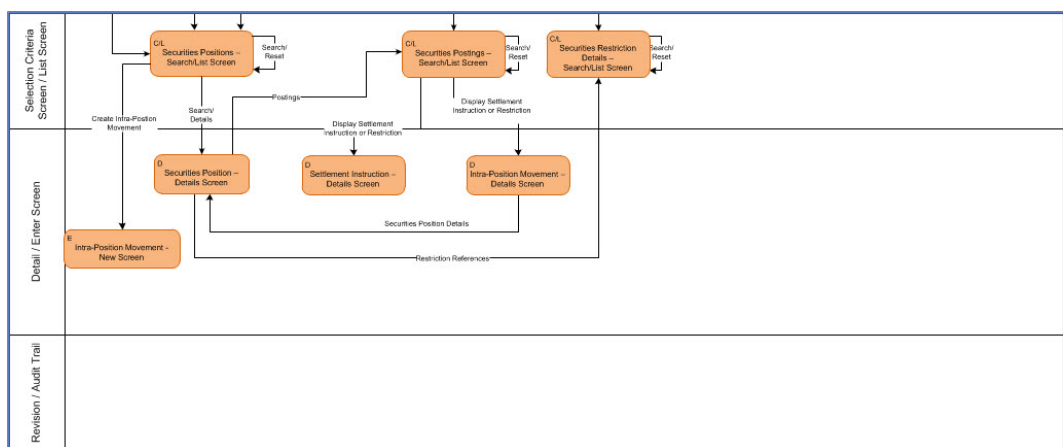

Illustration 364: Screen interrelation

Menu item and screen rectangles

The screen rectangles follow the same colour-coding as the GUI (see menu structure [▶ 32]). The classification found in the top left corner of each rectangle provides the following detailed information:

- Capital M for menu followed by max. 3 digits indicating the main menu item (1 for securities, 2 for cash, 3 for services, 4 for static data, 5 for monitoring) and following menu levels.

- Screen classification (C/L for search/list screen, C for search screen, L for list screen, D for details screen, E for enter screen).

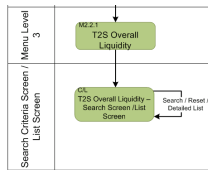

Illustration 365: Sitemap screen with classification and with button

Screens with a different colour

On some sitemaps you will also find screens illustrated in a different colour than it is foreseen for the respective T2S menu. These particular screens represent an alternative navigation to the same respective screen. These specific screens appear on the same menu level than the regular screens.

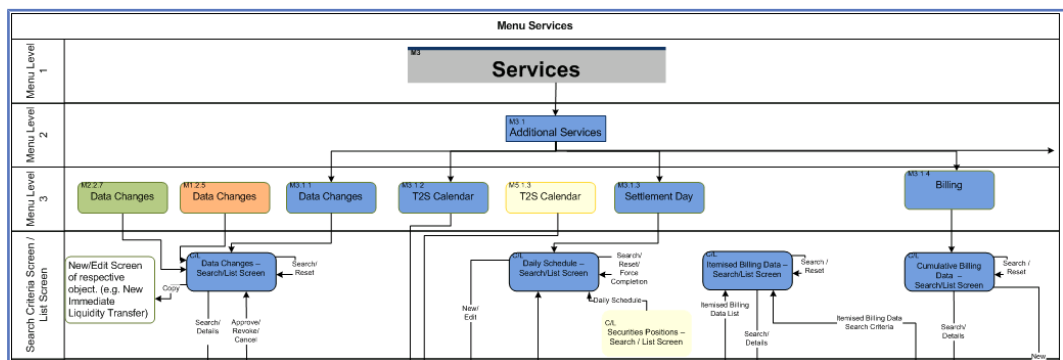

Illustration 366: Screens with a different colour

Interrelation between sitemap parts

Because of the size of the sitemap it has been split into several parts. You can recognise the use of several sitemap parts by an arrow leading to the next sitemap part.

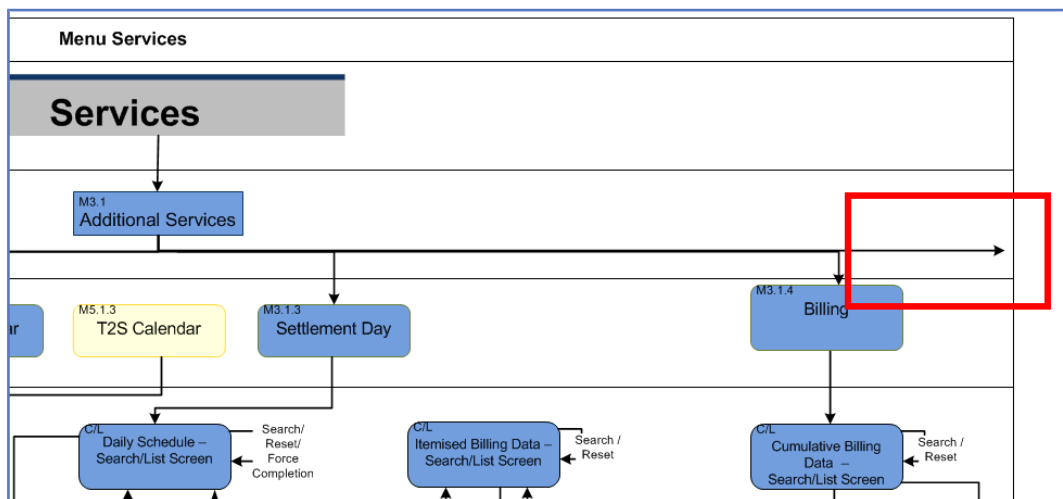

Illustration 367: Sitemap part interrelation

The static data sitemap for example is divided into 14 different sitemaps because of the wealth of information. Therefore it is recommended to read the sitemap from the top to the bottom and then from the left hand-side to the right hand-side.

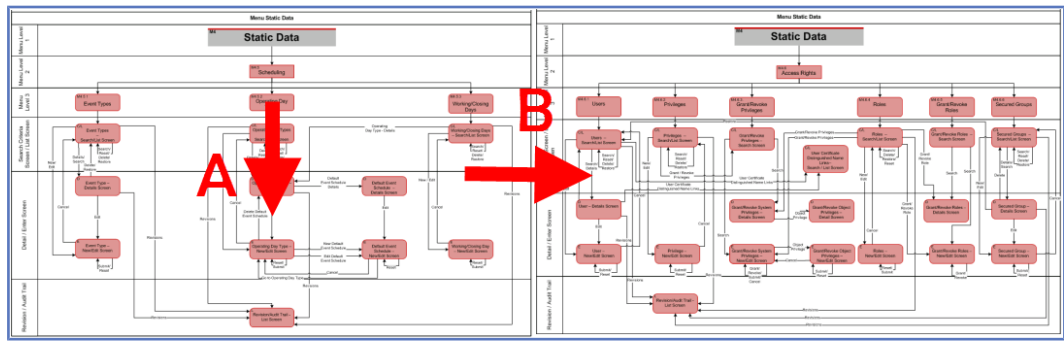
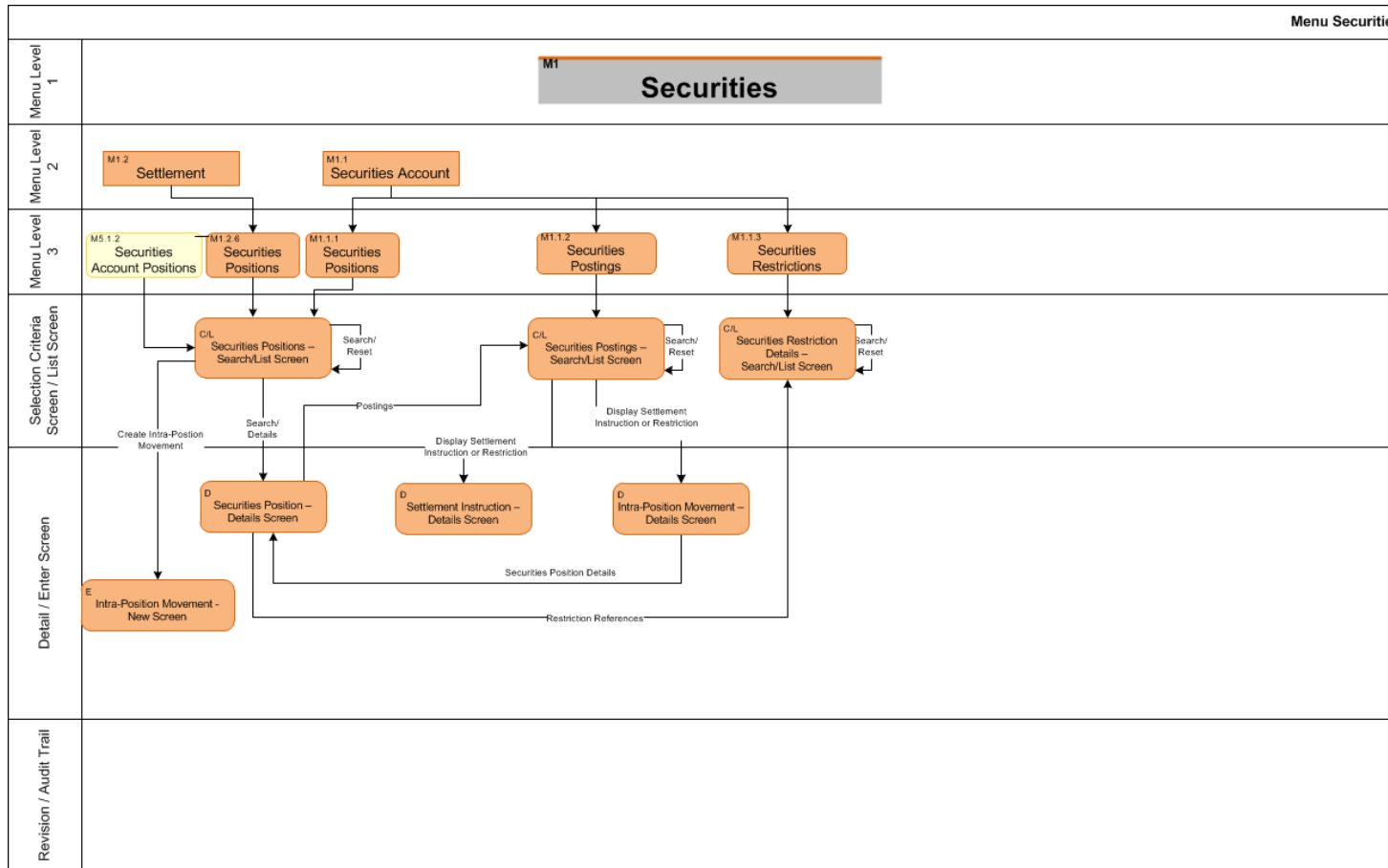

Illustration 368: How to read a sitemap

6.2.2 Securities

6.2.2.1 Securities Account



6.2.2.2 Settlement

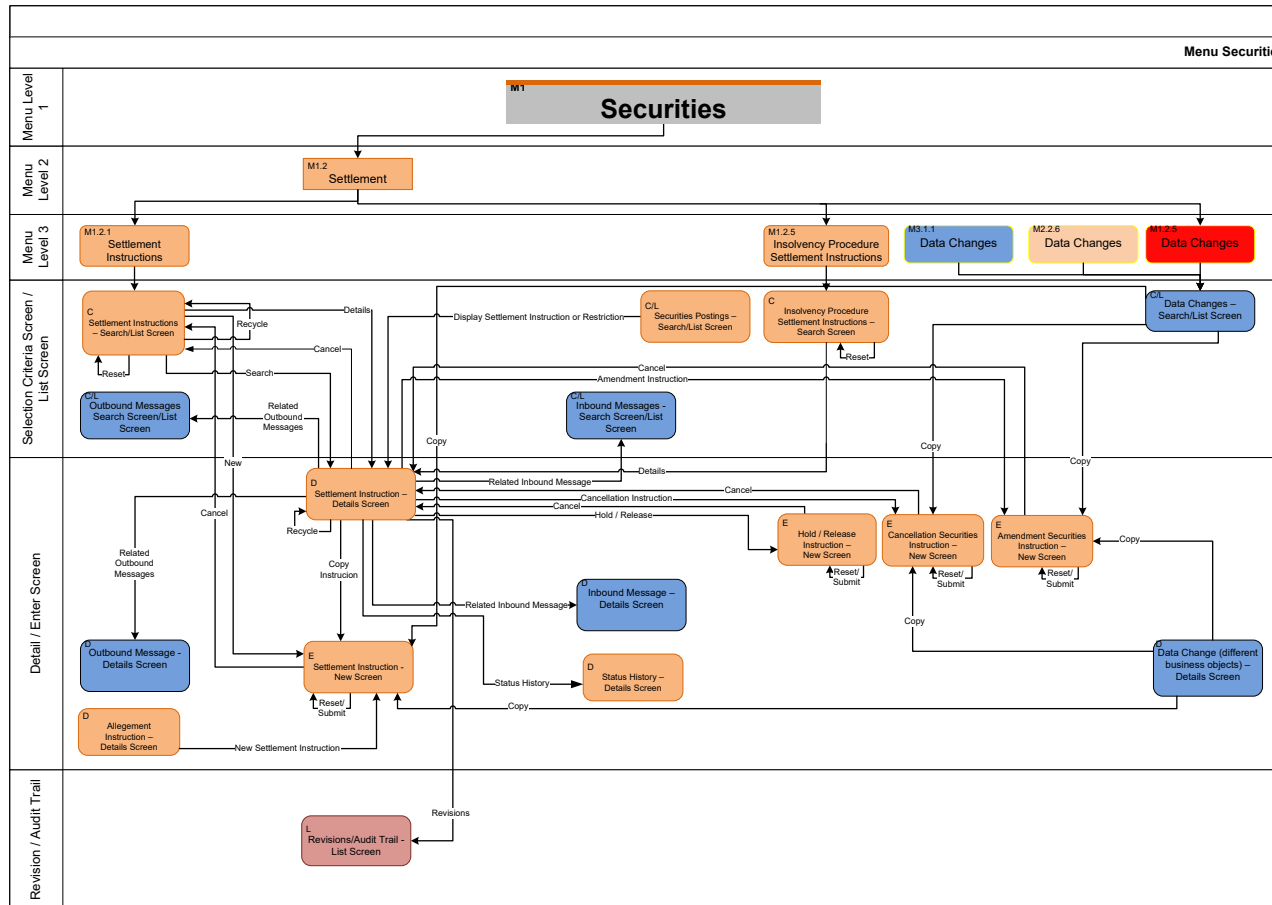

6.2.2.3 Settlement II

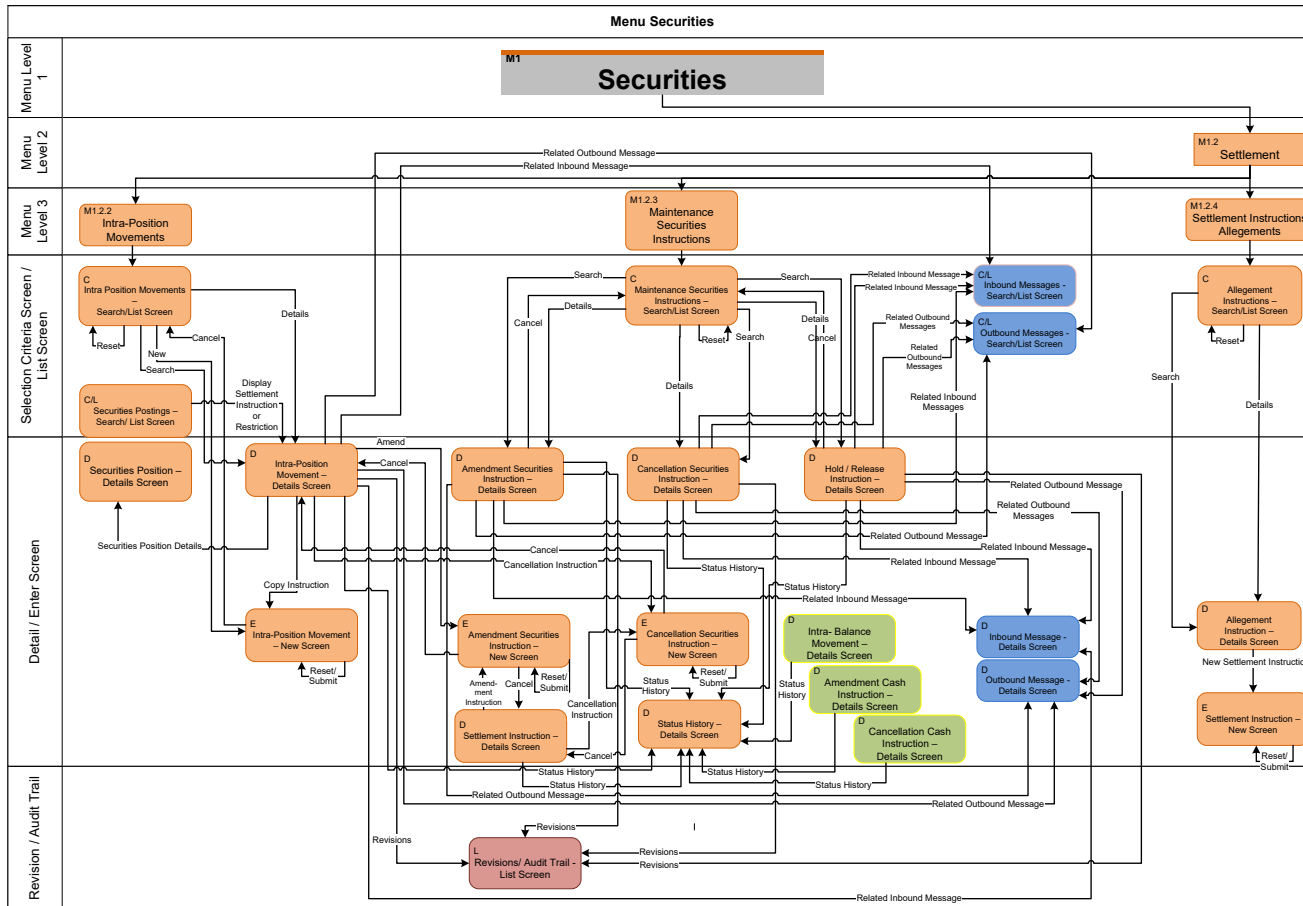

6.2.3 Cash

6.2.3.1 Cash Account

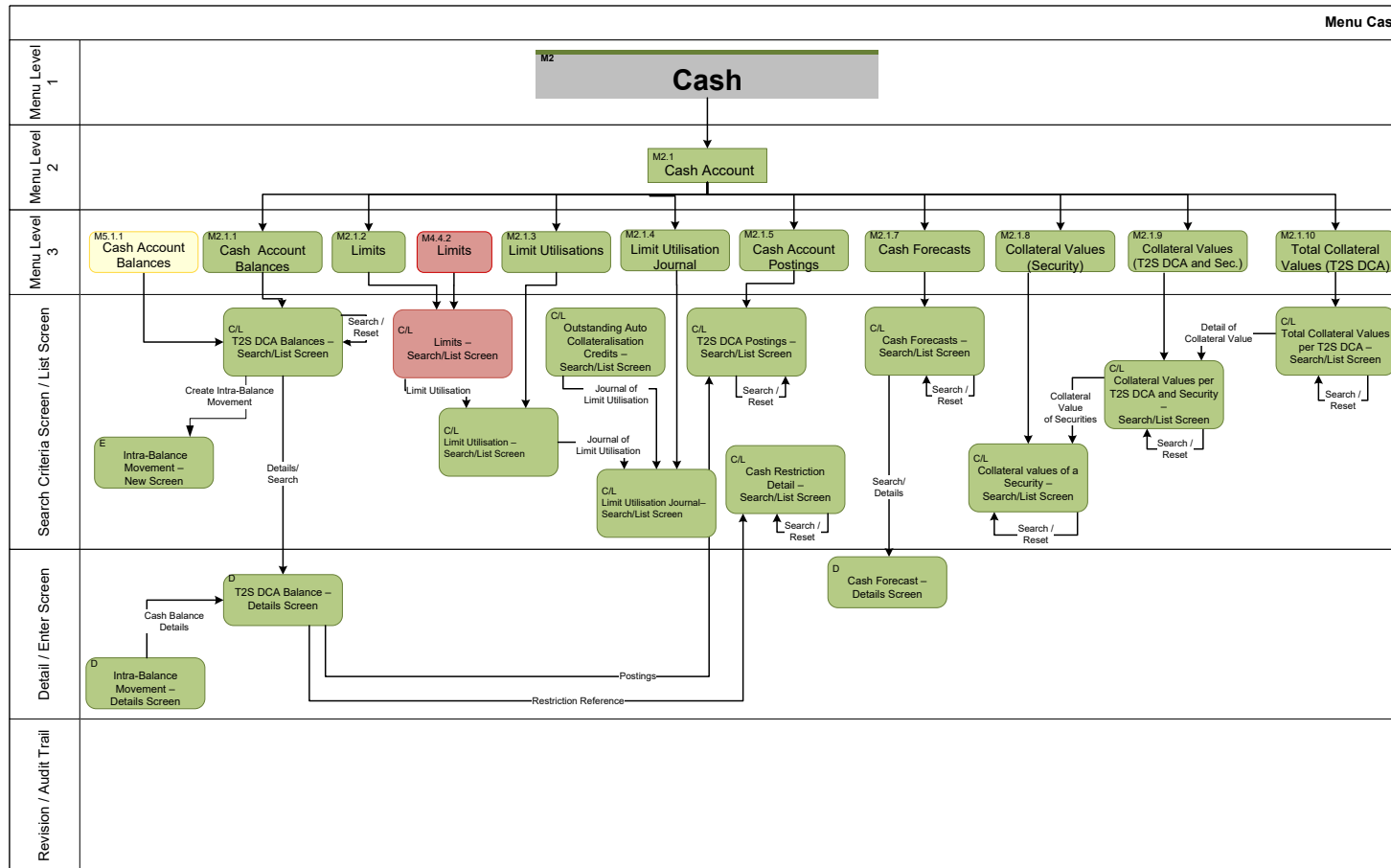

6.2.3.2 Liquidity

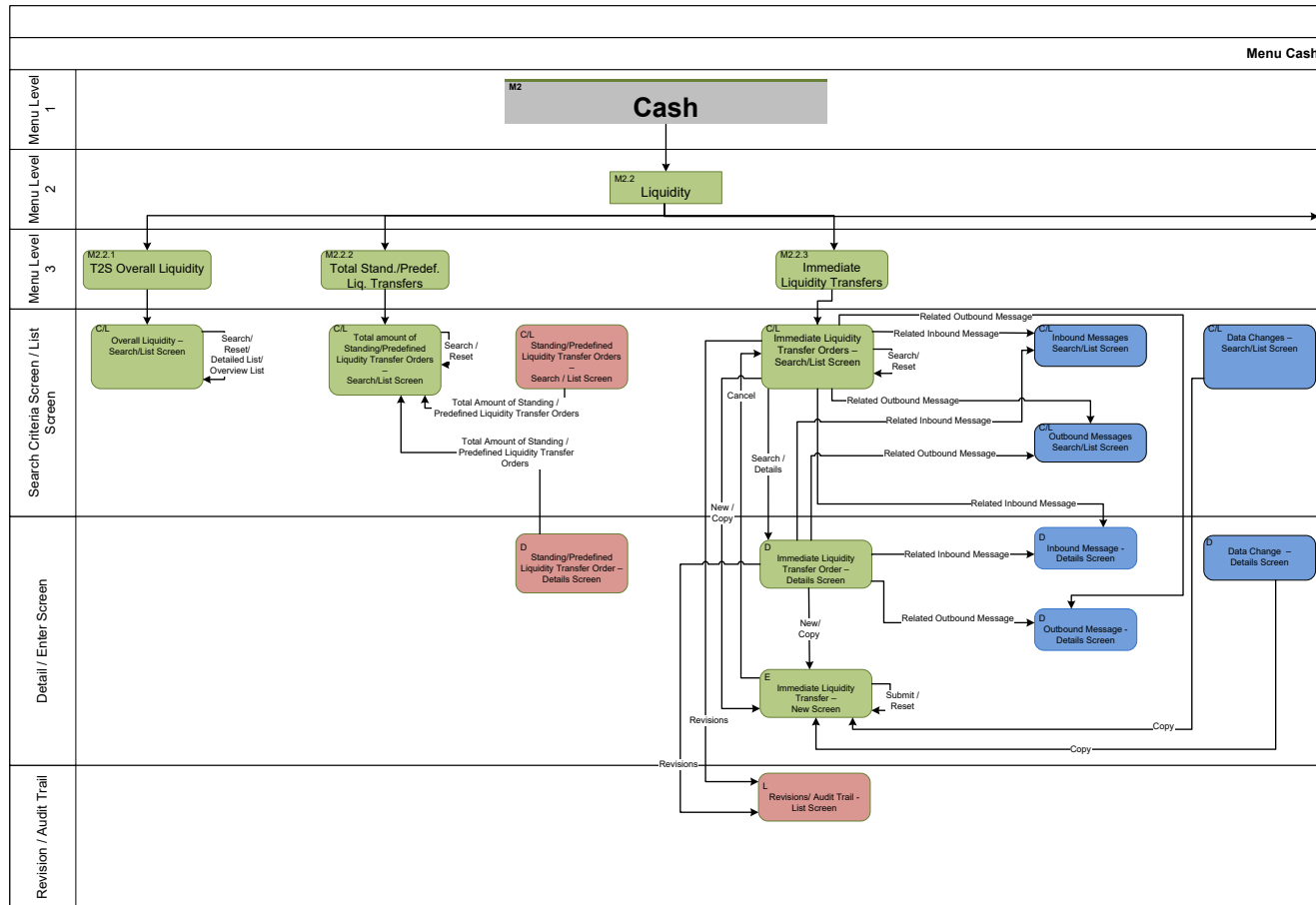

6.2.3.3 Liquidity II

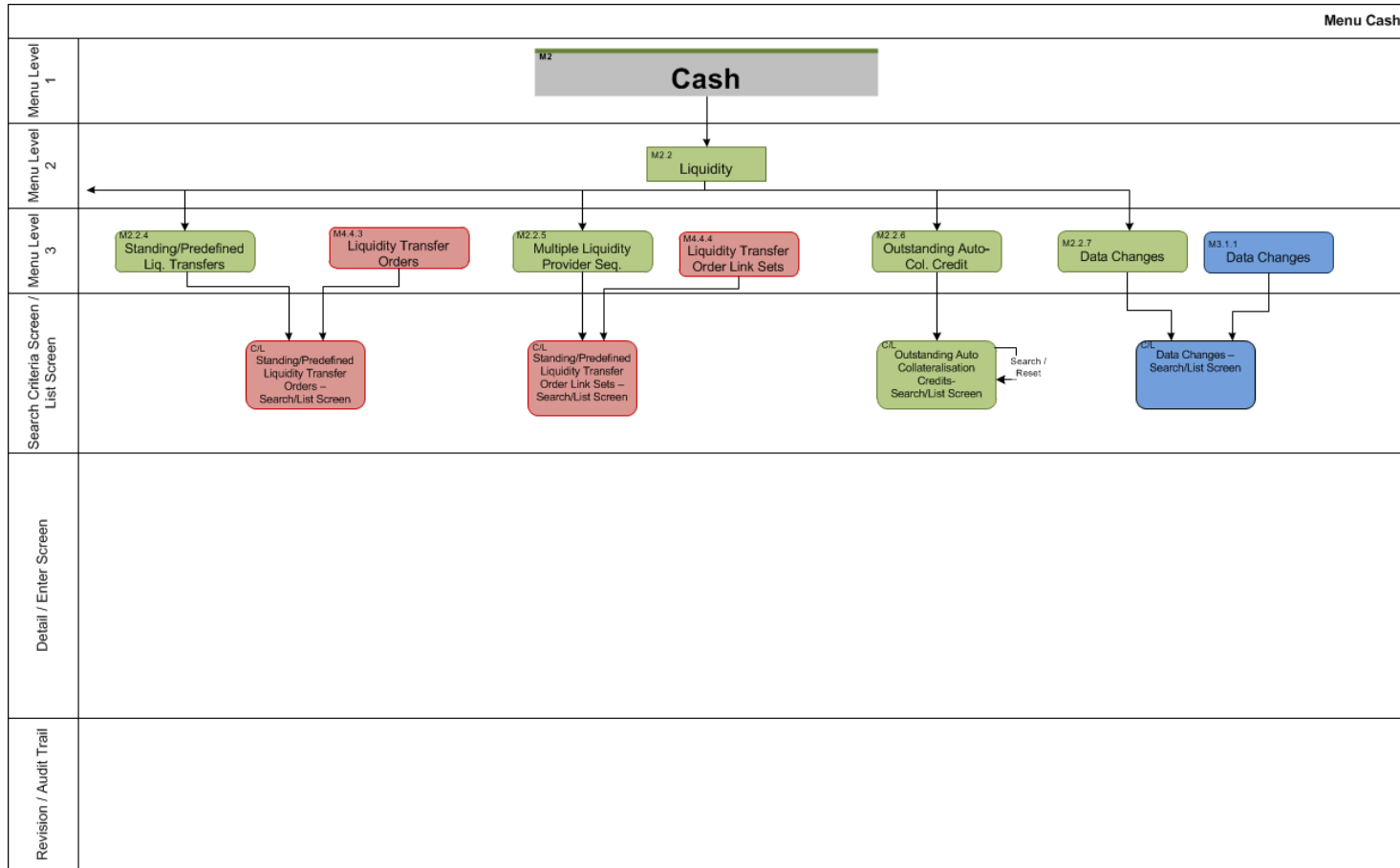

6.2.3.4 Settlement

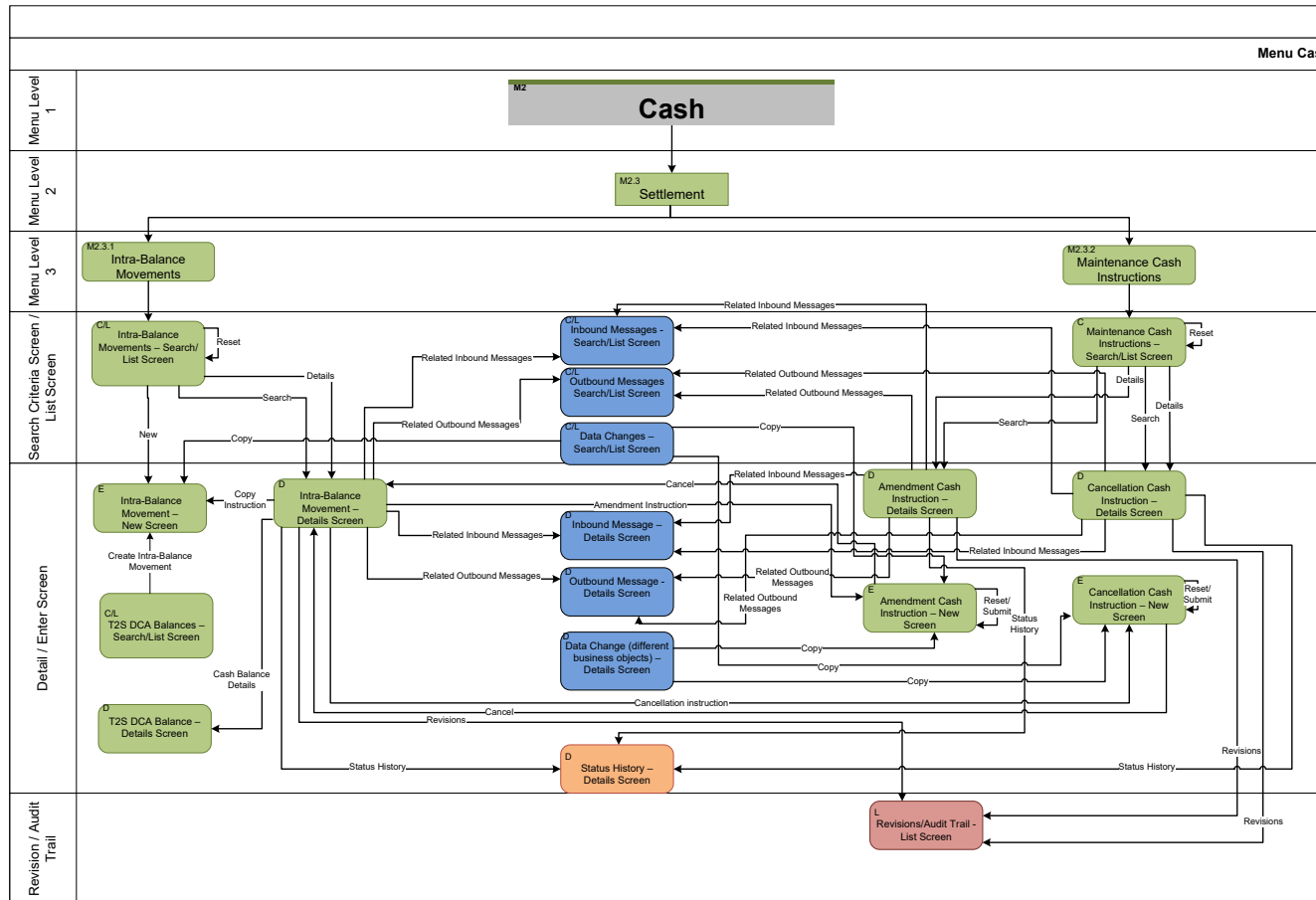

6.2.4 Services

6.2.4.1 Additional Services

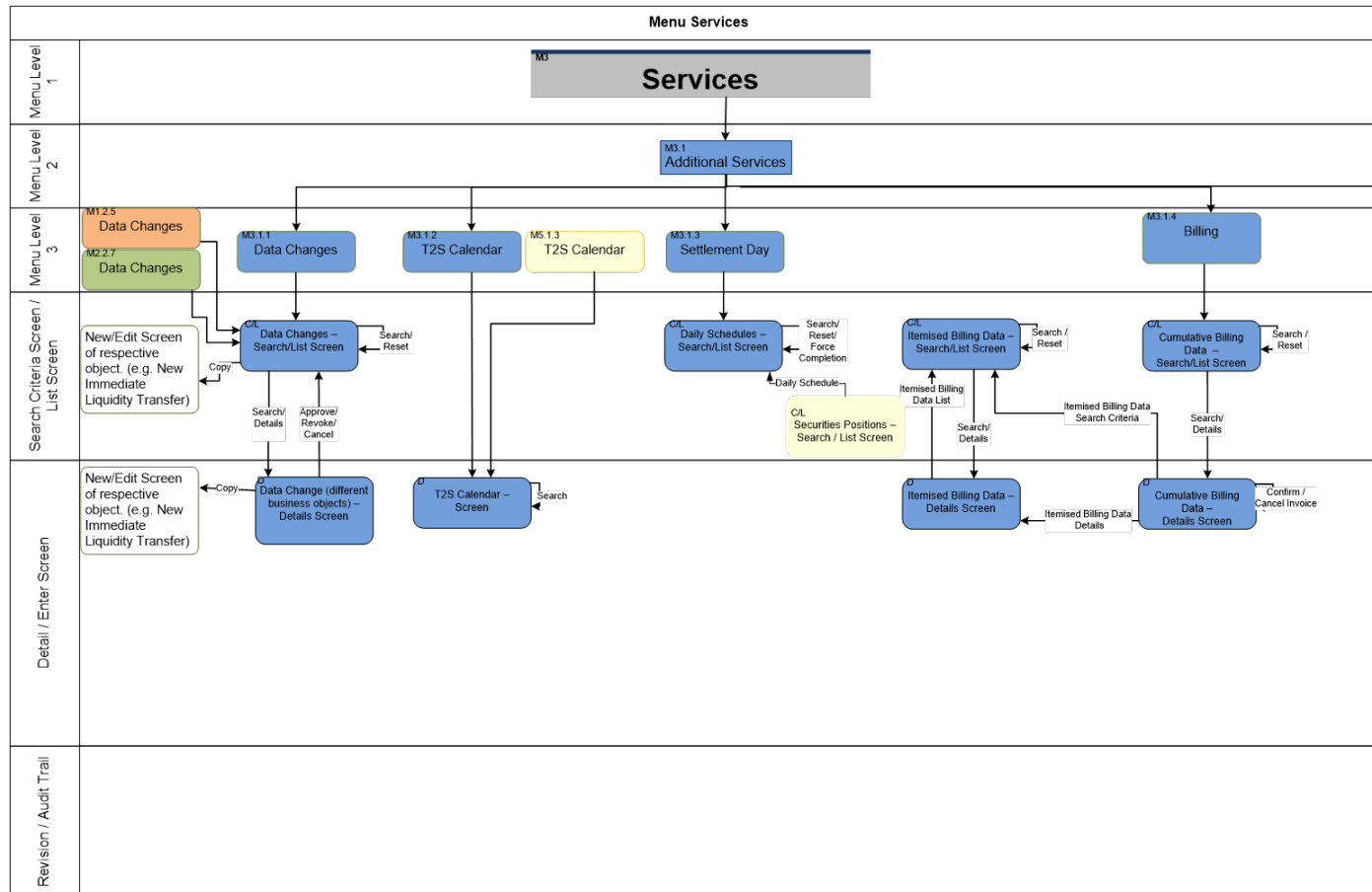

6.2.4.2 Additional Services II

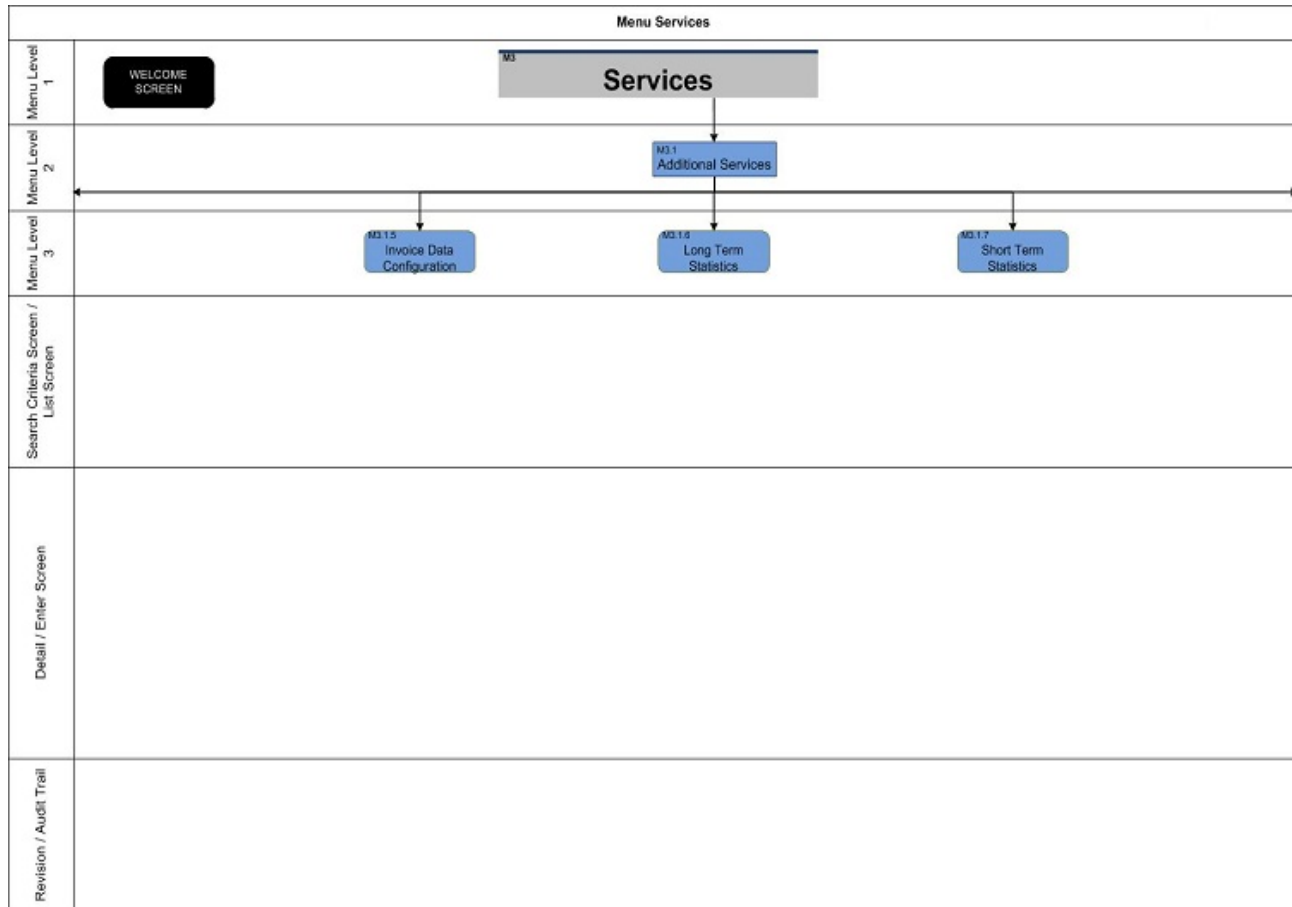

6.2.4.3 Additional Services III

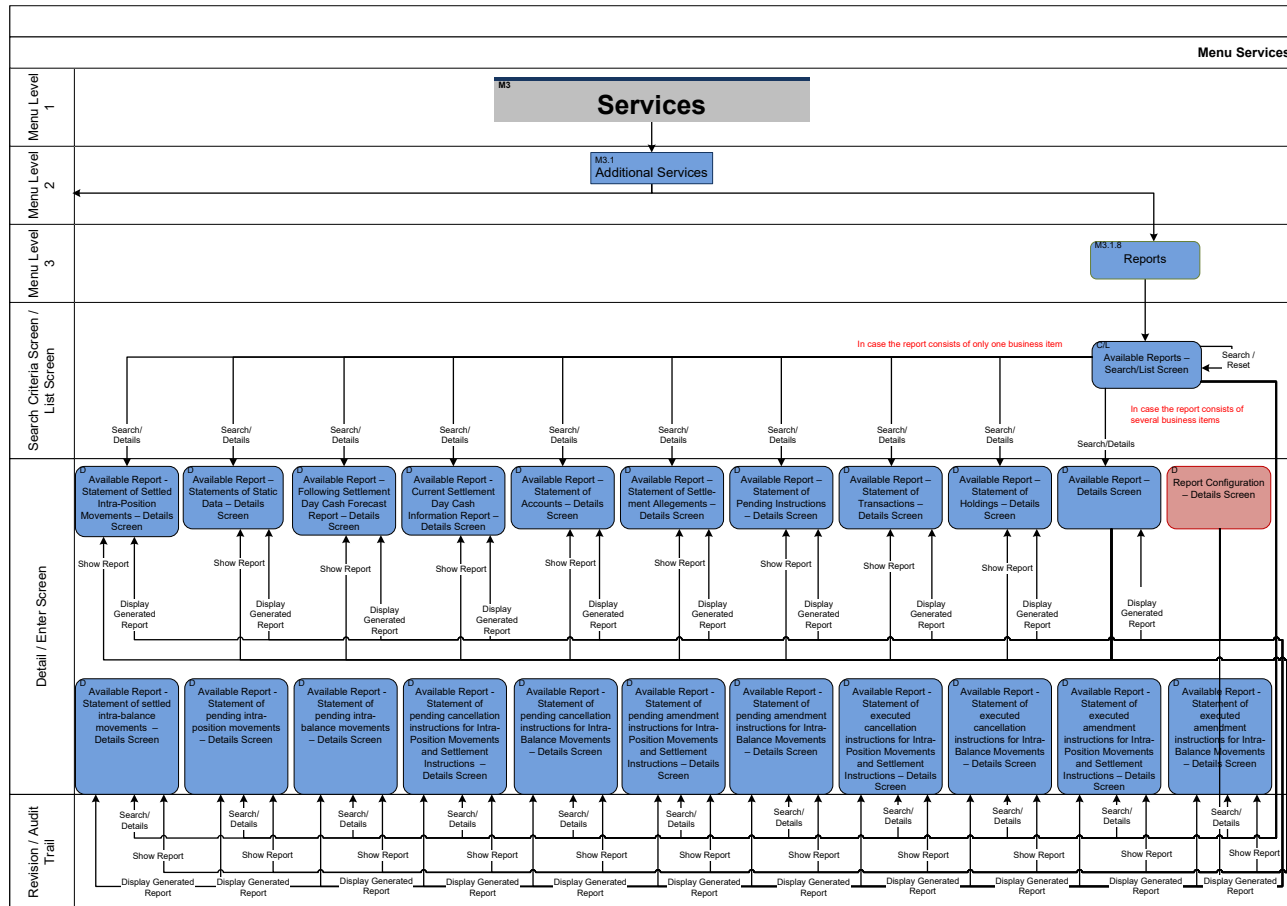

6.2.4.4 Additional Services IV



6.2.4.5 Additional Services V

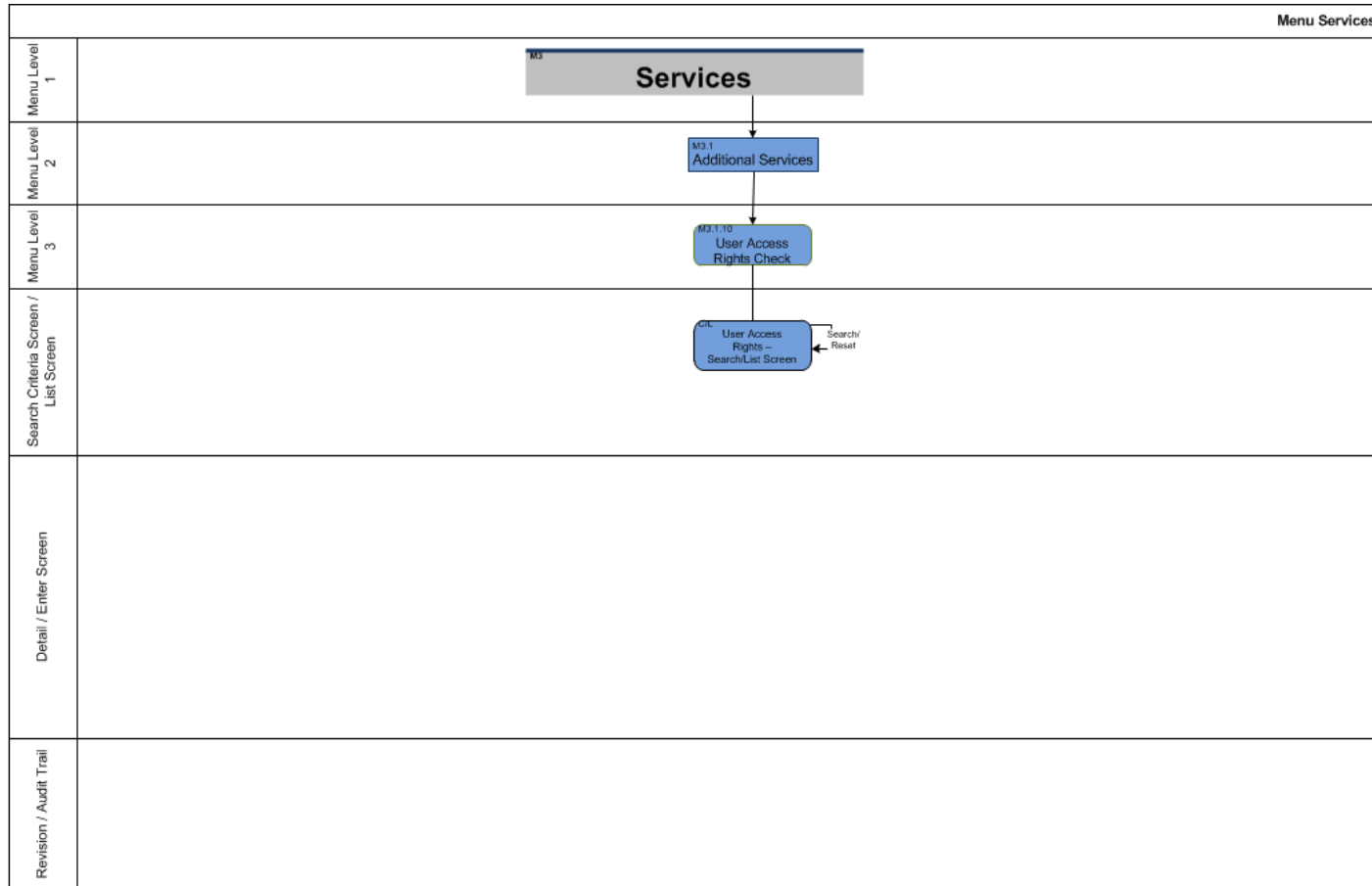

6.2.4.6 Additional Services VI

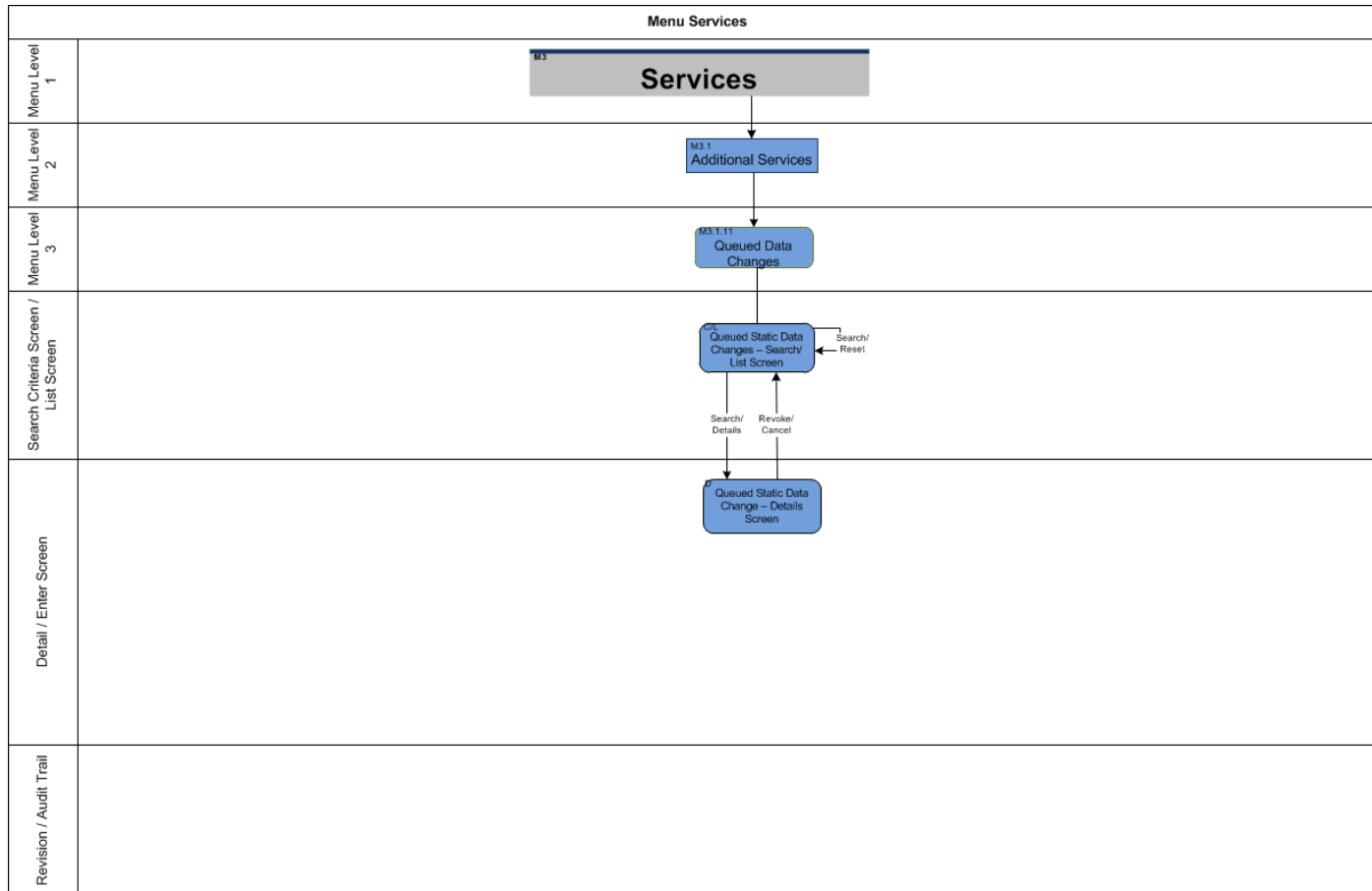

6.2.4.7 Communication

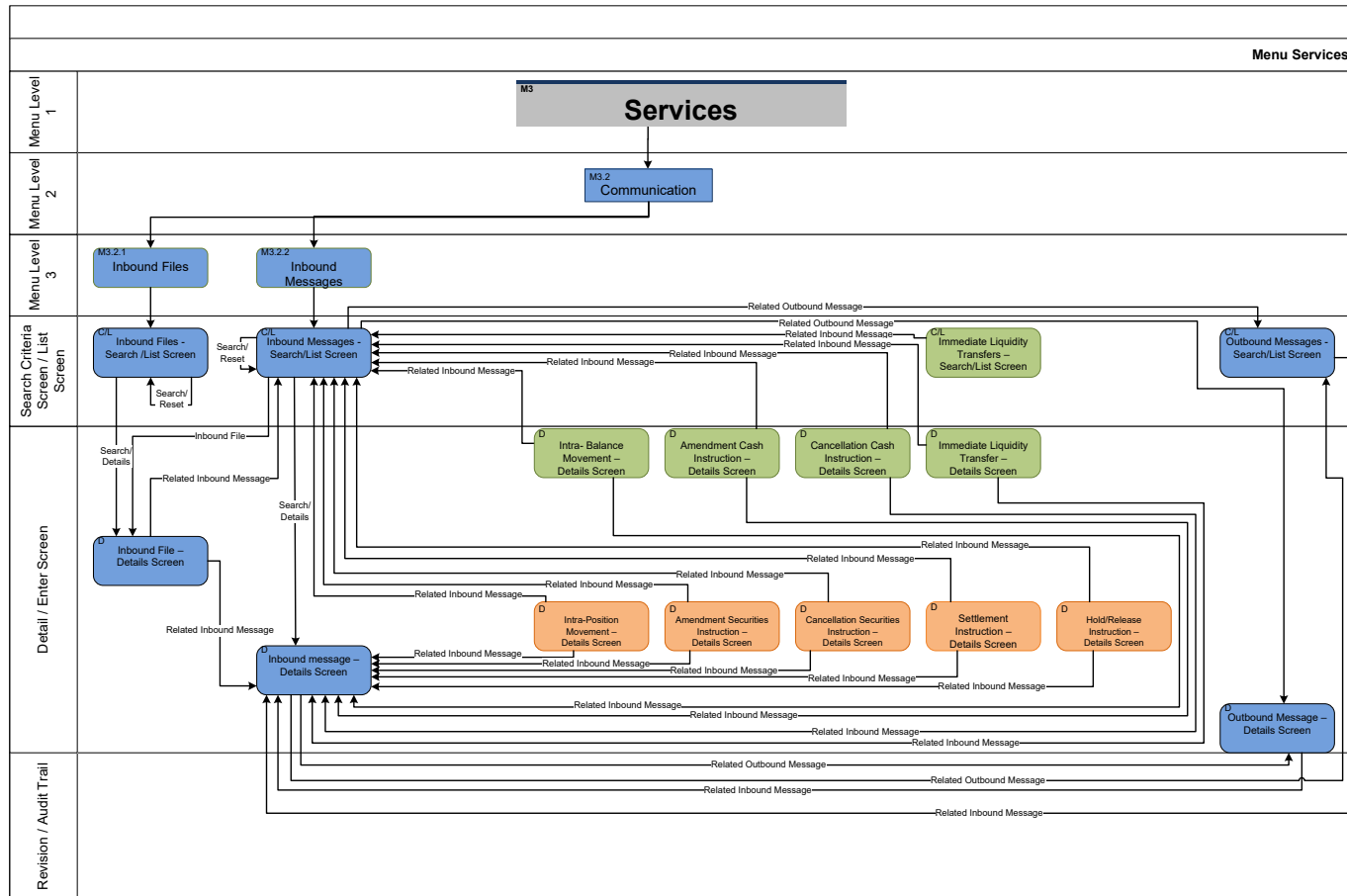

6.2.4.8 Communication II

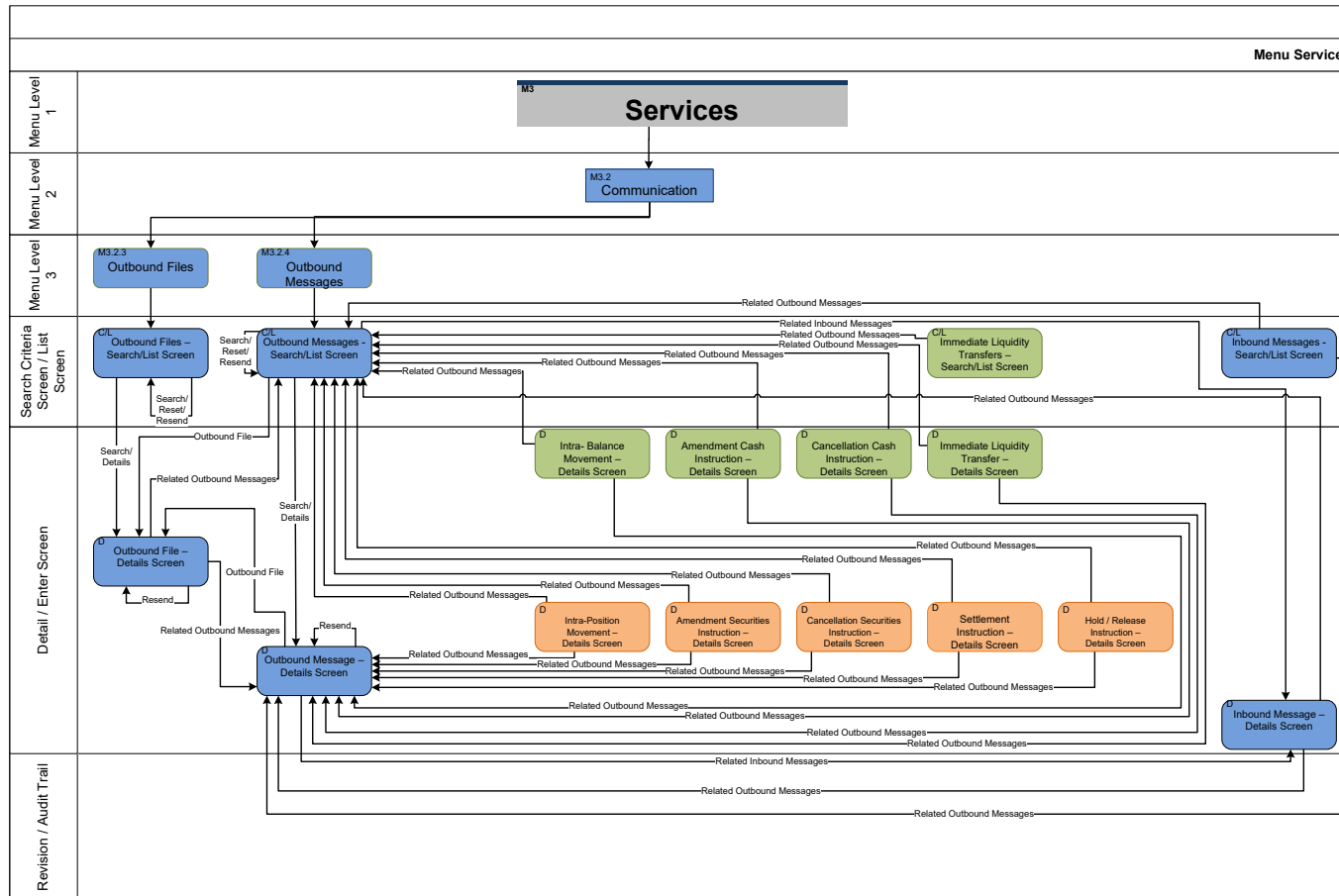

6.2.4.9 Communication III

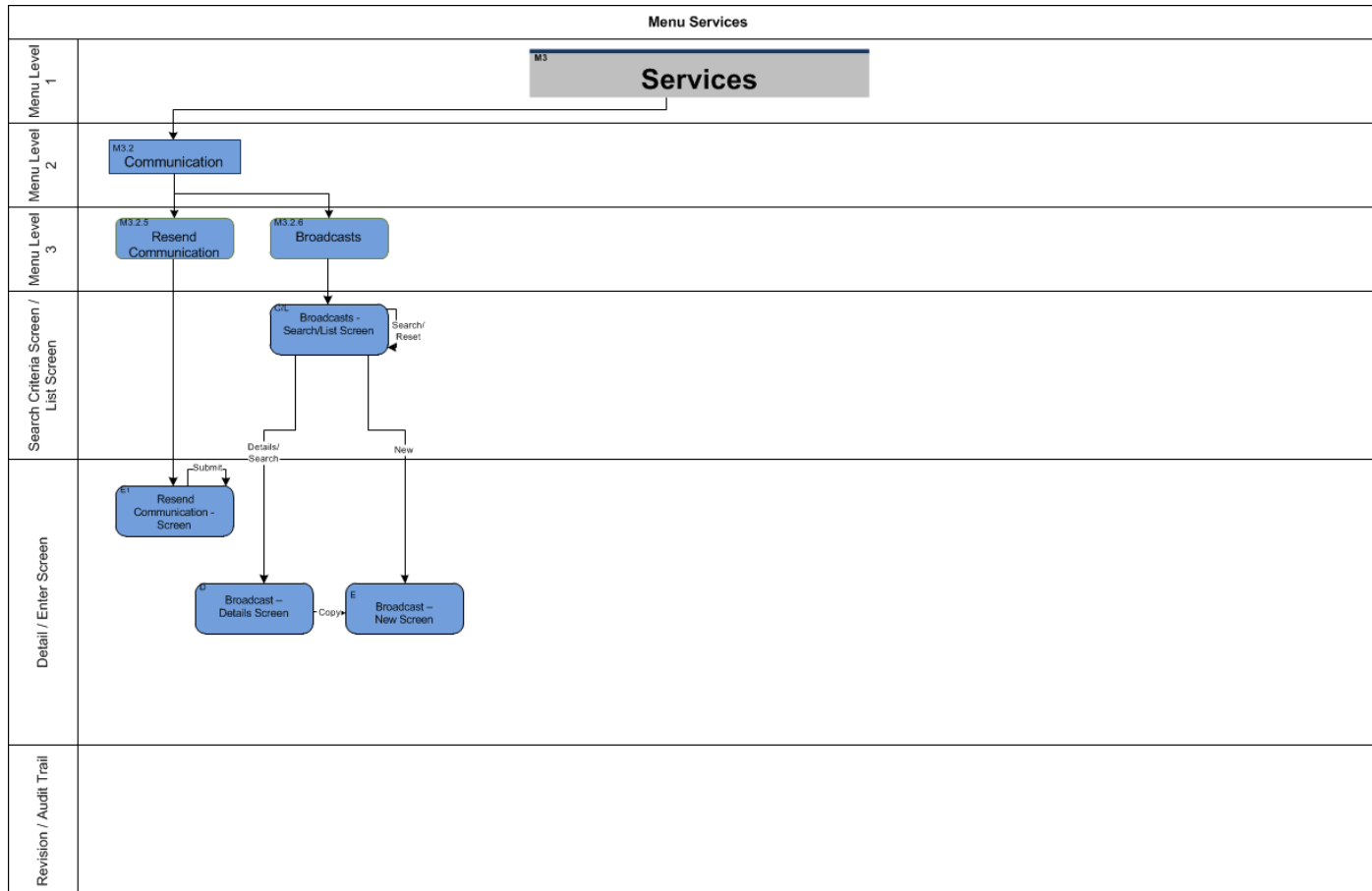

6.2.5 Monitoring

6.2.5.1 Monitoring

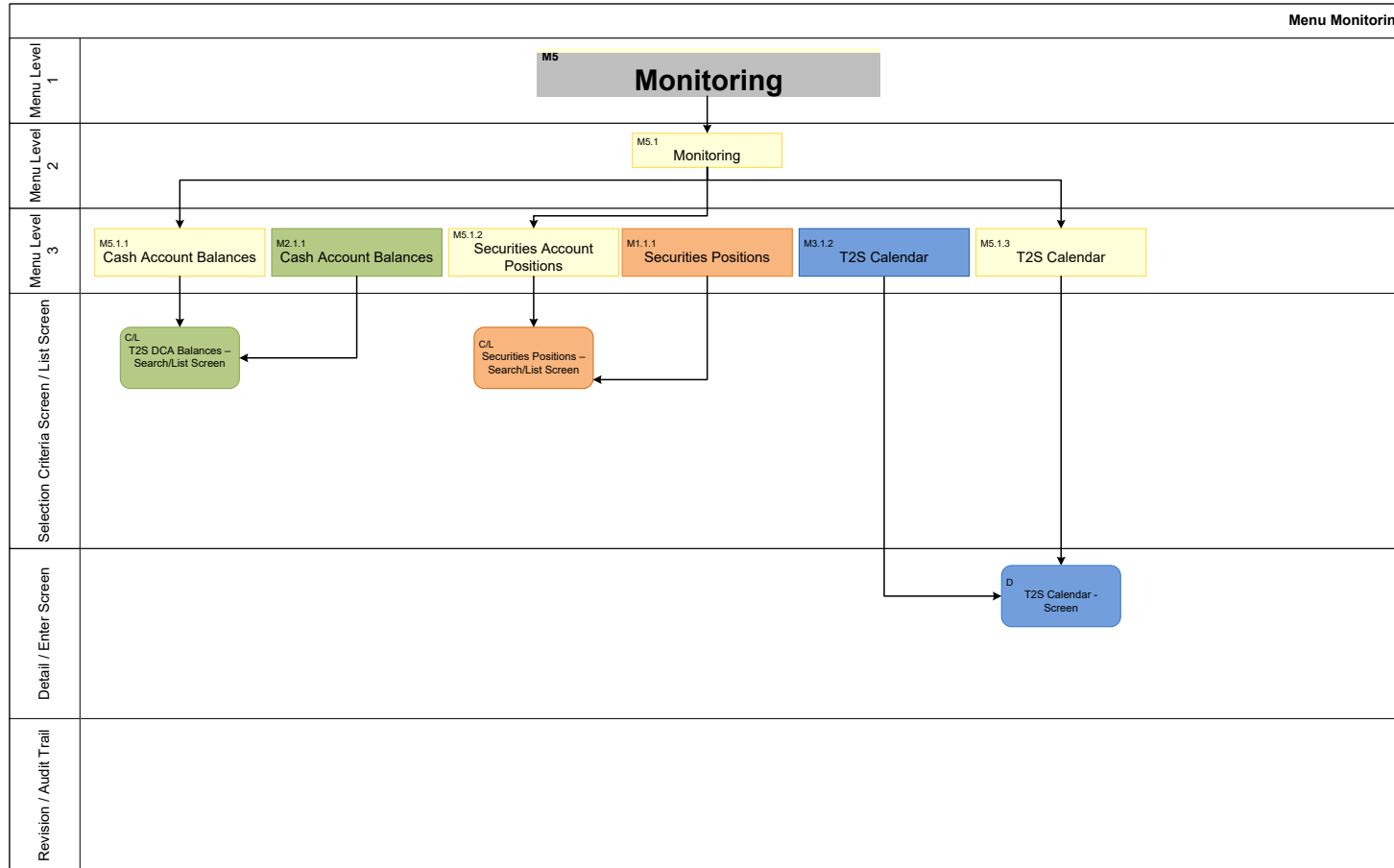

6.2.6 Business Day Management

6.2.6.1 Business Day Management

6.2.6.1.1 Settlement Day

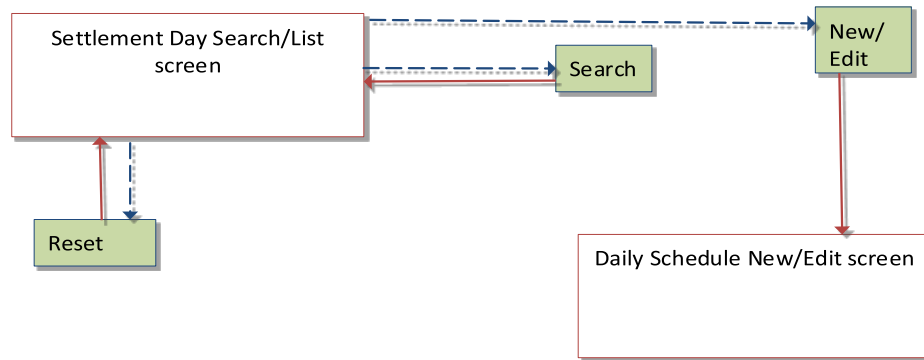



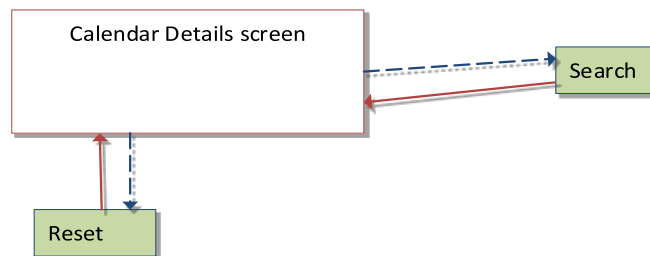

6.2.6.1.2 Calendar

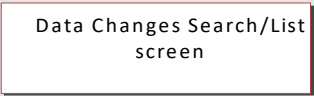

6.3 Sitemap for CoCo GUI

In the following sub-sections the reader may find the hierarchical, structured illustration of all the CoCo screens and their interrelations.

You can find below the legend which explains the meaning of each object, i.e. screen, button, dotted (blue) arrow, solid (red) arrow illustrated in the following diagrams.

Object in the diagram	Description
	The object represents a screen.
	When a button is displayed on the screen, a dotted blue arrow is shown as a link between the screen and the corresponding button.
	The object represents a button which is shown in the relevant screen.
	After a button is pressed, the result can be displayed either on the same screen or in a different screen (e.g. the details screen). {Split book approach}

6.3.1 Billing

6.3.1.1 Invoice Data

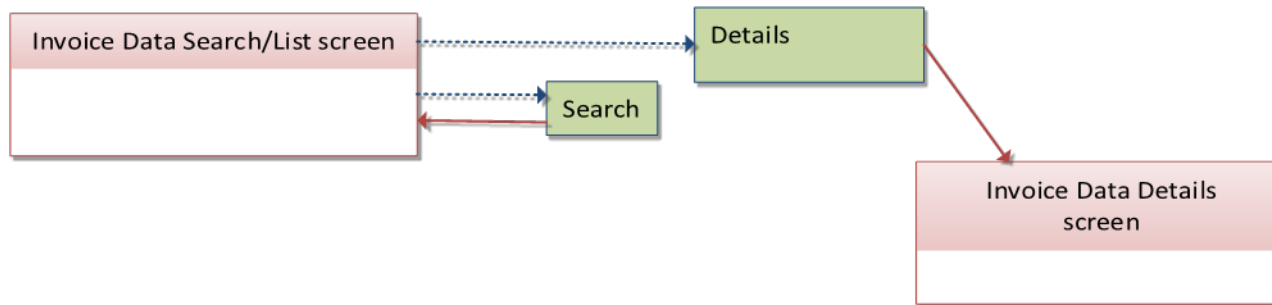

Illustration 369: {to be deleted due to split book approach}

6.3.1.2 Itemised Invoice Data

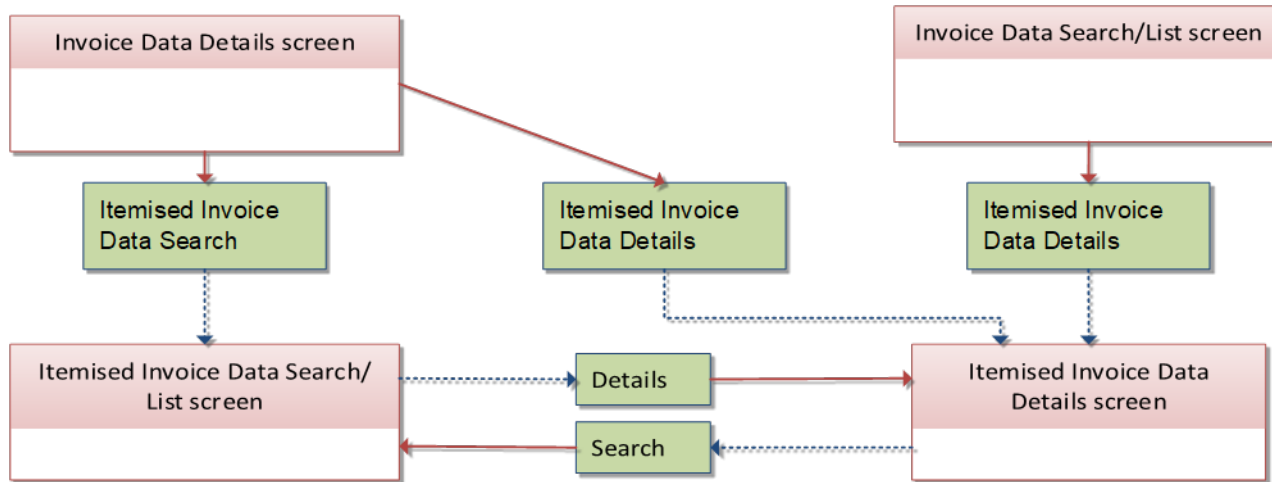

Illustration 370: {to be deleted due to split book approach}

6.3.1.3 Manual Correction

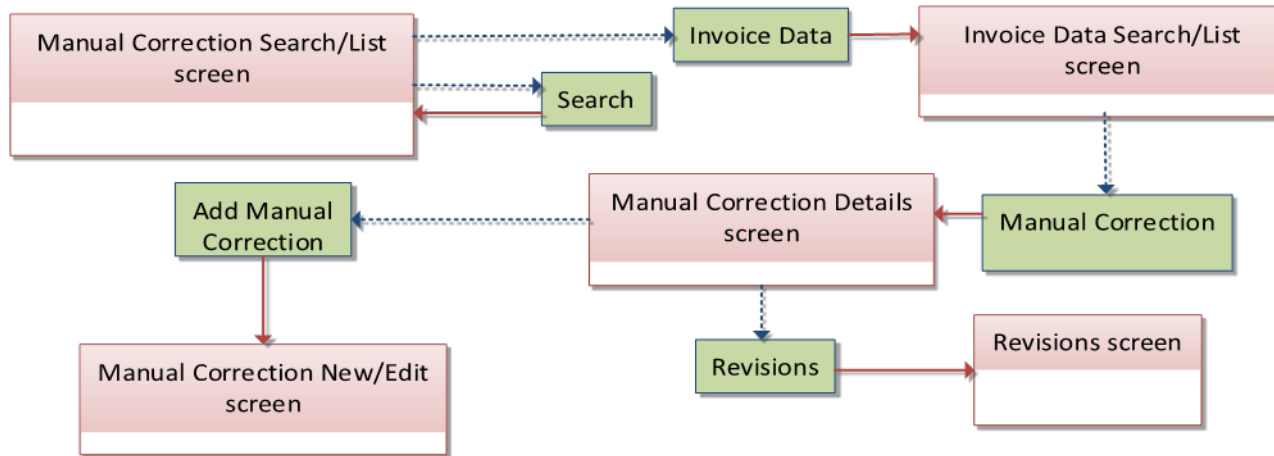

Illustration 371: {to be deleted due to split book approach}

6.3.1.4 PDF Invoice

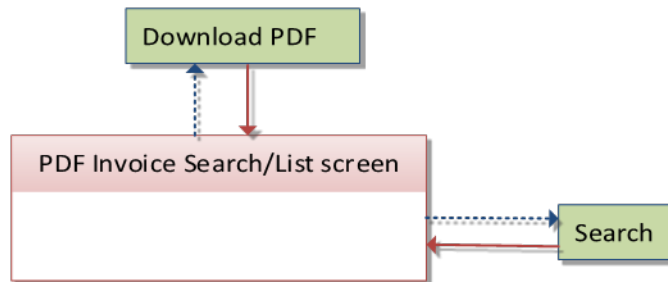

Illustration 372: {to be deleted due to split book approach}

6.3.2 Business Day Management

6.3.2.1 Settlement Day



Illustration 373: {to be deleted due to split book approach}

6.3.2.2 Calender

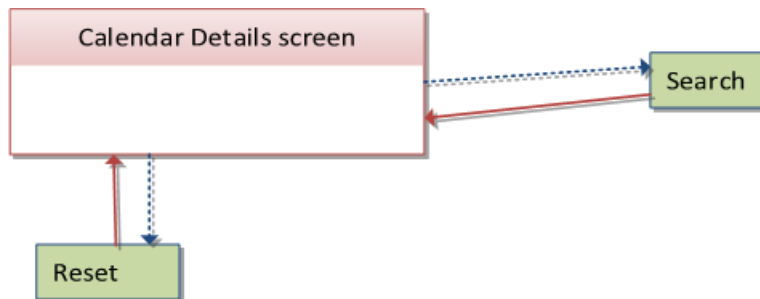

Illustration 374: {to be deleted due to split book approach}

6.4 List of Privileges

6.4.1 Reader's Guide

Reader's Guide

The list of privileges is divided for GUI screens. For GUI screens a list of privileges classes is included. Respectively, the list of privileges is structured in accordance with the alphabetical screen order and provides detailed information on privilege code, privilege type, object type and screen criteria related to each privilege.

6.4.2 Privilege Classes for GUI Screens

Class of Privileges	Privilege Name	Privilege Short Name
Access Rights Management	Create Privilege	ARM_CreatePrivilege
Access Rights Management	Update Privilege	ARM_UpdatePrivilege
Access Rights Management	Delete Privilege	ARM_DeletePrivilege
Access Rights Management	Grant Privilege	ARM_GrantPrivilege
Access Rights Management	Revoke Privilege	ARM_RevokePrivilege
Access Rights Management	Create Role	ARM_CreateRole
Access Rights Management	Update Role	ARM_UpdateRole
Access Rights Management	Delete Role	ARM_DeleteRole
Access Rights Management	Grant/Revoke Role	ARM_GrantRole
Access Rights Management	Create User	ARM_CreateUser
Access Rights Management	Update User	ARM_UpdateUser
Access Rights Management	Delete User	ARM_DeleteUser

Class of Privileges	Privilege Name	Privilege Short Name
Management		
Access Rights Management	Create Certificate Distinguish Name	ARM_CreateCertificateDN
Access Rights Management	Delete Certificate Distinguish Name	ARM_DeleteCertificateDN
Access Rights Management	Create User Certificate Distinguish Name Link	ARM_CreateUserCertificateDNLink
Access Rights Management	Delete User Certificate Distinguish Name Link	ARM_DeleteUserCertificateDNLink
Access Rights Management	Create Secured Group	ARM_CreateSecuredGroup
Access Rights Management	Update Secured Group	ARM_UpdateSecuredGroup
Access Rights Management	Delete Secured Group	ARM_DeleteSecuredGroup
Access Rights Management	Administer Party	ARM_AdministerParty
Access Rights Queries	Access Rights Query	ARQ_AccessRightsQuery
Access Rights Queries	Privilege Query	ARQ_PrivilegeQuery
Access Rights Queries	Role List Query	ARQ_RoleListQuery
Access Rights Queries	T2S System User Query (T2S Actor Query)	ARQ_T2SSysUserQueryT2SActorQuery
Access Rights Queries	Certificate Query	ARQ_CertificateDNQuery
Access Rights Queries	T2S System User Link Query	ARQ_UserCertificateDNLinkQuery
Access Rights Queries	Secured Group List Query	ARQ_SecuredGroupListQuery
Access Rights	Secured Group Details Query	ARQ_SecuredGroupDetailsQuery

Class of Privileges	Privilege Name	Privilege Short Name
Queries		
Access Rights Queries	Granted System Privileges List Query	ARQ_GrantedSysPrivilegesListQuery
Access Rights Queries	Granted Object Privileges List Query	ARQ_GrantObjectPrivilegesListQuery
Access Rights Queries	Granted Roles List Query	ARQ_Granted-RolesListQuery
Billing	Edit Invoice Data Configuration (update function)	BIL_NewInvoiceData-Config(update)
Billing	Invoice Processing Request – Cancellation	BIL_InvoiceProcessingReq-Cancellat
Billing	Invoice Processing Request – Confirmation	BIL_InvoiceProcessingReq-Confirmat
Billing	Invoice Processing Request – Generation	BIL_InvoiceProcessingReq-Generation
Billing	New Invoice Data Configuration (create function)	BIL_NewInvoiceData-Config(create)
Billing Configuration	Create Service Item	BIC_CreateServiceItem
Billing Configuration	Update Service Item	BIC_UpdateServiceItem
Billing Configuration	Delete Service Item	BIC_DeleteServiceItem
Billing Queries	PDF Invoice List Query	BIQ_PDFInvoiceListQuery
Cash Management	Amend Process Indicator Settlement Restriction on Cash on a Dedicated Cash Account	CAM_ASRCA
Cash Management	Cancel Settlement Restriction on Cash on a Dedicated Cash Account	CAM_CSRCA
Cash Management	Send New Liquidity Transfer	CAM_Send New Liquidity Transfer
Cash Management	Send New Settlement Restriction on Cash on a Dedicated Cash Account	CAM_SNDRC

Class of Privileges	Privilege Name	Privilege Short Name
Cash Management	Unblock CoSD Cash Blocking related to cancelled CoSD Settlement Instructions on Behalf of the relevant CSD in T2S	CAM_UCBBI
Dynamic Data Queries	Settlement Instruction Query	DDQ_SettlInstructQuery
Dynamic Data Queries	Settlement Instruction Query for possible restore actions	DDQ_SettlInstrQueryRestore
Dynamic Data Queries	Settlement Instruction Current Status Query	DDQ_SettlInstructCurrentStatusQuery
Dynamic Data Queries	Settlement Instruction Status Audit Trail Query	DDQ_SettlInstruct-StatusAuditTrailQu
Dynamic Data Queries	Settlement Instruction Audit Trail Query	DDQ_SettlInstructAudit-TrailQuery
Dynamic Data Queries	Securities Position Detailed Restriction Details Query	DDQ_SecurPosDetailedRestrDetailsQue
Dynamic Data Queries	Securities Posting Query	DDQ_SecuritiesPostingQuery
Dynamic Data Queries	Securities Account Position Query	DDQ_SecuritiesAccountPositionQuery
Dynamic Data Queries	Maintenance for Intra-Position Movements and Settlement Instructions Query	DDQ_MaintForIntra-PosMov+SettlInstrQ
Dynamic Data Queries	Amendment Instruction Query for Intra-Position Movements and Settlement Instructions	DDQ_AmendInstrQIntraPosMov+SetInstr
Dynamic Data Queries	Intra-Position Movements Query	DDQ_IntraPos-MovQuery
Dynamic Data Queries	Intra-Position Movements Query for possible restore actions	DDQ_Intra-PosQueryRestore

Class of Privileges	Privilege Name	Privilege Short Name
Dynamic Data Queries	Intra-Balance Movements Query for possible restore actions	DDQ_Intra-BalQueryRestore
Dynamic Data Queries	Allegement Query	DDQ_AllegementQuery
Dynamic Data Queries	Inbound Message List Query	DDQ_InboundMess-ListQuery
Dynamic Data Queries	Inbound Message Details Query	DDQ_InboundMess-DetailsQuery
Dynamic Data Queries	Outbound Message List Query	DDQ_OutboundMess-ListQuery
Dynamic Data Queries	Outbound Message Details Query	DDQ_OutboundMess-DetailsQuery
Dynamic Data Queries	Inbound Files List Query	DDQ_Inbound-FilesListQuery
Dynamic Data Queries	Inbound Files Details Query	DDQ_InboundFilesDe-tailsQuery
Dynamic Data Queries	Outbound Files List Query	DDQ_Outbound-FilesListQuery
Dynamic Data Queries	Outbound Files Details Query	DDQ_OutboundFiles-DetailsQuery
Dynamic Data Queries	Data Changes of a Business Object List Query	DDQ_DataChan-Busi-nessObjListQuery
Dynamic Data Queries	Data Changes of a Business Object Details Query	DDQ_DataChan-Busi-nessObjDetailQuery
Dynamic Data Queries	Intra-Positon Movement Audit Trail List Query	DDQ_IntraPos-MovAuditTrail-ListQuery
Dynamic Data Queries	Intra-Position Movement Audit Trail Details Query	DDQ_IntraPos-MovAuditTrailDe-tQuery
Dynamic Data Queries	Hold/Release Instruction Audit Trail List Query	DDQ_HoldReleIn-strAuditTrailLisQuery

Class of Privileges	Privilege Name	Privilege Short Name
Dynamic Data Queries	Hold/Release Instruction Audit Trail Details Query	DDQ_HoldReleInstrAuditTrailDetQuery
Dynamic Data Queries	Amendment Instruction for Intra-Position Movement or Settlement Instruction Audit Trail List Query	DDQ_AmdInsIntrPosMovSetInsAudTrLisQ
Dynamic Data Queries	Amendment Instruction for Intra-Position Movement or Settlement Instruction Audit Trail Details Query	DDQ_AmdInsIntrPosMovSetInsAudTrDetQ
Dynamic Data Queries	Cancellation Instruction for Intra-Balance Movement Audit Trail Details Query	DDQ_CanlInstrIntraBalanMovAudTrDetQ
Dynamic Data Queries	Cancellation Instruction for Intra-Balance Movement Audit Trail List Query	DDQ_CanlInstrIntraBalanMovAudTrLisQ
Dynamic Data Queries	Cancellation Instruction for Intra-Position Movement or Settlement Instruction Audit Trail List Query	DDQ_CanlInstrIntraPosMovAudTrLisQ
Dynamic Data Queries	Cancellation Instruction for Intra-Position Movement or Settlement Instruction Audit Trail Details Query	DDQ_CanlInstrIntraPosMovAudTrDetQ
Dynamic Data Queries	Cancellation Instruction Query for Intra-position Movements and Settlement Instructions	DDQ_CanlInstrForSI+IntraPosMovQuery
Dynamic Data Queries	Broadcast Query	DDQ_BroadcastQuery
Dynamic Data Queries	Amendment Instruction for Intra-Balance Movement Audit Trail Details Query	DDQ_AmdInstrForIntraBalMovAudTrDetQ
Dynamic Data Queries	Amendment Instruction for Intra-Balance Movement Audit Trail List Query	DDQ_AmdInstrForIntraBalMovAudTrLisQ

Class of Privileges	Privilege Name	Privilege Short Name
Dynamic Data Queries	Amendment Instruction Query for Intra-Balance Movements	DDQ_AmendInstrQueryForIntraBal-anMo
Dynamic Data Queries	Cancellation Instructions for Intra-Balance Movements Query	DDQ_CancelInstructIntraBalanMovQuery
Dynamic Data Queries	Cash Forecast Query	DDQ_CashForecastQuery
Dynamic Data Queries	Collateral Value of a Security Query	DDQ_CollatValue-of-SecurityQuery
Dynamic Data Queries	Collateral Value per T2S Dedicated Cash Account Query	DDQ_CollatValuePer-T2SDCAQuery
Dynamic Data Queries	Immediate Liquidity Transfer Order Audit Trail Details Query	DDQ_ImmedLiquidityTransOrderAuditTrailQuery
Dynamic Data Queries	Immediate Liquidity Transfer Order Audit Trail List Query	DDQ_ImmedLiquidityTransOrderAuditTrailListQuery
Dynamic Data Queries	Immediate Liquidity Transfer Order Detail Query	DDQ_ImmedLiquidityTransOrderDetailQuery
Dynamic Data Queries	Immediate Liquidity Transfer Order List Query	DDQ_ImmedLiquidityTransOrderListQuery
Dynamic Data Queries	Intra-Balance Movement Audit Trail Detail Query	DDQ_IntraBalanceMovementAuditTrailDetailQuery
Dynamic Data Queries	Intra-Balance Movement Audit Trail List Query	DDQ_IntraBalanceMovementAuditTrailListQuery
Dynamic Data Queries	Intra-Balance Movements Query	DDQ_IntraBalanceMovQuery
Dynamic Data Queries	Limit Utilisation Journal Query	DDQ_LimitUtilisation-JournalQuery
Dynamic Data Queries	Limit Utilisation Query	DDQ_LimitUtilisation-Query

Class of Privileges	Privilege Name	Privilege Short Name
Dynamic Data Queries	Maintenance Instruction for Intra-Balance Movements Query	DDQ_MaintInstrForIntraBalanMovQuer
Dynamic Data Queries	Outstanding Auto-Collateralisation Credit Query	DDQ_OutstandAutoCollCreditQuery
Dynamic Data Queries	T2S Dedicated Cash Account Balance Detailed Restrictions Query	DDQ_T2SDCABalanDetailedRestrictionQuery
Dynamic Data Queries	T2S Dedicated Cash Account Balance Query	DDQ_T2SDedicatedCashAccBalanceQuery
Dynamic Data Queries	T2S Dedicated Cash Account Posting Query	DDQ_T2SDedicatedCashAccPostingQuery
Dynamic Data Queries	T2S Overall Liquidity Query	DDQ_T2SOverallLiquidityQuery
Dynamic Data Queries	Total Collateral Value per T2S Dedicated Cash Account Query	DDQ_TotalCollatValuePerT2SDCAQuery
Dynamic Data Queries	Settlement Instruction Matched and Accepted Status Query Privilege	DDQ_SettlInstrMtchAcceptStsQuery
General Configuration Parameters	Create Country	GCP_CreateCountry
General Configuration Parameters	Update Country	GCP_UpdateCountry
General Configuration Parameters	Delete Country	GCP_DeleteCountry
General Configuration Parameters	Create Currency	GCP_CreateCurrency
General Configuration Parameters	Update Currency	GCP_UpdateCurrency
General Configuration Parameters	Delete Currency	GCP_DeleteCurrency
General Configuration Parameters	Create Partial Settlement Threshold	GCP_CreatePartialSettlThreshold
General Configuration Parameters	Update Partial Settlement Threshold	GCP_UpdatePartialSettlThreshold

Class of Privileges	Privilege Name	Privilege Short Name
General Configuration Parameters	Delete Partial Settlement Threshold	GCP_DeletePartial-SettlThreshold
General Configuration Parameters	Create System Entity	GCP_CreateSystemEntity
General Configuration Parameters	Update System Entity	GCP_UpdateSystemEntity
General Configuration Parameters	Create Tolerance Amount	GCP_CreateToleranceAmount
General Configuration Parameters	Update Tolerance Amount	GCP_UpdateToleranceAmount
General Configuration Parameters	Delete Tolerance Amount	GCP_DeleteToleranceAmount
Market-Specific Configuration	Create Attribute Domain	MSC_CreateAttribute-Domain
Market-Specific Configuration	Update Attribute Domain	MSC_UpdateAttribute-Domain
Market-Specific Configuration	Delete Attribute Domain	MSC_DeleteAttribute-Domain
Market-Specific Configuration	Create Attribute Reference	MSC_CreateAttributeReference
Market-Specific Configuration	Update Attribute Reference	MSC_UpdateAttributeReference
Market-Specific Configuration	Delete Attribute Reference	MSC_DeleteAttributeReference
Market-Specific Configuration	Create Market-Specific Attribute	MSC_CreateMarket-SpecificAttribute
Market-Specific Configuration	Update Market-Specific Attribute	MSC_UpdateMarket-SpecificAttribute
Market-Specific Configuration	Delete Market-Specific Attribute	MSC_DeleteMarket-SpecificAttribute
Market-Specific Configuration	Create Restriction Type	MSC_CreateRestrictionType
Market-Specific Configuration	Update Restriction Type	MSC_UpdateRestrictionType

Class of Privileges	Privilege Name	Privilege Short Name
Market-Specific Configuration	Delete Restriction Type	MSC_DeleteRestrictionType
Market-Specific Configuration	Create Restriction Type Rule	MSC_CreateRestrictionTypeRule
Market-Specific Configuration	Update Restriction Type Rule	MSC_UpdateRestrictionTypeRule
Market-Specific Configuration	Delete Restriction Type Rule	MSC_DeleteRestrictionTypeRule
Market-Specific Configuration	Create Conditional Security Delivery Rule Set	MSC_CreateConditSecurDelivRuleSet
Market-Specific Configuration	Update Conditional Security Delivery Rule Set	MSC_UpdateConditSecurDelivRuleSet
Market-Specific Configuration	Delete Conditional Security Delivery Rule Set	MSC_DeleteConditSecurDelivRuleSet
Market-Specific Configuration	Create Conditional Security Delivery Rule	MSC_CreateConditSecurDelivRule
Market-Specific Configuration	Update Conditional Security Delivery Rule	MSC_UpdateConditSecurDelivRule
Market-Specific Configuration	Delete Conditional Security Delivery Rule	MSC_DeleteConditSecurDelivRule
Message Management	Resend Communication	MMA_Resend Communication
Message Management	Third party receipt	MMA_Third party receipt
Message Subscription	Create Message Subscription Rule Set	MSU_CreateMessSubsRuleSet
Message Subscription	Update Message Subscription Rule Set	MSU_UpdateMessSubscriptionRuleSet
Message Subscription	Delete Message Subscription Rule Set	MSU_DeleteMessSubscriptionRuleSet
Message Subscription	Create Message Subscription Rule	MSU_CreateMessageSubscriptionRule

Class of Privileges	Privilege Name	Privilege Short Name
Message Subscription	Update Message Subscription Rule	MSU_UpdateMessageSubscriptionRule
Message Subscription	Delete Message Subscription Rule	MSU_DeleteMessageSubscriptionRule
Message Subscription Queries	Message Subscription Rule Set List Query	MSQ_MessSubscrRuleSetListQuery
Message Subscription Queries	Message Subscription Rule List Query	MSQ_MessSubscrRuleListQuery
Message Management	RTGS answer	MMA_RTGS answer
Message Management	New Broadcast	MMA_New Broadcast
Message Subscription Queries	Message Subscription Rule Set Details Query	MSQ_MessSubscrRuleSetDetailQuery
MSA Data Queries	Attribute Domain List Query	MSA_AttributeDomainListQuery
MSA Data Queries	Attribute Domain Details Query	MSA_AttributeDomainDetailsQuery
MSA Data Queries	Market-specific Attribute List Query	MSA_Market-SpecAttributeQuery
MSA Data Queries	Market-specific Attribute Detail Query	MSA_Market-SpecAttributeDetailQuery
MSA Data Queries	Market-specific Restriction List Query	MSA_Market-SpecRestrictListQuery
MSA Data Queries	Conditional Security Delivery Rule Set Query	MSA_ConditSecDeliveryRuleSetQuery
MSA Data Queries	Attribute Reference List Query	MSA_DisplayAttribDomainRefListQuery
MSA Data Queries	Market-specific Restriction Type Rule Detail Query	MSA_Market-SpecRestrictDetailQuery
MSA Data Queries	Market-specific Restriction Type Rule Set List Query	MSA_MarkSpecRestrTypeRuleSetListQue

Class of Privileges	Privilege Name	Privilege Short Name
MSA Data Queries	Market-specific Restriction Type Rule Parameter Details Query	MSA_MarkSpecRestr-TypeRuleParamDetQ
MSA Data Queries	Conditional Security Delivery Rule List Query	MSA_ConditSecDeliveryRuleQuery
MSA Data Queries	Attribute Reference Details Query	MSA_DisplayAttribDomainRefDetQuery
Network Configuration	Create Network Service	NCO_CreateNetwork-Service
Network Configuration	Update Network Service	NCO_UpdateNetwork-Service
Network Configuration	Delete Network Service	NCO_DeleteNetwork-Service
Network Configuration	Create Routing	NCO_CreateRouting
Network Configuration	Update Routing	NCO_UpdateRouting
Network Configuration	Delete Routing	NCO_DeleteRouting
Network Configuration	Create Technical Address Network Service Link	NCO_CreateTechnAd-dressNetServLink
Network Configuration	Update Technical Address Network Service Link	NCO_UpdateTech-nAddressNetServLink
Network Configuration	Delete Technical Address Network Service Link	NCO_DeleteTechnAd-dressNetServLink
Network Configuration	Create T2S BIC Directory	NCO_CreateT2SBIC-Directory
Network Configuration	Update T2S BIC Directory	NCO_UpdateT2SBIC-Directory
Network Configuration	Delete T2S BIC Directory	NCO_DeleteT2SBIC-Directory
Network Configuration Queries	T2S BIC Query	NCQ_T2SBICQuery

Class of Privileges	Privilege Name	Privilege Short Name
Network Configuration Queries	Network Service List query	NCQ_NetworkServiceListquery
Network Configuration Queries	Routing List Query	NCQ_RoutingListQuery
Network Configuration Queries	Technical Address Network Service Link Details Query	NCQ_DisplayTechAddressNetSerLink
Party Data Management	Create Party	PDM_CreateParty
Party Data Management	Update Party	PDM_UpdateParty
Party Data Management	Delete Party	PDM_DeleteParty
Party Data Queries	Party Audit Trail Query	PDQ_PartyAudTrailQuery
Party Data Queries	Party Reference Data Query	PDQ_PartyReferenceDataQuery
Party Data Queries	Party List Query	PDQ_PartyListQuery
Party Data Queries	Restricted Party Query	PDQ_RestrictedPartyQuery
Report Configuration	Create Report Configuration	RCO_CreateReportConfiguration
Report Configuration	Update Report Configuration	RCO_UpdateReportConfiguration
Report Configuration	Delete Report Configuration	RCO_DeleteReportConfiguration
Report Configuration Queries	Report Configuration Details Query	RCO_ReportConfigurationDetailQuery
Report Configuration Queries	Report Configuration List Query	RCO_ReportConfigurationListQuery
Report Queries	Report List Query	RCO_ReportListQuery

Class of Privileges	Privilege Name	Privilege Short Name
Report Queries	Report Details Query	RCO_ReportDe- tailsQuery
SAC Data Queries	Securities Account List Query	SAQ_SecuritiesAc- countListQuery
SAC Data Queries	Securities Account Reference Data Query	SAQ_SecuritiesAc- cReferenceDataQuery
SAC Data Queries	Securities Account Audit Trail Query	SAQ_SecuritiesAc- cAudTrailQuery
SAC Data Queries	CSD Account Link Query	SAQ_CSDAccount- LinkQuery
SAC Data Queries	CMB Securities Account Link List Query	SAQ_DisplayCMB- SecAccLinkListQuery
Scheduling	Create Closing Day	SCH_CreateClosing- Day
Scheduling	Update Closing Day	SCH_UpdateClosing- Day
Scheduling	Delete Closing Day	SCH_DeleteClosing- Day
Scheduling	Create Event Type	SCH_CreateEvent- Type
Scheduling	Update Event Type	SCH_UpdateEvent- Type
Scheduling	Delete Event Type	SCH_DeleteEvent- Type
Scheduling	Create Operating Day Type	SCH_CreateOperat- ingDayType
Scheduling	Update Operating Day Type	SCH_UpdateOperat- ingDayType
Scheduling	Delete Operating Day Type	SCH_DeleteOperat- ingDayType
Scheduling	Recycle Settlement Instruction On Demand	SCH_RecycleOn- Demand
Scheduling Queries	Event Type List Query	SCQ_EventTypeL- istQuery
Scheduling Queries	Event Type Details Query	SCQ_EventTypeDe- tailsQuery

Class of Privileges	Privilege Name	Privilege Short Name
Scheduling Queries	Operating Day Type List Query	SCQ_OperatingDay-TypeListQuery
Scheduling Queries	Operating Day Type Details Query	SCQ_OperatingDay-TypeDetailsQuery
Scheduling Queries	Closing Day Query	SCQ_Closing-DayQuery
Scheduling Queries	Default Event Schedule De-tails Query	SCQ_De-faultEventSchedDe-tailsQuery
Scheduling Queries	Current Status of the T2S settlement day	SCQ_CurrStatusOfT2SSettlDay
Scheduling Queries	T2S Calendar Query	SCQ_T2SCalendar-Query
Scheduling Queries	T2S Diary Query	SCQ_T2SDiaryQuery
Securities Account Data Management	Create Securities Account	SAC_CreateSecuritiesAccount
Securities Account Data Management	Update Securities Account	SAC_UpdateSecuritiesAccount
Securities Account Data Management	Delete Securities Account	SAC_DeleteSecuritiesAccount
Securities Account Data Management	Create CSD Account Link	SAC_CreateCSDAccountLink
Securities Account Data Management	Update CSD Account Link	SAC_UpdateCSDAccountLink
Securities Account Data Management	Delete CSD Account Link	SAC_DeleteCSDAccountLink
Securities Account Data Management	Create CMB Securities Account Link	SAC_CreateCMBSecuritiesAccountLink
Securities Account Data Management	Delete CMB Securities Account Link	SAC_DeleteCMBSecuritiesAccountLink
Securities Account Data Management	Update CMB Securities Account Link	SAC_UpdateCMBSecuritiesAccountLink
Securities Penalties	SEP_PenaltyAuditTrailQuery	System
Securities Penalty Reference Data Management	Create Securities Subject to Cash Penalties	SPD_CreateSecSubjecttoCashPenalties

Class of Privileges	Privilege Name	Privilege Short Name
Securities Penalty Reference Data Management	Update Securities Subject to Cash Penalties	SPD_UpdateSecSubjecttoCashPenalties
Securities Penalty Reference Data Management	Delete Securities Subject to Cash Penalties	SPD_DeleteSecSubjecttoCashPenalties
Securities Penalty Reference Data Management	Delete SME Growth Market	SPD_DeleteS-MEGrowthMarket
Securities Penalty Reference Data Management	Delete Security Penalty Rate	SPD_DeleteSecurityPenaltyRate
Securities Penalty Reference Data Management	Delete Cash Discount Penalty Rate	SPD_DeleteCashDiscountPenaltyRate
Securities Penalty Reference Data Management	Create Euro Foreign Exchange Rate	SPD_CreateEuroForeignExchangeRate
Securities Penalty Reference Data Management	Update Euro Foreign Exchange Rate	SPD_UpdateEuroForeignExchangeRate
Securities Penalty Reference Data Management	Delete Euro Foreign Exchange Rate	SPD_DeleteEuroForeignExchangeRate
Securities Penalty Reference Data Management	Create Daily Price	SPD_CreateDailyPrice
Securities Penalty Reference Data Management	Update Daily Price	SPD_UpdateDailyPrice
Securities Penalty Reference Data Management	Delete Daily Price	SPD_DeleteDailyPrice
Securities Penalty Reference Data Queries	Securities Subject to Cash Penalties Query	SPQ_SecSubjecttoCashPenaltiesQuery
Securities Penalty Reference Data Queries	SME Growth Market Query	SPQ_SMEGrowthMarketQuery
Securities Penalty Reference Data Queries	Security Penalty Rate Query	SPQ_SecurityPenaltyRateQuery
Securities Penalty Reference Data Queries	Cash Discount Penalty Rate Query	SPQ_CashDiscountPenaltyRateQuery
Securities Penalty Reference Data Queries	Daily Price Query	SPQ_DailyPriceQuery
Securities Penalty Reference Data Queries	Euro Foreign Exchange Rate Query	SPQ_EuroForeignExchangeRateQuery
Security Data Management	Create Security	SDM_CreateSecurity

Class of Privileges	Privilege Name	Privilege Short Name
Security Data Management	Update Security	SDM_UpdateSecurity
Security Data Management	Delete Security	SDM_DeleteSecurity
Security Data Management	Create Security CSD Link	SDM_CreateSecurityCSDLink
Security Data Management	Update Security CSD Link	SDM_UpdateSecurityCSDLink
Security Data Management	Delete Security CSD Link	SDM_DeleteSecurityCSDLink
Security Data Management	Create Eligible Counterpart CSD Link	SDM_CreateEligibleCounterpCSDLink
Security Data Management	Update Eligible Counterpart CSD Link	SDM_UpdateEligibleCounterpCSDLink
Security Data Management	Delete Eligible Counterpart CSD Link	SDM_DeleteEligibleCounterpCSDLink
Security Data Queries	Eligible Counterpart CSD List Query	SEQ_EligibleCounterpCSDListQuery
Security Data Queries	Eligible Counterpart CSD Details Query	SEQ_EligibleCounterpCSDDetailsQuery
Security Data Queries	Securities Reference Data Query	SEQ_SecuritiesReferDataQuery
Security Data Queries	Securities Audit Trail Query	SEQ_SecuritiesAudTrailQuery
Security Data Queries	ISIN List Query	SEQ_ISINListQuery
Security Data Queries	Securities Deviating Nominal Query	SEQ_SecuritiesDeviatNominQuery
Security Data Queries	Securities CSD Link Query	SEQ_SecuritiesCSDLinkQuery
Security Data Management	Create Auto-Collateralisation Eligibility Link	SDM_CreateAuto-ColIEligibilityLink

Class of Privileges	Privilege Name	Privilege Short Name
Security Data Management	Create Close Link	SDM_CreateCloseLink
Security Data Management	Create Securities Valuation	SDM_CreateSecuritiesValuation
Security Data Management	Delete Auto-Collateralisation Eligibility Link	SDM_DeleteAuto-CollEligibilityLink
Security Data Management	Delete Close Link	SDM_DeleteCloseLink
Security Data Queries	Auto-Collateralisation Eligibility Links Query	SEQ_Auto-CollEligibilityLinksQuery
Security Data Queries	Close Links Query	SEQ_CloseLinksQuery
Security Data Queries	Securities Valuations Query	SEQ_SecuritiesValuationsQuery
Settlement CSD	Unblock CoSD Securities Blocking related to cancelled CoSD Settlement Instructions on Behalf of the relevant CSD in T2S	SIC_USBBI
Settlement CSD	Send Settlement Instruction with non-modifiable flag activated	SIC_SINMF
Settlement CSD	CSD Hold Settlement Instruction either on a Securities Account or on Behalf of the CSD in T2S	SIC_CSDHI
Settlement CSD	Release CSD Hold Settlement Instruction either on a Securities Account or on Behalf of the CSD in T2S	SIC_RCSDH
Settlement CSD	Release CSD Validation Hold Settlement Instruction either on a Securities Account or on Behalf of the CSD in T2S	SIC_RCSDV
Settlement CSD	Release CoSD Hold Settlement Instruction on Behalf of an Administering Party	SIC_RCOSD

Class of Privileges	Privilege Name	Privilege Short Name
Settlement CSD	Amend Process Indicator of a non-modifiable Settlement Instruction on behalf of the Instructing Party of the underlying instruction	SIC_ANMBI
Settlement CSD	Hold Non-modifiable Instructions on behalf of the Instructing party of the Underlying Settlement Instruction	SIC_HNMBI
Settlement CSD	Release Non-modifiable Instructions on behalf of the Instructing party of the Underlying Settlement Instruction	SIC_RNMBI
Settlement CSD	Cancel Non-modifiable Instructions on behalf of the Instructing party of the Underlying Settlement Instruction	SIC_CNMBI
Settlement General	Send New Settlement Instruction/Settlement Restriction on Securities either on a Securities Account or on Behalf of an external CSD	SIG_SNDSI
Settlement General	Send new instruction using a specific Instructing Party	SIG_SIUIP
Settlement General	Link to an Instruction/Pool Reference belonging to a specific Party	SIG_LIPRP
Settlement General	Party Hold Settlement Instruction on a Securities Account or on Behalf of an external CSD	SIG_PTYHI
Settlement General	Release Party Hold Settlement Instruction on a Securities Account or on Behalf of an external CSD	SIG_RPTYH
Settlement General	Amend Process Indicator of a Settlement Instruction/ Settlement Restriction on Securities	SIG_AMNPI

Class of Privileges	Privilege Name	Privilege Short Name
	either on a Securities Account or on Behalf of the CSD in T2S or on Behalf of an external CSD	
Settlement General	Cancel Settlement Instruction / Settlement Restriction on Securities either on a Securities Account or on Behalf of the CSD in T2S, on Behalf on external CSD or on Behalf of an Administering Party	SIG_CANCI
Settlement ISO Codes	Use ISO Transaction Code AUTO (Auto-Collateralisation)	SII_UAUTO
Settlement ISO Codes	Use ISO Transaction Code BYIY (BuyIn)	SII_UBYIY
Settlement ISO Codes	Use ISO Transaction Code BSBK (Buy Sell Back)	SII_UBSBK
Settlement ISO Codes	Use ISO Transaction Code CLAI (Market Claim)	SII_UCLAI
Settlement ISO Codes	Use ISO Transaction Code CNCB (Central Bank Collateral Operation)	SII_UCNCB
Settlement ISO Codes	Use ISO Transaction Code COLI (Collateral In)	SII_UCOLI
Settlement ISO Codes	Use ISO Transaction Code COLO (Collateral Out)	SII_UCOLO
Settlement ISO Codes	Use ISO Transaction Code CONV (Depository Receipt Conversion)	SII_UCONV
Settlement ISO Codes	Use ISO Transaction Code CORP (Corporate Action)	SII_UCORP
Settlement ISO Codes	Use ISO Transaction Code ETFT	SII_UETFT
Settlement ISO Codes	Use ISO Transaction Code FCTA (Factor Update)	SII_UFCTA

Class of Privileges	Privilege Name	Privilege Short Name
Settlement ISO Codes	Use ISO Transaction Code INSP (Move Of Stock)	SII_UINSP
Settlement ISO Codes	Use ISO Transaction Code ISSU (Issuance)	SII_UISSU
Settlement ISO Codes	Use ISO Transaction Code MKDW (Mark Down)	SII_UMKDW
Settlement ISO Codes	Use ISO Transaction Code MKUP (Mark Up)	SII_UMKUP
Settlement ISO Codes	Use ISO Transaction Code NETT (Netting)	SII_UNETT
Settlement ISO Codes	Use ISO Transaction Code NSYN (Non Syndicated)	SII_UNSYN
Settlement ISO Codes	Use ISO Transaction Code OWNI (Internal Account Transfer)	SII_UOWNI
Settlement ISO Codes	Use ISO Transaction Code PAIR (Pair Off)	SII_UPAIR
Settlement ISO Codes	Use ISO Transaction Code PLAC (Placement)	SII_UPLAC
Settlement ISO Codes	Use ISO Transaction Code PORT (Portfolio Move)	SII_UPORT
Settlement ISO Codes	Use ISO Transaction Code REAL (Realignment)	SII_UREAL
<u>Settlement ISO Codes</u>	<u>Use ISO Transaction Code REBL (Rebalancing)</u>	<u>SII_UREBL</u> {CR-819}
Settlement ISO Codes	Use ISO Transaction Code REDI (Withdrawal)	SII_UREDI
Settlement ISO Codes	Use ISO Transaction Code REDM (Redemption)	SII_UREDM
Settlement ISO Codes	Use ISO Transaction Code RELE (Depository Receipt Release Cancellation)	SII_URELE
Settlement ISO Codes	Use ISO Transaction Code REPU (Repo)	SII_UREPU

Class of Privileges	Privilege Name	Privilege Short Name
Codes		
Settlement ISO Codes	Use ISO Transaction Code RVPO (Reverse Repurchase agreement)	SII_URVPO
Settlement ISO Codes	Use ISO Transaction Code OWNE (External Account Transfer)	SII_UOWNE
Settlement ISO Codes	Use ISO Transaction Code RODE (Return Delivery Without Matching)	SII_URODE
Settlement ISO Codes	Use ISO Transaction Code SBBK (Sell Buy Back)	SII_USBBK
Settlement ISO Codes	Use ISO Transaction Code SBRE (Borrowing Reallocation)	SII_USBRE
Settlement ISO Codes	Use ISO Transaction Code SECB (Securities Borrowing)	SII_USECB
Settlement ISO Codes	Use ISO Transaction Code SECL (Securities Lending)	SII_USECL
Settlement ISO Codes	Use ISO Transaction Code SLRE (Lending Reallocation)	SII_USLRE
Settlement ISO Codes	Use ISO Transaction Code SUBS (Subscription)	SII_USUBS
Settlement ISO Codes	Use ISO Transaction Code SWIF (Switch From)	SII_USWIF
Settlement ISO Codes	Use ISO Transaction Code SWIT (Switch To)	SII_USWIT
Settlement ISO Codes	Use ISO Transaction Code SYND (Syndicate Underwriters)	SII_USYND
Settlement ISO Codes	Use ISO Transaction Code TBAC (TBA Closing)	SII_UTBAC
Settlement ISO Codes	Use ISO Transaction Code TRAD (Trade)	SII_UTRAD
Settlement ISO Codes	Use ISO Transaction Code TRPO (Triparty Repo)	SII_UTRPO

Class of Privileges	Privilege Name	Privilege Short Name
Settlement ISO Codes	Use ISO Transaction Code TRVO (Triparty Reverse Repo)	SII_UTRVO
Settlement ISO Codes	Use ISO Transaction Code TURN (Turnaround)	SII_UTURN
Static Data Queries	Partial Settlement Threshold Query	SDQ_PartialSettl-ThresholdQuery
Static Data Queries	Country Query	SDQ_CountryQuery
Static Data Queries	Currency Query	SDQ_CurrencyQuery
Static Data Queries	Tolerance Amount Query	SDQ_Toler-anceAmountQuery
Static Data Queries	Liquidity Transfer Order of Liquidity Transfer Order Link Set Query	SDQ_LiqTranOrdOfLiqTranOrdLinkSetQ
Static Data Queries	Residual Static Data Audit Trail Query	SDQ_ResidualStat-icDataAudTrailQuery
Static Data Queries	System Entity Query	SDQ_SystemEntityQu-ery
T2S Dedicated Cash Account Data	Create Credit Memorandum Balance	DCA_CreateCredit-MemorandumBalance
T2S Dedicated Cash Account Data	Create External RTGS Account	DCA_CreateExtern-alRTGSAccount
T2S Dedicated Cash Account Data	Create Limit	DCA_CreateLimit
T2S Dedicated Cash Account Data	Create Liquidity Transfer Order	DCA_CreateLiquid-ityTransferOrder
T2S Dedicated Cash Account Data	Create Liquidity Transfer Order Link Set	DCA_CreateLiquid-ityTranOrderLinkSet
T2S Dedicated Cash Account Data	Create T2S Dedicated Cash Account	DCA_CreateT2SDed-icatedCashAccount
T2S Dedicated Cash Account Data	Delete Credit Memorandum Balance	DCA_DeleteCredit-MemorandumBalance
T2S Dedicated Cash Account Data	Delete External RTGS Account	DCA_DeleteExtern-alRTGSAccount
T2S Dedicated Cash Account Data	Delete Limit	DCA_DeleteLimit

Class of Privileges	Privilege Name	Privilege Short Name
T2S Dedicated Cash Account Data	Delete Liquidity Transfer Order	DCA_DeleteLiquidityTransferOrder
T2S Dedicated Cash Account Data	Delete Liquidity Transfer Order Link Set	DCA_DeleteLiquidityTranOrderLinkSet
T2S Dedicated Cash Account Data	Delete T2S Dedicated Cash Account	DCA_DeleteT2SDedicatedCashAccount
T2S Dedicated Cash Account Data	Update Credit Memorandum Balance	DCA_UpdateCreditMemorandumBalance
T2S Dedicated Cash Account Data	Update External RTGS Account	DCA_UpdateExternalRTGSAccount
T2S Dedicated Cash Account Data	Update Limit	DCA_UpdateLimit
T2S Dedicated Cash Account Data	Update Liquidity Transfer Order	DCA_UpdateLiquidityTransferOrder
T2S Dedicated Cash Account Data	Update Liquidity Transfer Order Link Set	DCA_UpdateLiquidityTranOrderLinkSet
T2S Dedicated Cash Account Data	Update T2S Dedicated Cash Account	DCA_UpdateT2SDedicatedCashAccount
T2S Dedicated Cash Account Data Queries	CMB Details Query	DCQ_CMBDetailsQuery
T2S Dedicated Cash Account Data Queries	CMB List Query	DCQ_CMBListQuery
T2S Dedicated Cash Account Data Queries	External RTGS Account Details Query	DCQ_ExtRTGSAccountDetailsQuery
T2S Dedicated Cash Account Data Queries	External RTGS Account List Query	DCQ_ExtRTGSAccountListQuery
T2S Dedicated Cash Account Data Queries	Limit Query	DCQ_LimitQuery
T2S Dedicated Cash Account Data Queries	Liquidity Transfer Order Detail Query	DCQ_LiquidityTransOrderDetailQuery
T2S Dedicated Cash Account Data Queries	Liquidity Transfer Order Link Set Query	DCQ_LiquidityTransOrderLinkSetQuery
T2S Dedicated Cash Account Data Queries	Liquidity Transfer Order List Query	DCQ_LiquidityTransOrderListQuery

Class of Privileges	Privilege Name	Privilege Short Name
T2S Dedicated Cash Account Data Queries	T2S Dedicated Cash Account Audit Trail Query	DCQ_T2SDedic-CashAc-cAudTrailQuery
T2S Dedicated Cash Account Data Queries	T2S Dedicated Cash Account List Query	DCQ_T2SDedicated-CashAccListQuery
T2S Dedicated Cash Account Data Queries	T2S Dedicated Cash Account Reference Data Query	DCQ_T2SDedic-CashAccRefer-DataQuery
T2S Dedicated Cash Account Data Queries	Total amount of standing and predefined orders Query	DCQ_TotAmount-Stand+Pre-defOrdQuery
Ticker Management	Create Ticker	TIC_CreateTicker
Ticker Management	Update Ticker	TIC_UpdateTicker

6.4.3 Privileges for GUI Screens for CoCos

6.4.3.1 BILL – Invoice data – Search/list screen

△ [▶ 664]

Privilege	Privilege Code	Screen Criteria
Invoice Data List Query	BIQ_Cumulative-BillDataListQuery	n/a

{Split book approach}

6.4.3.2 BILL - Invoice Data – Details Screens

△ [▶ 667]

Privilege	Privilege Code	Screen Criteria
Invoice Data Details Query	BIQ_Cumulative-BillDataDe-tailsQuery	n/a

{Split book approach}

6.4.3.3 BILL – Itemised Invoice Data - Search/List Screen

△ [▶ 671]

Privilege	Privilege Code	Screen Criteria
Itemised Invoice Data List Query	BIQ_Itemised-BillDataListQuery	n/a

{Split book approach}

6.4.3.4 BILL – Itemised Invoice Data - Details Screen

△ [▶ 674]

Privilege	Privilege Code	Screen Criteria
Itemised Invoice Data Details Query	BIQ_Itemised-BillDataDe-tailsQuery	n/a

{Split book approach}

6.4.3.5 BILL – Manual Corrections – Search/List Screen

△ [▶ 678]

Privilege	Privilege Code	Screen Criteria
Manual Correction List query	BIQ_ManualCor-rectionListQuery	n/a
Invoice Data List Query	BIQ_Cumulative-BillDataListQuery	Invoice Data

{Split book approach}

6.4.3.6 BILL – Manual Corrections – Details Screen

△ [▶ 681]

Privilege	Privilege Code	Screen Criteria
Manual Correction Details Query	BIQ_ManualCor-rectionDe-tailsQuery	Details mode
Manage Manual Correction	Bill_Manage-ManualCorrection	Add Manual Cor-rection

{Split book approach}

6.4.3.7 BILL – Manual Corrections – New/Edit Screen

△ [▶ 683]

Privilege	Privilege Code	Screen Criteria
Manage Manual Correction	BIL_Manage- ManualCorrection	New/Edit mode

{Split book approach}

6.4.3.8 BILL – PDF Invoice – Search/List Screen

△ [▶ 691]

Privilege	Privilege Code	Screen Criteria
Manage Billing Data	BIL_Manage- BillingData	n/a

{Split book approach}

6.4.4 Privileges for T2S GUI Screens

6.4.4.1 Allegement Instruction - Details Screen

△ [▶ 94]

No privileges.

6.4.4.2 Allegement Instructions - Search/List Screen

△ [▶ 90]

Privilege	Privilege Code	Privilege Type	Object Types	Screen Criteria
Allegement Query	DDQ_ Allegment Query	Object	Party	n/a

6.4.4.3 Amendment Cash Instruction - Details Screen

△ [▶ 405]

Privilege	Privilege Code	Privilege Type	Object Types	Screen Criteria
Amendment Instruction for Intra-Balance Movement Audit Trail List Query	DDQ_Am dInstrFor IntraBal MovAud TrLisQ	Object	T2S Dedic- ated Cash Account (ana- log Amend- ment Instruc-	n/a

Privilege	Privilege Code	Privilege Type	Object Types	Screen Criteria
			tion Query for Intra Balance Movements)	

6.4.4.4 Amendment Cash Instruction - New Screen

△ [▶ 410]

Privilege	Privilege Code	Privilege Type	Object Types	Screen Criteria
Link to an Instruction / Pool Reference belonging to a specific Party	SIG_LIP RP	Object	Party	Actor Reference or T2S Reference in Linkages block
Amend Process Indicator Settlement Restriction on Cash on a Dedicated Cash Account	CAM_AS RCA	Object	T2S Dedicated Cash Account	T2S Dedicated Cash Account Number
Send new instruction using a specific Instructing Party	SIG_SIU IP	Object	Party	n/a

6.4.4.5 Amendment Securities Instruction - Details Screen

△ [▶ 98]

Privilege	Privilege Code	Privilege Type	Object Types	Screen Criteria
Amendment Instruction for Intra-Position Movement or Settlement Instruction Audit Trail List Query	DDQ_Am dInsIntrP osMovSet InsAud TrLisQ	Object	Securities Account	n/a

6.4.4.6 Amendment Securities Instruction - New Screen

△ [▶ 103]

Privilege	Privilege Code	Privilege Type	Object Types	Screen Criteria
Send new instruction using a specific Instructing Party	SIG_SIU IP	Object	Party	n/a
Link to an Instruction / Pool Reference belonging to a specific Party	SIG_LIP RP	Object	Party	Actor Reference or T2S Reference in Linkages block
Amend Process Indicator of a Settlement Instruction/Settlement Restriction on Securities either on a Securities Accountor or on Behalf of the CSD in T2S or on Behalf of an external CSD	SIG_AM NPI	Object	Party Securities Account	n/a
Amend Process Indicator of a non-modifiable Settlement Instruction on behalf of the Instructing Party of the underlying instruction	SIC_AN MBI	Object	Party	n/a

6.4.4.7 Available Report - Current Settlement Day Cash Information (Following Settlement Day Cash Forecast) Report - Details Screen

△ [▶ 459]

Privilege	Privilege Code	Privilege Type	Object Types	Screen Criteria
Report Details Query	RCO_ Report Details Query	System	n/a	n/a

6.4.4.8 Available Report - Details Screen

△ [▶ 457]

Privilege	Privilege Code	Privilege Type	Object Types	Screen Criteria
Report Details Query	RCO_Report Details Query	System	n/a	n/a
Report List Query	RCO_Report ListQuery	System	n/a	n/a

6.4.4.9 Available Report - Statement of Accounts - Details Screen

△ [▶ 464]

Privilege	Privilege Code	Privilege Type	Object Types	Screen Criteria
Report Details Query	RCO_Report Details Query	System	n/a	n/a

6.4.4.10 Available Report - Statement of Executed Amendment Instructions for Intra-Balance Movements - Details Screen

△ [▶ 467]

Privilege	Privilege Code	Privilege Type	Object Types	Screen Criteria
Report Details Query	RCO_Report Details Query	System	n/a	n/a

6.4.4.11 Available Report - Statement of Executed Amendment Instructions for Intra-Position Movements and Settlement Instructions - Details Screen

△ [▶ 472]

Privilege	Privilege Code	Privilege Type	Object Types	Screen Criteria
Report Details Query	RCO_ Report Details Query	System	n/a	n/a

6.4.4.12 Available Report - Statement of Executed Cancellation Instructions for Intra-Balance Movements - Details Screen

△ [▶ 481]

Privilege	Privilege Code	Privilege Type	Object Types	Screen Criteria
Report Details Query	RCO_ Report Details Query	System	n/a	n/a

6.4.4.13 Available Report - Statement of Executed Cancellation Instructions for Intra-Position Movements and Settlement Instructions - Details Screen

△ [▶ 485]

Privilege	Privilege Code	Privilege Type	Object Types	Screen Criteria
Report Details Query	RCO_ Report Details Query	System	n/a	n/a

6.4.4.14 Available Report - Statement of Holdings - Details Screen

△ [▶ 493]

Privilege	Privilege Code	Privilege Type	Object Types	Screen Criteria
Report Details Query	RCO_ Report Details Query	System	n/a	n/a

6.4.4.15 Available Report - Statement of Pending Amendment Instructions for Intra-Balance Movements - Details Screen

△ [▶ 498]

Privilege	Privilege Code	Privilege Type	Object Types	Screen Criteria
Report Details Query	RCO_ Report Details Query	System	n/a	n/a

6.4.4.16 Available Report - Statement of Pending Amendment Instructions for Intra-Position Movements and Settlement Instructions - Details Screen

△ [▶ 503]

Privilege	Privilege Code	Privilege Type	Object Types	Screen Criteria
Report Details Query	RCO_ Report Details Query	System	n/a	n/a

6.4.4.17 Available Report - Statement of Pending Cancellation Instructions for Intra-Balance Movements - Details Screen

△ [▶ 512]

Privilege	Privilege Code	Privilege Type	Object Types	Screen Criteria
Report Details Query	RCO_ Report Details Query	System	n/a	n/a

6.4.4.18 Available Report - Statement of Pending Cancellation Instructions for Intra-Position Movements and Settlement Instructions - Details Screen

△ [▶ 516]

Privilege	Privilege Code	Privilege Type	Object Types	Screen Criteria
Report Details Query	RCO_ Report Details Query	System	n/a	n/a

6.4.4.19 Available Report - Statement of Pending Instructions - Details Screen

△ [▶ 524]

Privilege	Privilege Code	Privilege Type	Object Types	Screen Criteria
Report Details Query	RCO_ Report Details Query	System	n/a	n/a

6.4.4.20 Available Report - Statement of Pending Intra-Balance Movements - Details Screen

△ [▶ 533]

Privilege	Privilege Code	Privilege Type	Object Types	Screen Criteria
Report Details Query	RCO_ Report Details Query	System	n/a	n/a

6.4.4.21 Available Report - Statement of Pending Intra-Position Movements - Details Screen

△ [▶ 538]

Privilege	Privilege Code	Privilege Type	Object Types	Screen Criteria
Report Details Query	RCO_ Report Details Query	System	n/a	n/a

6.4.4.22 Available Report - Statement of Settled Intra-Balance Movements - Details Screen

△ [▶ 543]

Privilege	Privilege Code	Privilege Type	Object Types	Screen Criteria
Report Details Query	RCO_ Report Details Query	System	n/a	n/a

6.4.4.23 Available Report - Statement of Settled Intra-Position Movements - Details Screen

△ [▶ 548]

Privilege	Privilege Code	Privilege Type	Object Types	Screen Criteria
Report Details Query	RCO_ Report Details Query	System	n/a	n/a

6.4.4.24 Available Report - Statement of Settlement Allegements - Details Screen

△ [▶ 551]

Privilege	Privilege Code	Privilege Type	Object Types	Screen Criteria
Report Details Query	RCO_Report Details Query	System	n/a	n/a

6.4.4.25 Available Report - Statement of Transactions - Details Screen

△ [▶ 564]

Privilege	Privilege Code	Privilege Type	Object Types	Screen Criteria
Report Details Query	RCO_Report Details Query	System	n/a	n/a

6.4.4.26 Available Reports - Search/List Screen

△ [▶ 452]

Privilege	Privilege Code	Privilege Type	Object Types	Screen Criteria
Report List Query	RCO_Report ListQuery	System	n/a	n/a

6.4.4.27 Available Reports – Daily Penalty List – Details Screen

△

Privilege	Privilege Code	Privilege Type	Object Types	Screen Criteria
Report Details Query	RCO_Report Details Query	System	n/a	n/a

6.4.4.28 Available Reports – List of Modified Penalties – Details Screen

△

Privilege	Privilege Code	Privilege Type	Object Types	Screen Criteria
Report Details Query	RCO_ Report Details Query	System	n/a	n/a

6.4.4.29 Available Reports – Monthly Aggregated Amounts – Details Screen

△

Privilege	Privilege Code	Privilege Type	Object Types	Screen Criteria
Report Details Query	RCO_ Report Details Query	System	n/a	n/a

6.4.4.30 Broadcast - Details Screen

△ [▶ 620]

Privilege	Privilege Code	Privilege Type	Object Types	Screen Criteria
Broadcast Query	DDQ_ Broad cast Query	System	n/a	n/a

6.4.4.31 Broadcast - New Screen

△ [▶ 622]

Privilege	Privilege Code	Privilege Type	Object Types	Screen Criteria
New Broadcast	MMA_ New Broad cast	System	n/a	n/a

6.4.4.32 Broadcasts - Search/List Screen

△ [▶ 617]

Privilege	Privilege Code	Privilege Type	Object Types	Screen Criteria
Broadcast Query	DDQ_ Broad cast Query	System	n/a	n/a
New Broadcast	MMA_ New Broad cast	System	n/a	n/a

6.4.4.33 Calender - Details Screen

△ [▶ 702]

Privilege	Privilege Code	Privilege Type	Object Types	Screen Criteria
T2S calendar query	SCQT2S- Calender- Query	System	n/a	n/a

6.4.4.34 Cancellation Cash Instruction - Details Screen

△ [▶ 417]

Privilege	Privilege Code	Privilege Type	Object Types	Screen Criteria
Cancellation Instruction for Intra-Balance Movement Audit Trail Details Query	DDQ_ CanclInstr IntraBala nMovAud TrDetQ	Object	T2S Dedic- ated Cash Account (ana- log Cancell- ation Instruc-	Transactional Data Object Type

Privilege	Privilege Code	Privilege Type	Object Types	Screen Criteria
			tions for Intra Balance Movements Query)	

6.4.4.35 Cancellation Cash Instruction - New Screen

△ [▶ 420]

Privilege	Privilege Code	Privilege Type	Object Types	Screen Criteria
Send new instruction using a specific Instructing Party	SIG_SIU IP	Object	Party	n/a
Cancel Settlement Restriction on Cash on a Dedicated Cash Account	CAM_CS RCA	Object	T2S Dedicated Cash Account	T2S Dedicated Cash Account

6.4.4.36 Cancellation Securities Instruction - Details Screen

△ [▶ 113]

Privilege	Privilege Code	Privilege Type	Object Types	Screen Criteria
Cancellation Instruction for Intra-Position Movement or Settlement Instruction Audit Trail List Query	DDQ_ CanclInst rIntraPo sMovAud TrLisQ	Object	Securities Account	n/a

6.4.4.37 Cancellation Securities Instruction - New Screen

△ [▶ 117]

Privilege	Privilege Code	Privilege Type	Object Types	Screen Criteria
Send new instruction using a specific Instructing Party	SIG_SIU IP	Object	Party	n/a
Cancel Settlement Instruction / Settlement Restriction on Securities either on a Securities Account or on Behalf of the CSD in T2S, on Behalf on external CSD or on Behalf of an Administering Party	SIG_CA NCI	Object	Party Securities Account	n/a
Cancel Non-modifiable Instructions on behalf of the Instructing party of the Underlying Settlement Instruction	SIC_CN MBI	Object	Party	n/a

6.4.4.38 Cash Forecast - Details Screen

△ [▶ 332]

No privileges.

6.4.4.39 Cash Forecasts - Search/List Screen

△ [▶ 324]

Privilege	Privilege Code	Privilege Type	Object Types	Screen Criteria
Cash Forecast Query	DDQ_ Cash Forecast Query	Object	Party	n/a

6.4.4.40 Cash Restriction Details - Search/List Screen

△ [▶ 338]

Privilege	Privilege Code	Privilege Type	Object Types	Screen Criteria
T2S Dedicated Cash Account Balance Detailed Restrictions Query	DDQ_T2S DCABalan Detailed Restrict Query	Object	T2S Dedicated Cash Account	n/a

6.4.4.41 Collateral Value of a Security - Search/List Screen

△ [▶ 341]

Privilege	Privilege Code	Privilege Type	Object Types	Screen Criteria
Collateral Value of a Security Query	DDQ_ Collat Value-of- Security Query	System	n/a	n/a

6.4.4.42 Collateral Value per T2S Dedicated Cash Account and Security - Search/List Screen

△ [▶ 345]

Privilege	Privilege Code	Privilege Type	Object Types	Screen Criteria
Collateral Value per T2S Dedicated Cash Account Query	DDQ_ Collat ValuePer T2SDCA Query	System	n/a	n/a

6.4.4.43 Settlement Day - Search/List Screen

△

Privilege	Privilege Code	Privilege Type	Object Types	Screen Criteria
Cumulative Billing Data List	BIQ_ Cumula	Object	Party	n/a

Privilege	Privilege Code	Privilege Type	Object Types	Screen Criteria
	tiveBill DataList Query			
Cumulative Billing Data	BIQ_ Cumulat- ive Bill Data-De- tails Query	Object	Party	n/a

6.4.4.44 Data Change - Details Screen

△ [▶ 612]

Privilege	Privilege Code	Privilege Type	Object Types	Screen Criteria
Data Changes of a Business Object List Query	DDQ_ Data Chan- Business ObjList Query	System	n/a	n/a
Data Changes of a Business Object Details Query	DDQ_ Data Chan- Business ObjDetail Query	System	n/a	n/a

6.4.4.45 Data Changes - Search/List Screen

△ [▶ 608]

Privilege	Privilege Code	Privilege Type	Object Types	Screen Criteria
Data Changes of a Business Object List Query	DDQ_DataChan-BusinessObjListQuery	System	n/a	n/a
Data Changes of a Business Object Details Query	DDQ_DataChan-BusinessObjDetailQuery	System	n/a	n/a

6.4.4.46 Hold/Release Instruction - Details Screen

△ [▶ 122]

Privilege	Privilege Code	Privilege Type	Object Types	Screen Criteria
Hold/Release Instruction Audit Trail List Query	DDQ_HoldReleaseInstrAuditTrailListQuery	Object	Securities Account (analog Hold/Release Instruction Query)	n/a

6.4.4.47 Hold/Release Instruction - New Screen

△ [▶ 126]

Privilege	Privilege Code	Privilege Type	Object Types	Screen Criteria
Party Hold Settlement Instruction on a Securities Account or on Behalf of an external CSD	SIG_PTYHI	Object	Party Securities Account	Party Hold (flagged)

Privilege	Privilege Code	Privilege Type	Object Types	Screen Criteria
CSD Hold Settlement Instruction either on a Securities Account or on Behalf of the CSD in T2S	SIC_CS DHI	Object	Securities Account/Party	CSD Hold (flagged)
Release Party Hold Settlement Instruction on a Securities Account or on Behalf of an external CSD	SIG_RP TYH	Object	Securities Account/Party	Party Release (flagged)
Release Party Hold Auto-collateralisation Instruction on a Securities Account	SIG_RP TYA	Object	Securities Account/Party	Party Release (flagged)
Release CSD Hold Settlement Instruction either on a Securities Account or on Behalf of the CSD in T2S	SIC_RC SDH	Object	Securities Account/Party	CSD Release (flagged)
Release CSD Validation Hold Settlement Instruction either on a Securities Account or on Behalf of the CSD in T2S	SIC_RC SDV	Object	Securities Account/Party	CSD Validation Release (flagged)
Release CoSD Hold Settlement Instruction on Behalf of an Administering Party	SIC_RC OSD	Object	Party	CoSD Release (flagged)
Hold Non-modifiable Instructions on behalf of the Instructing party of the Underlying Settlement Instruction	SIC_HN MBI	Object	Party	n/a

Privilege	Privilege Code	Privilege Type	Object Types	Screen Criteria
Release Non-modifiable Instructions on behalf of the Instructing party of the Underlying Settlement Instruction	SIC_RN MBI	Object	Party	n/a

6.4.4.48 Immediate Liquidity Transfer Order - New Screen

△ [▶ 387]

Privilege	Privilege Code	Privilege Type	Object Types	Screen Criteria
Send New Liquidity Transfer	CAM_ Send New Liquidity Transfer	Object	Party T2S Dedic- ated Cash Account	n/a

6.4.4.49 Immediate Liquidity Transfer Order- Details Screen

△ [▶ 382]

Privilege	Privilege Code	Privilege Type	Object Types	Screen Criteria
Immediate Liquidity Transfer Order Detail Query	DDQ_ ImmedLiq uidTrans OrderDet Query	Object	T2S Dedic- ated Cash Account	n/a
Immediate Liquidity Transfer Order Audit Trail List Query	DDQ_ ImmedLiq uidTrans OrderAud TrListQ	Object	T2S Dedic- ated Cash Account	n/a

6.4.4.50 Immediate Liquidity Transfer Orders - Search/List Screen

△ [▶ 374]

Privilege	Privilege Code	Privilege Type	Object Types	Screen Criteria
Immediate Liquidity Transfer Order List Query	DDQ_ImmedLiquidTransOrderListQuery	Object	T2S Dedicated Cash Account	n/a
Immediate Liquidity Transfer Order Detail Query	DDQ_ImmedLiquidTransOrderDetQuery	Object	T2S Dedicated Cash Account	n/a

6.4.4.51 Inbound File - Details Screen

△ [▶ 626]

Privilege	Privilege Code	Privilege Type	Object Types	Screen Criteria
Inbound Files Details Query	DDQ_InboundFilesDetailsQuery	System	n/a	n/a

6.4.4.52 Inbound Files - Search/List Screen

△ [▶ 623]

Privilege	Privilege Code	Privilege Type	Object Types	Screen Criteria
Inbound Files List Query	DDQ_InboundFilesListQuery	System	n/a	n/a

6.4.4.53 Inbound Message - Details Screen

△ [▶ 636]

Privilege	Privilege Code	Privilege Type	Object Types	Screen Criteria
Inbound Message Details Query	DDQ_InboundMessDetailsQuery	System	n/a	n/a

6.4.4.54 Inbound Messages - Search/List Screen

△ [▶ 629]

Privilege	Privilege Code	Privilege Type	Object Types	Screen Criteria
Inbound Message List Query	DDQ_InboundMessListQuery	System	n/a	n/a

6.4.4.55 Insolvency procedure Settlement Instructions - Search/List Screen

△ [▶ 270]

Privilege	Privilege Code	Privilege Type	Object Types	Screen Criteria
Settlement Instruction Matched and Accepted Status Query Privilege	DDQ_SettlementInstructionMatchAcceptedStatusQuery	Object	Securities Account, Party	n/a

6.4.4.56 Intra-Balance Movement - Details Screen

△ [▶ 430]

Privilege	Privilege Code	Privilege Type	Object Types	Screen Criteria
Intra-Balance Movement Audit Trail List Query	DDQ_IntraBalanceMov	Object	T2S Dedicated Cash Account	n/a

Privilege	Privilege Code	Privilege Type	Object Types	Screen Criteria
	Audit TrailLis Query			

6.4.4.57 Intra-Balance Movement - New Screen

△ [▶ 437]

Privilege	Privilege Code	Privilege Type	Object Types	Screen Criteria
Send New Settlement Restriction on Cash on a Dedicated Cash Account	CAM_SN DRC	Object	T2S Dedicated Cash Account	Dedicated Cash Account Number (just for the object)
Unblock CoSD Cash Blocking related to cancelled CoSD Settlement Instructions on Behalf of the relevant CSD in T2S	CAM_UC BBI	Object	Party	n/a
Link to an Instruction/ Pool Reference belonging to a specific Party	SIG_LIP RP	Object	Party	Actor Reference or T2S Reference in Linkages block
Send new instruction using a specific Instructing Party	SIG_SIU IP	Object	Party	n/a

6.4.4.58 Intra-Balance Movements - Search/List Screen

△ [▶ 423]

Privilege	Privilege Code	Privilege Type	Object Types	Screen Criteria
Intra-Balance Movements Query	DDQ_IntraBalanceMovQuery	Object	T2S Dedicated Cash Account	n/a

6.4.4.59 Intra-Position Movement - Details Screen

△ [▶ 144]

Privilege	Privilege Code	Privilege Type	Object Types	Screen Criteria
Intra-Position Movements Query	DDQ_IntraPosMovQuery	Object	Securities Account	n/a

6.4.4.60 Intra-Position Movement - New Screen

△ [▶ 151]

Privilege	Privilege Code	Privilege Type	Object Types	Screen Criteria
Send New Settlement Instruction/Settlement Restriction on Securities either on a Securities Account or on Behalf of an external CSD	SIG_SN DSI	Object	Securities Account	Securities Account (just for the object)
Unblock CoSD Securities Blocking related to cancelled CoSD Settlement Instructions on Behalf of the relevant CSD in T2S	SIC_US BBI	Object	Party	n/a
Link to an Instruction / Pool Reference belonging to a specific Party	SIG_LIP RP	Object	Party	Actor Reference or T2S Reference in Linkages block
Send new instruction using a specific Instructing Party	SIG_SIU IP	Object	Party	n/a

6.4.4.61 Intra-Position Movements - Search/List Screen

△ [▶ 137]

Privilege	Privilege Code	Privilege Type	Object Types	Screen Criteria
Intra-Position Movements Query	DDQ_Int raPosMov Query	Object	Securities Ac- count	n/a

6.4.4.62 Limit Utilisation - Search/List Screen

△ [▶ 349]

Privilege	Privilege Code	Privilege Type	Object Types	Screen Criteria
Limit Utilisation Query	DDQ_ LimitUti lisation Query	System	n/a	n/a

6.4.4.63 Limit Utilisation Journal - Search/List Screen

△ [▶ 353]

Privilege	Privilege Code	Privilege Type	Object Types	Screen Criteria
Limit Utilisation Journal Query	DDQ_ LimitUti lisation Journal Query	System	n/a	n/a

6.4.4.64 Maintenance Cash Instructions – Search/List Screen

△ [▶ 448]

Privilege	Privilege Code	Privilege Type	Object Types	Screen Criteria
Cancellation Instructions for Intra-Balance Movements Query	DDQ_ CanclInstr Intra BalanMov Query	Object	T2S Dedic- ated Cash Account	'Maintenance In- struction Type'. Mandatory field that identify the kind of Mainte- nance Instruction queried.
Maintenance Instruc- tion for Intra-Balance Movements Query	DDQ_ Maint InstrFor IntraBa lanMov Quer	Object	T2S Dedic- ated Cash Account	'Maintenance In- struction Type'. Mandatory field that identify the kind of Mainte- nance Instruction queried.
Amendment Instruction Query for Intra-Balance Movements	DDQ_ Amend Instr Query ForIntra BalanMov	Object	T2S Dedic- ated Cash Account	'Maintenance In- struction Type'. Mandatory field that identify the kind of Mainte- nance Instruction queried.

6.4.4.65 Maintenance Securities Instructions – Search/ List Screen

△ [▶ 164]

Privilege	Privilege Code	Privilege Type	Object Types	Screen Criteria
Cancellation Instruction Query for Intra-Position Movements and Settle- ment Instructions	DDQ_ CanclInstr ForSI+Int raPosMov Query	Object	Securities Ac- count	'Maintenance In- struction Type' Mandatory field that identify the kind of Mainte- nance Instruction queried.

Privilege	Privilege Code	Privilege Type	Object Types	Screen Criteria
Maintenance for Intra-Position Movements and Settlement Instructions Query	DDQ_MaintForIntraPosMov+SettlInstrQ	Object	Securities Account	'Maintenance Instruction Type' Mandatory field that identify the kind of Maintenance Instruction queried.
Amendment Instruction Query for Intra-Position Movements and Settlement Instructions	DDQ_AmendInstrQIntraPosMov+SetInstr	Object	Securities Account	'Maintenance Instruction Type' Mandatory field that identify the kind of Maintenance Instruction queried.

6.4.4.66 Outbound File - Details Screen

△ [▶ 644]

Privilege	Privilege Code	Privilege Type	Object Types	Screen Criteria
Outbound Files Details Query	DDQ_OutboundFilesDetailsQuery	System	n/a	n/a
Resend Communication	MMA_ResendCommunication	Object	Party	'Resend' button

6.4.4.67 Outbound Files - Search/List Screen

△ [▶ 641]

Privilege	Privilege Code	Privilege Type	Object Types	Screen Criteria
Outbound Files List Query	DDQ_OutboundFilesListQuery	System	n/a	n/a

Privilege	Privilege Code	Privilege Type	Object Types	Screen Criteria
Outbound Files Details Query	DDQ_ Outbound Files Details Query	System	n/a	n/a
Resend Communication	MMA_ Resend Communi- cation	Object	Party	'Resend' button

6.4.4.68 Outbound Message - Details Screen

△ [▶ 654]

Privilege	Privilege Code	Privilege Type	Object Types	Screen Criteria
Outbound Message Details Query	DDQ_ Outbound MessDet ailsQuery	System	n/a	n/a
Resend Communication	MMA_ Resend Communi- cation	Object	Party	'Resend' button

6.4.4.69 Outbound Messages - Search/List Screen

△ [▶ 646]

Privilege	Privilege Code	Privilege Type	Object Types	Screen Criteria
Outbound Message List Query	DDQ_ Outbound MessList Query	System	n/a	n/a
Outbound Message Details Query	DDQ_ Outbound Mess Details Query	System	n/a	n/a

Privilege	Privilege Code	Privilege Type	Object Types	Screen Criteria
Resend Communication	MMA_Resend Communication	Object	Party	'Resend' button

6.4.4.70 Outstanding Auto-Collateralisation Credits - Search/List Screen

△ [▶ 393]

Privilege	Privilege Code	Privilege Type	Object Types	Screen Criteria
Outstanding Auto-Collateralisation Credit Query	DDQ_Outstand Auto-Coll Credit Query	System	n/a	n/a

6.4.4.71 Overall Liquidity - Search/List Screen

△ [▶ 397]

Privilege	Privilege Code	Privilege Type	Object Types	Screen Criteria
T2S Overall Liquidity Query	DDQ_T2S Overall Liquidity Query	Object	Party	n/a

6.4.4.72 Penalty – Search/List Screen

△

Privilege	Privilege Code	Privilege Type	Object Types	Screen Criteria
Penalty List Query Privilege	SPQ_PenaltyListQuery	System	n/a	n/a

Privilege	Privilege Code	Privilege Type	Object Types	Screen Criteria
Settlement Instruction Audit Trail Query	DDQ_Set- t- tllInstruct A uit_Trail Query	Object	Securities Ac- count Party	n/a

6.4.4.73 Penalty – Details Screen

△

Privilege	Privilege Code	Privilege Type	Object Types	Screen Criteria
Penalty Details Query	SPQ_Pe naltyDe- tailsQuer y	System	n/a	n/a

6.4.4.74 Monthly Net Penalty Amounts – Search/List Screen

△

Privilege	Privilege Code	Privilege Type	Object Types	Screen Criteria
Monthly Net Amount Query	SPQ_Mo ntlyNet- Pen- altyAmou ntQuery	System	n/a	n/a

6.4.4.75 Penalty Removal Screen

△

Privilege	Privilege Code	Privilege Type	Object Types	Screen Criteria
Modification of penalties	SEP_Mo dific- tionOfPe nalties	System	n/a	Edit mode

Privilege	Privilege Code	Privilege Type	Object Types	Screen Criteria
Settlement Instruction Audit Trail Query	Securities Account Party	n/a	Securities Account Party	n/a

6.4.4.76 Penalty Re-allocation Screen

△

Privilege	Privilege Code	Privilege Type	Object Types	Screen Criteria
Modification of penalties	SEP_ModificationOfPenalties	System	n/a	Edit mode
Settlement Instruction Audit Trail Query	Securities Account Party	n/a	Securities Account Party	n/a

6.4.4.77 Penalty Switch Screen

△

Privilege	Privilege Code	Privilege Type	Object Types	Screen Criteria
Modification of penalties	SEP_ModificationOfPenalties	System	n/a	Edit mode
Settlement Instruction Audit Trail Query	Securities Account Party	n/a	Securities Account Party	n/a

6.4.4.78 Resend Communication Screen

△ [▶ 658]

Privilege	Privilege Code	Privilege Type	Object Types	Screen Criteria
Resend Communication	MMA_ResendCommunication	Object	Party	n/a

6.4.4.79 Revisions/Audit Trail - List Screen

△ [▶ 662]

Privilege	Privilege Code	Privilege Type	Object Types	Screen Criteria
Amendment Instruction for Intra-Position Movement or Settlement Instruction Audit Trail List Query	DDQ_Am-dInsIntr-PosMov-SetIn-sAudTrL-isQ	Object	Securities Account	n/a
Amendment Instruction for Intra-Balance Movement Audit Trail List Query	DDQ_Am-dInstrFor-IntraBal-MovAudTrLisQ	Object	T2S Dedicated Cash Account	n/a
Cancellation Instruction for Intra-Balance Movement Audit Trail List Query	DDQ_Can-clnstrIntra-Balan-MovAudTrLisQ	Object	Securities Account	n/a
Cancellation Instruction for Intra-Position Movement or Settlement Instruction Audit Trail List Query	DDQ_Can-clnstrIntra-Pos-MovAudTrLisQ	Object	T2S Dedicated Cash Account	n/a
Immediate Liquidity Transfer Order Audit Trail List Query	DDQ_Imm-edLi-liquidTransOrderAudTrListQ	Object	T2S Dedicated Cash Account	n/a

Privilege	Privilege Code	Privilege Type	Object Types	Screen Criteria
Intra-Balance Movement Audit Trail List Query	DDQ_IntraBalan-MovAudit-Trail-LisQuery	Object	T2S Dedicated Cash Account	n/a
Intra-Position Movement Audit Trail List Query	DDQ_IntraPos-MovAudit-Trail-ListQuery	Object	Securities Account	n/a
Party Audit Trail Query	PDQ_PartyAud Trail Query	Object	Party	Object Type = Party
Securities Account Audit Trail Query	SAQ_SecuritiesAcc AudTrail Query	Object	Securities Account	Object Type = Securities Account
Securities Audit Trail Query	SEQ_SecuritiesAud Trail Query	Object	Security	Object Type = Securities
Settlement Instruction Audit Trail Query	DDQ_SettlInstructAuit-TrailQuery	Object	Securities Account Party	n/a
T2S Dedicated Cash Account Audit Trail Query	DCQ_T2S Dedic CashAcc AudTrail Query	Object	T2S Dedicated Cash Account	Object Type = T2S Dedicated Cash Account

Privilege	Privilege Code	Privilege Type	Object Types	Screen Criteria
Residual Static Data Audit Trail Query	SDQ_Residual Static Data Audit Trail Query	System	n/a	Object Type is not Party, T2S Dedicated Cash Account, Securities or Securities Account

6.4.4.80 Securities Position - Details Screen

△ [▶ 174]

No privileges.

6.4.4.81 Securities Positions - Search/List Screen

△ [▶ 169]

Privilege	Privilege Code	Privilege Type	Object Types	Screen Criteria
Securities Account Position Query	DDQ_Securities Account Position Query	Object	Securities Account	n/a

6.4.4.82 Securities Postings - Search/List Screen

△ [▶ 82]

Privilege	Privilege Code	Privilege Type	Object Types	Screen Criteria
Securities Posting Query	DDQ_Securities Posting Query	Object	Securities Account	n/a

6.4.4.83 Securities Restriction Details - Search/List Screen

△ [▶ 86]

Privilege	Privilege Code	Privilege Type	Object Types	Screen Criteria
Securities Position Detailed Restriction Details Query	DDQ_SecurPosDetailedRestrDetailsQue	Object	Securities Account	n/a

6.4.4.84 Settlement Instruction - Details Screen

△ [▶ 192]

Privilege	Privilege Code	Privilege Type	Object Types	Screen Criteria
Settlement Instruction Query	DDQ_SettlInstructQuery	Object	Securities Account, Party	n/a

6.4.4.85 Settlement Instruction - New Screen

△

Privilege	Privilege Code	Privilege Type	Object Types	Screen Criteria
Send New Settlement Instruction/Settlement Restriction on Securities either on a Securities Account or on Behalf of an external CSD	SIG_SNDSI	Object	Securities Account Party	Securities Account (just for the object)
Send Settlement Instruction with non-modifiable flag activated	SIC_SINMF	System	n/a	Allowed Modification Flag= No

Privilege	Privilege Code	Privilege Type	Object Types	Screen Criteria
Link to an Instruction / Pool Reference belonging to a specific Party	SIG_LIP RP	Object	Party	Actor Reference or T2S Reference in Linkages block
Party Hold Settlement Instruction on a Securities Account or on Behalf of an external CSD	SIG_PTY HI	Object	Securities Account Party	Party Hold (flagged)
CSD Hold Settlement Instruction either on a Securities Account or on Behalf of the CSD in T2S	SIC_CS DHI	Object	Securities Account Party	CSD Hold (flagged)
Use ISO Transaction Code AUTO (Auto-Collateralisation)	SII_UAU TO	System	n/a	Securities Transaction Type
Use ISO Transaction Code BYIY (BuyIn)	SII_UBYI Y	System	n/a	Securities Transaction Type
Use ISO Transaction Code BSBK (Buy Sell Back)	SII_UBS BK	System	n/a	Securities Transaction Type
Use ISO Transaction Code CLAI (Market Claim)	SII_UCL AI	System	n/a	Securities Transaction Type
Use ISO Transaction Code CNCB (Central Bank Collateral Operation)	SII_UCN CB	System	n/a	Securities Transaction Type
Use ISO Transaction Code COLI (Collateral In)	SII_UCO LI	System	n/a	Securities Transaction Type
Use ISO Transaction Code COLO (Collateral Out)	SII_UCO LO	System	n/a	Securities Transaction Type

Privilege	Privilege Code	Privilege Type	Object Types	Screen Criteria
Use ISO Transaction Code CONV (Depository Receipt Conversion)	SII_UCO NV	System	n/a	Securities Transaction Type
Use ISO Transaction Code CORP (Corporate Action)	SII_UCO RP	System	n/a	Securities Transaction Type
Use ISO Transaction Code ETFT (Exchange Traded Funds)	SII_UET FT	System	n/a	Securities Transaction Type
Use ISO Transaction Code FCTA (Factor Update)	SII_UFC TA	System	n/a	Securities Transaction Type
Use ISO Transaction Code INSP (Move Of Stock)	SII_UIN SP	System	n/a	Securities Transaction Type
Use ISO Transaction Code ISSU (Issuance)	SII_UIS SU	System	n/a	Securities Transaction Type
Use ISO Transaction Code MKDW (Mark Down)	SII_UMK DW	System	n/a	Securities Transaction Type
Use ISO Transaction Code MKUP (Mark Up)	SII_UMK UP	System	n/a	Securities Transaction Type
Use ISO Transaction Code NETT (Netting)	SII_UNE TT	System	n/a	Securities Transaction Type
Use ISO Transaction Code NSYN (Non Syndicated)	SII_UNS YN	System	n/a	Securities Transaction Type
Use ISO Transaction Code OWNE (External Account Transfer)	SII_UOW NE	System	n/a	Securities Transaction Type
Use ISO Transaction Code OWNI (Internal Account Transfer)	SII_UOW NI	System	n/a	Securities Transaction Type
Use ISO Transaction Code PAIR (Pair Off)	SII_UPA IR	System	n/a	Securities Transaction Type

Privilege	Privilege Code	Privilege Type	Object Types	Screen Criteria
Use ISO Transaction Code PLAC (Placement)	SII_UPLAC	System	n/a	Securities Transaction Type
Use ISO Transaction Code PORT (Portfolio Move)	SII_UPORT	System	n/a	Securities Transaction Type
Use ISO Transaction Code REAL (Realignment)	SII_UREAL	System	n/a	Securities Transaction Type
Use ISO Transaction Code REDI (Withdrawal)	SII_UREDI	System	n/a	Securities Transaction Type
Use ISO Transaction Code REDM (Redemption)	SII_UREDM	System	n/a	Securities Transaction Type
Use ISO Transaction Code RELE (Depository Receipt Release Cancellation)	SII_URELE	System	n/a	Securities Transaction Type
Use ISO Transaction Code REPU (Repo)	SII_UREPU	System	n/a	Securities Transaction Type
Use ISO Transaction Code RODE (Return Delivery Without Matching)	SII_URODE	System	n/a	Securities Transaction Type
Use ISO Transaction Code RVPO (Reverse Repurchase agreement)	SII_URVPO	System	n/a	Securities Transaction Type
Use ISO Transaction Code SBBK (Sell Buy Back)	SII_USBK	System	n/a	Securities Transaction Type
Use ISO Transaction Code SBRE (Borrowing Reallocation)	SII_USBRE	System	n/a	Securities Transaction Type

Privilege	Privilege Code	Privilege Type	Object Types	Screen Criteria
Use ISO Transaction Code SECB (Securities Borrowing)	SII_USE CB	System	n/a	Securities Transaction Type
Use ISO Transaction Code SECL (Securities Lending)	SII_USE CL	System	n/a	Securities Transaction Type
Use ISO Transaction Code SLRE (Lending Reallocation)	SII_USL RE	System	n/a	Securities Transaction Type
Use ISO Transaction Code SUBS (Subscription)	SII_USU BS	System	n/a	Securities Transaction Type
Use ISO Transaction Code SWIF (Switch From)	SII_USWI F	System	n/a	Securities Transaction Type
Use ISO Transaction Code SWIT (Switch To)	SII_USWI T	System	n/a	Securities Transaction Type
Use ISO Transaction Code SYND (Syndicate Underwriters)	SII_USY ND	System	n/a	Securities Transaction Type
Use ISO Transaction Code TBAC (TBA Closing)	SII_UTB AC	System	n/a	Securities Transaction Type
Use ISO Transaction Code TRAD (Trade)	SII_UTR AD	System	n/a	Securities Transaction Type
Use ISO Transaction Code TRPO (Triparty Repo)	SII_UTR PO	System	n/a	Securities Transaction Type
Use ISO Transaction Code TRVO (Triparty Reverse Repo)	SII_UTR VO	System	n/a	Securities Transaction Type
Use ISO Transaction Code TURN (Turn-around)	SII_UTU RN	System	n/a	Securities Transaction Type
Send new instruction using a specific Instructing Party	SIG_SIU IP	Object	Party	n/a

6.4.4.86 Settlement Instructions - Search/List Screen

△ [▶ 177]

Privilege	Privilege Code	Privilege Type	Object Types	Screen Criteria
Settlement Instruction Query	DDQ_SettlInstruct Query	Object	Securities Account, Party	n/a

6.4.4.87 Status History - Details Screen

△ [▶ 267]

No privileges.

6.4.4.88 T2S DCA Balance - Details Screen

△ [▶ 362]

No privileges.

6.4.4.89 T2S DCA Balances - Search/List Screen

△ [▶ 358]

Privilege	Privilege Code	Privilege Type	Object Types	Screen Criteria
T2S Dedicated Cash Account Balance Query	DDQ_T2SDedicated CashAcc Balance Query	Object	T2S Dedicated Cash Account	n/a

6.4.4.90 T2S DCA Postings - Search/List Screen

△ [▶ 364]

Privilege	Privilege Code	Privilege Type	Object Types	Screen Criteria
T2S Dedicated Cash Account Posting Query	DDQ_T2S Dedicated	Object	T2S Dedicated Cash Account	n/a

Total Amount of Standing/Predefined Liquidity Transfer Orders - Search/List Screen

Privilege	Privilege Code	Privilege Type	Object Types	Screen Criteria
	CashAcc Posting Query			

6.4.4.91 Total Amount of Standing/Predefined Liquidity Transfer Orders - Search/List Screen

△ [▶ 401]

Privilege	Privilege Code	Privilege Type	Object Types	Screen Criteria
Total Amount of Standing and Predefined Orders Query	DCQ_TotAmountStand+PredefOrdQuery	Object	T2S Dedicated Account	n/a

6.4.4.92 Total Collateral Value per T2S Dedicated Cash Account - Search/List Screen

△ [▶ 370]

Privilege	Privilege Code	Privilege Type	Object Types	Screen Criteria
Total Collateral Value per T2S Dedicated Cash Account Query	DDQ_TotalCollatValuePerT2SDCAQuery	System	n/a	n/a

6.4.5 Privilege Classes for LTSI Screens

Class of Privileges	Privilege Name	Privilege Short Name
Other	Long Term Statistical Information – Advanced User	ARM_GrantPrivilege
Other	Long Term Statistical Information Access	LTSI Access

6.4.6 Privileges for LTSI Screens

LTSI user profiles are created based on the Static data Privileges and also on the Party identifiers, stored in Static Data Users, and their party types associated.

LTSI can also provide access to internal users, not sent by Static Data.

Possible LTSI privileges can be:

- NCB end user: Static Data Party type= NCB, Static Data privilege= GFS user profile: Basic Statistical User
- CSD end user: Static Data Party type= CSD, Static Data privilege= GFS user profile: Basic Statistical User
- CSD participant end user: Static Data Party type= CSD, Static Data privilege= GFS user profile: Basic Statistical User
- External CSD end user: Static Data Party type= External CSD, Static Data privilege= GFS user profile: Basic Statistical User
- NCB analyst: Static Data Party type=NCB, Static Data privilege= and eventually also, GFS user profile: Basic Statistical User and Advanced Statistical User
- CSD analyst: Static Data Party type=CSD, Static Data privilege= and eventually also , GFS user profile: Basic Statistical User and Advanced Statistical User
- LTSI super user: Not sent by Static Data, Internal user, GFS user profile: Basic Statistical User and Advanced Statistical User
- Administrator: Not sent by Static Data, Internal user, GFS user profile: Statistical Workspace administrator

The party type has an impact on the final LTSI privilege: for instance, a CSD Participant or external CSD can only be an end user, but not an analyst, and can have access only to business reports, but not to technical reports. Only NCB analysts and NCB end users can have access to reports on Liquidity Transfers, but not CSDs or CSD Participants or External CSD.

Each predefined report and query can be accessible only to a specific restricted list of LTSI privileges.

6.4.6.1 BSIQ.01 - Multi-criteria search of a set of Settlement Instructions - List Screen

△

Privileges
NCB analyst
NCB end user

Privileges
CSD analyst
CSD end user
CSD participant end user
External CSD end user

6.4.6.2 BSIQ.00 - Individual Settlement detailed Query – List Screen

△

Privileges
NCB analyst
CSD analyst
NCB end user
CSD end user
CSD participant end user
External CSD end user

6.4.6.3 BSIQ.00 - Individual Settlement detailed Query – Search Screen

△

Privileges
NCB analyst
CSD analyst
NCB end user
CSD end user
CSD participant end user
External CSD end user

6.4.6.4 BSIQ.01 - Multi-criteria search of a set of Settlement Instructions - Search Screen

△

Privileges
NCB analyst

Privileges
NCB end user
CSD analyst
CSD end user
CSD participant end user
External CSD end user

6.4.6.5 BSIQ.02 - Individual Restriction detailed Query – List Screen

△

Privileges
NCB analyst
CSD analyst
NCB end user
CSD end user
CSD participant end user
External CSD end user

6.4.6.6 BSIQ.02 - Individual Restriction detailed Query – Search Screen

△

Privileges
NCB analyst
CSD analyst
NCB end user
CSD end user
CSD participant end user
External CSD end user

6.4.6.7 BSIQ.03 - Multi-criteria search of a set of Settlement Restrictions - List Screen

△

Privileges
NCB analyst
NCB end user
CSD analyst
CSD end user
CSD participant end user
External CSD end user

6.4.6.8 BSIQ.03 - Multi-criteria search of a set of Settlement Restrictions - Search Screen

△

Privileges
NCB analyst
NCB end user
CSD analyst
CSD end user
CSD participant end user
External CSD end user

6.4.6.9 BSIQ.04 - Multi-criteria search of a set of Liquidity Transfers - List Screen

△

Privileges
NCB analyst
NCB end user

6.4.6.10 BSIQ.04 - Multi-criteria search of a set of Liquidity Transfers - Search Screen

△

Privileges
NCB analyst
NCB end user

6.4.6.11 BSIQ.05 - Multi-criteria search of a set of Business Cancellations - List Screen



Privileges
NCB analyst
NCB end user
CSD analyst
CSD end user
CSD participant end user
External CSD end user

6.4.6.12 BSIQ.05 - Multi-criteria search of a set of Business Cancellations - Search Screen



Privileges
NCB analyst
NCB end user
CSD analyst
CSD end user
CSD participant end user
External CSD end user

6.4.6.13 BSIQ.06 - Multi-criteria search of a set of Amendment Instructions – List Screen



Privileges
NCB analyst
NCB end user
CSD analyst
CSD end user
CSD participant end user
External CSD end user

6.4.6.14 BSIQ.06 - Multi-criteria search of a set of Amendment Instructions - Search Screen



Privileges
NCB analyst
NCB end user
CSD analyst
CSD end user
CSD participant end user
External CSD end user

6.4.6.15 BSIQ.07 - Multi-criteria search of a set of Hold and Release Instructions - List Screen



Privileges
NCB analyst
NCB end user
CSD analyst
CSD end user
CSD participant end user
External CSD end user

6.4.6.16 BSIQ.07 - Multi-criteria search of a set of Hold and Release Instructions - Search Screen



Privileges
NCB analyst
NCB end user
CSD analyst
CSD end user
CSD participant end user
External CSD end user

6.4.6.17 BSIR.00 - T2SDCA: Finalised matched Instructions – List Screen



Privileges
NCB analyst
NCB end user

6.4.6.18 BSIR.00 - T2SDCA: Finalised matched Instructions – Search Screen



Privileges
NCB analyst
NCB end user

6.4.6.19 BSIR.01 - Securities Account: Finalised matched Instructions - List Screen



Privileges
CSD analyst
CSD end user
CSD participant end user
External CSD end user

6.4.6.20 BSIR.01 - Securities Account: Finalised matched Instructions - Search Screen



Privileges
CSD analyst
CSD end user
CSD participant end user
External CSD end user

6.4.6.21 BSIR.02 - T2SDCA: Detailed Finalised matched Settlement Instructions - List Screen



Privileges
NCB analyst
NCB end user

6.4.6.22 BSIR.02 - T2SDCA: Detailed Finalised matched Settlement Instructions - Search Screen



Privileges
NCB analyst
NCB end user

6.4.6.23 BSIR.03 - Securities Account: Detailed Finalised matched Settlement Instructions - List Screen



Privileges
NCB analyst
NCB end user
CSD analyst
CSD end user
CSD participant end user
External CSD end user

6.4.6.24 BSIR.03 - Securities Account: Detailed Finalised matched Settlement Instructions - Search Screen



Privileges
NCB analyst
CSD analyst
NCB end user

Privileges
CSD end user
CSD participant end user
External CSD end user

6.4.6.25 BSIR.04 - T2SDCA: Follow-up by time slot of Settlement Activity - List Screen

△

Privileges
NCB analyst
NCB end user

6.4.6.26 BSIR.04 - T2SDCA: Follow-up by time slot of Settlement Activity - Search Screen

△

Privileges
NCB analyst
NCB end user

6.4.6.27 BSIR.05 - T2SDCA: Comparison of Settlement activity between two time periods - List Screen

△

Privileges
NCB analyst
NCB end user

6.4.6.28 BSIR.05 - T2SDCA: Comparison of Settlement activity between two time periods - Search Screen

△

Privileges
NCB analyst
NCB end user

6.4.6.29 CMBR.00 - Journaling of Limit Utilisations of Primary CMB - Search Screen

△

Privileges
NCB analyst

6.4.6.30 CMBR.00 - Journaling of Limits Utilisations of Primary CMB - List Screen

△

Privileges
NCB analyst

6.4.6.31 CMBR.01 - Journaling of Limits Utilisations of Secondary CMB - List Screen

△

Privileges
NCB analyst

6.4.6.32 CMBR.01 - Journaling of Limits Utilisations of Secondary CMB - Search Screen

△

Privileges
NCB analyst

6.4.6.33 COLL.00 - T2SDCA: Follow-up by time slot of Settled Collateralisation Instructions - List Screen

△

Privileges
NCB analyst

6.4.6.34 COLL.00 - T2SDCA: Follow-up by time slot of Settled Collateralisation Instructions - Search Screen

△

Privileges

NCB analyst

6.4.6.35 COLL.01 - Securities Accounts: Follow up by time slot of Settled Collateralisation Instructions - Search Screen

△

Privileges

CSD analyst

6.4.6.36 COLL.01 - Securities Accounts: Follow-up by time slot of Settled Collateralisation Instructions - List Screen

△

Privileges

CSD analyst

6.4.6.37 COLL.02 - T2SDCA: Settled or Cancelled (automatic or manual) Collateralisation Instructions - List Screen

△

Privileges

NCB analyst

6.4.6.38 COLL.02 - T2SDCA: Settled or Cancelled (automatic or manual) Collateralisation Instructions - Search Screen

△

Privileges

NCB analyst

6.4.6.39 CPST.00 - T2SDCA: Follow-up by time slot of Cash Postings - List Screen

△

Privileges
NCB analyst
NCB end user

6.4.6.40 CPST.00 - T2SDCA: Follow-up by time slot of Cash Postings - Search Screen

△

Privileges
NCB analyst
NCB end user

6.4.6.41 LIQU.00 - Liquidity Transfers - List Screen

△

Privileges
NCB analyst
NCB end user

6.4.6.42 LIQU.00 - Liquidity Transfers - Search Screen

△

Privileges
NCB analyst
NCB end user

6.4.6.43 REAL.00 - Detailed Realignment and Other Technical Instructions - List Screen

△

Privileges
CSD analyst

6.4.6.44 REAL.00 - Detailed Realignment and Other Technical Instructions - Search Screen

△

Privileges
CSD analyst

6.4.6.45 REST.00 - Detailed Cash Restrictions - List Screen



Privileges
NCB analyst
NCB end user

6.4.6.46 REST.00 - Detailed Cash Restrictions - Search Screen



Privileges
NCB analyst
NCB end user

6.4.6.47 REST.01 - Detailed Securities Restrictions - Search Screen



Privileges
CSD analyst
CSD end user
CSD Participant end user
External CSD end user

6.4.6.48 REST.01 - Detailed Securities Restrictions - List Screen



Privileges
CSD analyst
CSD end user
CSD Participant end user

Privileges
External CSD end user

6.4.6.49 SPST.00 - Securities Account: Follow-up by time schedule of Securities Postings - List Screen

△

Privileges
NCB analyst
NCB end user
CSD analyst
CSD end user
CSD participant end user
External CSD end user

6.4.6.50 SPST.00 - Securities Account: Follow-up by time schedule of Securities Postings - Search Screen

△

Privileges
NCB analyst
NCB end user
CSD analyst
CSD end user
CSD participant end user
External CSD end user

6.4.6.51 XREP.00 - T2SDCA: Matched Cancelled Instructions - List Screen

△

Privileges
NCB analyst
NCB end user

6.4.6.52 XREP.00 - T2SDCA: Matched Cancelled Instructions - Search Screen



Privileges
NCB analyst
NCB end user

6.4.6.53 XREP.01 - Securities Account: Matched Cancelled Instructions - List Screen



Privileges
NCB analyst
CSD analyst
NCB end user
CSD end user
CSD participant end user
External CSD end user

6.4.6.54 XREP.01 - Securities Account: Matched Cancelled Instructions - Search Screen



Privileges
CSD analyst
CSD end user
CSD Participant end user
External CSD end user

6.4.6.55 XREP.02 - Finalised Non Matched Cancellations - List Screen



Privileges
CSD analyst
CSD end user

Privileges
CSD Participant end user
External CSD end user

6.4.6.56 XREP.02 - Finalised Non Matched Cancellations - Search Screen

△

Privileges
CSD analyst
CSD end user
CSD participant end user
External CSD end user

6.4.7 Privileges for DWH Screens

Privilege Name	Privilege Short Name	Authorised to
Normal user	NORU	<ul style="list-style-type: none"> <input type="checkbox"/> Access to predefined DWH reports <input type="checkbox"/> Use available parameters and filter criteria on predefined DWH reports <input type="checkbox"/> Execute predefined DWH reports <input type="checkbox"/> Execute user-defined reports (only CB users) <input type="checkbox"/> Download DWH report results
Advanced user	ADVU	<ul style="list-style-type: none"> <input type="checkbox"/> Same as normal user <input type="checkbox"/> Create user defined DWH Reports <input type="checkbox"/> Configure the scheduling of DWH reports

Privilege Name	Privilege Short Name	Authorised to
		<ul style="list-style-type: none"> <input type="checkbox"/> Store adaptable/user defined DWH reports in an individual dedicated folder <input type="checkbox"/> Share (user defined) DWH reports with all other users within their CB or with other CBs in a dedicated folder

6.5 List of References for Error Messages

6.5.1 Reader's Guide

Reader's Guide

This section includes a list of references for error messages for all screens, structured along GUI screens, TMS screens. For GUI screens, the list of references for error messages consists of a general section, which lists overall error codes that apply to all GUI screens, and a section listing all error codes relevant for using the 4-eyes mode in GUI screens. For all sections, these are followed by specific sections for individual screens, which are organised in alphabetical screen order and specify the respective error codes applicable for each screen. Each error code table entry includes the error text and the description.

6.5.2 References for Error Messages for T2S GUI Screens

6.5.2.1 All

Reference for error message	Field or Button	Error Text	Description
DXAA007		Only one instance may become effective in the future	Each historical entity may have no more than one future instance.

Reference for error message	Field or Button	Error Text	Description
ICAC001		Online access to the T2S system is not available	Users accessing T2S in U2A mode must be alerted when U2A access to T2S is unavailable.
ICUR002		Required Certificate Authentication failed.	Authentication in U2A mode is possible by using simple authentication, advanced certificate authentication or smartcard authentication. Strong authentication mechanisms are ensured via two-factor authentication.
ICUR003		Your password has expired. Please change.	The password has to be changed as defined in the security requirements.
ICUR004		Request is only allowed during valid session. Please log in.	Requests except login request are only possible, if the user is logged in with a valid session.
ICUR005		The T2S system user is blocked due to lockout	The T2S system user should be able to login. Therefore the lockout status has to be 'False'.
ICUR007		The Party Technical Address is not known for the used Network Service.	The technical sending user (Party Technical Address) has to be known for the used network service.
ICUR008			Authentication remains active for the entire session.

Reference for error message	Field or Button	Error Text	Description
ICUR009		Password is invalid for T2S.	The correct password has to be entered while starting a new session.
ICUR010		The Technical Sending User is not known for T2S.	The Technical Sending User (Party Technical Address) which was used for sending the inbound U2A communication has to be known in T2S.
ICUR011		The Business Sending User is not known in T2S.	The Business Sending User has to be known in T2S.
ICUR012		The T2S System User sending the inbound U2A communication is not known in T2S.	The T2S System User sending the inbound U2A communication has to be known in T2S.
ICUR013		The Party Technical Address is not known for the Business Sending Party.	Technical Sending User is allowed to send for the Business Sending Party.
ICUR014		Business Sending User is not allowed to send for the T2S Internal System User.	Business sending user is allowed to send for the T2S internal system user.
IICF001		Your request is rejected because it is not allowed during this business day phase. Please try again later.	The availability of some U2A requests is restricted on the basis of phases of the business day. The request can only be forwarded, if the functionality is currently available (not restricted).

Reference for error message	Field or Button	Error Text	Description
IICP001		The system user is not authorised to initiate such request due to missing privilege.	A system user must have the appropriate privilege to be authorised for an intended request. The check only includes generic authorisation for the requested action at system level. The check for the data scope including object level is processed in the backend modules.
IIUR001		The request could not be processed due to a failed validation of syntax and structure <!--Dynamic error message(s) is/are mentioned including the respective screen attribute-->	A request is compliant to the syntax and structure of requests required by T2S in the U2A mode.

6.5.2.2 All Screens which allow the initiation of a query

Reference for error message	Field or Button	Error Text	Description
QMPQ001		The System User has not the privilege to initiate such a request for the specified object.	A system user must have the appropriate privilege for the specified object to be permitted to query the requested information.

Reference for error message	Field or Button	Error Text	Description
QMPQ002		The System User has not the privilege to initiate such a request.	A system user must have the appropriate privilege for at least one object to be permitted to query the requested information.

6.5.2.3 All Screens which allow the initiation of a second user action (4-eyes mode)

Reference for error message	Field or Button	Error Text	Description
DXAA002		Data awaiting for approval cannot be modified	It is not allowed to perform a maintenance request, neither in 2-eyes nor in 4-eyes first step mode, that refers to an instance already awaiting for approval.
DXAA011		Invalid approval requestor (must be different from the first requestor)	In case of approval request (4-eyes second step), the requestor must be different from the requestor of the first step. It can be equal only in case of revocation (confirmation = 'NO')
DXAA035		Request to be approved not found	In case of approval request (4-eyes second step), the request must refer to an existing instruction and the related entity(ies) must be in status 'Awaiting approval'.

Reference for error message	Field or Button	Error Text	Description
IICP003		The T2S System User is not authorised to confirm the own initial request.	The T2S System User has to be different for the initial request (4-eyes first step) and the confirmation (4-eyes second step) initiated via approval request. In case of revocation the T2S System User can be the same.
IICP004		The initial request is already completed with status approved, queued, rejected or revoked.	A successful approval request (second user action; confirmation or revocation) is only possible, if the status of the 4-eyes principle entry is different from 'Approved', 'Queued', 'Rejected' or 'Revoked'.
IICP005		An approval request (second user action; confirmation or revocation) is already in processing.	A successful approval request (second user action; confirmation or revocation) is only possible, if there is no approval request in processing.
IICP006		The T2S System Users for the initial request and the confirmation have to be linked to the same party.	The T2S System Users for the initial request (4-eyes first step) and the confirmation (4-eyes second step) initiated via approval request have to be linked to the same party.

6.5.2.4 Allegement Instruction - Details Screen

△ [▶ 94]

No references for error messages.

6.5.2.5 Allegement Instructions - Search/List Screen

△ [▶ 90]

Reference for error message	Field or Button	Error Text	Description
QMPC015	<input type="checkbox"/> Creation Date and Time from field <input type="checkbox"/> Creation Date and Time to field <input type="checkbox"/> Search button	The Date From is after the Date To.	In case the Date is stated as a range, the Date From has to be before or equal to the Date To.

6.5.2.6 Amendment Cash Instruction - Details Screen

△ [▶ 405]

No references for error messages.

6.5.2.7 Amendment Cash Instruction - New Screen

△ [▶ 410]

Reference for error message	Field or Button	Error Text	Description
MMIA002	<input type="checkbox"/> Submit button	Settlement Restriction referenced by an Amendment Instruction is already settled.	The Settlement Status of a Settlement Restriction referenced by an Amendment Instruction must not be 'Settled'.
MMIA004	<input type="checkbox"/> Submit button	Settlement Restriction referenced by an Amendment Instruction is already partially settled.	The Settlement Status of a Settlement Restriction referenced by an Amendment Instruction must not be 'Partially Settled' if the modification is not referred to Priority.

Reference for error message	Field or Button	Error Text	Description
MMIA006	<input type="checkbox"/> Submit button	Settlement Restriction referenced by an Amendment Instruction is already cancelled.	The Cancellation Status of a Settlement Restriction referenced by an Amendment Instruction must not be 'Cancelled'.
MVCM956	<input type="checkbox"/> Submit Button	The Condition Modification Instruction referring to a Settlement Restriction contains a pool reference or more than one link referring to the same instruction.	A Condition Modification Instruction that tries to amend a Settlement Restriction must not contain a pool reference or more than one link referring to the same instruction.
MVCM958	<input type="checkbox"/> Actor Reference field <input type="checkbox"/> Link/Unlink field <input type="checkbox"/> T2S Reference field <input type="checkbox"/> Submit button	The linkage specified in the Condition Modification Instruction does not exist for the referenced Settlement Restriction or it is pending to be executed in the system.	When a Condition Modification Instruction tries to amend the linkages of a Settlement Restriction with an unlink type, the corresponding link must exist for the referenced Settlement Restriction and it must not be already pending to be executed in the system.
MVCM960	<input type="checkbox"/> Link/Unlink field <input type="checkbox"/> Reference field <input type="checkbox"/> Submit button	The linkage specified in the Condition Modification Instruction does not exist for the referenced Settlement Restriction or the amendment is already pending to be executed in the system.	When a Condition Modification Instruction tries to amend the linkages of a Settlement Restriction with a LINK linkage type, the corresponding link regardless its processing position, must not exist for the referenced Settlement Restriction and it must

Reference for error message	Field or Button	Error Text	Description
			not be already pending to be executed in the system. Only creation of new links are possible.
MVCP004	<ul style="list-style-type: none"> <input type="checkbox"/> Actor Reference field <input type="checkbox"/> T2S Reference field <input type="checkbox"/> Submit Button 	The underlying instruction referenced by a Condition Modification Instruction does not exist in T2S.	The underlying instruction of a Condition Modification instruction must exist in T2S.
MVCP034	<ul style="list-style-type: none"> <input type="checkbox"/> Amendment Type field 	The sender of an Amendment Instruction is not authorised to amend Process Indicators of a Settlement Restriction on Cash on the T2S Dedicated Cash Account.	The sender of an Amendment Instruction that intends to amend Process Indicators of a Settlement Restriction on Cash must be authorised to amend Process Indicators of a Settlement Restriction on Cash on a specific T2S Dedicated Cash Account.
MVCP042	<ul style="list-style-type: none"> <input type="checkbox"/> Link Type field <input type="checkbox"/> Submit button 	The sender of a Condition Modification Instruction is not authorised to link a Settlement Restriction on Cash to an instruction/pool belonging to another party.	The sender of a Condition Modification Instruction that intends to link a Settlement Restriction on Cash to another instruction or pool must be authorised to link to an instruction/pool belonging to a specific party.
MVCP099	<ul style="list-style-type: none"> <input type="checkbox"/> Reference Type field <input type="checkbox"/> Reference field <input type="checkbox"/> Submit button 	The Reference Owner of the Linked Instruction does not belong to	If a T2S actor wants to make use of linkages across several instructions sent to T2S via

Reference for error message	Field or Button	Error Text	Description
		the CSD (parent CSD in case of an external CSD) or NCB of the Instructing Party.	different CSDs or NCBs he holds accounts with, the T2S actor has to make use of the T2S reference.
MVCP122	<ul style="list-style-type: none"> <input type="checkbox"/> Instructing Party BIC field <input type="checkbox"/> Instructing Party Parent BIC field <input type="checkbox"/> Submit button 	The sender of an Amendment Instruction is not authorised to send an Amendment Instruction using this Instructing Party.	If the sender of an Amendment Instruction does not belong to the Instructing Party, then the sender of an Amendment Instruction must be authorised to send an Amendment Instruction using the Instructing Party.
MVCV107	<ul style="list-style-type: none"> <input type="checkbox"/> Instructing Party BIC field <input type="checkbox"/> Instructing Party Parent BIC field <input type="checkbox"/> Submit button 	The Instructing Party specified in the Amendment Instruction is not open on the current business date.	The Instructing Party specified in an Amendment Instruction must be open on the current business date.
MVCV232	<ul style="list-style-type: none"> <input type="checkbox"/> Instructing Party BIC field <input type="checkbox"/> Instructing Party Parent BIC field <input type="checkbox"/> Submit button 	The Instructing Party BIC or Parent BIC specified in the Amendment Instruction is not valid on the current business date.	The Instructing Party BIC and Parent BIC indicated in an Amendment Instruction must be valid on the current business date.
MVDC026	<ul style="list-style-type: none"> <input type="checkbox"/> Instructing Party BIC field <input type="checkbox"/> Instructing Party Parent BIC field <input type="checkbox"/> Submit button 	The Instructing Party specified in the Condition Modification Instruction does not exist in T2S Static Data.	The Instructing Party specified in a Condition Modification Instruction must exist in T2S Static Data.

Reference for error message	Field or Button	Error Text	Description
MVLI809	<input type="checkbox"/> Link Type field <input type="checkbox"/> Submit button	The instruction has a Settlement link indicator 'WITH' and the existing Linked Instruction is already settled.	If an Amendment Instruction tries to add a link 'WITH' to a Settlement Instruction or Settlement Restriction the linked Settlement Instruction or Settlement Restriction must not be 'Settled'.
MVLI810	<input type="checkbox"/> Link Type field <input type="checkbox"/> Submit button	The instruction has a Settlement link indicator 'WITH' and the existing Linked Instruction is already cancelled.	If an Amendment Instruction tries to add a link 'WITH' to a Settlement Instruction or Settlement Restriction the linked Settlement Instruction or Settlement Restriction must not be 'Cancelled'.
MVLI811	<input type="checkbox"/> Link Type field <input type="checkbox"/> Submit button	The instruction has a Settlement link indicator 'BEFORE' and the existing linked Settlement instruction is already settled.	If an Amendment Instruction tries to add a link 'BEFORE' to a Settlement Instruction or Settlement Restriction the linked Settlement Instruction or Settlement Restriction must not be 'Settled'.
MVLI825	<input type="checkbox"/> Link Type field <input type="checkbox"/> Submit button	The instruction has a Settlement link indicator 'BEFORE' and the Settlement link indicator included in the existing linked instruction is 'WITH'.	If an Amendment Instruction intends to add a new link 'BEFORE' to a Settlement Instruction or Settlement Restriction, these latter must not have a previous link 'WITH' with the Settlement Instruction stated in the amendment (as linked instruction) un-

Reference for error message	Field or Button	Error Text	Description
			less they have the same Intended Settlement Date.
MVLI826	<input type="checkbox"/> Link Type field <input type="checkbox"/> Submit button	The instruction has a Settlement link indicator 'AFTER' and the Settlement link indicator included in the existing linked instruction is 'WITH'.	If an Amendment Instruction intends to add a new link 'AFTER' to a Settlement Instruction or Settlement Restriction, these latter must not have a previous link 'WITH' with the Settlement Instruction stated in the amendment (as linked instruction) unless they have the same Intended Settlement Date.
MVLI827	<input type="checkbox"/> Link Type field <input type="checkbox"/> Submit button	The instruction has a Settlement link indicator 'AFTER' and the Settlement link indicator included in the existing linked instruction is 'AFTER'.	If an Amendment Instruction intends to add a new link 'AFTER' to a Settlement Instruction or Settlement Restriction, these latter must not have a previous link 'AFTER' with the Settlement Instruction stated in the amendment (as linked instruction) unless they have the same Intended Settlement Date.
MVLI828	<input type="checkbox"/> Link Type field <input type="checkbox"/> Submit button	The instruction has a Settlement link indicator 'WITH' and the Settlement link indicator in-	If an Amendment Instruction intends to add a new link 'WITH' to a Settlement Instruction or Settlement Restriction, these latter must not have a previous link

Reference for error message	Field or Button	Error Text	Description
		cluded in the existing linked instruction is 'AFTER'.	'AFTER' with the Settlement Instruction stated in the amendment (as linked instruction) unless they have the same Intended Settlement Date.
MVLI829	<input type="checkbox"/> Link Type field <input type="checkbox"/> Submit button	The instruction has a Settlement link indicator 'BEFORE' and the Settlement link indicator included in the existing linked instruction is 'BEFORE'.	If an Amendment Instruction intends to add a new link 'BEFORE' to a Settlement Instruction or Settlement Restriction, these latter must not have a previous link 'BEFORE' with the Settlement Instruction stated in the amendment (as linked instruction) unless they have the same Intended Settlement Date.
MVLI830	<input type="checkbox"/> Link Type field <input type="checkbox"/> Submit button	The instruction has a Settlement link indicator 'WITH' and the Settlement link indicator included in the existing linked instruction is 'BEFORE'.	If an Amendment Instruction intends to add a new link 'WITH' to a Settlement Instruction or Settlement Restriction, these latter must not have a previous link 'BEFORE' with the Settlement Instruction stated in the amendment (as linked instruction) unless they have the same Intended Settlement Date.
MVLI837	<input type="checkbox"/> Link Type field <input type="checkbox"/> Submit button	The instruction has a Settlement link indicator 'BE-	If an Amendment Instruction tries to add a link 'BEFORE' to a Set-

Reference for error message	Field or Button	Error Text	Description
		FORE' and the linked instruction's Intended Settlement Date is earlier than the validating instruction's Intended Settlement Date.	Amendment Instruction or Settlement Restriction, the Intended Settlement Date of the referenced Settlement Instruction or Settlement Restriction must be equal to or earlier than the Intended Settlement Date of the linked Settlement Instruction or Settlement Restriction, if this latter instruction is in T2S.
MVLI838	<input type="checkbox"/> Link Type field <input type="checkbox"/> Submit button	The instruction has a Settlement link indicator 'AFTER' and the linked instruction's Intended Settlement Date is later than the validating instruction's Intended Settlement Date.	If an Amendment Instruction tries to add a link 'AFTER' to a Settlement Instruction or Settlement Restriction, the Intended Settlement Date of the referenced Settlement Instruction or Settlement Restriction must be equal to or later than the Intended Settlement Date of the linked Settlement Instruction or Settlement Restriction, if this latter instruction is in T2S.
MVLI839	<input type="checkbox"/> Link Type field <input type="checkbox"/> Submit button	The instruction has a Settlement link indicator 'WITH' and the linked instruction's Intended Settlement Date is different.	If an Amendment Instruction tries to add a link 'WITH' to a Settlement Instruction or Settlement Restriction, the Intended Settlement Date of the referenced Settlement Instruction

Reference for error message	Field or Button	Error Text	Description
			or Settlement Restriction must be equal to the Intended Settlement Date of the linked Settlement Instruction or Settlement Restriction, if this latter instruction is in T2S.
MVLI852	<ul style="list-style-type: none"><input type="checkbox"/> Link Type field<input type="checkbox"/> Reference field<input type="checkbox"/> Submit button	The instruction has a Settlement link indicator 'WITH' and the existing Linked Instruction is already partially settled.	The Settlement Status of a Settlement Instruction or Settlement Restriction stated as linked instruction with Link Processing Position 'WITH' in a Settlement Restriction must not be 'Partially Settled'.
MVLI855	<ul style="list-style-type: none"><input type="checkbox"/> Link Type field<input type="checkbox"/> Reference field<input type="checkbox"/> Submit button	The instruction has a Settlement link indicator 'BEFORE' and the existing Linked Instruction is already partially settled.	The Settlement Status of a Settlement Instruction or Settlement Restriction stated as linked instruction with Link Processing Position 'BEFORE' in a Settlement Restriction must not be 'Partially Settled'.
MVLI858	<ul style="list-style-type: none"><input type="checkbox"/> Link Type field<input type="checkbox"/> Reference field<input type="checkbox"/> Submit button	The instruction has a Settlement link indicator 'AFTER' and the existing Linked Instruction is already partially settled.	The Settlement Status of a Settlement Instruction or Settlement Restriction stated as linked instruction with Link Processing Position 'AFTER' in a Settlement Restriction must not be 'Partially Settled'.

Reference for error message	Field or Button	Error Text	Description
MVLI861	<input type="checkbox"/> Link Type field <input type="checkbox"/> Reference field <input type="checkbox"/> Submit button	The instruction has a Settlement link indicator 'AFTER' and the existing Linked Instruction is already cancelled.	The Settlement Status of a Settlement Instruction or Settlement Restriction stated as linked instruction with Link Processing Position 'AFTER' in a Settlement Restriction must not be 'Cancelled'.
MVLI871	<input type="checkbox"/> Link/Unlink field <input type="checkbox"/> Reference field <input type="checkbox"/> Submit button	The linked instruction referenced by a T2S Instruction Reference in the Amendment Instruction, does not exist in T2S.	If an Amendment Instruction intends to modify an instruction link, and the instruction is referenced by the T2S Instruction Reference, then the instruction must exist in T2S.
MVLI874	<input type="checkbox"/> Link Type field <input type="checkbox"/> Reference field <input type="checkbox"/> Submit button	The Processing Position must be specified in the Amendment Instruction.	If an Amendment Instruction intends to modify an instruction link, and the instruction is referenced by the T2S Instruction Reference or the T2S Actor Instruction Reference, then the Processing Position must be filled in.
MVSP211	<input type="checkbox"/> Priority field <input type="checkbox"/> Submit button	'Reserved priority' not allowed for the Instructing Party Type (only NCBs can use it)	'Reserved priority' is allowed in an Amendment Instruction on Settlement Restriction on Cash only if the Instructing Party of the referenced instruction is a NCB.

6.5.2.8 Amendment Securities Instruction - Details Screen

△ [▶ 98]

No references for error messages.

6.5.2.9 Amendment Securities Instruction - New Screen

△ [▶ 103]

Reference for error message	Field or Button	Error Text	Description
MMIA001	<input type="checkbox"/> Submit button	Settlement Instruction referenced by an Amendment Instruction is already settled.	The Settlement Status of a Settlement Instruction referenced by an Amendment Instruction must not be 'Settled'.
MMIA002	<input type="checkbox"/> Submit button	Settlement Restriction referenced by an Amendment Instruction is already settled.	The Settlement Status of a Settlement Restriction referenced by an Amendment Instruction must not be 'Settled'.
MMIA003	<input type="checkbox"/> Amendment Type field <input type="checkbox"/> Submit button	Settlement Instruction referenced by an Amendment Instruction is already partially settled.	The Settlement Status of a Settlement Instruction referenced by an Amendment Instruction must not be 'Partially Settled' if the modification is not referred to Priority.
MMIA004	<input type="checkbox"/> Amendment Type field <input type="checkbox"/> Submit button	Settlement Restriction referenced by an Amendment Instruction is already partially settled.	The Settlement Status of a Settlement Restriction referenced by an Amendment Instruction must not be 'Partially Settled' if the modification is not referred to Priority.

Reference for error message	Field or Button	Error Text	Description
MMIA005	<input type="checkbox"/> Submit button	Settlement Instruction referenced by an Amendment Instruction is already cancelled.	The Cancellation Status of a Settlement Instruction referenced by an Amendment Instruction must not be 'Cancelled'.
MMIA006	<input type="checkbox"/> Submit button	Settlement Restriction referenced by an Amendment Instruction is already cancelled.	The Cancellation Status of a Settlement Restriction referenced by an Amendment Instruction must not be 'Cancelled'.
MMIA009	<input type="checkbox"/> Submit button	Settlement Instruction referenced by an Amendment Instruction is in a CoSD Group.	The CoSD Flag of a Settlement Instruction referenced by an Amendment Instruction must not be 'Yes', except when the Instructing Party is a CSD and the Amendment Instruction aims to remove the linkage from a settlement instruction.
MVCM952	<input type="checkbox"/> Amendment Type field <input type="checkbox"/> Submit button	The Condition Modification Instruction does not refer to the modifiable process indicators of a Settlement Restriction.	A Condition Modification Instruction that tries to amend a Settlement Restriction on Securities must modify only the settlement priority or the linkages
MVCM955	<input type="checkbox"/> Submit button	The Condition Modification Instruction referring to a Settlement Instruction contains a pool reference or more than one link referring to the same instruction.	A Condition Modification Instruction that tries to amend a Settlement Instruction must not contain a pool reference or more than one link referring to the same instruction.

Reference for error message	Field or Button	Error Text	Description
MVCM956	<input type="checkbox"/> Submit button	The Condition Modification Instruction referring to a Settlement Restriction contains a pool reference or more than one link referring to the same instruction.	A Condition Modification Instruction that tries to amend a Settlement Restriction must not contain a pool reference or more than one link referring to the same instruction.
MVCM957	<input type="checkbox"/> Actor Reference field <input type="checkbox"/> T2S Reference field <input type="checkbox"/> Link/Unlink field <input type="checkbox"/> Submit button	The linkage specified in the Condition Modification Instruction does not exist for the referenced Settlement Instruction or it is pending to be executed in the system.	When a Condition Modification Instruction tries to amend the linkages of a Settlement Instruction with an unlink type, the corresponding link must exist for the referenced Settlement Instruction and it must not be already pending to be executed in the system.
MVCM958	<input type="checkbox"/> Actor Reference field <input type="checkbox"/> T2S Reference field <input type="checkbox"/> Link/Unlink field <input type="checkbox"/> Submit button	The linkage specified in the Condition Modification Instruction does not exist for the referenced Settlement Restriction or it is pending to be executed in the system.	When a Condition Modification Instruction tries to amend the linkages of a Settlement Restriction with an unlink type, the corresponding link must exist for the referenced Settlement Restriction and it must not be already pending to be executed in the system.
MVCM959	<input type="checkbox"/> Actor Reference field	The linkage specified in the Condition Modification Instruction exists	When a Condition Modification Instruction tries to amend the linkages of a Settlement In-

Reference for error message	Field or Button	Error Text	Description
	<ul style="list-style-type: none"> <input type="checkbox"/> T2S Reference field <input type="checkbox"/> Link/Unlink field <input type="checkbox"/> Submit button 	for the referenced Settlement Instruction or the amendment is already pending to be executed in the system.	struction with a LINK linkage type, the corresponding link regardless its processing position, must not exist for the referenced Settlement Instruction and it must not be already pending to be executed in the system. Only creation of new links are possible.
MVCM960	<ul style="list-style-type: none"> <input type="checkbox"/> Actor Reference field <input type="checkbox"/> T2S Reference field <input type="checkbox"/> Link/Unlink field <input type="checkbox"/> Submit button 	The linkage specified in the Condition Modification Instruction exists for the referenced Settlement Restriction or the amendment is already pending to be executed in the system.	When a Condition Modification Instruction tries to amend the linkages of a Settlement Restriction with a LINK linkage type, the corresponding link regardless its processing position, must not exist for the referenced Settlement Restriction and it must not be already pending to be executed in the system. Only creation of new links are possible.
MVCP004	<ul style="list-style-type: none"> <input type="checkbox"/> Actor Reference field <input type="checkbox"/> T2S Reference field <input type="checkbox"/> Submit button 	The underlying instruction referenced by a Condition Modification Instruction does not exist in T2S.	The underlying instruction of a Condition Modification instruction must exist in T2S.
MVCP027	<ul style="list-style-type: none"> <input type="checkbox"/> Securities Account Number field <input type="checkbox"/> Submit button 	The sender of the Amendment Instruction is not authorised to amend	The sender of an Amendment Instruction that intends to amend Process Indicators of a

Reference for error message	Field or Button	Error Text	Description
		Process Indicators of a Settlement Instruction on the Securities Account.	Settlement Instruction must be authorised to amend Process Indicators of a Settlement Instruction on a specific Securities Account.
MVCP028	<input type="checkbox"/> Submit button	The sender of the Amendment Instruction is not authorised to amend Process Indicators of a Settlement Instruction on behalf of an external CSD.	If the relevant Depository is an external CSD, the sender of an Amendment Instruction that intends to amend Process Indicators of a Settlement Instruction must be authorised to amend Process Indicators of a Settlement Instruction on behalf of that external CSD.
MVCP032	<input type="checkbox"/> Securities Account Number field <input type="checkbox"/> Submit button	The sender of the Amendment Instruction is not authorised to amend Process Indicators of a Settlement Restriction on Securities on the Securities Account.	The sender of an Amendment Instruction that intends to amend Process Indicators of a Settlement Restriction on Securities must be authorised to amend Process Indicators of a Settlement Restriction on Securities on a specific Securities Account.
MVCP039	<input type="checkbox"/> Submit button	The sender of a Condition Modification Instruction is not authorised to amend non-modifiable Instructions on behalf of the In-	The sender of a Condition Modification Instruction that intends to amend a Settlement Instruction identified as a non-modifiable instruction must be authorised to amend non-modifiable Instructions on be-

Reference for error message	Field or Button	Error Text	Description
		structing party of the Underlying Settlement Instruction.	half of the Instructing party of the Underlying Settlement Instruction.
MVCP040	<input type="checkbox"/> Link Type field <input type="checkbox"/> Submit button	The sender of a Condition Modification Instruction is not authorised to link a Settlement Instruction to an instruction/pool belonging to another party.	The sender of a Condition Modification Instruction that intends to link a Settlement Instruction to another instruction or pool must be authorised to link to an instruction/pool belonging to a specific party.
MVCP041	<input type="checkbox"/> Link Type field <input type="checkbox"/> Submit button	The sender of a Condition Modification Instruction is not authorised to link a Settlement Restriction on Securities to an instruction/pool belonging to another party.	The sender of a Condition Modification Instruction that intends to link a Settlement Restriction on Securities to another instruction or pool must be authorised to link to an instruction/pool belonging to a specific party.
MVCP044	<input type="checkbox"/> Securities Account Number field <input type="checkbox"/> Submit button	The Securities Account informed in the instruction does not exist in T2S.	The Securities Account informed in the instruction must exist in T2S.
MVCP095	<input type="checkbox"/> Submit button	The sender of an Amendment Instruction is not authorised to amend Process Indicators of a Settlement Instruction on behalf	If the relevant Depository is an external CSD, the sender of an Amendment Instruction that intends to amend Process Indicators of a Settlement Instruction must be authorised to amend Process Indicat-

Reference for error message	Field or Button	Error Text	Description
		of the parent CSD of the external CSD.	ors of a Settlement Instruction on behalf of the parent CSD of the external CSD.
MVCP099	<input type="checkbox"/> Reference Type field <input type="checkbox"/> Reference field <input type="checkbox"/> Submit button	The Reference Owner of the Linked Instruction does not belong to the CSD (parent CSD in case of an external CSD) or NCB of the Instructing Party.	If a T2S actor wants to make use of linkages across several instructions sent to T2S via different CSDs or NCBs he holds accounts with, the T2S actor has to make use of the T2S reference.
MVCP108	<input type="checkbox"/> Amendment Counterpart Instruction field <input type="checkbox"/> Submit button	The sender of an Amendment Instruction is not authorised to amend a Settlement Instruction on behalf of the external CSD of the counterparty or the parent CSD of that external CSD.	If the Depository of the counterpart is an external CSD, the sender of an Amendment Instruction that intends to amend both legs of an already matched Settlement Instruction must be authorised to amend a Settlement Instruction on behalf of that external CSD or the parent CSD of of that external CSD.
MVCP109	<input type="checkbox"/> Amendment Counterpart Instruction field <input type="checkbox"/> Submit button	The sender of an Amendment Instruction is not authorised to amend a Settlement Instruction on the Securities Account of the counterparty.	The sender of an Amendment Instruction that intends to amend both legs of an already matched Settlement Instruction must be authorised to amend a Settlement Instruction on the Securities Account of the counterparty (in case the

Reference for error message	Field or Button	Error Text	Description
			Amendment Instruction only informs one Securities Account, the other would be derived from the underlying Settlement Instruction).
MVCP122	<input type="checkbox"/> Instructing Party Parent BIC field <input type="checkbox"/> Instructing Party BIC field <input type="checkbox"/> Submit button	The sender of an Amendment Instruction is not authorised to send an Amendment Instruction using this Instructing Party.	If the sender of an Amendment Instruction does not belong to the Instructing Party, then the sender of an Amendment Instruction must be authorised to send an Amendment Instruction using the Instructing Party.
MVCV107	<input type="checkbox"/> Instructing Party Parent BIC field <input type="checkbox"/> Instructing Party BIC field <input type="checkbox"/> Submit button	The Instructing Party specified in the Amendment Instruction is not open on the current business date.	The Instructing Party specified in an Amendment Instruction must be open on the current business date.
MVCV232	<input type="checkbox"/> Instructing Party Parent BIC field <input type="checkbox"/> Instructing Party BIC field <input type="checkbox"/> Submit button	The Instructing Party BIC or Parent BIC specified in the Amendment Instruction is not valid on the current business date.	The Instructing Party BIC and Parent BIC indicated in an Amendment Instruction must be valid on the current business date.
MVDC026	<input type="checkbox"/> Instructing Party Parent BIC field <input type="checkbox"/> Instructing Party BIC field <input type="checkbox"/> Submit button	The Instructing Party specified in the Condition Modification Instruction does not exist in T2S Static Data.	The Instructing Party specified in a Condition Modification Instruction must exist in T2S Static Data.

Reference for error message	Field or Button	Error Text	Description
MVLI809	<input type="checkbox"/> Link Type field <input type="checkbox"/> Submit button	The instruction has a Settlement link indicator 'WITH' and the existing Linked Instruction is already settled.	If an Amendment Instruction tries to add a link 'WITH' to a Settlement Instruction or Settlement Restriction the linked Settlement Instruction or Settlement Restriction must not be 'Settled'.
MVLI810	<input type="checkbox"/> Link Type field <input type="checkbox"/> Link/Unlink field <input type="checkbox"/> Submit button	The instruction has a Settlement link indicator 'WITH' and the existing Linked Instruction is already cancelled.	If an Amendment Instruction tries to add a link 'WITH' to a Settlement Instruction or Settlement Restriction the linked Settlement Instruction or Settlement Restriction must not be 'Cancelled'.
MVLI811	<input type="checkbox"/> Link Type field <input type="checkbox"/> Link/Unlink field <input type="checkbox"/> Submit button	The instruction has a Settlement link indicator 'BEFORE' and the existing linked Settlement instruction is already settled.	If an Amendment Instruction tries to add a link 'BEFORE' to a Settlement Instruction or Settlement Restriction the linked Settlement Instruction or Settlement Restriction must not be 'Settled'.
MVLI825	<input type="checkbox"/> Link Type field <input type="checkbox"/> Link/Unlink field <input type="checkbox"/> Submit button	The instruction has a Settlement link indicator 'BEFORE' and the Settlement link indicator included in the existing linked instruction is 'WITH'.	If an Amendment Instruction intends to add a new link 'BEFORE' to a Settlement Instruction or Settlement Restriction, these latter must not have a previous link 'WITH' with the Settlement Instruction stated in the amendment (as linked instruction) un-

Reference for error message	Field or Button	Error Text	Description
			less they have the same Intended Settlement Date.
MVLI826	<ul style="list-style-type: none"> <input type="checkbox"/> Link Type field <input type="checkbox"/> Link/Unlink field <input type="checkbox"/> Submit button 	The instruction has a Settlement link indicator 'AFTER' and the Settlement link indicator included in the existing linked instruction is 'WITH'.	If an Amendment Instruction intends to add a new link 'AFTER' to a Settlement Instruction or Settlement Restriction, these latter must not have a previous link 'WITH' with the Settlement Instruction stated in the amendment (as linked instruction) unless they have the same Intended Settlement Date.
MVLI827	<ul style="list-style-type: none"> <input type="checkbox"/> Link Type field <input type="checkbox"/> Link/Unlink field <input type="checkbox"/> Submit button 	The instruction has a Settlement link indicator 'AFTER' and the Settlement link indicator included in the existing linked instruction is 'AFTER'.	If an Amendment Instruction intends to add a new link 'AFTER' to a Settlement Instruction or Settlement Restriction, these latter must not have a previous link 'AFTER' with the Settlement Instruction stated in the amendment (as linked instruction) unless they have the same Intended Settlement Date.
MVLI828	<ul style="list-style-type: none"> <input type="checkbox"/> Link Type field <input type="checkbox"/> Link/Unlink field <input type="checkbox"/> Submit button 	The instruction has a Settlement link indicator 'WITH' and the Settlement link indicator in-	If an Amendment Instruction intends to add a new link 'WITH' to a Settlement Instruction or Settlement Restriction, these latter must not have a previous link

Reference for error message	Field or Button	Error Text	Description
		cluded in the existing linked instruction is 'AFTER'.	'AFTER' with the Settlement Instruction stated in the amendment (as linked instruction) unless they have the same Intended Settlement Date.
MVLI829	<input type="checkbox"/> Link Type field <input type="checkbox"/> Link/Unlink field <input type="checkbox"/> Submit button	The instruction has a Settlement link indicator 'BEFORE' and the Settlement link indicator included in the existing linked instruction is 'BEFORE'.	If an Amendment Instruction intends to add a new link 'BEFORE' to a Settlement Instruction or Settlement Restriction, these latter must not have a previous link 'BEFORE' with the Settlement Instruction stated in the amendment (as linked instruction) unless they have the same Intended Settlement Date.
MVLI830	<input type="checkbox"/> Link Type field <input type="checkbox"/> Link/Unlink field <input type="checkbox"/> Submit button	The instruction has a Settlement link indicator 'WITH' and the Settlement link indicator included in the existing linked instruction is 'BEFORE'.	If an Amendment Instruction intends to add a new link 'WITH' to a Settlement Instruction or Settlement Restriction, these latter must not have a previous link 'BEFORE' with the Settlement Instruction stated in the amendment (as linked instruction) unless they have the same Intended Settlement Date.
MVLI837	<input type="checkbox"/> Link Type field <input type="checkbox"/> Link/Unlink field	The instruction has a Settlement link indicator 'BE-	If an Amendment Instruction tries to add a link 'BEFORE' to a Set-

Reference for error message	Field or Button	Error Text	Description
	<ul style="list-style-type: none"> <input type="checkbox"/> Submit button 	FORE' and the linked instruction's Intended Settlement Date is earlier than the validating instruction's Intended Settlement Date.	Amendment Instruction or Settlement Restriction, the Intended Settlement Date of the referenced Settlement Instruction or Settlement Restriction must be equal to or earlier than the Intended Settlement Date of the linked Settlement Instruction or Settlement Restriction, if this latter instruction is in T2S.
MVLI838	<ul style="list-style-type: none"> <input type="checkbox"/> Link Type field <input type="checkbox"/> Link/Unlink field <input type="checkbox"/> Submit button 	The instruction has a Settlement link indicator 'AFTER' and the linked instruction's Intended Settlement Date is later than the validating instruction's Intended Settlement Date.	If an Amendment Instruction tries to add a link 'AFTER' to a Settlement Instruction or Settlement Restriction, the Intended Settlement Date of the referenced Settlement Instruction or Settlement Restriction must be equal to or later than the Intended Settlement Date of the linked Settlement Instruction or Settlement Restriction, if this latter instruction is in T2S.
MVLI839	<ul style="list-style-type: none"> <input type="checkbox"/> Link Type field <input type="checkbox"/> Link/Unlink field <input type="checkbox"/> Submit button 	The instruction has a Settlement link indicator 'WITH' and the linked instruction's Intended Settlement Date is different.	If an Amendment Instruction tries to add a link 'WITH' to a Settlement Instruction or Settlement Restriction, the Intended Settlement Date of the referenced Settlement Instruction

Reference for error message	Field or Button	Error Text	Description
			or Settlement Restriction must be equal to the Intended Settlement Date of the linked Settlement Instruction or Settlement Restriction, if this latter instruction is in T2S.
MVLI853	<input type="checkbox"/> Link Type field <input type="checkbox"/> Link/Unlink field <input type="checkbox"/> Submit button	The instruction has a Settlement link indicator 'WITH' and the existing Linked Instruction is already partially settled.	If an Amendment Instruction intends to modify a Settlement Instruction or Settlement Restriction link 'WITH', the linked Settlement Instruction or Settlement Restriction must not be Partially Settled.
MVLI856	<input type="checkbox"/> Link Type field <input type="checkbox"/> Link/Unlink field <input type="checkbox"/> Submit button	The instruction has a Settlement link indicator 'BEFORE' and the existing Linked Instruction is already partially settled.	If an Amendment Instruction intends to modify a Settlement Instruction or Settlement Restriction link 'BEFORE', the linked Settlement Instruction or Settlement Restriction must not be 'Partially Settled'.
MVLI859	<input type="checkbox"/> Link Type field <input type="checkbox"/> Link/Unlink field <input type="checkbox"/> Submit button	The instruction has a Settlement link indicator 'AFTER' and the existing Linked Instruction is already partially settled.	If an Amendment Instruction intends to modify a Settlement Instruction or Settlement Restriction link 'AFTER', the linked Settlement Instruction or Settlement Restriction must not be 'Partially Settled'.

Reference for error message	Field or Button	Error Text	Description
MVLI862	<input type="checkbox"/> Link Type field <input type="checkbox"/> Link/Unlink field <input type="checkbox"/> Submit button	The instruction has a Settlement link indicator 'AFTER' and the existing Linked Instruction is already cancelled.	If an Amendment Instruction intends to modify a Settlement Instruction link 'AFTER', the linked Settlement Instruction or Settlement Restriction must not be 'Cancelled'.
MVLI871	<input type="checkbox"/> Link/Unlink field <input type="checkbox"/> Reference field <input type="checkbox"/> Submit button	The linked instruction referenced by a T2S Instruction Reference in the Amendment Instruction, does not exist in T2S.	If an Amendment Instruction intends to modify an instruction link, and the instruction is referenced by the T2S Instruction Reference, then the instruction must exist in T2S.
MVLI874	<input type="checkbox"/> Link Type field <input type="checkbox"/> Reference field <input type="checkbox"/> Submit button	The Processing Position must be specified in the Amendment Instruction.	If an Amendment Instruction intends to modify an instruction link, and the instruction is referenced by the T2S Instruction Reference or the T2S Actor Instruction Reference, then the Processing Position must be filled in.
MVRI555	<input type="checkbox"/> T2S Reference field <input type="checkbox"/> Submit button	The Condition Modification Instruction refers to a T2S generated Settlement Restriction.	A Condition Modification Instruction cannot refer to a T2S generated Settlement Restriction.
MVRI575	<input type="checkbox"/> T2S Reference field <input type="checkbox"/> Submit button	It is not possible to amend a T2S generated Settlement Instruction.	A Condition Modification Instruction cannot refer to a T2S generated Realignment Settlement Instruction, un-

Reference for error message	Field or Button	Error Text	Description
			less it is a CoSD Release Instruction and the T2S generated Settlement Instruction has its CoSD Hold Status Set to 'Yes' or it is a CSD Validation release instruction and the T2S generated Settlement Instruction has its CSD Validation Hold Status Set to 'Yes'.
MVRI591	<input type="checkbox"/> T2S Reference field <input type="checkbox"/> Submit button	The Condition Modification Instruction refers to a T2S generated Settlement Instruction.	A Condition Modification Instruction cannot refer to a T2S generated Collateral Settlement Instruction, unless it is a Release Instruction and the T2S generated Settlement Instruction is a Reimbursement Settlement Instruction.
MVSP209	<input type="checkbox"/> Instructing Party Parent BIC field <input type="checkbox"/> Instructing Party BIC field <input type="checkbox"/> Priority field <input type="checkbox"/> Submit button	'Reserved priority' not allowed for the Instructing Party Type (only CSDs can use it)	'Reserved priority' is allowed in an Amendment Instruction on a Settlement Instruction or Settlement Restriction on Securities only if the Instructing Party of the referenced instruction is a CSD.

6.5.2.10 Available Report - Current Settlement Day Cash Information (Following Settlement Day Cash Forecast) Report – Details Screen

△ [▶ 459]

No references for error messages.

6.5.2.11 Available Report - Details Screen

△ [▶ 457]

No references for error messages.

6.5.2.12 Available Report - Statement of Accounts - Details Screen

△ [▶ 464]

No references for error messages.

6.5.2.13 Available Report - Statement of Executed Amendment Instructions for Intra-Balance Movements - Details Screen

△ [▶ 467]

No references for error messages.

6.5.2.14 Available Report - Statement of Executed Amendment Instructions for Intra-Position Movements and Settlement Instructions - Details Screen

△ [▶ 472]

No references for error messages.

6.5.2.15 Available Report - Statement of Executed Cancellation Instructions for Intra-Balance Movements - Details Screen

△ [▶ 481]

No references for error messages.

6.5.2.16 Available Report - Statement of Executed Cancellation Instructions for Intra-Position Movements and Settlement Instructions - Details Screen

△ [▶ 485]

No references for error messages.

6.5.2.17 Available Report - Statement of Holdings - Details Screen

△ [▶ 493]

No references for error messages.

6.5.2.18 Available Report - Statement of Pending Amendment Instructions for Intra-Balance Movements - Details Screen

△ [▶ 498]

No references for error messages.

6.5.2.19 Available Report - Statement of Pending Amendment Instructions for Intra-Position Movements and Settlement Instructions - Details Screen

△ [▶ 503]

No references for error messages.

6.5.2.20 Available Report - Statement of Pending Cancellation Instructions for Intra-Balance Movements - Details Screen

△ [▶ 512]

No references for error messages.

6.5.2.21 Available Report - Statement of Pending Cancellation Instructions for Intra-Position Movements and Settlement Instructions - Details Screen

△ [▶ 516]

No references for error messages.

6.5.2.22 Available Report - Statement of Pending Instructions - Details Screen

△ [▶ 524]

No references for error messages.

6.5.2.23 Available Report - Statement of Pending Intra-Balance Movements - Details Screen

△ [▶ 533]

No references for error messages.

6.5.2.24 Available Report - Statement of Pending Intra-Position Movements - Details Screen

△ [▶ 538]

No references for error messages.

6.5.2.25 Available Report - Statement of Settled Intra-Balance Movements - Details Screen

△ [▶ 543]

No references for error messages.

6.5.2.26 Available Report - Statement of Settled Intra-Position Movements - Details Screen

△ [▶ 548]

No references for error messages.

6.5.2.27 Available Report - Statement of Settlement Allegements - Details Screen

△ [▶ 551]

No references for error messages.

6.5.2.28 Available Report - Statement of Transactions - Details Screen

△ [▶ 564]

No references for error messages.

6.5.2.29 Available Reports - Search/List Screen

△ [▶ 452]

Reference for error message	Field or Button	Error Text	Description
QMPC032	<input type="checkbox"/> Party BIC field <input type="checkbox"/> Search button	The specified Party BIC is not known in T2S.	In case a Party BIC is specified, it has to be known in T2S.
QMPC048	<input type="checkbox"/> Parent BIC field <input type="checkbox"/> Search button	The specified Parent BIC is not known in T2S.	In case a Parent BIC is specified, it has to be known in T2S.
QMPC055	<input type="checkbox"/> Date field <input type="checkbox"/> Search button	The specified business date is in the future.	In case a business date is specified, it must not be in the future.
QMPC084	<input type="checkbox"/> Parent BIC field <input type="checkbox"/> Party BIC field <input type="checkbox"/> Search button	The specified Parent BIC is not the System Entity of the specified party.	In case the BIC of a party as well as its parent BIC are specified, a party with these two BICs has to be known in T2S.

6.5.2.30 Broadcast - Details Screen

△ [▶ 620]

No references for error messages.

6.5.2.31 Broadcast - New Screen

△ [▶ 622]

No references for error messages.

6.5.2.32 Broadcasts - Search/List Screen

△ [▶ 617]

Reference for error message	Field or Button	Error Text	Description
QMPC015	<input type="checkbox"/> Creation Date and Time from field <input type="checkbox"/> Creation Date and Time to field <input type="checkbox"/> Search button	The Date From is after the Date To.	In case the Date is stated as a range, the Date From has to be before or equal to the Date To.

6.5.2.33 Calendar - Details Screen

△ [▶ 702]

No references for error messages.

6.5.2.34 Cancellation Cash Instruction - Details Screen

△ [▶ 417]

No references for error messages.

6.5.2.35 Cancellation Cash Instruction - New Screen

△ [▶ 420]

Reference for error message	Field or Button	Error Text	Description
MVDC027	<ul style="list-style-type: none"><input type="checkbox"/> Instructing Party Parent BIC field<input type="checkbox"/> Instructing Party BIC field<input type="checkbox"/> Submit button	The Instructing Party specified in the Cancellation Instruction does not exist in T2S Static Data.	The Instructing Party specified in a Cancellation Instruction must exist in T2S Static Data.
MVCP123	<ul style="list-style-type: none"><input type="checkbox"/> Instructing Party Parent BIC field<input type="checkbox"/> Instructing Party BIC field<input type="checkbox"/> Submit button	The sender of a Cancellation Instruction is not authorised to send a Cancellation Instruction using this Instructing Party.	If the sender of a Cancellation Instruction does not belong to the Instructing Party, then the sender of a Cancellation Instruction must be authorised to send a Cancellation Instruction using the Instructing Party.
MMCR201	<ul style="list-style-type: none"><input type="checkbox"/> Submit button	Referenced Settlement Restriction already settled.	The Settlement Status of a Settlement Restriction referenced by a Cancellation Instruction must not be 'Settled'.

Reference for error message	Field or Button	Error Text	Description
MMCR202	<input type="checkbox"/> Submit button	Referenced Settlement Restriction already cancelled.	The Cancellation Status of a Settlement Restriction referenced by a Cancellation Instruction must not be 'Cancelled'.
MVCP003	<input type="checkbox"/> T2S Reference field <input type="checkbox"/> Submit button	The underlying instruction referenced by a Cancellation Instruction does not exist in T2S.	The underlying instruction of a Cancellation instruction must exist in T2S.
MVCP035	<input type="checkbox"/> Dedicated Cash Account Number field <input type="checkbox"/> Submit Button	The sender of a Cancellation Instruction is not authorised to cancel a Settlement Restriction on Cash on the T2S Dedicated Cash Account.	The sender of a Cancellation Instruction that intends to cancel a Settlement Restriction on Cash must be authorised to cancel a Settlement Restriction on Cash on a specific T2S Dedicated Cash Account.
MVCV108	<input type="checkbox"/> Instructing Party Parent BIC field <input type="checkbox"/> Instructing Party BIC field <input type="checkbox"/> Submit button	The Instructing Party specified in the Cancellation Instruction is not open on the current business date.	The Instructing Party specified in a Cancellation Instruction must be open on the current business date.
MVCV231	<input type="checkbox"/> Instructing Party Parent BIC field <input type="checkbox"/> Instructing Party BIC field <input type="checkbox"/> Submit button	The Instructing Party BIC or Parent BIC specified in the Cancellation Instruction is not valid on the current business date.	The Instructing Party BIC and Parent BIC indicated in a Cancellation Instruction must be valid on the current business date.

6.5.2.36 Cancellation Securities Instruction - Details Screen

△ [▶ 113]

No references for error messages.

6.5.2.37 Cancellation Securities Instruction - New Screen

△ [▶ 117]

Reference for error message	Field or Button	Error Text	Description
MMCI101	<input type="checkbox"/> Submit button	Referenced Settlement Instruction already settled.	The Settlement Status of a Settlement Instruction referenced by a Cancellation Instruction must not be 'Settled'.
MMCI102	<input type="checkbox"/> Submit button	Referenced Settlement Instruction already cancelled.	The Cancellation Status of a Settlement Instruction referenced by a Cancellation Instruction must not be 'Cancelled'.
MMCI105	<input type="checkbox"/> Submit Button <input type="checkbox"/> Instructing Party BIC field <input type="checkbox"/> Instructing Party Parent BIC field	Referenced Settlement Instruction on CoSD process.	If a Settlement Instruction referenced by a Cancellation Instruction is identified as CoSD such Settlement Instruction cannot be cancelled by a Party.
MMCI106	<input type="checkbox"/> Submit Button <input type="checkbox"/> Instructing Party BIC field <input type="checkbox"/> Instructing Party Parent BIC field	Referenced Settlement Instruction already requested for cancellation by the same Instructing Party.	There is a pending Cancellation Instruction of the same type and Instructing Party (either T2S party, Administering Party or CSD).
MMCI107	<input type="checkbox"/> Submit Button <input type="checkbox"/> Instructing Party BIC field	Referenced Settlement Instruction already requested for cancellation.	The Cancellation Request Flag of a Settlement Instruction referenced by an unmatched

Reference for error message	Field or Button	Error Text	Description
	<input type="checkbox"/> Instructing Party Parent BIC field		T2S Party Cancellation Instruction must not be 'Yes'.
MMCI108	<input type="checkbox"/> Submit Button <input type="checkbox"/> Instructing Party BIC field <input type="checkbox"/> Instructing Party Parent BIC field	Referenced Settlement Instruction already requested for cancellation.	The Cancellation Request Flag of a Settlement Instruction referenced by a CoSD Cancellation Instruction must not be 'Yes'.
MMCI109	<input type="checkbox"/> Instructing Party Parent BIC field <input type="checkbox"/> Instructing Party BIC field	Realignment Instruction fulfils a CoSD Rule.	If a CoSD Rule applies over a Realignment Instruction of the referenced Settlement Instruction such Settlement Instruction can only be cancelled by the corresponding CSD.
MMCR201	<input type="checkbox"/> Submit button	Referenced Settlement Restriction already settled.	The Settlement Status of a Settlement Restriction referenced by a Cancellation Instruction must not be 'Settled'.
MMCR202	<input type="checkbox"/> Submit button	Referenced Settlement Restriction already cancelled.	The Cancellation Status of a Settlement Restriction referenced by a Cancellation Instruction must not be 'Cancelled'.
MVCP003	<input type="checkbox"/> Actor Reference field <input type="checkbox"/> T2S Reference field <input type="checkbox"/> Submit button	The underlying instruction referenced by a Cancellation Instruction does not exist in T2S.	The underlying instruction of a Cancellation instruction must exist in T2S.
MVCP029	<input type="checkbox"/> Securities Account field <input type="checkbox"/> Submit button	The sender of the Cancellation Instruction is not authorised to cancel	The sender of a Cancellation Instruction that intends to cancel a Settlement Instruction must

Reference for error message	Field or Button	Error Text	Description
		a Settlement Instruction on the Securities Account.	be authorised to cancel a Settlement Instruction on a specific Securities Account.
MVCP030	<input type="checkbox"/> Submit button	The sender of the Cancellation Instruction is not authorised to cancel a Settlement Instruction on behalf of an external CSD.	If the relevant Depository is an external CSD, the sender of a Cancellation Instruction that intends to cancel a Settlement Instruction must be authorised to cancel a Settlement Instruction on behalf of that external CSD.
MVCP031	<input type="checkbox"/> Submit button	The sender of the Cancellation Instruction is not authorised to cancel a CoSD Settlement Instruction on behalf of the Administering Party.	The sender of a Cancellation Instruction that intends to cancel a Settlement Instruction identified as CoSD must be authorised to cancel a CoSD Settlement Instruction on behalf of the Administering Party identified as the Instructing Party of the cancellation.
MVCP033	<input type="checkbox"/> Securities Account field <input type="checkbox"/> Submit button	The sender of a Cancellation Instruction is not authorised to cancel a Settlement Restriction on Securities on the Securities Account.	The sender of a Cancellation Instruction that intends to cancel a Settlement Restriction on Securities must be authorised to cancel a Settlement Restriction on Securities on a specific Securities Account.

Reference for error message	Field or Button	Error Text	Description
MVCP044	<input type="checkbox"/> Securities Account field <input type="checkbox"/> Submit button	The Securities Account informed in the instruction does not exist in T2S.	The Securities Account informed in the instruction must exist in T2S.
MVCP048	<input type="checkbox"/> Submit button	The sender of a Cancellation Instruction is not authorised to cancel non-modifiable Instructions on behalf of the Instructing party of the Underlying Settlement Instruction.	The sender of a Cancellation Instruction that intends to cancel a Settlement Instruction identified as a non-modifiable instruction must be authorised to cancel non-modifiable Instructions on behalf of the Instructing party of the Underlying Settlement Instruction.
MVCP096	<input type="checkbox"/> Submit button	The sender of a Cancellation Instruction is not authorised to cancel a Settlement Instruction on behalf of the parent CSD of the external CSD.	If the relevant Depository is an external CSD, the sender of a Cancellation Instruction that intends to cancel a Settlement Instruction must be authorised to cancel a Settlement Instruction on behalf of the parent CSD of the external CSD.
MVCP104	<input type="checkbox"/> Already Matched Cancellation field <input type="checkbox"/> Submit button	The sender of a Cancellation Instruction is not authorised to send a Cancellation Instruction on behalf of the external CSD of the coun-	If the Depository of the counterpart is an external CSD, the sender of a Cancellation Instruction that intends to cancel both legs of an already matched Settlement Instruction must be authorised to cancel a Settlement Instruction

Reference for error message	Field or Button	Error Text	Description
		terparty or the parent CSD of that external CSD.	on behalf of that external CSD or the parent CSD of that external CSD.
MVCP105	<input type="checkbox"/> Already Matched Cancellation field <input type="checkbox"/> Submit button	The sender of a Cancellation Instruction is not authorised to send a Cancellation Instruction on the Securities Account of the counterparty.	The sender of a Cancellation Instruction that intends to cancel both legs of an already matched Settlement Instruction must be authorised to cancel a Settlement Instruction on both Securities Accounts (in case the Cancellation Instruction only informs one Securities Account, the other would be derived from the underlying Settlement Instruction).
MVCP123	<input type="checkbox"/> Instructing Party BIC field <input type="checkbox"/> Instructing Party Parent BIC field <input type="checkbox"/> Submit button	The sender of a Cancellation Instruction is not authorised to send a Cancellation Instruction using this Instructing Party.	If the sender of a Cancellation Instruction does not belong to the Instructing Party, then the sender of a Cancellation Instruction must be authorised to send a Cancellation Instruction using the Instructing Party.
MVCV108	<input type="checkbox"/> Instructing Party BIC field <input type="checkbox"/> Instructing Party Parent BIC field <input type="checkbox"/> Submit button	The Instructing Party specified in the Cancellation Instruction is not open on the current business date.	The Instructing Party specified in a Cancellation Instruction must be open on the current business date.

Reference for error message	Field or Button	Error Text	Description
MVCV231	<ul style="list-style-type: none"> <input type="checkbox"/> Instructing Party BIC field <input type="checkbox"/> Instructing Party Parent BIC field <input type="checkbox"/> Submit button 	The Instructing Party BIC or Parent BIC specified in the Cancellation Instruction is not valid on the current business date.	The Instructing Party BIC and Parent BIC indicated in a Cancellation Instruction must be valid on the current business date.
MVDC027	<ul style="list-style-type: none"> <input type="checkbox"/> Instructing Party BIC field <input type="checkbox"/> Instructing Party Parent BIC field <input type="checkbox"/> Submit button 	The Instructing Party specified in the Cancellation Instruction does not exist in T2S Static Data.	The Instructing Party specified in a Cancellation Instruction must exist in T2S Static Data.
MVRI576	<ul style="list-style-type: none"> <input type="checkbox"/> Submit button 	It is not possible to cancel a T2S generated Settlement Instruction.	A Cancellation Instruction cannot refer to a T2S generated Settlement Instruction, unless the T2S generated Settlement Instruction is a recycled Reimbursement client-collateralization Settlement Instruction.
MVRI592	<ul style="list-style-type: none"> <input type="checkbox"/> Actor Reference field <input type="checkbox"/> T2S Reference field <input type="checkbox"/> Instructing Party BIC field <input type="checkbox"/> Instructing Party Parent BIC field <input type="checkbox"/> Submit button 	The underlying Settlement Instruction is not in CoSD Hold.	The underlying Settlement Instruction referred by a CoSD Cancellation Instruction must be CoSD on Hold.
MVRI594	<ul style="list-style-type: none"> <input type="checkbox"/> Instructing Party BIC field <input type="checkbox"/> Instructing Party Parent BIC field 	The Instructing Party is not an Administering Party of any CoSD Rule as-	The Instructing Party of a CoSD Cancellation Instruction must be an Administering Party of

Reference for error message	Field or Button	Error Text	Description
	<input type="checkbox"/> Submit button	sociated to the Settlement Instruction.	at least one of the CoSD Rules associated to the underlying Settlement Instruction.

6.5.2.38 Cash Forecast - Details Screen

△ [▶ 332]

No references for error messages.

6.5.2.39 Cash Forecasts - Search/List Screen

△ [▶ 324]

Reference for error message	Field or Button	Error Text	Description
QMPC017	<input type="checkbox"/> Intended Settlement Date field <input type="checkbox"/> Submit button	The Intended Settlement Date is not the current date or the date of the following settlement day.	The Intended Settlement Date must be the current date or the date of the following settlement day.
QMPC032	<input type="checkbox"/> Party BIC field <input type="checkbox"/> Submit button	The specified Party BIC is not known in T2S.	In case a Party BIC is specified, it has to be known in T2S.
QMPC048	<input type="checkbox"/> Parent BIC field <input type="checkbox"/> Submit button	The specified Parent BIC is not known in T2S.	In case a Parent BIC is specified, it has to be known in T2S.
QMPC054	<input type="checkbox"/> Currency field <input type="checkbox"/> Submit button	The specified Currency is not known in T2S.	In case a Currency is specified, it has to be known in T2S.
QMPC084	<input type="checkbox"/> Party BIC field <input type="checkbox"/> Parent BIC field <input type="checkbox"/> Submit button	The specified Parent BIC is not the System Entity of the specified party.	In case the BIC of a party as well as its parent BIC are specified, a party with these two BICs has to be known in T2S.

6.5.2.40 Collateral Value of a Security - Search/List Screen

△ [▶ 341]

Reference for error message	Field or Button	Error Text	Description
QMPC018	<input type="checkbox"/> ISIN field <input type="checkbox"/> Search button	The specified ISIN is not known in T2S.	In case an ISIN is specified, it has to be known in T2S.
QMPC031	<input type="checkbox"/> T2S Dedicated Cash Account Number field <input type="checkbox"/> Search button	The specified T2S Dedicated Cash Account Number is not known in T2S.	In case a T2S Dedicated Cash Account Number is specified, it has to be known in T2S.
QMPC032	<input type="checkbox"/> Party BIC field <input type="checkbox"/> CSD Parent BIC field <input type="checkbox"/> Search button	The specified Party BIC is not known in T2S.	In case a Party BIC is specified, it has to be known in T2S.
QMPC084	<input type="checkbox"/> Party BIC field <input type="checkbox"/> CSD Parent BIC field <input type="checkbox"/> Search button	The specified Parent BIC is not the System Entity of the specified party.	In case the BIC of a party as well as its parent BIC are specified, a party with these two BICs has to be known in T2S.

6.5.2.41 Collateral Value per T2S Dedicated Cash Account and Security - Search/List Screen

△ [▶ 345]

Reference for error message	Field or Button	Error Text	Description
QMPC031	<input type="checkbox"/> T2S Dedicated Cash Account Number field <input type="checkbox"/> Search button	The specified T2S Dedicated Cash Account Number is not known in T2S.	In case a T2S Dedicated Cash Account Number is specified, it has to be known in T2S.

Reference for error message	Field or Button	Error Text	Description
QMPC032	<input type="checkbox"/> Securities Account Owner BIC field <input type="checkbox"/> CSD Parent BIC field <input type="checkbox"/> Search button	The specified Party BIC is not known in T2S.	In case a Party BIC is specified, it has to be known in T2S.
QMPC084	<input type="checkbox"/> Securites Account Owner BIC field <input type="checkbox"/> CSD Parent BIC field <input type="checkbox"/> Search button	The specified Parent BIC is not the System Entity of the specified party.	In case the BIC of a party as well as its parent BIC are specified, a party with these two BICs has to be known in T2S.

6.5.2.42 Data Change - Details Screen

△ [▶ 612]

No references for error messages.

6.5.2.43 Data Changes - Search/List Screen

△ [▶ 608]

Reference for error message	Field or Button	Error Text	Description
QMPC015	<input type="checkbox"/> From field <input type="checkbox"/> Search button <input type="checkbox"/> To field	The Date From is after the Date To.	In case the Date is stated as a range, the Date From has to be before or equal to the Date To.
QMPC016	<input type="checkbox"/> From field <input type="checkbox"/> Search button	The Date From is older than three calendar months.	The Date From must not be older than three calendar months.

6.5.2.44 Default Event Schedule - Details Screen

△

No references for error messages.

6.5.2.45 Hold/Release Instruction - Details Screen

△ [▶ 122]

No references for error messages.

6.5.2.46 Hold/Release Instruction - New Screen

△ [▶ 126]

Reference for error message	Field or Button	Error Text	Description
MMHI101	<input type="checkbox"/> Submit button	Referenced Settlement Instruction already settled.	The Settlement Status of a Settlement Instruction referenced by a Hold Instruction must not be 'Settled'.
MMHI102	<input type="checkbox"/> Submit button	Referenced Settlement Instruction already cancelled.	The Cancellation Status of a Settlement Instruction referenced by a Hold Instruction must not be 'Cancelled'.
MMHI104	<input type="checkbox"/> Party Hold field <input type="checkbox"/> CSD Hold field <input type="checkbox"/> Submit button	Referenced Settlement Instruction already on hold or there is a pending Hold instruction of the same Hold type in the system.	The relevant Hold Status (Party Hold Status or CSD Hold Status) of a Settlement Instruction referenced by a Hold Instruction must not be 'Yes'. and there must not be a pending Hold instruction of the same Hold type to be executed in the system.
MMHI105	<input type="checkbox"/> Party Hold field <input type="checkbox"/> CSD Hold field <input type="checkbox"/> Submit button	Referenced Settlement Instruction is in a CoSD group.	The CoSD Flag of a Settlement Instruction referenced by a Hold Instruction must not be 'Yes'.
MMPR201	<input type="checkbox"/> CoSD Release field <input type="checkbox"/> Submit button	Referenced Settlement Instruction already settled.	The Settlement Status of a Settlement Instruction referenced by a

Reference for error message	Field or Button	Error Text	Description
			CoSD Release Instruction must not be 'Settled'.
MMPR202	<input type="checkbox"/> CoSD Release field <input type="checkbox"/> Submit button	Referenced Settlement Instruction already cancelled.	The Cancellation Status of a Settlement Instruction referenced by a CoSD Release Instruction must not be 'Cancelled'.
MMPR203	<input type="checkbox"/> CoSD Rule Identification field <input type="checkbox"/> CoSD Release field <input type="checkbox"/> Submit button	Waiting for CoSD cash blocking.	The cash position of a Settlement Instruction referenced by a CoSD Release Instruction must be blocked.
MMPR204	<input type="checkbox"/> CoSD Rule Identification field <input type="checkbox"/> CoSD Release field <input type="checkbox"/> Submit button	Waiting for CoSD securities blocking.	The securities position of a Settlement Instruction referenced by a CoSD Release Instruction must be blocked.
MMPR207	<input type="checkbox"/> CSD Validation Hold Status <input type="checkbox"/> Party Hold <input type="checkbox"/> CoSD Release field <input type="checkbox"/> Submit button	Any other Hold Status apart from the CoSD Hold Status is 'Yes'.	The Hold statuses, except the CoSD Hold Status, of a Settlement Instruction referenced by a CoSD Release Instruction or its matched Settlement Instruction, must be 'No'
MMPR208	<input type="checkbox"/> CoSD Rule Identification field <input type="checkbox"/> CoSD Release field <input type="checkbox"/> Submit button	CoSD Rule already released or there is a pending CoSD Release for this rule in the system.	The Administering Party has already requested the release of the CoSD Rule or the CoSD release for that CoSD rule is pending to be executed in the system.

Reference for error message	Field or Button	Error Text	Description
MMPR209	<ul style="list-style-type: none"> <input type="checkbox"/> CoSD Rule Identification field <input type="checkbox"/> CoSD Release field <input type="checkbox"/> Submit button 	Waiting for CoSD securities and cash blocking.	The securities and cash position of a Settlement Instruction referenced by a CoSD Release Instruction must be blocked.
MMRI201	<ul style="list-style-type: none"> <input type="checkbox"/> CoSD Release field <input type="checkbox"/> CSD Release field <input type="checkbox"/> CSD Validation Release field <input type="checkbox"/> Party Release field <input type="checkbox"/> Submit button 	Referenced Settlement Instruction already settled.	The Settlement Status of a Settlement Instruction referenced by a Release Instruction must not be 'Settled'.
MMRI202	<ul style="list-style-type: none"> <input type="checkbox"/> Party Release field <input type="checkbox"/> CSD Release field <input type="checkbox"/> CSD Validation Release field <input type="checkbox"/> CoSD Release field <input type="checkbox"/> Submit button 	Referenced Settlement Instruction already cancelled.	The Cancellation Status of a Settlement Instruction referenced by a Release Instruction must not be 'Cancelled'.
MMRI204	<ul style="list-style-type: none"> <input type="checkbox"/> Party Release field <input type="checkbox"/> CSD Release field <input type="checkbox"/> CSD Validation Release field <input type="checkbox"/> CoSD Release field <input type="checkbox"/> Submit button 	Referenced Settlement Instruction already released or there is a pending Release instruction of the same Hold type in the system.	The relevant Hold Status (Party Hold Status, CSD Hold Status or CSD Validation Hold Status) of a Settlement Instruction referenced by a Release Instruction must be 'Yes' and there must not be a pending Release instruction of the same Hold type to be executed in the system.

Reference for error message	Field or Button	Error Text	Description
MVCP004	<ul style="list-style-type: none"> <input type="checkbox"/> Actor Reference field <input type="checkbox"/> T2S Reference field <input type="checkbox"/> Submit button 	The underlying instruction referenced by a Condition Modification Instruction does not exist in T2S.	The underlying instruction of a Condition Modification instruction must exist in T2S.
MVCP019	<ul style="list-style-type: none"> <input type="checkbox"/> Party Hold field <input type="checkbox"/> Securities Account Number <input type="checkbox"/> Submit button 	The sender of the Hold/Release Instruction is not authorised to perform a Party Hold on the Securities Account.	The sender of a Hold/Release Instruction that intends to perform a Party Hold must be authorised to perform a Party Hold on a specific Securities Account.
MVCP020	<ul style="list-style-type: none"> <input type="checkbox"/> CSD Hold field <input type="checkbox"/> Securities Account Number <input type="checkbox"/> Submit button 	The sender of the Hold/Release Instruction is not authorised to perform a CSD Hold on the Securities Account.	The sender of a Hold/Release Instruction that intends to perform a CSD Hold must be authorised to perform a CSD Hold on a specific Securities Account.
MVCP021	<ul style="list-style-type: none"> <input type="checkbox"/> CSD Hold field <input type="checkbox"/> Submit button 	The sender of the Hold/Release Instruction is not authorised to perform a CSD Hold on behalf of an external CSD.	If the relevant Depository is an external CSD, the sender of a Hold/Release Instruction that intends to perform a CSD Hold must be authorised to perform a CSD Hold on behalf of the parent CSD of the external CSD.
MVCP022	<ul style="list-style-type: none"> <input type="checkbox"/> Party Release field <input type="checkbox"/> Submit button 	The sender of the Hold/Release Instruction is not authorised to release a Party Hold on the Securities Account.	The sender of a Hold/Release Instruction that intends to release a Party Hold must be authorised to release a Party Hold on a specific Securities Account.

Reference for error message	Field or Button	Error Text	Description
MVCP023	<input type="checkbox"/> CSD Release field <input type="checkbox"/> Submit button	The sender of the Hold/Release Instruction is not authorised to release a CSD Hold on the Securities Account.	The sender of a Hold/Release Instruction that intends to release a CSD Hold must be authorised to release a CSD Hold on a specific Securities Account.
MVCP024	<input type="checkbox"/> CSD Validation Release field <input type="checkbox"/> Submit button	The sender of the Hold/Release Instruction is not authorised to release a CSD Validation Hold on the Securities Account.	The sender of a Hold/Release Instruction that intends to release a CSD Validation Hold must be authorised to release a CSD Validation Hold on a specific Securities Account.
MVCP025	<input type="checkbox"/> CSD Release field <input type="checkbox"/> Submit button	The sender of the Hold/Release Instruction is not authorised to release a CSD Hold on behalf of the parent CSD of the external CSD.	If the relevant Depository is an external CSD, the sender of a Hold/Release Instruction that intends to release a CSD Hold must be authorised to release a CSD Hold on behalf of the parent CSD of the external CSD.
MVCP026	<input type="checkbox"/> CSD Validation Release field <input type="checkbox"/> Submit button	The sender of the Hold/Release Instruction is not authorised to release a CSD Validation Hold on behalf of the parent CSD of the external CSD.	If the relevant Depository is an external CSD, the sender of a Hold/Release Instruction that intends to release a CSD Validation Hold must be authorised to release a CSD Validation Hold on behalf of the parent CSD of the external CSD.

Reference for error message	Field or Button	Error Text	Description
MVCP043	<input type="checkbox"/> CoSD Rule field <input type="checkbox"/> CoSD Rule Identification field <input type="checkbox"/> Submit button	The sender of a Hold/Release Instruction is not authorised to release a CoSD Rule on Behalf of the Administering Party.	The sender of a Hold/Release Instruction that intends to release a CoSD Rule must be authorised to release a CoSD Rule on Behalf of the Administering Party of the rule.
MVCP044	<input type="checkbox"/> Securities Account Number <input type="checkbox"/> Submit button	The Securities Account informed in the instruction does not exist in T2S.	The Securities Account informed in the instruction must exist in T2S.
MVCP046	<input type="checkbox"/> Party Hold field <input type="checkbox"/> CSD Hold <input type="checkbox"/> Submit button	The sender of a Hold/Release Instruction is not authorised to hold non-modifiable Instructions on behalf of the Instructing party of the Underlying Settlement Instruction	The sender of a Hold/Release Instruction that intends to hold a Settlement Instruction identified as a non-modifiable instruction must be authorised to hold non-modifiable Instructions on behalf of the Instructing party of the Underlying Settlement Instruction
MVCP047	<input type="checkbox"/> Party Release field <input type="checkbox"/> CSD Release field <input type="checkbox"/> CSD Validation Release field <input type="checkbox"/> CoSD Release field <input type="checkbox"/> Submit button	The sender of a Hold/Release Instruction is not authorised to release non-modifiable Instructions on behalf of the Instructing party of the Underlying Settlement Instruction	The sender of a Hold/Release Instruction that intends to release a Settlement Instruction identified as a non-modifiable instruction must be authorised to release non-modifiable Instructions on behalf of the Instructing party of the Underlying Settlement Instruction

Reference for error message	Field or Button	Error Text	Description
MVCP093	<input type="checkbox"/> Party Hold field <input type="checkbox"/> Submit button	The sender of a Hold/Release Instruction is not authorised to perform a Party Hold on behalf of an external CSD.	If the relevant Depository is an external CSD, the sender of a Hold/Release Instruction that intends to perform a Party Hold must be authorised to perform a Party Hold on behalf of that external CSD.
MVCP094	<input type="checkbox"/> Party Release field <input type="checkbox"/> Submit button	The sender of a Hold/Release Instruction is not authorised to release a Party Hold on behalf of an external CSD.	If the relevant Depository is an external CSD, the sender of a Hold/Release Instruction that intends to perform a Release Party Hold must be authorised to release a Party Hold on behalf of that external CSD.
MVCP106	<input type="checkbox"/> Hold/Release Counterparty Instruction field <input type="checkbox"/> Party Hold field <input type="checkbox"/> Securities Account Number <input type="checkbox"/> Submit button	The sender of a Hold/Release Instruction is not authorised to perform a Party Hold on the Securities Account of the counterparty.	The sender of a Hold/Release Instruction that intends to perform a Party Hold on both legs of an already matched Settlement Instruction must be authorised to perform a Party Hold on the Securities Account of the counterparty (in case the Hold/Release Instruction only informs one Securities Account, the other would be derived from the underlying Settlement Instruction).

Reference for error message	Field or Button	Error Text	Description
MVCP107	<ul style="list-style-type: none"><input type="checkbox"/> Hold/Release Counterparty Instruction field<input type="checkbox"/> CSD Hold field<input type="checkbox"/> Securities Account Number<input type="checkbox"/> Submit button	The sender of a Hold/Release Instruction is not authorised to perform a CSD Hold on the Securities Account of the counterparty.	The sender of a Hold/Release Instruction that intends to perform a CSD Hold on both legs of an already matched Settlement Instruction must be authorised to CSD Hold a Settlement Instruction on the Securities Account of the counterparty (in case the Hold/Release Instruction only informs one Securities Account, the other would be derived from the underlying Settlement Instruction).
MVCP111	<ul style="list-style-type: none"><input type="checkbox"/> Hold/Release Counterparty Instruction field<input type="checkbox"/> Party Release field<input type="checkbox"/> Securities Account Number<input type="checkbox"/> Submit button	The sender of a Hold/Release Instruction is not authorised to release a Party Hold on the Securities Account of the counterparty.	The sender of a Hold/Release Instruction that intends to release a Party Hold on both legs of an already matched Settlement Instruction must be authorised to release Party Hold on a Settlement Instruction of the Securities Account of the counterparty (in case the Hold/Release Instruction only informs one Securities Account, the other would be derived from the underlying Settlement Instruction).

Reference for error message	Field or Button	Error Text	Description
MVCP112	<ul style="list-style-type: none"><input type="checkbox"/> Hold/Release Counterparty Instruction field<input type="checkbox"/> CSD Release field<input type="checkbox"/> Securities Account Number<input type="checkbox"/> Submit button	The sender of a Hold/Release Instruction is not authorised to release a CSD Hold on the Securities Account of the counterparty.	The sender of a Hold/Release Instruction that intends to release a CSD Hold on both legs of an already matched Settlement Instruction must be authorised to release a CSD Hold of a Settlement Instruction of the Securities Account of the counterparty (in case the Hold/Release Instruction only informs one Securities Account, the other would be derived from the underlying Settlement Instruction).
MVCP113	<ul style="list-style-type: none"><input type="checkbox"/> Hold/Release Counterparty Instruction field<input type="checkbox"/> CSD Validation Release field<input type="checkbox"/> Securities Account Number<input type="checkbox"/> Submit button	The sender of a Hold/Release Instruction is not authorized to release a CSD Validation Hold on the Securities Account of the counterparty.	The sender of a Hold/Release Instruction that intends to release a CSD Validation Hold on both legs of an already matched Settlement Instruction must be authorized to release a CSD Validation Hold of a Settlement Instruction on the Securities Account of the counterparty (in case the Hold/Release Instruction only informs one Securities Account, the other would be derived from the underlying Settlement Instruction).

Reference for error message	Field or Button	Error Text	Description
MVCP114	<ul style="list-style-type: none"><input type="checkbox"/> Hold/Release Counterparty Instruction field<input type="checkbox"/> Party Hold field<input type="checkbox"/> Submit button	The sender of a Hold/Release Instruction is not authorized to perform a Party Hold on behalf of the external CSD of the counterparty.	If the Depository of the counterpart is an external CSD, the sender of a Hold/Release Instruction that intends to perform a Party Hold on both legs of an already matched Settlement Instruction must be authorized to perform a Party Hold on behalf of that external CSD.
MVCP115	<ul style="list-style-type: none"><input type="checkbox"/> Hold/Release Counterparty Instruction field<input type="checkbox"/> CSD Hold field<input type="checkbox"/> Submit button	The sender of a Hold/Release Instruction is not authorized to perform a CSD Hold on behalf of the parent CSD of the external CSD of the counterparty.	If the Depository of the counterpart is an external CSD, the sender of a Hold/Release Instruction that intends to perform a CSD Hold on both legs of an already matched Settlement Instruction must be authorised to CSD Hold a Settlement Instruction on behalf of the parent CSD of that external CSD.
MVCP116	<ul style="list-style-type: none"><input type="checkbox"/> Hold/Release Counterparty Instruction field<input type="checkbox"/> Party Hold field<input type="checkbox"/> Submit button	The sender of a Hold/Release Instruction is not authorized to release a Party Hold on behalf of the external CSD of the counterparty.	If the Depository of the counterpart is an external CSD, the sender of a Hold/Release Instruction that intends to release a Party Hold on both legs of an already matched Settlement Instruction must be authorized to release

Reference for error message	Field or Button	Error Text	Description
			Party Hold of a Settlement Instruction on behalf that external CSD.
MVCP117	<ul style="list-style-type: none"> <input type="checkbox"/> Hold/Release Counterparty Instruction field <input type="checkbox"/> CSD Hold field <input type="checkbox"/> Submit button 	The sender of a Hold/Release Instruction is not authorized to release a CSD Hold on behalf of the parent CSD of the external CSD of the counterparty.	If the Depository of the counterparty is an external CSD, the sender of a Hold/Release Instruction that intends to release a CSD Hold on both legs of an already matched Settlement Instruction must be authorized to release a CSD Hold of a Settlement Instruction on behalf of the parent CSD of that external CSD.
MVCP118	<ul style="list-style-type: none"> <input type="checkbox"/> Hold/Release Counterparty Instruction field <input type="checkbox"/> CSD Validation Release field <input type="checkbox"/> Submit button 	The sender of a Hold/Release Instruction is not authorized to release a CSD Validation Hold on behalf of the parent CSD of the external CSD of the counterparty.	If the Depository of the counterparty is an external CSD, the sender of a Hold/Release Instruction that intends to release a CSD Validation Hold on both legs of an already matched Settlement Instruction must be authorized to release a CSD Validation Hold of a Settlement Instruction on behalf of the parent CSD of that external CSD.
MVCP121	<ul style="list-style-type: none"> <input type="checkbox"/> Instructing Party BIC field <input type="checkbox"/> Instructing Party Parent BIC field <input type="checkbox"/> Submit button 	The sender of a Hold/Release Instruction is not authorised to release a CSD Validation	The sender of a Hold/Release Instruction that intends to release a CSD Validation Hold on both legs of an already matched Settlement In-

Reference for error message	Field or Button	Error Text	Description
		Hold on the Securities Account of the counterparty.	struction must be authorised to release a CSD Validation Hold of a Settlement Instruction on the Securities Account of the counterparty (in case the Hold/Release Instruction only informs one Securities Account, the other would be derived from the underlying Settlement Instruction).
MVCP129	<input type="checkbox"/> Party Release field <input type="checkbox"/> Submit button	The sender of the Hold/Release Instruction is not authorised to release an Auto-Collateralisation Instruction on the Securities Account.	The sender of a Hold/Release Instruction that intends to release an Auto-Collateralisation Instruction must be authorised to release a Party Hold on an Auto-collateralisation Instruction with specific Securities Account.
MVCV109	<input type="checkbox"/> Instructing Party BIC field <input type="checkbox"/> Instructing Party Parent BIC field <input type="checkbox"/> Submit button	The Instructing Party specified in the Hold/Release Instruction is not open on the current business date.	The Instructing Party specified in a Hold/Release Instruction must be open on the current business date.
MVCV233	<input type="checkbox"/> Instructing Party BIC field <input type="checkbox"/> Instructing Party Parent BIC field <input type="checkbox"/> Submit button	The Instructing Party BIC or Parent BIC specified in the Hold/Release Instruction is not valid on the current business date.	The Instructing Party BIC and Parent BIC indicated in a Hold/Release Instruction must be valid on the current business date.

Reference for error message	Field or Button	Error Text	Description
MVDC026	<ul style="list-style-type: none"> <input type="checkbox"/> Instructing Party BIC field <input type="checkbox"/> Instructing Party Parent BIC field <input type="checkbox"/> Submit button 	The Instructing Party specified in the Condition Modification Instruction does not exist in T2S Static Data.	The Instructing Party specified in a Condition Modification Instruction must exist in T2S Static Data.
MVRI555	<ul style="list-style-type: none"> <input type="checkbox"/> T2S Reference <input type="checkbox"/> Submit button 	The Condition Modification Instruction refers to a T2S generated Settlement Restriction.	A Condition Modification Instruction cannot refer to a T2S generated Settlement Restriction.
MVRI556	<ul style="list-style-type: none"> <input type="checkbox"/> Submit button 	The Cancellation Instruction refers to a T2S generated Settlement Restriction.	A Cancellation Instruction cannot refer to a T2S generated Settlement Restriction.
MVRI571	<ul style="list-style-type: none"> <input type="checkbox"/> CoSD Rule field <input type="checkbox"/> CoSD Rule Identification field <input type="checkbox"/> Submit button 	The CoSD rule reference is not informed in the CoSD Release Instruction.	The CoSD Rule reference must be specified in a CoSD Release Instruction.
MVRI572	<ul style="list-style-type: none"> <input type="checkbox"/> CoSD Rule field <input type="checkbox"/> CoSD Rule Identification field <input type="checkbox"/> Submit button 	The CoSD rule reference specified in the Release Instruction does not exist in T2S for the Settlement Instruction specified.	The CoSD Rule reference specified in a CoSD Release Instruction must exist in T2S for the Settlement Instruction stated in the Release Instruction.
MVRI575	<ul style="list-style-type: none"> <input type="checkbox"/> T2S Reference <input type="checkbox"/> CSD Validation Hold Status <input type="checkbox"/> CoSD Hold Status <input type="checkbox"/> Submit button 	It is not possible to amend a T2S generated Settlement Instruction.	A Condition Modification Instruction cannot refer to a T2S generated Realignment Settlement Instruction, unless it is a CoSD Release Instruction and

Reference for error message	Field or Button	Error Text	Description
			the T2S generated Settlement Instruction has its CoSD Hold Status Set to 'Yes' or it is a CSD.
MVRI584	<ul style="list-style-type: none"> <input type="checkbox"/> Instructing Party BIC field <input type="checkbox"/> Instructing Party Parent BIC field <input type="checkbox"/> CoSD Release field <input type="checkbox"/> CoSD Rule field <input type="checkbox"/> CoSD Rule Identification field <input type="checkbox"/> T2S Reference <input type="checkbox"/> Submit button 	The T2S Instruction Id of a Settlement Instruction referenced by a CoSD Release Instruction is not informed.	When the Instructing Party of a CoSD Release Instruction is an Administering Party, the T2S Instruction Id of the underlying Settlement Instruction must be informed.
MVRI591	<ul style="list-style-type: none"> <input type="checkbox"/> Actor Reference field <input type="checkbox"/> T2S Reference field <input type="checkbox"/> Party Release field <input type="checkbox"/> CSD Release field <input type="checkbox"/> CSD Validation Release field <input type="checkbox"/> CoSD Release field <input type="checkbox"/> Submit button 	The Condition Modification Instruction refers to a T2S generated Settlement Instruction.	A Condition Modification Instruction cannot refer to a T2S generated Collateral Settlement Instruction, unless it is a Release Instruction and the T2S generated Settlement Instruction is a Reimbursement Settlement Instruction.
MVRI593	<ul style="list-style-type: none"> <input type="checkbox"/> Actor Reference field <input type="checkbox"/> T2S Reference field <input type="checkbox"/> CoSD Release field <input type="checkbox"/> CoSD Hold Status 	The underlying Settlement Instruction is not in CoSD Hold.	The underlying Settlement Instruction referred by a CoSD Release Instruction must be in CoSD Hold

Reference for error message	Field or Button	Error Text	Description
	<input type="checkbox"/> Submit button		
MVRI595	<input type="checkbox"/> Instructing Party BIC field <input type="checkbox"/> Instructing Party Parent BIC field <input type="checkbox"/> CoSD Release field <input type="checkbox"/> CoSD Rule field <input type="checkbox"/> CoSD Rule Identification field <input type="checkbox"/> Submit button	The Instructing Party is not the Administering Party of the CoSD Rule specified in the Condition Modification Instruction.	The Instructing Party of a CoSD Release Instruction must be the Administering Party of the CoSD Rule specified in the condition modification message.
MVRI598	<input type="checkbox"/> Released Quantity <input type="checkbox"/> Submit button	The Settlement Quantity of a Party Release Instruction is zero or higher than the Settlement Quantity of the referenced instruction.	If present, the Settlement Quantity indicated in a Party Release Instruction must be equal or lower than the Settlement Quantity stated in the referenced Settlement Instruction.
MVRI599	<input type="checkbox"/> Released Quantity <input type="checkbox"/> Submit button	The Settlement Quantity of a Party Release Instruction is not a multiple of the Settlement Unit Multiple	If present, the Settlement Quantity indicated in a Party Release Instruction must be equal or lower than the Settlement Quantity stated in the referenced Settlement Instruction.
MVRI600	<input type="checkbox"/> Released Quantity <input type="checkbox"/> Submit button	The number of decimals of the Settlement Quantity of a Party Release Instruction is greater than the number of decim-	If present, the number of decimals of the Settlement Quantity of a Party Release Instruction must be equal or lower than the number of decimals of the Settlement Unit Multiple of the related Security

Reference for error message	Field or Button	Error Text	Description
		als of the Settlement Multiple of the related security	
MVRI601	<input type="checkbox"/> Released Quantity <input type="checkbox"/> Submit button	The Settlement Quantity stated in the Party Release Instruction is not expressed using the same Settlement Type specified in T2S Reference Data.	If present, the Settlement Quantity stated in a Party Release Instruction must be expressed using the same Settlement Type as the one specified in T2S Reference Data for the ISIN Code of the referenced Settlement Instruction
MVRI602	<input type="checkbox"/> Submit button	The Intended Settlement Day of the referenced Settlement Instruction has not been reached yet.	If the quantity present in a Release Instruction is lower than the Settlement Quantity stated in the referenced Settlement Instruction, the Intended Settlement Date of the referenced Settlement Instruction must have been reached
MVRI603	<input type="checkbox"/> Submit button	The Securities Movement type of Referenced Settlement Instruction is not 'DELI'	If the quantity present in a Release Instruction is lower than the Settlement Quantity stated in the referenced Settlement Instruction, the Securities Movement Type of the referenced Settlement Instruction must be 'DELI'
MVRI604	Submit button	The referenced Settlement Instruction of a Party Re-	If the quantity present in a Release Instruction is lower than the Settlement-

Reference for error message	Field or Button	Error Text	Description
		lease instruction is a T2S generated Settlement Instruction	ment Quantity stated in the referenced Settlement Instruction, the referenced Settlement Instruction must not be a T2S generated Settlement Instruction
SPSA001	<input type="checkbox"/> Released Quantity <input type="checkbox"/> Submit button	Partial release instruction is denied because the relevant cut-off has been reached.	If the quantity present in a release Instruction is Lower than the settlement quantity stated in the referenced settlement instruction, the related cut-off must not have been reached.
SPSA002	<input type="checkbox"/> Released Quantity <input type="checkbox"/> Submit button	Partial release instruction is denied because it does not comply with partial settlement rules.	If the quantity present in a release instruction is lower than the settlement quantity stated in the referenced settlement instruction, it must comply with partial settlement rules.
SPSA019	<input type="checkbox"/> Released Quantity <input type="checkbox"/> Submit button	At least one associated realignment Settlement Instruction is on hold.	If the quantity present in a Release Instruction is lower than the Settlement Quantity stated in the referenced Settlement Instruction, none of the associated realignment Settlement Instruction must be submitted to any hold

6.5.2.47 Immediate Liquidity Transfer Order - Details Screen

△ [▶ 382]

No references for error messages.

6.5.2.48 Immediate Liquidity Transfer Order - New Screen

△ [▶ 387]

Reference for error message	Field or Button	Error Text	Description
LLCI002	<ul style="list-style-type: none"><input type="checkbox"/> T2S Dedicated Cash Account Number field (Debit)<input type="checkbox"/> Submit button	Source (Debit) Account of internal or outbound LT is neither an existing nor an active T2S DCA.	The Source Account (debit account) of an immediate internal or outbound Liquidity Transfer should be an existing and active T2S Dedicated Cash Account (neither blocked nor logically deleted and for an Outbound Liquidity Transfer no RTGS Dedicated Transit Account) otherwise the incoming internal or outbound Liquidity Transfer will be rejected.
LLCI003	<ul style="list-style-type: none"><input type="checkbox"/> External RTGS Account Number field<input type="checkbox"/> T2S Dedicated Cash Account Number field (Credit)<input type="checkbox"/> Submit button	Target (Credit) Account of internal or outbound LT is neither an existing nor an active T2S DCA or RTGS Account.	The Target Account (credit account) of an internal or outbound Liquidity Transfer should be an existing and active T2S Dedicated Cash Account (neither blocked nor logically deleted) or an active RTGS account known within T2S, otherwise the incoming Liquidity Transfer will be rejected.

Reference for error message	Field or Button	Error Text	Description
LLCI005	<ul style="list-style-type: none"> <input type="checkbox"/> Amount field <input type="checkbox"/> Submit button 	No eligible T2S settlement currency.	The currency of an inbound, outbound or internal Liquidity Transfer should be eligible as T2S settlement currency; otherwise the Liquidity Transfer will be rejected.
LLCI006	<ul style="list-style-type: none"> <input type="checkbox"/> T2S Dedicated Cash Account Number field (Debit) <input type="checkbox"/> Amount field <input type="checkbox"/> External RTGS Account Number field <input type="checkbox"/> T2S Dedicated Cash Account Number field (Credit) <input type="checkbox"/> Submit button 	Currency of incoming flow differs from Target Account currency.	The currency of the incoming flow should be the same as the currency of the target account; otherwise the incoming internal, outbound or inbound liquidity transfer will be rejected.
LLCI007	<ul style="list-style-type: none"> <input type="checkbox"/> T2S Dedicated Cash Account Number field (Debit) <input type="checkbox"/> T2S Dedicated Cash Account Number field (Credit) <input type="checkbox"/> User Reference field <input type="checkbox"/> Amount field <input type="checkbox"/> External RTGS Account Number field <input type="checkbox"/> Submit button 	Incoming Internal, Outbound or Inbound LT is a duplicate submission.	If the incoming Internal, outbound or Inbound Liquidity Transfer from a T2S Actor has the same Order Reference, refers to the same Debit and Credit Account and has the same instructed Amount as another Internal, Outbound or Inbound Liquidity Transfer from the same T2S Actor, then it is a duplicate submission. The

Reference for error message	Field or Button	Error Text	Description
			second and any further submission will be rejected.
LLCI008	<ul style="list-style-type: none"> <input type="checkbox"/> External RTGS Account Number field <input type="checkbox"/> T2S Dedicated Cash Account Number field (Credit) <input type="checkbox"/> T2S Dedicated Cash Account Number field (Debit) <input type="checkbox"/> Submit button 	Source and Target Account of Internal LT not linked to same RTGS Account or do not belong to same payment bank.	<p>Internal Liquidity Transfers are possible between T2S Dedicated Cash Accounts</p> <ul style="list-style-type: none"> <input type="checkbox"/> linked to the same RTGS account or <input type="checkbox"/> belonging to the same payment bank or <input type="checkbox"/> if both accounts are T2S Central Bank accounts or <input type="checkbox"/> if one of the accounts is a T2S Central Bank account <p>If this is not the case the Internal Liquidity Transfer will be rejected.</p> <p>This rule is not applicable if one of the involved accounts is a Dedicated Transit Account.</p>
LLCI009	<ul style="list-style-type: none"> <input type="checkbox"/> Submit button 	LT sent between Liquidity Transfer cut off and Business Date Change.	Any Liquidity Transfer arriving in T2S after the Business date change and prior to the Liquidity Transfer cut-off is processed; otherwise the incoming Liquidity Transfer will be rejected.

Reference for error message	Field or Button	Error Text	Description
			ted. This business rule is not applicable for internal Liquidity Transfers between a RTGS Dedicated Transit Account and a Dedicated Cash Account. In case of delays in the Start of Day incoming Inbound Liquidity Transfers will be parked until the new business date is reached.
LLCI010	<ul style="list-style-type: none"><input type="checkbox"/> T2S Dedicated Cash Account Number field (Credit)<input type="checkbox"/> Submit button	Instructing Party of an Internal LT crediting an RTGS DTA is not identical with the Account holder in case of rebooking.	If the Target Account of an Internal Liquidity Transfer is an RTGS Dedicated Transit Account in case of rebooking, the Instructing Party should be identical with the Account holder.
LLCI012	<ul style="list-style-type: none"><input type="checkbox"/> Amount field<input type="checkbox"/> Submit button	More digits after the decimal point than maximally foreseen for the currency.	The amount of the incoming flow should only contain the maximum number of digits after the decimal point as foreseen for the respective currency; otherwise the incoming Liquidity Transfer will be rejected.
LLCI014	<ul style="list-style-type: none"><input type="checkbox"/> Amount field<input type="checkbox"/> Submit button	The amount is lower or equal to zero.	The amount must be greater than zero.

Reference for error message	Field or Button	Error Text	Description
LLCI015	<ul style="list-style-type: none"> <input type="checkbox"/> Amount field <input type="checkbox"/> External RTGS Account Number field <input type="checkbox"/> T2S Dedicated Cash Account Number field (Credit) <input type="checkbox"/> T2S Dedicated Cash Account Number field (Debit) <input type="checkbox"/> Submit button 	Currency of Source Account differs from Target Account currency.	The currency of the Source Account should be the same as the currency of the Target Account; otherwise the incoming Internal or Outbound Liquidity Transfer will be rejected.
LLCI016	<ul style="list-style-type: none"> <input type="checkbox"/> User Reference field <input type="checkbox"/> Submit button 	Missing code word for processing during weekend	The incoming Liquidity Transfer entered the system during the weekend and does not contain the required code word.
LLCI017	<ul style="list-style-type: none"> <input type="checkbox"/> User Reference field <input type="checkbox"/> Submit button 	Reference can only contain up to 16 characters.	When performing a Liquidity Transfer for a non-Euro currency references may only contain up to 16 characters.
LLCP001	<ul style="list-style-type: none"> <input type="checkbox"/> T2S Dedicated Cash Account Number field (Debit) 	Missing privilege to debit the T2S dedicated cash account.	The T2S system User must be allowed to act for the account to be debited with a Liquidity Transfer.

6.5.2.49 Immediate Liquidity Transfer Orders - Search/List Screen

△ [▶ 374]

Reference for error message	Field or Button	Error Text	Description
QMPC015	<input type="checkbox"/> Settlement Date and Time - from field <input type="checkbox"/> Settlement Date and Time - to field <input type="checkbox"/> Settlement Date and Time field <input type="checkbox"/> Search button	The lower limit of the Cash Amount range is more than the upper limit of the Cash Amount range.	In case the Cash Amount is stated as a range, the lower limit of the Cash Amount range must be less than the upper limit of the Cash Amount range.
QMPC016	<input type="checkbox"/> Settlement Date and Time - from field <input type="checkbox"/> Settlement Date and Time - to field <input type="checkbox"/> Settlement Date and Time field	The Date From is older than three calendar months.	The Date From must not be older than three calendar months.
QMPC031	<input type="checkbox"/> T2S Dedicated Cash Account Number field <input type="checkbox"/> Search button	The specified T2S Dedicated Cash Account Number is not known in T2S.	In case a T2S Dedicated Cash Account Number is specified, it has to be known in T2S.
QMPC032	<input type="checkbox"/> Party BIC field <input type="checkbox"/> Search button	The specified Party BIC is not known in T2S.	In case a Party BIC is specified, it has to be known in T2S.
QMPC054	<input type="checkbox"/> Currency field <input type="checkbox"/> Search button	The specified Currency is not known in T2S.	In case a Currency is specified, it has to be known in T2S.
QMPC072	<input type="checkbox"/> Currency field <input type="checkbox"/> Parent BIC field <input type="checkbox"/> Party BIC field <input type="checkbox"/> T2S Dedicated Cash Account Number field <input type="checkbox"/> Search button	The specified combination of T2S Dedicated Cash Account Number, Currency, Account Owner and Account Servicer are not consistent.	In case at least two of the following selection criteria are specified, they have to be consistent, i. e. the T2S Dedicated Cash Account is owned by the specified Party <ul style="list-style-type: none"> • T2S Dedicated Cash Account Number

Reference for error message	Field or Button	Error Text	Description
			<ul style="list-style-type: none"> • Account Owner • Account Servicer • Currency, in which the T2S Dedicated Cash Account is issued and/ or in which the Party owns T2SDedicated Cash Accounts
QMPC084	<input type="checkbox"/> Parent BIC field <input type="checkbox"/> Party BIC field <input type="checkbox"/> Search button	The specified Parent BIC is not the System Entity of the specified party.	In case the BIC of a party as well as its parent BIC are specified, a party with these two BICs has to be known in T2S.
QMPC097	<input type="checkbox"/> Settlement Date and Time - to field <input type="checkbox"/> Settlement Date and Time field	In case a Date To is specified, it must not be older than three calendar months.	The Date To is older than three calendar months.

6.5.2.50 Inbound File - Details Screen

△ [▶ 626]

No references for error messages.

6.5.2.51 Inbound Files - Search/List Screen

△ [▶ 623]

Reference for error message	Field or Button	Error Text	Description
QMPC015	<input type="checkbox"/> Entry Date and Time from field <input type="checkbox"/> Entry Date and Time to field <input type="checkbox"/> Search button	The Date From is after the Date To.	In case the Date is stated as a range, the Date From has to be before or equal to the Date To.

Reference for error message	Field or Button	Error Text	Description
QMPC073	<input type="checkbox"/> Entry Date and Time from field <input type="checkbox"/> Search button	The specified Date is in the future.	In case a date from is specified, it must not be in the future.

6.5.2.52 Inbound Message - Details Screen

△ [▶ 636]

No references for error messages.

6.5.2.53 Inbound Messages - Search/List Screen

△ [▶ 629]

Reference for error message	Field or Button	Error Text	Description
QMPC015	<input type="checkbox"/> Entry Date and Time from field <input type="checkbox"/> Entry Date and Time to field <input type="checkbox"/> Search button	The Date From is after the Date To.	In case the Date is stated as a range, the Date From has to be before or equal to the Date To.
QMPC073	<input type="checkbox"/> Entry Business Date from field <input type="checkbox"/> Search button	The specified Date is in the future.	In case a date from is specified, it must not be in the future.

6.5.2.54 Insolvency procedure Settlement Instructions- Search/List Screen

△ [▶ 270]

Reference for error message	Field or Button	Error Text	Description
QMPC015	<input type="checkbox"/> Acceptance Date and Time – from field <input type="checkbox"/> Acceptance Date and Time – to field	The Date From is after the Date To.	In case the Date is stated as a range, the Date From has to be before or equal to the Date To.

Reference for error message	Field or Button	Error Text	Description
	<input type="checkbox"/> Matching Date and Time – from field <input type="checkbox"/> Matching Date and Time – to field <input type="checkbox"/> Submit button		
QMPC030	<input type="checkbox"/> Securities Account Number field <input type="checkbox"/> Submit button	The specified Securities Account Number is not known in T2S.	In case a Securities Account Number is specified, it has to be known in T2S.
QMPC031	<input type="checkbox"/> Dedicated Cash Account Number field <input type="checkbox"/> Submit button	The specified T2S Dedicated Cash Account Number is not known in T2S.	In case a T2S Dedicated Cash Account Number is specified, it has to be known in T2S.
QMPC032	<input type="checkbox"/> Insolvent Party BIC field <input type="checkbox"/> Submit button	The specified Party BIC is not known in T2S.	In case a Party BIC is specified, it has to be known in T2S.
QMPC048	<input type="checkbox"/> Insolvent Parent Party BIC field <input type="checkbox"/> Submit button	The specified Parent BIC is not known in T2S.	In case a Parent BIC is specified, it has to be known in T2S.
QMPC084	<input type="checkbox"/> Insolvent Party BIC field <input type="checkbox"/> Insolvent Parent Party BIC field <input type="checkbox"/> Submit button	The specified Parent BIC is not the System Entity of the specified party.	In case the BIC of a party as well as its parent BIC are specified, a party with these two BICs has to be known in T2S.

6.5.2.55 Intra-Balance Movement - Details Screen

△ [▶ 430]

No references for error messages.

6.5.2.56 Intra-Balance Movement - New Screen

△ [▶ 437]

Reference for error message	Field or Button	Error Text	Description
MVCA106	<input type="checkbox"/> Amount field <input type="checkbox"/> Submit button <input type="checkbox"/> Currency field	The Currency of the Settlement Restriction is not the same as the Currency of the T2S Dedicated Cash Account.	The Currency of a Settlement Restriction on cash must be the same as the Currency of the T2S Dedicated Cash Account.
MVCA508	<input type="checkbox"/> Intended Settlement Date field <input type="checkbox"/> T2S Dedicated Cash Account Number field <input type="checkbox"/> Submit button	The T2S Dedicated Cash Account is not open on the Settlement Date.	The T2S Dedicated Cash Account specified in a Settlement Restriction on cash must be open on the Intended Settlement Date and additionally on the current Business Day if the Intended Settlement Date is in the past.
MVCA512	<input type="checkbox"/> T2S Dedicated Cash Account Number field <input type="checkbox"/> Submit button <input type="checkbox"/> Account Owner BIC field <input type="checkbox"/> T2S Dedicated Cash Account Owner field	The Account Owner Party BIC of the Settlement Restriction is not the Account Owner of the T2S Dedicated Cash Account	The Account Owner Party BIC of the Settlement Restriction on Cash must be the Account Owner derived from the T2S Dedicated Cash Account in Static Data.
MVCP017	<input type="checkbox"/> T2S Dedicated Cash Account Number field <input type="checkbox"/> Submit button	The sender of the Settlement Restriction on Cash is not authorised to send a Settlement Restriction on Cash on the T2S Dedicated Cash Account.	The sender of a Settlement Restriction on Cash must be authorised to send a Settlement Restriction on Cash on a specific T2S Dedicated Cash Account.

Reference for error message	Field or Button	Error Text	Description
MVCP018	<ul style="list-style-type: none"> <input type="checkbox"/> Submit button <input type="checkbox"/> Link Type <input type="checkbox"/> Pool Instruction Reference 	The sender of the Settlement Restriction on Cash is not authorised to link to an instruction/pool belonging to another party.	In case a Settlement Restriction on Cash intends to link to another instruction or pool, the sender of the Settlement Restriction on Cash must be authorised to link to an instruction/pool belonging to a specific party.
MVCP045	<ul style="list-style-type: none"> <input type="checkbox"/> Submit button <input type="checkbox"/> T2S Dedicated Cash Account Number field 	The T2S Dedicated Cash Account informed in the instruction does not exist in T2S.	The T2S Dedicated Cash Account informed in the instruction must exist in T2S.
MVCP098	<ul style="list-style-type: none"> <input type="checkbox"/> Submit button <input type="checkbox"/> Restriction Type – Balance From field 	The sender of the Settlement Restriction on Cash is not authorised to unblock a CoSD Cash Blocking on behalf of the CSD.	The sender of a Settlement Restriction on Cash that tries to unblock a CoSD Cash Blocking must be authorised to send a Settlement Restriction on Cash to unblock a CoSD Cash Blocking on behalf of the relevant CSD in T2S (i.e. CSD of the debiting Settlement Instruction on whose T2S Dedicated Cash Account the cash is blocked).
MVCP099	<ul style="list-style-type: none"> <input type="checkbox"/> Reference Type field <input type="checkbox"/> Reference field <input type="checkbox"/> Submit button 	The Reference Owner of the Linked Instruction does not belong to the CSD (parent CSD in case of an	If a T2S actor wants to make use of linkages across several instructions sent to T2S via different CSDs or NCBs he holds accounts with,

Reference for error message	Field or Button	Error Text	Description
		external CSD) or NCB of the Instructing Party.	the T2S actor has to make use of the T2S reference.
MVCP120	<input type="checkbox"/> Instructing Party BIC field <input type="checkbox"/> Instructing Party Parent BIC field <input type="checkbox"/> Submit button	The sender of a Settlement Restriction is not authorised to send a Settlement Restriction using this Instructing Party.	If the sender of a Settlement Restriction does not belong to the Instructing Party, then the sender of a Settlement Restriction must be authorised to send a Settlement Restriction using the Instructing Party.
MVCU102	<input type="checkbox"/> Currency field <input type="checkbox"/> Submit button	The Currency of the Settlement Restriction does not exist in T2S.	The Currency of a Settlement Restriction on cash must exist in T2S.
MVCU104	<input type="checkbox"/> Currency field <input type="checkbox"/> Submit button	The Currency of the Settlement Restriction is not a T2S Settlement Currency.	The Currency of a Settlement Restriction on cash must be a T2S Settlement Currency.
MVCU108	<input type="checkbox"/> Amount field <input type="checkbox"/> Settlement Amount field <input type="checkbox"/> Submit button	The number of decimals of the Settlement Amount of the Settlement Restriction exceeds the number of decimals defined in T2S for the Currency stated in the Settlement Restriction.	The number of decimals of the Settlement Amount of a Settlement Restriction on cash cannot exceed the number of decimals defined T2S for the Currency stated in the Settlement Restriction.
MVCV110	<input type="checkbox"/> Instructing Party BIC field	The Instructing Party specified in the Settlement Re-	The Instructing Party specified in a Settlement Restriction must

Reference for error message	Field or Button	Error Text	Description
	<ul style="list-style-type: none"> <input type="checkbox"/> Instructing Party Parent BIC field <input type="checkbox"/> Submit button <input type="checkbox"/> Intended settlement date 	striction is not open on the settlement date.	be open on the Intended Settlement Date and additionally on the current Business Day if the Intended Settlement Date is in the past.
MVCV230	<ul style="list-style-type: none"> <input type="checkbox"/> Instructing Party BIC field <input type="checkbox"/> Instructing Party Parent BIC field <input type="checkbox"/> Intended Settlement Date field <input type="checkbox"/> Submit button 	The Instructing Party BIC or Parent BIC specified in the Settlement Restriction is not valid on the settlement date.	The Instructing Party BIC or Parent BIC indicated in a Settlement Restriction must be valid on the Intended Settlement Date and additionally on the current Business Day if the Intended Settlement Date is in the past.
MVCV255	<ul style="list-style-type: none"> <input type="checkbox"/> Amount field <input type="checkbox"/> Submit button 	The Original Settlement Amount of the Settlement Restriction on cash is not greater than zero.	The Original Settlement Amount stated in a Settlement Restriction on cash must be greater than zero.
MVCV291	<ul style="list-style-type: none"> <input type="checkbox"/> T2S Dedicated Cash Account Number field <input type="checkbox"/> Instructing Party Parent BIC field <input type="checkbox"/> Submit button 	The NCB of the Instructing Party is different than the NCB associated with the T2S Dedicated Cash Account of the Settlement Restriction.	In a Settlement Restriction on cash the NCB of the Instructing Party must be consistent with the NCB of the T2S Party owner of the T2S Dedicated Cash Account stated in the Settlement Restriction.
MVCV292	<ul style="list-style-type: none"> <input type="checkbox"/> T2S Dedicated Cash Account Number field <input type="checkbox"/> Submit button 	The Dedicated Cash Account of a Settlement Restriction is a RTGS Dedicated Transit Account.	The Dedicated Cash Account of a Settlement Restriction on Cash cannot be a RTGS Dedicated Transit Account.

Reference for error message	Field or Button	Error Text	Description
MVDC003	<ul style="list-style-type: none"> <input type="checkbox"/> Actor Reference field <input type="checkbox"/> Instructing Party BIC field <input type="checkbox"/> Instructing Party Parent BIC field <input type="checkbox"/> Submit button 	An unsettled Settlement Restriction exists in T2S for the same T2S Party and the same instruction reference.	The combination of the Instruction Reference and the Instructing Party of a Settlement Restriction must not be the same as any of the non-cancelled and non-revoked unsettled Settlement Restrictions already present in the system.
MVDC005	<ul style="list-style-type: none"> <input type="checkbox"/> Actor Reference field <input type="checkbox"/> Instructing Party BIC field <input type="checkbox"/> Instructing Party Parent BIC field <input type="checkbox"/> Submit button 	A Settlement Restriction that has been settled within a predefined number of days in the past already exists in T2S for the same T2S Party and the same instruction reference.	The combination of the Instruction Reference and the Instructing Party of a Settlement Restriction must not be the same as any Settlement Restriction present in the system that has been settled within a predefined number of days in the past
MVDC007	<ul style="list-style-type: none"> <input type="checkbox"/> Actor Reference field <input type="checkbox"/> Instructing Party BIC field <input type="checkbox"/> Instructing Party Parent BIC field <input type="checkbox"/> Submit button 	A Settlement Restriction that has been cancelled within a predefined number of days in the past already exists in T2S for the same T2S Party and the same instruction reference.	The combination of the Instruction Reference and the Instructing Party of a Settlement Restriction must not be the same as any Settlement Restriction present in the system that has been cancelled within a predefined number of days in the past.
MVDC015	<ul style="list-style-type: none"> <input type="checkbox"/> Actor Reference field 	An unsettled Settlement Instruction exists in T2S for	The combination of the Instruction Reference and the Instructing

Reference for error message	Field or Button	Error Text	Description
	<ul style="list-style-type: none"> <input type="checkbox"/> Instructing Party BIC field <input type="checkbox"/> Instructing Party Parent BIC field <input type="checkbox"/> Submit button 	the same T2S Party and the same instruction reference.	Party of a Settlement Restriction must not be the same as any of the non-cancelled and non-revoked unsettled Settlement Instruction already present in the system.
MVDC017	<ul style="list-style-type: none"> <input type="checkbox"/> Actor Reference field <input type="checkbox"/> Instructing Party BIC field <input type="checkbox"/> Instructing Party Parent BIC field <input type="checkbox"/> Submit button 	A Settlement Instruction that has been settled within a predefined number of days in the past already exists in T2S for the same T2S Party and the same instruction reference.	The combination of the Instruction Reference and the Instructing Party of a Settlement Restriction must not be the same as any Settlement Instruction present in the system that has been settled within a predefined number of days in the past.
MVDC019	<ul style="list-style-type: none"> <input type="checkbox"/> Actor Reference field <input type="checkbox"/> Instructing Party BIC field <input type="checkbox"/> Instructing Party Parent BIC field <input type="checkbox"/> Submit button 	A Settlement Instruction that has been cancelled within a predefined number of days in the past already exists in T2S for the same T2S Party and the same instruction reference.	The combination of the Instruction Reference and the Instructing Party of a Settlement Restriction must not be the same as any Settlement Instruction present in the system that has been cancelled within a predefined number of days in the past.
MVDC022	<ul style="list-style-type: none"> <input type="checkbox"/> Actor Reference field <input type="checkbox"/> Instructing Party BIC field 	A Partially Settled Settlement Instruction exists in T2S for the same T2S	The combination of the Instruction Reference and the Instructing Party of a Settlement Restriction must not be the same as any of the

Reference for error message	Field or Button	Error Text	Description
	<input type="checkbox"/> Instructing Party Parent BIC field <input type="checkbox"/> Submit button	Party and the same instruction reference.	non-cancelled Partially Settled Settlement Instruction already present in the system.
MVDC023	<input type="checkbox"/> Actor Reference field <input type="checkbox"/> Instructing Party field <input type="checkbox"/> Instructing Party Parent BIC field <input type="checkbox"/> Submit button <input type="checkbox"/> Instructing Party BIC field	A Partially Settled Settlement Restriction exists in T2S for the same T2S Party and the same instruction reference.	The combination of the Instruction Reference and the Instructing Party of a Settlement Restriction must not be the same as any of the non-cancelled Partially Settled Settlement Restriction already present in the system.
MVDC025	<input type="checkbox"/> Instructing Party BIC field <input type="checkbox"/> Instructing Party Parent BIC field <input type="checkbox"/> Instructing Party field <input type="checkbox"/> Submit button	The Instructing Party specified in the Settlement Restriction does not exist in T2S Static Data.	The Instructing Party specified in a Settlement Restriction must exist in T2S Static Data.
MVLI805	<input type="checkbox"/> Link Type field <input type="checkbox"/> Submit button	The instruction has a Settlement link indicator 'WITH' and the existing Linked Instruction is already settled.	The Settlement Status of a Settlement Instruction or Settlement Restriction stated as linked instruction with Link Processing Position 'WITH' in a Settlement Restriction must not be 'Settled'.
MVLI806	<input type="checkbox"/> Link Type field <input type="checkbox"/> Submit button	The instruction has a Settlement link indicator 'WITH' and the existing Linked Instruction is already cancelled.	The Cancellation Status of a Settlement Instruction or Settlement Restriction stated as linked instruction with Link Processing Position

Reference for error message	Field or Button	Error Text	Description
			'WITH' in a Settlement Restriction must not be 'Cancelled'.
MVLI807	<ul style="list-style-type: none"><input type="checkbox"/> Link Type field<input type="checkbox"/> Submit button	The instruction has a Settlement link indicator 'BEFORE' and the existing linked Settlement instruction is already settled	The Settlement Status of a Settlement Instruction or Settlement Restriction stated as linked instruction with Link Processing Position 'BEFORE' in a Settlement Restriction must not be 'Settled'.
MVLI819	<ul style="list-style-type: none"><input type="checkbox"/> Intended Settlement Date field<input type="checkbox"/> Link Type field<input type="checkbox"/> Submit button	The instruction has a Settlement link indicator 'WITH' and the Settlement link indicator included in the existing linked instruction is 'BEFORE'.	A Settlement Instruction or Settlement Restriction stated as linked 'WITH' in a Settlement Restriction must not have a previous link 'BEFORE' with the latter instruction, provided that the Intended Settlement Date in both instructions is not identical.
MVLI820	<ul style="list-style-type: none"><input type="checkbox"/> Intended Settlement Date field<input type="checkbox"/> Link Type field<input type="checkbox"/> Submit button	The instruction has a Settlement link indicator 'WITH' and the Settlement link indicator included in the existing linked instruction is 'AFTER'.	A Settlement Instruction or Settlement Restriction stated as linked 'WITH' in a Settlement Restriction must not have a previous link 'AFTER' with the latter instruction, provided that the Intended Settlement Date in both instructions is not identical.

Reference for error message	Field or Button	Error Text	Description
MVLI821	<input type="checkbox"/> Intended Settlement Date field <input type="checkbox"/> Link Type field <input type="checkbox"/> Submit button	The instruction has a Settlement link indicator 'AFTER' and the Settlement link indicator included in the existing linked instruction is 'AFTER'.	A Settlement Instruction or Settlement Restriction stated as linked 'AFTER' in a Settlement Restriction must not have a previous link 'AFTER' with the latter instruction, provided that the Intended Settlement Date in both instructions is not identical.
MVLI822	<input type="checkbox"/> Intended Settlement Date field <input type="checkbox"/> Link Type field <input type="checkbox"/> Submit button	The instruction has a Settlement link indicator 'AFTER' and the Settlement link indicator included in the existing linked instruction is 'WITH'.	A Settlement Instruction or Settlement Restriction stated as linked 'AFTER' in a Settlement Restriction must not have a previous link 'WITH' with the latter instruction, provided that the Intended Settlement Date in both instructions is not identical.
MVLI823	<input type="checkbox"/> Intended Settlement Date field <input type="checkbox"/> Link Type field <input type="checkbox"/> Submit button	The instruction has a Settlement link indicator 'BEFORE' and the Settlement link indicator included in the existing linked instruction is 'BEFORE'.	A Settlement Instruction or Settlement Restriction stated as linked 'BEFORE' in a Settlement Restriction must not have a previous link 'BEFORE' with the latter instruction, provided that the Intended Settlement Date in both instructions is not identical.
MVLI824	<input type="checkbox"/> Intended Settlement Date field	The instruction has a Settlement link indicator 'BE-	A Settlement Instruction or Settlement Restriction stated as linked

Reference for error message	Field or Button	Error Text	Description
	<ul style="list-style-type: none"> <input type="checkbox"/> Link Type field <input type="checkbox"/> Submit button 	FORE' and the Settlement link indicator included in the existing linked instruction is 'WITH'.	'BEFORE' in a Settlement Restriction must not have a previous link 'WITH' with the latter instruction, provided that the Intended Settlement Date in both instructions is not identical.
MVLI834	<ul style="list-style-type: none"> <input type="checkbox"/> Link Type field <input type="checkbox"/> Submit button <input type="checkbox"/> Intended Settlement Date field 	The instruction has a Settlement link indicator 'BEFORE' and the linked instruction's Intended Settlement Date is earlier than the validating instruction's Intended Settlement Date.	The Intended Settlement Date of a Settlement Restriction must be equal to or earlier than the Intended Settlement Date of the Settlement Instruction or Settlement Restriction linked with the first one, if the Link Indicator is 'BEFORE'.
MVLI835	<ul style="list-style-type: none"> <input type="checkbox"/> Intended Settlement Date field <input type="checkbox"/> Link Type field <input type="checkbox"/> Submit button 	The instruction has a Settlement link indicator 'AFTER' and the linked instruction's Intended Settlement Date is later than the validating instruction's Intended Settlement Date.	The Intended Settlement Date of a Settlement Restriction must be equal to or later than the Intended Settlement Date of the Settlement Instruction or Settlement Restriction linked with the first one, if the Link Indicator is 'AFTER'.
MVLI836	<ul style="list-style-type: none"> <input type="checkbox"/> Intended Settlement Date field <input type="checkbox"/> Link Type field <input type="checkbox"/> Pool Instruction Identification field <input type="checkbox"/> Submit button 	The instruction has either a Settlement link indicator 'WITH' or a pool reference and the linked instruction's	The Intended Settlement Date of a Settlement Restriction must be equal to the Intended Settlement Date of the Settlement Instruction or Settlement Restriction linked with the

Reference for error message	Field or Button	Error Text	Description
		Intended Settlement Date is different.	first one, if the Link Indicator is 'WITH' or in case of Pool reference.
MVLI844	<input type="checkbox"/> Pool Instruction Counter field <input type="checkbox"/> Submit button	The number of instructions belonging to a Pool must be the same that the Linked Instruction Counter of the Settlement Instruction or Settlement Restriction	The value of the Pool Instruction Counter stated in a Settlement Restriction must be the same as the value of the Pool Instruction Counter for such a Pool in T2S, if any instruction belonging to that Pool is present in T2S.
MVLI846	<input type="checkbox"/> Pool Instruction Counter field <input type="checkbox"/> Submit button	The instruction exceeds the number of instructions of the pool.	The number of instructions that have already been identified in T2S belonging to the Pool Reference stated in a Settlement Restriction must be lower than the Pool Instruction Counter stated in the Settlement Restriction.
MVLI848	<input type="checkbox"/> Pool Instruction Reference field <input type="checkbox"/> Submit button	The instruction includes more than one Pool Reference or more than one link referring to the same instruction.	A Settlement Restriction must not include more than one Pool Reference or more than one link referring to the same instruction.
MVLI852	<input type="checkbox"/> Link Type field <input type="checkbox"/> Submit button	The instruction has a Settlement link indicator 'WITH' and the existing Linked Instruction is already partially settled.	The Settlement Status of a Settlement Instruction or Settlement Restriction stated as linked instruction with Link Processing Position

Reference for error message	Field or Button	Error Text	Description
			'WITH' in a Settlement Restriction must not be 'Partially Settled'
MVLI855	<input type="checkbox"/> Link Type field <input type="checkbox"/> Submit button	The instruction has a Settlement link indicator 'BEFORE' and the existing Linked Instruction is already partially settled.	The Settlement Status of a Settlement Instruction or Settlement Restriction stated as linked instruction with Link Processing Position 'BEFORE' in a Settlement Restriction must not be 'Partially Settled'
MVLI858	<input type="checkbox"/> Link Type field <input type="checkbox"/> Submit button	The instruction has a Settlement link indicator 'AFTER' and the existing Linked Instruction is already partially settled.	The Settlement Status of a Settlement Instruction or Settlement Restriction stated as linked instruction with Link Processing Position 'AFTER' in a Settlement Restriction must not be 'Partially Settled'
MVLI861	<input type="checkbox"/> Link Type field <input type="checkbox"/> Submit button	The instruction has a Settlement link indicator 'AFTER' and the existing Linked Instruction is already cancelled	The Settlement Status of a Settlement Instruction or Settlement Restriction stated as linked instruction with Link Processing Position 'AFTER' in a Settlement Restriction must not be 'Cancelled'
MVLI864	<input type="checkbox"/> Link Type field <input type="checkbox"/> Submit button	The Linked Instruction is 'Revoked'.	The Approval Status of a Settlement Instruction or Settlement Restriction stated as linked instruction with Link Processing Position 'WITH'

Reference for error message	Field or Button	Error Text	Description
			in a Settlement Restriction must not be 'Revoked'
MVLI866	<input type="checkbox"/> Link Type field <input type="checkbox"/> Submit button	The Linked Instruction is 'Revoked'.	The Approval Status of a Settlement Instruction or Settlement Restriction stated as linked instruction with Link Processing Position 'AFTER' in a Settlement Restriction must not be 'Revoked'
MVLI868	<input type="checkbox"/> Pool Instruction Reference field <input type="checkbox"/> Instructing Party BIC field <input type="checkbox"/> Instructing Party Parent BIC field <input type="checkbox"/> Submit button	A Pool that has been settled within a predefined number of days in the past already exists in T2S for the same T2S Party and the same Pool Identification	The combination of the Pool Identification and the Instructing Party of a Pool must not be the same as any Pool Identification already present in the system that has been settled within a predefined number of days in the past
MVLI869	<input type="checkbox"/> Reference field <input type="checkbox"/> Submit button	The Linked Instruction, referenced by a T2S Instruction Reference, does not exist.	If the reference indicated in the linkage section is the T2S Instruction Reference, then the referenced Settlement Instruction or Settlement Restriction must exist in T2S.
MVLI873	<input type="checkbox"/> Reference field <input type="checkbox"/> Submit button <input type="checkbox"/> Link Type	The Processing Position must be specified.	If a Settlement Restriction specifies a link with another instruction using a T2S Actor Instruction Reference or a T2S

Reference for error message	Field or Button	Error Text	Description
			Instruction Reference, the Processing Position must be specified.
MVLI876	<ul style="list-style-type: none"> <input type="checkbox"/> Link Type field <input type="checkbox"/> Pool Instruction Reference field <input type="checkbox"/> Submit button 	The instruction cannot be linked to a Pool with a Processing Position with AFTER or BEFORE.	If a Settlement Restriction specifies a link to a Pool, if the Processing Position for this link is specified, it only can be WITH.
MVRR901	<ul style="list-style-type: none"> <input type="checkbox"/> Restriction Type – Balance From field <input type="checkbox"/> Submit button 	The Balance From specified in the Settlement Restriction on cash does not exist in T2S.	The Balance From specified in a Settlement Restriction on cash must exist as a Restriction Type in T2S.
MVRR903	<ul style="list-style-type: none"> <input type="checkbox"/> Intended Settlement Date field <input type="checkbox"/> Submit button 	The Balance From specified in the Settlement Restriction on cash is not valid on the Settlement Date.	The Restriction Type specified in the Balance From in a Settlement Restriction on cash must be valid on the Intended Settlement Date and additionally on the current Business Date if the Intended Settlement Date is in the past.
MVRR905	<ul style="list-style-type: none"> <input type="checkbox"/> Restriction Type – Balance From field <input type="checkbox"/> Restriction Type – Balance To field <input type="checkbox"/> Submit button 	The Balance From and Balance To specified in the Settlement Restriction on cash have the same code.	A Settlement Restriction on cash cannot specify the same Balance From and Balance To.
MVRR906	<ul style="list-style-type: none"> <input type="checkbox"/> Restriction Type – Balance From field <input type="checkbox"/> Restriction Type – Balance To field <input type="checkbox"/> Submit button 	The Balance From or Balance To specified in the Settlement Restriction on cash is not deliverable type.	Either the Restriction Type specified in the Balance From or the Restriction Type specified in the Balance To

Reference for error message	Field or Button	Error Text	Description
			in a Settlement Restriction on cash must be 'Deliverable'.
MVRR910	<input type="checkbox"/> Restriction Type – Balance From field <input type="checkbox"/> Restriction Type – Balance To field <input type="checkbox"/> Submit button	The Balance From and Balance To specified in the Settlement Restriction on cash do not apply on cash balance.	The Restriction Types specified in the Balance From and Balance To in a Settlement Restriction on cash must be applicable on cash balance.
MVRR916	<input type="checkbox"/> Restriction Type – Balance To field <input type="checkbox"/> Submit button	The Settlement Restriction on cash sent by a T2S Actor tries to setup or increase a CoSD blocked cash balance.	A Settlement Restriction on cash sent by a T2S Actor cannot set up or increase a CoSD blocked cash balance. (I.e. The Restriction Type specified in the Balance To in a Settlement Restriction on cash cannot be 'CoSD Blocking').
MVRR917	<input type="checkbox"/> Restriction Type – Balance From field <input type="checkbox"/> Submit button	The Settlement Restriction on cash sent by a T2S Actor tries to decrease a CoSD blocked cash balance and the associated CoSD Settlement Instruction is not cancelled	A Settlement Restriction on cash sent by a T2S Actor only can decrease a CoSD blocked cash balance when the related CoSD Settlement Instruction is cancelled.
MVRR918	<input type="checkbox"/> Restriction Reference field <input type="checkbox"/> Submit button	The Restriction Reference specified in the Settlement Restriction on cash does not exist in T2S.	The Restriction Reference specified in a Settlement Restriction on cash must exist in T2S.

Reference for error message	Field or Button	Error Text	Description
MVRR924	<ul style="list-style-type: none"> <input type="checkbox"/> Restriction Type - Balance From field <input type="checkbox"/> Restriction Type - Balance To field <input type="checkbox"/> Restriction Reference field <input type="checkbox"/> Submit button 	The Restriction Type inferred from the Restriction Ref of the Settlement Restriction on cash is different than the Restriction Type of the impacted balance specified in the Settl. Restriction.	If a Settlement Restriction on cash specifies a Restriction Reference, the Restriction Type associated with such Restriction Reference in T2S must be the same than the Restriction Type indicated in the corresponding impacted Balance (Balance From or Balance To) in the Settlement Restriction.
MVRR925	<ul style="list-style-type: none"> <input type="checkbox"/> T2S Dedicated Cash Account Number field <input type="checkbox"/> Restriction Reference field <input type="checkbox"/> Submit button 	The T2S Dedicated Cash Account inferred from the Restriction Ref of the Settl. Restriction on securities is different than the T2S Dedicated Cash Account specified in the Settl. Restriction.	If a Settlement Restriction on cash specifies the Restriction Reference, the T2S Dedicated Cash Account associated with the Restriction Reference must be the same than the T2S Dedicated Cash Account specified in the Settlement Restriction.
MVRR978	<ul style="list-style-type: none"> <input type="checkbox"/> Restriction Reference field <input type="checkbox"/> Submit button 	The Restriction Reference specified in the Settlement Restriction on cash does not apply on cash.	The Restriction Reference specified in a Settlement Restriction on cash must apply on cash.
MVRR989	<ul style="list-style-type: none"> <input type="checkbox"/> Intended Settlement Date field <input type="checkbox"/> Restriction Type – Balance To field <input type="checkbox"/> Submit button 	The Balance To specified in the Settlement Restriction on cash is not valid on the Settlement Date.	The Restriction Type specified in the Balance To in a Settlement Restriction on cash must be valid on the Intended Settlement Date and additionally on the cur-

Reference for error message	Field or Button	Error Text	Description
			rent Business Date if the Intended Settlement Date is in the past.
MVRR992	<input type="checkbox"/> Restriction Type – Balance To field <input type="checkbox"/> Submit button	The Balance To specified in the Settlement Restriction on cash does not exist in T2S.	The Balance To specified in a Settlement Restriction on cash must exist as a Restriction Type in T2S.
MVRR993	<input type="checkbox"/> Restriction Type – Balance From field <input type="checkbox"/> Restriction Type – Balance To field <input type="checkbox"/> Submit button	The Balance From and Balance To in the Settlement Restriction on cash have the same processing type.	The Restriction Type specified in the Balance From and the Restriction Type specified in the Balance To in a Settlement Restriction on cash cannot belong to the same processing type (i.e. if the Balance From is deliverable the Balance to as deliverable type is not allowed).
MVRR994	<input type="checkbox"/> Restriction Type – Balance From field <input type="checkbox"/> Restriction Type – Balance To field <input type="checkbox"/> Restriction Reference field <input type="checkbox"/> Submit button	The Settlement Restriction on cash tries to increase or decrease a blocked, CoSD blocked or reserved cash balance without Restriction reference.	A Settlement Restriction on cash that aims to increase or decrease a blocked, CoSD blocked or reserved cash balance must include a Restriction Reference related to cash. (I.e. If the Restriction Type specified in the Balance From in a Settlement Restriction on cash is 'Blocking', 'CoSD Blocking' or 'Reservation' a Restriction Reference must be specified).

Reference for error message	Field or Button	Error Text	Description
MVSD404	<input type="checkbox"/> Intended Settlement Date field <input type="checkbox"/> Submit button <input type="checkbox"/> Amount field <input type="checkbox"/> Currency field	The Intended Settlement Date of the Settlement Restriction on cash is not a T2S Settlement Date for the Settlement Currency.	The Intended Settlement Date of a Settlement Restriction on cash must be a T2S Settlement Date for the Settlement Currency of the Settlement Restriction.
MVSP212	<input type="checkbox"/> Priority field <input type="checkbox"/> Submit button	'Reserved priority' not allowed for the Instructing Party Type (only NCBs can use it)	'Reserved priority' is allowed in a Settlement Restriction on Cash only if the Instructing Party is a NCB
MVSR705	<input type="checkbox"/> Actor Reference field <input type="checkbox"/> Submit button	Settlement Restriction rejected due to a Restriction Type	A new Settlement Restriction that fulfills a specific restriction configured by its System Entity with positive Restriction Processing Type 'Rejection' is rejected.
MVSR706	<input type="checkbox"/> Submit button		A Settlement Restriction that fulfills a specific restriction configured by its System Entity with negative Restriction Processing Type 'Rejection' is not rejected nor cancelled.
MVSR708	<input type="checkbox"/> Actor Reference field <input type="checkbox"/> Submit button	Settlement Restriction cancelled due to a Restriction Type.	An already existing Settlement Restriction that fulfills a specific restriction configured by its System Entity with positive Restriction Processing Type 'Rejection' is cancelled.

6.5.2.57 Intra-Balance Movements - Search/List Screen

△ [▶ 423]

Reference for error message	Field or Button	Error Text	Description
IIMP079	<input type="checkbox"/> Restriction Type – Balance From <input type="checkbox"/> Restriction Type – Balance To	The cash balance type of Balance-From must be different from the cash balance type of BalanceTo.	The cash balance type of BalanceFrom must be different from the cash balance type of BalanceTo.
QMPC005	<input type="checkbox"/> Amount – from field <input type="checkbox"/> Amount – to field <input type="checkbox"/> Search button	The lower limit of the Cash Amount range is more than the upper limit of the Cash Amount range.	In case the Cash Amount is stated as a range, the lower limit of the Cash Amount range must be less than the upper limit of the Cash Amount range.
QMPC012	<input type="checkbox"/> Intended Settlement Date – from field <input type="checkbox"/> Intended Settlement Date – to field <input type="checkbox"/> Search button	The Intended Settlement Date From is after the Intended Settlement Date To.	In case the Intended Settlement Date is stated as a range, the Intended Settlement Date From must be before the Intended Settlement Date To, i.e. earlier or on the same day as the Intended Settlement Date To.
QMPC013	<input type="checkbox"/> Actual Settlement Date - from field <input type="checkbox"/> Search button	The requested Actual Settlement Date From is older than three calendar months.	The requested Actual Settlement Date From must not be older than three calendar months.
QMPC014	<input type="checkbox"/> Actual Settlement Date - from field <input type="checkbox"/> Actual Settlement Date – to field <input type="checkbox"/> Search button	The Actual Settlement Date From is after the Actual Settlement Date To.	In case the Actual Settlement Date is stated as a range, the Actual Settlement Date From must be before the Actual Settlement Date

Reference for error message	Field or Button	Error Text	Description
			To, i.e. earlier or on the same day as the Actual Settlement Date To.
QMPC015	<input type="checkbox"/> Entry Date Time From field <input type="checkbox"/> Entry Date Time To field <input type="checkbox"/> Search button	The Date From is after the Date To.	In case the Date is stated as a range, the Date From has to be before or equal to the Date To.
QMPC031	<input type="checkbox"/> T2S Dedicated Cash Account Number field <input type="checkbox"/> Search button	The specified T2S Dedicated Cash Account Number is not known in T2S.	In case a T2S Dedicated Cash Account Number is specified, it has to be known in T2S.
QMPC032	<input type="checkbox"/> Instructing Party BIC field <input type="checkbox"/> Account Owner BIC field <input type="checkbox"/> Search button	The specified Party BIC is not known in T2S.	In case a Party BIC is specified, it has to be known in T2S.
QMPC048	<input type="checkbox"/> Instructing Party Parent BIC field <input type="checkbox"/> Search button	The specified Parent BIC is not known in T2S.	In case a Parent BIC is specified, it has to be known in T2S.
QMPC072	<input type="checkbox"/> T2S Dedicated Cash Account Number field <input type="checkbox"/> Account Owner BIC field <input type="checkbox"/> Search button <input type="checkbox"/> Currency field	The specified combination of T2S Dedicated Cash Account Number, Currency, Account Owner and Account Servicer are not consistent.	In case at least two of the following selection criteria are specified, they have to be consistent, i. e. the T2S Dedicated Cash Account is owned by the specified Party <ul style="list-style-type: none"> • T2S Dedicated Cash Account Number • Account Owner • Account Servicer • Currency, in which the T2S Dedicated Cash Account is issued and/

Reference for error message	Field or Button	Error Text	Description
			or in which the Party owns T2SDedicated Cash Accounts.
QMPC073	<input type="checkbox"/> Search Button <input type="checkbox"/> Entry Date and Time – from	The specified Date is in the future.	In case a date from is specified, it must not be in the future.
QMPC084	<input type="checkbox"/> Instructing Party BIC field <input type="checkbox"/> Instructing Party Parent BIC field <input type="checkbox"/> Search button	The specified Parent BIC is not the System Entity of the specified party.	In case the BIC of a party as well as its parent BIC are specified, a party with these two BICs has to be known in T2S.
QMPC095	<input type="checkbox"/> Search Button <input type="checkbox"/> Entry Date and Time - to	The entry date is after the current business date.	In case the Entry Date To is stated, it must not be in the future.

6.5.2.58 Intra-Position Movement - Details Screen

△ [▶ 144]

No references for error messages.

6.5.2.59 Intra-Position Movement - New Screen

△ [▶ 151]

Reference for error message	Field or Button	Error Text	Description
MVCP008	<input type="checkbox"/> Reference field	The Party owner of the instruction/pool which the Settlement Restriction is linked to does not exist in T2S.	In case a Settlement Restriction intends to link to another instruction or pool, the Party owner of the instruction/pool which the instruction is linked to must exist in T2S

Reference for error message	Field or Button	Error Text	Description
MVCP015	<input type="checkbox"/> Submit button	The sender of the Settlement Restriction on Securities is not authorised to send a Settlement Restriction on Securities on the Securities Account.	The sender of a Settlement Restriction on Securities must be authorised to send a Settlement Restriction on Securities on a specific Securities Account.
MVCP016	<input type="checkbox"/> T2S Reference field <input type="checkbox"/> Pool Instruction Identification field <input type="checkbox"/> Reference Owner field <input type="checkbox"/> Reference field <input type="checkbox"/> Submit button <input type="checkbox"/> Link Type field	The sender of the Settlement Restriction on Securities is not authorised to link to an instruction/pool belonging to another party.	In case a Settlement Restriction on Securities intends to link to another instruction or pool, the sender of the Settlement Restriction on Securities must be authorised to link to an instruction/pool belonging to a specific party.
MVCP044	<input type="checkbox"/> Securities Account Number field <input type="checkbox"/> Submit button	The Securities Account informed in the instruction does not exist in T2S.	The Securities Account informed in the instruction must exist in T2S.
MVCP051	<input type="checkbox"/> T2S Reference field <input type="checkbox"/> Reference Owner field	The instruction to which a Settlement Instruction or a Settlement Restriction is to be linked does not exist in T2S.	The instruction to which a Settlement Instruction or a Settlement Restriction is to be linked, if is referenced by a T2S Instruction Reference, must exist in T2S.
MVCP097	<input type="checkbox"/> Instructing Party BIC field <input type="checkbox"/> Restriction type – balance from field <input type="checkbox"/> Submit button	The sender of the Settlement Restriction on Securities is not authorised to unblock a CoSD	The sender of a Settlement Restriction on Securities that tries to unblock a CoSD Securities Blocking must be authorised to send a Settlement Restriction

Reference for error message	Field or Button	Error Text	Description
		Securities Blocking on behalf of the CSD.	on Securities to unblock a CoSD Securities Blocking on behalf of the relevant CSD in T2S (i.e. CSD where the securities are blocked).
MVCP099	<ul style="list-style-type: none"> <input type="checkbox"/> Instructing Party BIC field <input type="checkbox"/> Reference Type field <input type="checkbox"/> Reference field <input type="checkbox"/> Submit button 	The Reference Owner of the Linked Instruction does not belong to the CSD (parent CSD in case of an external CSD) or NCB of the Instructing Party.	If a T2S actor wants to make use of linkages across several instructions sent to T2S via different CSDs or NCBs he holds accounts with, the T2S actor has to make use of the T2S reference.
MVCP120	<ul style="list-style-type: none"> <input type="checkbox"/> Instructing Party BIC field <input type="checkbox"/> Instructing Party Parent BIC field <input type="checkbox"/> Submit button 	The sender of a Settlement Restriction is not authorised to send a Settlement Restriction using this Instructing Party.	If the sender of a Settlement Restriction does not belong to the Instructing Party, then the sender of a Settlement Restriction must be authorised to send a Settlement Restriction using the Instructing Party.
MVCV004	<ul style="list-style-type: none"> <input type="checkbox"/> Securities Account Number field <input type="checkbox"/> Submit button 	The Securities Account of the Settlement Restriction does not exist in T2S.	The Securities Account specified in a Settlement Restriction on securities must exist in T2S.
MVCV110	<ul style="list-style-type: none"> <input type="checkbox"/> Instructing Party BIC field <input type="checkbox"/> Instructing Party Parent BIC field <input type="checkbox"/> Intended settlement date 	The Instructing Party specified in the Settlement Restriction is not	The Instructing Party specified in a Settlement Restriction must be open on the Intended Settlement Date and additionally on the

Reference for error message	Field or Button	Error Text	Description
	<input type="checkbox"/> Submit button	open on the intended settlement date.	current Business Day if the Intended Settlement Date is in the past.
MVCV124	<input type="checkbox"/> Intended settlement date <input type="checkbox"/> Securities Account Number field <input type="checkbox"/> Submit button	The Account Owner derived from the securities account is not open on the settlement date.	The Account Owner derived from the Securities Account of a Settlement Restriction on Securities must be open on the Intended Settlement Date and additionally on the current Business Day if the Intended Settlement Date is in the past.
MVCV206	<input type="checkbox"/> ISIN field <input type="checkbox"/> Submit button	The ISIN code indicated in the Settlement Restriction on securities does not exist in T2S.	The ISIN indicated in a Settlement Restriction on Securities must exist in T2S
MVCV230	<input type="checkbox"/> Instructing Party BIC field <input type="checkbox"/> Instructing Party Parent BIC field <input type="checkbox"/> Intended settlement date <input type="checkbox"/> Submit button	The Instructing Party BIC or Parent BIC specified in the Settlement Restriction is not valid on the intended settlement date.	The Instructing Party BIC or Parent BIC indicated in a Settlement Restriction must be valid on the Intended Settlement Date and additionally on the current Business Day if the Intended Settlement Date is in the past.
MVCV284	<input type="checkbox"/> Intended Settlement Date field <input type="checkbox"/> Securities Account Number field <input type="checkbox"/> Submit button	The Securities Account of the Settlement Restriction is not valid on the intended settlement date.	The Securities Account specified in a Settlement Restriction on securities must be open on the Intended Settlement Date and additionally on the current Busi-

Reference for error message	Field or Button	Error Text	Description
			ness Day if the Intended Settlement Date is in the past.
MVCV285	<input type="checkbox"/> Account owner BIC field <input type="checkbox"/> Securities Account Number field <input type="checkbox"/> Submit button	The Account Owner BIC of the Settlement Restriction on securities is not consistent with the Account Owner derived from the securities account.	The Account Owner BIC specified in a Settlement Restriction on securities must be the Account Owner derived from the Securities Account in T2S Static Data.
MVCV290	<input type="checkbox"/> Securities Account Number field <input type="checkbox"/> Submit button <input type="checkbox"/> Instructing party parent BIC field <input type="checkbox"/> Instructing Party BIC field	The CSD of the Instructing Party is different than the CSD associated with the Securities Account of the Settlement Restriction.	In a Settlement Restriction on securities the CSD of the Instructing Party must be consistent with the CSD of the T2S Party owner of the Securities Account stated in the Settlement Restriction.
MVCV302	<input type="checkbox"/> Intended Settlement Date field <input type="checkbox"/> ISIN field <input type="checkbox"/> Submit button	The ISIN code indicated in the Settlement Restriction on securities is not valid on the intended settlement date.	The ISIN code indicated in a Settlement Restriction on securities must be valid on the Intended Settlement Date and additionally on the current Business Day if the Intended Settlement Date is in the past.
MVCV304	<input type="checkbox"/> Intended Settlement Date field <input type="checkbox"/> ISIN field <input type="checkbox"/> Submit button	The ISIN Code of the Settlement Instruction is not active on the Intended Settlement Date.	The ISIN Code indicated in a Settlement Restriction must be active on the Intended Settlement Date and additionally on the current

Reference for error message	Field or Button	Error Text	Description
			Business Day if the Intended Settlement Date is in the past.
MVCV608	<input type="checkbox"/> Quantity field <input type="checkbox"/> Submit button	The Original Settlement Quantity of the Settlement Restriction on securities is not greater than zero.	The Original Settlement Quantity stated in a Settlement Restriction on securities must be greater than zero.
MVDC003	<input type="checkbox"/> Actor Reference field <input type="checkbox"/> Instructing Party BIC field <input type="checkbox"/> Instructing party parent BIC field <input type="checkbox"/> Submit button	An unsettled Settlement Restriction exists in T2S for the same T2S Party and the same instruction reference.	The combination of the Instruction Reference and the Instructing Party of a Settlement Restriction must not be the same as any of the non-cancelled and non-revoked unsettled Settlement Restrictions already present in the system.
MVDC005	<input type="checkbox"/> Actor Reference field <input type="checkbox"/> Instructing Party BIC field <input type="checkbox"/> Instructing party parent BIC field <input type="checkbox"/> Submit button	A Settlement Restriction that has been settled within a predefined number of days in the past already exists in T2S for the same T2S Party and the same instruction reference.	The combination of the Instruction Reference and the Instructing Party of a Settlement Restriction must not be the same as any Settlement Restriction present in the system that has been settled or partially settled within a predefined number of days in the past.
MVDC007	<input type="checkbox"/> Actor Reference field <input type="checkbox"/> Instructing Party BIC field	A Settlement Restriction that has been cancelled within a predefined number of days in	The combination of the Instruction Reference and the Instructing Party of a Settlement Restriction must not be

Reference for error message	Field or Button	Error Text	Description
	<ul style="list-style-type: none"> <input type="checkbox"/> Instructing party parent BIC field <input type="checkbox"/> Submit button 	the past already exists in T2S for the same T2S Party and the same instruction reference.	the same as any Settlement Restriction present in the system that has been cancelled within a predefined number of days in the past.
MVDC015	<ul style="list-style-type: none"> <input type="checkbox"/> Actor Reference field <input type="checkbox"/> Instructing Party BIC field <input type="checkbox"/> Instructing party parent BIC field <input type="checkbox"/> Submit button 	An unsettled Settlement Instruction exists in T2S for the same T2S Party and the same instruction reference.	The combination of the Instruction Reference and the Instructing Party of a Settlement Restriction must not be the same as any of the non-cancelled and non-revoked unsettled Settlement Instruction already present in the system.
MVDC017	<ul style="list-style-type: none"> <input type="checkbox"/> Actor Reference field <input type="checkbox"/> Instructing Party BIC field <input type="checkbox"/> Instructing party parent BIC field <input type="checkbox"/> Submit button 	A Settlement Instruction that has been settled within a predefined number of days in the past already exists in T2S for the same T2S Party and the same instruction reference.	The combination of the Instruction Reference and the Instructing Party of a Settlement Restriction must not be the same as any Settlement Instruction present in the system that has been settled within a predefined number of days in the past.
MVDC019	<ul style="list-style-type: none"> <input type="checkbox"/> Actor Reference field <input type="checkbox"/> Instructing Party BIC field <input type="checkbox"/> Instructing party parent BIC field <input type="checkbox"/> Submit button 	A Settlement Instruction that has been cancelled within a predefined number of days in the past already exists in T2S for the same T2S	The combination of the Instruction Reference and the Instructing Party of a Settlement Restriction must not be the same as any Settlement Instruction present in the system

Reference for error message	Field or Button	Error Text	Description
		Party and the same instruction reference.	that has been cancelled within a predefined number of days in the past.
MVDC022	<ul style="list-style-type: none"> <input type="checkbox"/> Actor Reference field <input type="checkbox"/> Instructing Party BIC field <input type="checkbox"/> Instructing party parent BIC field <input type="checkbox"/> Submit button 	A Partially Settled Settlement Instruction exists in T2S for the same T2S Party and the same instruction reference.	The combination of the Instruction Reference and the Instructing Party of a Settlement Restriction must not be the same as any of the non-cancelled Partially Settled Settlement Instruction already present in the system.
MVDC023	<ul style="list-style-type: none"> <input type="checkbox"/> Actor Reference field <input type="checkbox"/> Instructing Party BIC field <input type="checkbox"/> Instructing party parent BIC field <input type="checkbox"/> Submit button 	A Partially Settled Settlement Restriction exists in T2S for the same T2S Party and the same instruction reference.	The combination of the Instruction Reference and the Instructing Party of a Settlement Restriction must not be the same as any of the non-cancelled Partially Settled Settlement Restriction already present in the system.
MVDC025	<ul style="list-style-type: none"> <input type="checkbox"/> Instructing Party BIC field <input type="checkbox"/> Instructing party parent BIC field <input type="checkbox"/> Submit button 	The Instructing Party specified in the Settlement Restriction does not exist in T2S Static Data.	The Instructing Party specified in a Settlement Restriction must exist in T2S Static Data.
MVIC306	<ul style="list-style-type: none"> <input type="checkbox"/> Intended Settlement Date field <input type="checkbox"/> ISIN field <input type="checkbox"/> Submit button 	The ISIN Code of the Settlement Restriction is not eligible for settlement in the corresponding CSD.	The ISIN Code of a Settlement Restriction on securities must be eligible for settlement in the corresponding CSD on the Intended Settlement Date and addition-

Reference for error message	Field or Button	Error Text	Description
			ally on the current Business Day if the Intended Settlement Date is in the past.
MVIC310	<ul style="list-style-type: none"> <input type="checkbox"/> Instructing Party BIC field <input type="checkbox"/> Instructing party parent BIC field <input type="checkbox"/> Intended Settlement Date field <input type="checkbox"/> ISIN field <input type="checkbox"/> Submit button 	The Issue Date of the Security is later than the Intended Settlement Date of the Settlement Restriction.	When the Instructing Party is not the technical Issuer CSD or the Issuer CSD of the ISIN Code specified in a Settlement Restriction on Securities, the Intended Settlement Date of a Settlement Restriction on Securities must be equal to or later than the Issue Date of the Security.
MVIC312	<ul style="list-style-type: none"> <input type="checkbox"/> Instructing Party BIC field <input type="checkbox"/> Instructing party parent BIC field <input type="checkbox"/> Intended Settlement Date field <input type="checkbox"/> ISIN field <input type="checkbox"/> Submit button 	The Maturity Date of the Security <u>plus the transformation detection period</u> is equal or earlier than the Intended Settlement Date of the Settlement Restriction.	The Intended Settlement Date of a Settlement Restriction on Securities must be earlier than the Maturity Date of the Security <u>plus the transformation detection period</u> .
MVIC314	<ul style="list-style-type: none"> <input type="checkbox"/> Instructing Party BIC field <input type="checkbox"/> Instructing party parent BIC field <input type="checkbox"/> ISIN field <input type="checkbox"/> Submit button 	The Maturity Date of the Security <u>plus the transformation detection period</u> is earlier or equal than the Current Business Date.	When the Instructing Party is not the investor CSD, the technical Issuer CSD or the Issuer CSD of the ISIN Code specified in a Settlement Restriction on Securities, the Current Business Date must be earlier than the Maturity Date of the ISIN code

Reference for error message	Field or Button	Error Text	Description
			<u>plus the transformation detection period.</u> {CR-757}
MVLI805	<input type="checkbox"/> Link Type field <input type="checkbox"/> Submit button	The instruction has a Settlement link indicator 'WITH' and the existing Linked Instruction is already settled.	The Settlement Status of a Settlement Instruction or Settlement Restriction stated as linked instruction with Link Processing Position 'WITH' in a Settlement Restriction must not be 'Settled'.
MVLI806	<input type="checkbox"/> Link Type field <input type="checkbox"/> Submit button	The instruction has a Settlement link indicator 'WITH' and the existing Linked Instruction is already cancelled.	The Cancellation Status of a Settlement Instruction or Settlement Restriction stated as linked instruction with Link Processing Position 'WITH' in a Settlement Restriction must not be 'Cancelled'.
MVLI807	<input type="checkbox"/> Link Type field <input type="checkbox"/> Submit button	The instruction has a Settlement link indicator 'BEFORE' and the existing linked Settlement instruction is already settled	The Settlement Status of a Settlement Instruction or Settlement Restriction stated as linked instruction with Link Processing Position 'BEFORE' in a Settlement Restriction must not be 'Settled'.
MVLI819	<input type="checkbox"/> Intended Settlement Date field <input type="checkbox"/> Link Type field <input type="checkbox"/> Submit button	The instruction has a Settlement link indicator 'WITH' and the Settlement link indicator in-	A Settlement Instruction or Settlement Restriction stated as linked 'WITH' in a Settlement Restriction must not have a previous link 'BEFORE' with the lat-

Reference for error message	Field or Button	Error Text	Description
		cluded in the existing linked instruction is 'BEFORE'.	ter instruction, provided that the Intended Settlement Date in both instructions is not identical.
MVLI820	<ul style="list-style-type: none"> <input type="checkbox"/> Intended Settlement Date field <input type="checkbox"/> Link Type field <input type="checkbox"/> Submit button 	The instruction has a Settlement link indicator 'WITH' and the Settlement link indicator included in the existing linked instruction is 'AFTER'.	A Settlement Instruction or Settlement Restriction stated as linked 'WITH' in a Settlement Restriction must not have a previous link 'AFTER' with the latter instruction, provided that the Intended Settlement Date in both instructions is not identical.
MVLI821	<ul style="list-style-type: none"> <input type="checkbox"/> Intended Settlement Date field <input type="checkbox"/> Link Type field <input type="checkbox"/> Submit button 	The instruction has a Settlement link indicator 'AFTER' and the Settlement link indicator included in the existing linked instruction is 'AFTER'.	A Settlement Instruction or Settlement Restriction stated as linked 'AFTER' in a Settlement Restriction must not have a previous link 'AFTER' with the latter instruction, provided that the Intended Settlement Date in both instructions is not identical.
MVLI822	<ul style="list-style-type: none"> <input type="checkbox"/> Intended Settlement Date field <input type="checkbox"/> Link Type field <input type="checkbox"/> Submit button 	The instruction has a Settlement link indicator 'AFTER' and the Settlement link indicator included in the existing linked instruction is 'WITH'.	A Settlement Instruction or Settlement Restriction stated as linked 'AFTER' in a Settlement Restriction must not have a previous link 'WITH' with the latter instruction, provided that

Reference for error message	Field or Button	Error Text	Description
			the Intended Settlement Date in both instructions is not identical.
MVLI823	<ul style="list-style-type: none"> <input type="checkbox"/> Intended Settlement Date field <input type="checkbox"/> Link Type field <input type="checkbox"/> Submit button 	The instruction has a Settlement link indicator 'BEFORE' and the Settlement link indicator included in the existing linked instruction is 'BEFORE'.	A Settlement Instruction or Settlement Restriction stated as linked 'BEFORE' in a Settlement Restriction must not have a previous link 'BEFORE' with the latter instruction, provided that the Intended Settlement Date in both instructions is not identical.
MVLI824	<ul style="list-style-type: none"> <input type="checkbox"/> Intended Settlement Date field <input type="checkbox"/> Link Type field <input type="checkbox"/> Submit button 	The instruction has a Settlement link indicator 'BEFORE' and the Settlement link indicator included in the existing linked instruction is 'WITH'.	A Settlement Instruction or Settlement Restriction stated as linked 'BEFORE' in a Settlement Restriction must not have a previous link 'WITH' with the latter instruction, provided that the Intended Settlement Date in both instructions is not identical.
MVLI834	<ul style="list-style-type: none"> <input type="checkbox"/> Intended Settlement Date field <input type="checkbox"/> Link Type field <input type="checkbox"/> Submit button 	The instruction has a Settlement link indicator 'BEFORE' and the linked instruction's Intended Settlement Date is earlier than the validating instruction's Intended Settlement Date.	The Intended Settlement Date of a Settlement Restriction must be equal to or earlier than the Intended Settlement Date of the Settlement Instruction or Settlement Restriction linked with the first one, if the Link Indicator is 'BEFORE'.

Reference for error message	Field or Button	Error Text	Description
MVLI835	<ul style="list-style-type: none"> <input type="checkbox"/> Intended Settlement Date field <input type="checkbox"/> Link Type field <input type="checkbox"/> Submit button 	The instruction has a Settlement link indicator 'AFTER' and the linked instruction's Intended Settlement Date is later than the validating instruction's Intended Settlement Date.	The Intended Settlement Date of a Settlement Restriction must be equal to or later than the Intended Settlement Date of the Settlement Instruction or Settlement Restriction linked with the first one, if the Link Indicator is 'AFTER'.
MVLI836	<ul style="list-style-type: none"> <input type="checkbox"/> Intended Settlement Date field <input type="checkbox"/> Pool Instruction Identification field <input type="checkbox"/> Link Type field <input type="checkbox"/> Submit button 	The instruction has either a Settlement link indicator 'WITH' or a pool reference and the linked instruction's Intended Settlement Date is different.	The Intended Settlement Date of a Settlement Restriction must be equal to the Intended Settlement Date of the Settlement Instruction or Settlement Restriction linked with the first one, if the Link Indicator is 'WITH' or in case of Pool reference.
MVLI844	<ul style="list-style-type: none"> <input type="checkbox"/> Pool Instruction Counter field <input type="checkbox"/> Submit button 	The number of instructions belonging to a Pool must be the same that the Linked Instruction Counter of the Settlement Instruction or Settlement Restriction	The value of the Pool Instruction Counter stated in a Settlement Restriction must be the same as the value of the Pool Instruction Counter for such a Pool in T2S, if any instruction belonging to that Pool is present in T2S.
MVLI846	<ul style="list-style-type: none"> <input type="checkbox"/> Pool Instruction Identification field <input type="checkbox"/> Submit button 	The instruction exceeds the number of instructions of the pool.	The number of instructions that have already been identified in T2S belonging to the Pool Reference stated in a Settlement Restriction

Reference for error message	Field or Button	Error Text	Description
			must be lower than the Pool Instruction Counter stated in the Settlement Restriction.
MVLI848	<input type="checkbox"/> Pool Instruction Identification field <input type="checkbox"/> Submit button	The instruction includes more than one Pool Reference or more than one link referring to the same instruction.	A Settlement Restriction must not include more than one Pool Reference or more than one link referring to the same instruction.
MVLI852	<input type="checkbox"/> Link Type field <input type="checkbox"/> Submit button	The instruction has a Settlement link indicator 'WITH' and the existing Linked Instruction is already partially settled.	The Settlement Status of a Settlement Instruction or Settlement Restriction stated as linked instruction with Link Processing Position 'WITH' in a Settlement Restriction must not be 'Partially Settled'
MVLI855	<input type="checkbox"/> Submit button <input type="checkbox"/> Link Type field	The instruction has a Settlement link indicator 'BEFORE' and the existing Linked Instruction is already partially settled.	The Settlement Status of a Settlement Instruction or Settlement Restriction stated as linked instruction with Link Processing Position 'BEFORE' in a Settlement Restriction must not be 'Partially Settled'.
MVLI858	<input type="checkbox"/> Link Type field <input type="checkbox"/> Submit button	The instruction has a Settlement link indicator 'AFTER' and the existing Linked Instruction is already partially settled.	The Settlement Status of a Settlement Instruction or Settlement Restriction stated as linked instruction with Link Processing Position

Reference for error message	Field or Button	Error Text	Description
			'AFTER' in a Settlement Restriction must not be 'Partially Settled'
MVLI861	<input type="checkbox"/> Link Type field <input type="checkbox"/> Submit button	The instruction has a Settlement link indicator 'AFTER' and the existing Linked Instruction is already cancelled	The Settlement Status of a Settlement Instruction or Settlement Restriction stated as linked instruction with Link Processing Position 'AFTER' in a Settlement Restriction must not be 'Cancelled'
MVLI864	<input type="checkbox"/> Link Type field <input type="checkbox"/> Submit button	The Linked Instruction is 'Revoked'.	The Approval Status of a Settlement Instruction or Settlement Restriction stated as linked instruction with Link Processing Position 'WITH' in a Settlement Restriction must not be 'Revoked'
MVLI866	<input type="checkbox"/> Link Type field <input type="checkbox"/> Submit button	The Linked Instruction is 'Revoked'.	The Approval Status of a Settlement Instruction or Settlement Restriction stated as linked instruction with Link Processing Position 'AFTER' in a Settlement Restriction must not be 'Revoked'
MVLI868	<input type="checkbox"/> Pool Instruction Identification field <input type="checkbox"/> Submit button	A Pool that has been settled within a predefined number of days in the past already exists in T2S for the	The combination of the Pool Identification and the Instructing Party of a Pool must not be the same as any Pool Identification already present in the system

Reference for error message	Field or Button	Error Text	Description
		same T2S Party and the same Pool Identification	that has been settled within a predefined number of days in the past
MVLI869	<ul style="list-style-type: none"> <input type="checkbox"/> T2S Reference field <input type="checkbox"/> Reference field <input type="checkbox"/> Reference Owner field <input type="checkbox"/> Submit button 	The Linked Instruction, referenced by a T2S Instruction Reference, does not exist.	If the Settlement Instruction stated as linked Instruction, is referenced by a T2S Instruction Reference, then the Settlement Instruction must exist in T2S
MVLI873	<ul style="list-style-type: none"> <input type="checkbox"/> Link Type field <input type="checkbox"/> T2S Reference field <input type="checkbox"/> Reference Owner field <input type="checkbox"/> Reference field <input type="checkbox"/> Submit button 	The Processing Position must be specified.	If a Settlement Restriction specifies a link with another instruction using a T2S Actor Instruction Reference or a T2S Instruction Reference , the Processing Position must be specified
MVLI876	<ul style="list-style-type: none"> <input type="checkbox"/> Link Type field <input type="checkbox"/> Pool Instruction Identification field <input type="checkbox"/> Submit button 	The instruction cannot be linked to a Pool with a Processing Position with AFTER or BEFORE.	If a Settlement Restriction specifies a link to a Pool , if the Processing Position for this link is specified, it only can be WITH
MVRR902	<ul style="list-style-type: none"> <input type="checkbox"/> Restriction Type - Balance from field <input type="checkbox"/> Submit button 	The Balance From specified in the Settlement Restriction on securities does not exist in T2S.	The Balance From specified in a Settlement Restriction on securities must exist as a Restriction Type in T2S.
MVRR904	<ul style="list-style-type: none"> <input type="checkbox"/> Intended Settlement Date field <input type="checkbox"/> Restriction Type - Balance from field <input type="checkbox"/> Submit button 	The Balance From specified in the Settlement Restriction on securities is	The Restriction Type specified in the Balance From in a Settlement Restriction on securities must be valid on the In-

Reference for error message	Field or Button	Error Text	Description
		not valid on the Intended Settlement Date.	tended Settlement Date and additionally on the current Business Date if the Intended Settlement Date is in the past.
MVRR907	<input type="checkbox"/> Restriction Type - Balance from field <input type="checkbox"/> Restriction Type - Balance To field <input type="checkbox"/> Submit button	The Balance From or Balance To specified in the Settlement Restriction on securities have the same code.	A Settlement Restriction on securities cannot specify the same Balance From and Balance To.
MVRR908	<input type="checkbox"/> Restriction Type - Balance from field <input type="checkbox"/> Restriction Type - Balance To field <input type="checkbox"/> Submit button	The Balance From or Balance To specified in the Settlement Restriction on securities is not Deliverable type, Earmarking type or Collateralized type.	Either the Restriction Type specified in the Balance From or the Restriction Type specified in the Balance To in a Settlement Restriction on securities must be 'Deliverable', 'Earmarking', 'Earmarking for Auto-Collateralisation' or 'Collateralised'.
MVRR909	<input type="checkbox"/> Restriction Type - Balance from field <input type="checkbox"/> Restriction Type - Balance To field <input type="checkbox"/> Submit button	The Balance From and Balance To specified in the Settlement Restriction on securities do not apply on securities positions.	The Restriction Types specified in the Balance From and Balance To in a Settlement Restriction on securities must be applicable on securities position.
MVRR914	<input type="checkbox"/> Restriction Type - Balance To field <input type="checkbox"/> Submit button	The Settlement Restriction on securities sent by a T2S Actor tries to set up or increase a CoSD blocked position or a Collateralized position	A Settlement Restriction on Securities sent by a T2S Actor cannot set up or increase a CoSD Blocked position or a Collateralized position. (I.e. The Restriction Type specified in

Reference for error message	Field or Button	Error Text	Description
			the Balance To in a Settlement Restriction on Securities cannot be 'CoSD Blocking or 'Collateralized').
MVRR915	<input type="checkbox"/> Restriction Type - Balance from field <input type="checkbox"/> Submit button	The Settlement Restriction on securities sent by a T2S Actor tries to decrease a CoSD blocked position or a Collateralized position.	A Settlement Restriction on Securities sent by a T2S Actor cannot decrease a CoSD Blocked position or Collateralized position. (I.e. The Restriction Type specified in the Balance From in a Settlement Restriction on Securities cannot be 'CoSD Blocking' or 'Collateralised')
MVRR919	<input type="checkbox"/> Restriction Reference field <input type="checkbox"/> Submit button	The Restriction Reference specified in the Settlement Restriction on securities does not exist in T2S.	The Restriction Reference specified in a Settlement Restriction on securities must exist in T2S.
MVRR921	<input type="checkbox"/> Restriction Type - Balance from field <input type="checkbox"/> Restriction Type - Balance To field <input type="checkbox"/> Restriction Reference field <input type="checkbox"/> Submit button	The Restriction Type inferred from the Restriction Ref of the Settlement Restriction on securities is different than the Restriction Type of the impacted balance specified in the Settl. Restriction.	If a Settlement Restriction on securities specifies a Restriction Reference, the Restriction Type associated with such Restriction Reference in T2S must be the same than the Restriction Type indicated in the corresponding impacted Balance (Balance From or Balance To) in the Settlement Restriction.

Reference for error message	Field or Button	Error Text	Description
MVRR922	<ul style="list-style-type: none"> <input type="checkbox"/> Securities Account Number field <input type="checkbox"/> Restriction Reference field <input type="checkbox"/> Submit button 	The securities Account inferred from the Restriction Reference of the Settlement Restriction on securities is different than the securities account specified in the Settlement Restriction.	If a Settlement Restriction on securities specifies the Restriction Reference, the securities account associated with the Restriction Reference must be the same than the securities account specified in the Settlement Restriction.
MVRR923	<ul style="list-style-type: none"> <input type="checkbox"/> ISIN field <input type="checkbox"/> Restriction Reference field <input type="checkbox"/> Submit button 	The security associated inferred from the Restriction Reference of the Settlement Restriction on securities is different than the security specified in the Settlement Restriction.	If a Settlement Restriction on securities specifies the Restriction Reference, the security associated with the Restriction Reference must be the same than the security specified in the Settlement Restriction.
MVRR954	<ul style="list-style-type: none"> <input type="checkbox"/> Restriction Type - Balance from field <input type="checkbox"/> Restriction Reference field <input type="checkbox"/> Submit button 	The Settlement Restriction on securities tries to decrease a blocked, CoSD blocked or reserved securities position without Restriction reference	A Settlement Restriction on securities that aims decrease a blocked, CoSD blocked or reserved securities position must include a Restriction Reference related to securities (I.e. If the Restriction Type specified in the Balance From in a Settlement Restriction on securities is 'Blocking' , 'CoSD blocked or 'Reservation', a Restriction Reference must be specified).

Reference for error message	Field or Button	Error Text	Description
MVRR970	<ul style="list-style-type: none"> <input type="checkbox"/> Restriction Type - Balance from field <input type="checkbox"/> Restriction Type - Balance To field <input type="checkbox"/> Restriction Reference field <input type="checkbox"/> Submit button 	The Restriction Reference is specified and the Settlement Restriction on securities tries to increase or set up an Earmarking or Collateralized position from a deliverable position.	If the Restriction Type specified in the Balance From in a Settlement Restriction on securities is 'Deliverable' and the Restriction Type specified in the Balance To is 'Earmarking' or is 'Earmarking for auto collateralization' or 'Collateralized', the Restriction Reference must not be specified in the Settlement Restriction.
MVRR971	<ul style="list-style-type: none"> <input type="checkbox"/> Restriction Type - Balance from field <input type="checkbox"/> Restriction Type - Balance To field <input type="checkbox"/> Restriction Reference field <input type="checkbox"/> Submit button 	The Restriction Reference is specified and the Settlement Restriction on securities tries to decrease an Earmarking or Collateralized position to a deliverable position.	If the Restriction Type specified in the Balance From in a Settlement Restriction on securities is 'Earmarking' or 'Earmarking for auto collateralization' or 'Collateralized' and the Restriction Type specified in the Balance To is 'Deliverable', the Restriction Reference must not be specified in the Settlement Restriction.
MVRR979	<ul style="list-style-type: none"> <input type="checkbox"/> Restriction Type - Balance from field <input type="checkbox"/> Restriction Type - Balance To field <input type="checkbox"/> Submit button 	The Balance From and Balance To in the Settlement Restriction on securities have the same processing type.	The Restriction Type specified in the Balance From and the Restriction Type specified in the Balance To in a Settlement Restriction on securities cannot belong to the same processing type except for earmarking processing

Reference for error message	Field or Button	Error Text	Description
			type (i.e. if the Balance From is earmarking type the Balance to as earmarking type is allowed).
MVRR980	<ul style="list-style-type: none"> <input type="checkbox"/> Restriction Type - Balance from field <input type="checkbox"/> Restriction Type - Balance To field <input type="checkbox"/> Restriction Reference field <input type="checkbox"/> Submit button 	The Restriction Reference is specified and the Settlement Restriction on securities tries to decrease or increase an Earmarking position.	If the Restriction Type specified in the Balance From in a Settlement Restriction on securities is 'Earmarking' and the Restriction Type specified in the Balance To is 'Earmarking for auto collateralization' or vice versa, the Restriction Reference must not be specified in the Settlement Restriction.
MVRR981	<ul style="list-style-type: none"> <input type="checkbox"/> Restriction Type - Balance from field <input type="checkbox"/> Restriction Type - Balance To field <input type="checkbox"/> Restriction Reference field <input type="checkbox"/> Submit button 	The Restriction Reference is specified and the Settlement Restriction on securities tries to decrease or increase a Collateralized position.	If the Restriction Type specified in the Balance From in a Settlement Restriction on securities is 'Earmarking for auto collateralization' and the Restriction Type specified in the Balance To is 'Collateralized' or vice versa, the Restriction Reference must not be indicated in the Settlement Restriction.
MVRR982	<ul style="list-style-type: none"> <input type="checkbox"/> Restriction Reference field <input type="checkbox"/> Submit button 	The Restriction Reference specified in the Settlement Restriction on securities does not apply on securities.	The Restriction Reference specified in a Settlement Restriction on securities must apply on securities.

Reference for error message	Field or Button	Error Text	Description
MVRR990	<input type="checkbox"/> Restriction Type - Balance To field <input type="checkbox"/> Submit button	The Balance To specified in the Settlement Restriction on securities does not exist in T2S.	The Balance To specified in a Settlement Restriction on securities must exist as a Restriction Type in T2S.
MVRR991	<input type="checkbox"/> Intended Settlement Date field <input type="checkbox"/> Restriction Type - Balance To field <input type="checkbox"/> Submit button	The Balance To specified in the Settlement Restriction on securities is not valid on the Intended Settlement Date.	The Restriction Type specified in the Balance To in a Settlement Restriction on securities must be valid on the Intended Settlement Date and additionally on the current Business Date if the Intended Settlement Date is in the past.
MVRR995	<input type="checkbox"/> Restriction Type - Balance from field <input type="checkbox"/> Submit button	The Settlement Restriction on securities sent by a T2S Actor tries to decrease a CoSD blocked securities position and the associated CoSD Settlement Instruction is not cancelled.	A Settlement Restriction on Securities sent by a T2S Actor only can decrease a CoSD blocked securities position when the related CoSD Settlement Instruction is cancelled.
MVSD402	<input type="checkbox"/> Intended Settlement Date field <input type="checkbox"/> Submit button	The Creation Date is later than the Intended Settlement Date of the Settlement Restriction.	The Creation Date of a Settlement Restriction has to be equal to or earlier than its Intended Settlement Date.
MVSD405	<input type="checkbox"/> Intended Settlement Date field <input type="checkbox"/> Submit button	The Intended Settlement Date of the Settlement Restriction on securities is	The Intended Settlement Date of a Settlement Restriction on securities must be a day

Reference for error message	Field or Button	Error Text	Description
		Saturday, Sunday or a Closing Day in T2S.	from Monday to Friday and a Business Date in T2S
MVSP210	<input type="checkbox"/> Instructing Party BIC field <input type="checkbox"/> Priority field <input type="checkbox"/> Submit button	'Reserved priority' not allowed for the Instructing Party Type (only CSDs can use it)	'Reserved priority' is allowed in a Settlement Restriction on Securities only if the Instructing Party is a CSD
MVSP603	<input type="checkbox"/> ISIN field <input type="checkbox"/> Quantity field <input type="checkbox"/> Submit button	The settlement type stated in the Restriction is not the same as the Type of Settlement specified in T2S Reference Data.	The Settlement Type stated in the Settlement Quantity of a Settlement Restriction on Securities must be the same as the Settlement Type specified in T2S Reference Data for the ISIN Code of the Restriction.
MVSP605	<input type="checkbox"/> ISIN field <input type="checkbox"/> Quantity field <input type="checkbox"/> Submit button	The Settlement Quantity of the Settlement Restriction is lower than the Minimum Settlement Unit	The Settlement Quantity specified in a Settlement Restriction on securities must be equal or greater than the Minimum Settlement Unit specified in T2S.
MVSP607	<input type="checkbox"/> Corporate Action Event Id field <input type="checkbox"/> ISIN field <input type="checkbox"/> Quantity field <input type="checkbox"/> Submit button	The Settlement Quantity of the Settlement Restriction is neither a multiple of Settlement Unit Multiple nor a Deviating Settlement Unit.	The Settlement Quantity of a Settlement Restriction on securities and not related to a 'Corporate Action' must be a multiple of the Settlement Unit Multiple or a Deviating Settlement Unit.
MVSP611	<input type="checkbox"/> Corporate Action Event Id field <input type="checkbox"/> Submit button	The remaining Settlement Quantity of the Settlement Re-	In case of a partially settled Settlement Restriction on Securities

Reference for error message	Field or Button	Error Text	Description
		striction is neither a multiple of Settlement Unit Multiple nor a Deviating Settlement Unit	and not related to a 'Corporate Action', the remaining Settlement Quantity must be a multiple of the Settlement Unit Multiple or a Deviating Settlement Unit.
MVSQ613	<input type="checkbox"/> Quantity <input type="checkbox"/> Settlement Type <input type="checkbox"/> Submit button	The number of decimals of the Settlement Quantity of the Settlement Restriction is greater than the number of decimals of the Settlement Multiple of the related security	The number of decimals of the Settlement Quantity of a Settlement Restriction on Securities must be equal or lower than the number of decimals of the Settlement Unit Multiple of the related Security.
MVSR705	<input type="checkbox"/> Submit button <input type="checkbox"/> Actor reference	Settlement Restriction rejected due to a Restriction Type.	A new Settlement Restriction that fulfills a specific restriction configured by its System Entity with positive Restriction Processing Type 'Rejection' is rejected.
MVSR706	<input type="checkbox"/> Submit button		A Settlement Restriction that fulfills a specific restriction configured by its System Entity with negative Restriction Processing Type 'Rejection' is not rejected nor cancelled.
MVSR708	<input type="checkbox"/> Submit button <input type="checkbox"/> Actor reference	Settlement Restriction cancelled due to a Restriction Type.	An already existing Settlement Restriction that fulfills a specific restriction configured by its

Reference for error message	Field or Button	Error Text	Description
			System Entity with positive Restriction Processing Type 'Rejection' is cancelled.

6.5.2.60 Intra-Position Movements - Search/List Screen

△ [▶ 137]

Reference for error message	Field or Button	Error Text	Description
IIMP102	<input type="checkbox"/> Restriction Type Balance from field <input type="checkbox"/> Restriction Type Balance to field	The securities balance type of BalanceFrom must be different from the securities balance type of BalanceTo.	The securities balance type of BalanceFrom must be different from the securities balance type of BalanceTo.
QMPC006	<input type="checkbox"/> Quantity or nominal securities – from field <input type="checkbox"/> Quantity or nominal securities – to field <input type="checkbox"/> Search button	The lower limit of the Securities Quantity range is greater than the upper limit of the Securities Quantity range.	In case the Securities Quantity is stated as a range, the lower limit of the Securities Quantity range must be less than the upper limit of the Securities Quantity range.
QMPC012	<input type="checkbox"/> Intended Settlement Date – from field <input type="checkbox"/> Intended Settlement Date – to field <input type="checkbox"/> Search button	The Intended Settlement Date From is after the Intended Settlement Date To.	In case the Intended Settlement Date is stated as a range, the Intended Settlement Date From must be before the Intended Settlement Date To, i.e. earlier or on the same day as the Intended Settlement Date To.

Reference for error message	Field or Button	Error Text	Description
QMPC013	<input type="checkbox"/> Actual Settlement Date – from field <input type="checkbox"/> Search button	The requested Actual Settlement Date From is older than 90 business days.	The requested Actual Settlement Date From must not be older than 90 business days.
QMPC014	<input type="checkbox"/> Actual Settlement Date – from field <input type="checkbox"/> Actual Settlement Date – to field <input type="checkbox"/> Search button	The Actual Settlement Date From is after the Actual Settlement Date To.	In case the Actual Settlement Date is stated as a range, the Actual Settlement Date From must be before the Actual Settlement Date To, i.e. earlier or on the same day as the Actual Settlement Date To.
QMPC015	<input type="checkbox"/> Search button <input type="checkbox"/> Entry Date Time – from field <input type="checkbox"/> Entry Date Time – to field	The Date From is after the Date To.	In case the Date is stated as a range, the Date From has to be before or equal to the Date To.
QMPC018	<input type="checkbox"/> ISIN field <input type="checkbox"/> Search button	The specified ISIN is not known in T2S.	In case an ISIN is specified, it has to be known in T2S.
QMPC030	<input type="checkbox"/> Securities Account Number field <input type="checkbox"/> Search button	The specified Securities Account Number is not known in T2S.	In case a Securities Account Number is specified, it has to be known in T2S.
QMPC032	<input type="checkbox"/> Instructing Party BIC field <input type="checkbox"/> Securities Account Owner BIC field <input type="checkbox"/> Search button	The specified Party BIC is not known in T2S.	In case a Party BIC is specified, it has to be known in T2S.
QMPC048	<input type="checkbox"/> Instructing Party Parent BIC field <input type="checkbox"/> Search button	The specified Parent BIC is not known in T2S.	In case a Parent BIC is specified, it has to be known in T2S.

Reference for error message	Field or Button	Error Text	Description
QMPC073	<input type="checkbox"/> Search button <input type="checkbox"/> Entry Date Time – from field	The specified Date is in the future.	In case a date from is specified, it must not be in the future.
QMPC084	<input type="checkbox"/> Instructing Party BIC field <input type="checkbox"/> Instructing Party Parent BIC field <input type="checkbox"/> Search button	The specified Parent BIC is not the System Entity of the specified party.	In case the BIC of a party as well as its parent BIC are specified, a party with these two BICs has to be known in T2S.
QMPC095	<input type="checkbox"/> Search button <input type="checkbox"/> Entry Date Time – to field	The entry date is after the current business date.	In case the Entry Date To is stated, it must not be in the future.

6.5.2.61 Limit Utilisation - Search/List Screen

△ [▶ 349]

Reference for error message	Field or Button	Error Text	Description
QMPC036	<input type="checkbox"/> Identification field <input type="checkbox"/> Search button	The specified Limit Identification is not known in T2S.	In case a Limit Identifier is specified, it has to be known in T2S.
QMPC040	<input type="checkbox"/> Percentage range field <input type="checkbox"/> Search button	The specified lower value for Limit Utilisation is higher than the upper value for Limit Utilisation.	In case both the lower and upper value for Limit Utilisation are specified, the lower value for Limit Utilisation has to be lower than the upper value for Limit Utilisation.

6.5.2.62 Limit Utilisation Journal - Search/List Screen

△ [▶ 353]

Reference for error message	Field or Button	Error Text	Description
QMPC031	<input type="checkbox"/> T2S Dedicated Cash Account Number field <input type="checkbox"/> Search button	The specified T2S Dedicated Cash Account Number is not known in T2S.	In case a T2S Dedicated Cash Account Number is specified, it has to be known in T2S.
QMPC055	<input type="checkbox"/> Date field <input type="checkbox"/> Search button	The specified business date is in the future.	In case a business date is specified, it must not be in the future.

6.5.2.63 Maintenance Cash Instructions – Search/List Screen

△ [▶ 448]

Reference for error message	Field or Button	Error Text	Description
QMPC031	<input type="checkbox"/> Search button <input type="checkbox"/> n/a	The specified T2S Dedicated Cash Account Number is not known in T2S.	In case a T2S Dedicated Cash Account Number is specified, it has to be known in T2S.
QMPC032	<input type="checkbox"/> Instructing Party BIC field <input type="checkbox"/> Search button	The specified Party BIC is not known in T2S.	In case a Party BIC is specified, it has to be known in T2S.
QMPC048	<input type="checkbox"/> Instructing Party Parent BIC field <input type="checkbox"/> Search button	The specified Parent BIC is not known in T2S.	In case a Parent BIC is specified, it has to be known in T2S.
QMPC084	<input type="checkbox"/> Instructing Party BIC field <input type="checkbox"/> Instructing Party Parent BIC field <input type="checkbox"/> Search button	The specified Parent BIC is not the System Entity of the specified party.	In case the BIC of a party as well as its parent BIC are specified, a party with these two BICs has to be known in T2S.
QMPC095	<input type="checkbox"/> n/a	The entry date is after the current business date	In case the Entry Date To is stated, it must not be in the future.

6.5.2.64 Maintenance Securities Instructions - Search/List Screen

△ [▶ 164]

Reference for error message	Field or Button	Error Text	Description
QMPC016	<input type="checkbox"/> Execution Date field <input type="checkbox"/> Search button	The Date From is older than three calendar months.	The Date From must not be older than three calendar months.
QMPC030	<input type="checkbox"/> Securities Account Number field <input type="checkbox"/> Search button	The specified Securities Account Number is not known in T2S.	In case a Securities Account Number is specified, it has to be known in T2S.
QMPC032	<input type="checkbox"/> Instructing Party BIC field <input type="checkbox"/> Search button	The specified Party BIC is not known in T2S.	In case a Party BIC is specified, it has to be known in T2S.
QMPC048	<input type="checkbox"/> Instructing Party Parent BIC field <input type="checkbox"/> Search button	The specified Parent BIC is not known in T2S.	In case a Parent BIC is specified, it has to be known in T2S.
QMPC073	<input type="checkbox"/> Entry Date field <input type="checkbox"/> Execution Date field <input type="checkbox"/> Search button	The specified Date is in the future.	In case a date from is specified, it must not be in the future.
QMPC084	<input type="checkbox"/> Instructing Party BIC field <input type="checkbox"/> Instructing Party Parent BIC field <input type="checkbox"/> Search button	The specified Parent BIC is not the System Entity of the specified party.	In case the BIC of a party as well as its parent BIC are specified, a party with these two BICs has to be known in T2S.

6.5.2.65 Outbound File - Details Screen

△ [▶ 644]

Reference for error message	Field or Button	Error Text	Description
IICR001	<input type="checkbox"/> Party Technical Address field <input type="checkbox"/> Resend button	At least one party technical address does not exist.	Resend communication is only possible for existing party technical addresses.
IICR002	<input type="checkbox"/> Resend button	The T2S System User is not authorized to ask for re-sending of a communication.	A T2S System User must have the appropriate privilege assigned with the requested secured object of type <party> to ask for re-sending a given communication.

6.5.2.66 Outbound Files - Search/List Screen

△ [▶ 641]

Reference for error message	Field or Button	Error Text	Description
IICR001	<input type="checkbox"/> Party Technical Address field <input type="checkbox"/> Resend button	At least one party technical address does not exist.	Resend communication is only possible for existing party technical addresses.
IICR002	<input type="checkbox"/> Resend button	The T2S System User is not authorized to ask for re-sending of a communication.	A T2S System User must have the appropriate privilege assigned with the requested secured object of type <party> to ask for re-sending a given communication.
QMPC015	<input type="checkbox"/> Delivery Date and Time from field <input type="checkbox"/> Delivery Date and Time to field <input type="checkbox"/> Search button	The Date From is after the Date To.	In case the Date is stated as a range, the Date From has to be before or equal to the Date To.

Reference for error message	Field or Button	Error Text	Description
QMPC073	<input type="checkbox"/> Delivery Date and Time from field <input type="checkbox"/> Search button	The specified Date is in the future.	In case a date from is specified, it must not be in the future.

6.5.2.67 Outbound Message - Details Screen

△ [▶ 654]

Reference for error message	Field or Button	Error Text	Description
IICR001	<input type="checkbox"/> Party Technical Address field <input type="checkbox"/> Resend button	At least one party technical address does not exist.	Resend communication is only possible for existing party technical addresses.
IICR002	<input type="checkbox"/> Resend button	The T2S System User is not authorized to ask for re-sending of a communication.	A T2S System User must have the appropriate privilege assigned with the requested secured object of type <party> to ask for re-sending a given communication.

6.5.2.68 Outbound Messages - Search/List Screen

△ [▶ 646]

Reference for error message	Field or Button	Error Text	Description
IICR001	<input type="checkbox"/> Party Technical Address field <input type="checkbox"/> Resend button	At least one party technical address does not exist.	Resend communication is only possible for existing party technical addresses.

Reference for error message	Field or Button	Error Text	Description
IICR002	<input type="checkbox"/> Resend button	The T2S System User is not authorized to ask for re-sending of a communication.	A T2S System User must have the appropriate privilege assigned with the requested secured object of type <party> to ask for re-sending a given communication.
QMPC015	<input type="checkbox"/> Delivery Date and Time from field <input type="checkbox"/> Delivery Date and Time to field <input type="checkbox"/> Delivery Business Date from field <input type="checkbox"/> Delivery Business Date to field <input type="checkbox"/> Search button	The Date From is after the Date To.	In case the Date is stated as a range, the Date From has to be before or equal to the Date To.

6.5.2.69 Outstanding Auto-Collateralisation Credits - Search/List Screen

△ [▶ 393]

Reference for error message	Field or Button	Error Text	Description
QMPC031	<input type="checkbox"/> T2S Dedicated Cash Account Number field <input type="checkbox"/> Search button	The specified T2S Dedicated Cash Account Number is not known in T2S.	In case a T2S Dedicated Cash Account Number is specified, it has to be known in T2S.
QMPC084	<input type="checkbox"/> Party BIC field <input type="checkbox"/> Parent BIC field <input type="checkbox"/> Search button	The specified Parent BIC is not the System Entity of the specified party.	In case the BIC of a party as well as its parent BIC are specified, a party with these two BICs has to be known in T2S.

6.5.2.70 Overall Liquidity - Search/List Screen

△ [▶ 397]

Reference for error message	Field or Button	Error Text	Description
QMPC032	<input type="checkbox"/> Party BIC field <input type="checkbox"/> Search button	The specified Party BIC is not known in T2S.	In case a Party BIC is specified, it has to be known in T2S.
QMPC048	<input type="checkbox"/> Parent BIC field <input type="checkbox"/> Search button	The specified Parent BIC is not known in T2S.	In case a Parent BIC is specified, it has to be known in T2S.
QMPC084	<input type="checkbox"/> Party BIC field <input type="checkbox"/> Parent BIC field <input type="checkbox"/> Search button	The specified Parent BIC is not the System Entity of the specified party.	In case the BIC of a party as well as its parent BIC are specified, a party with these two BICs has to be known in T2S.

6.5.2.71 Penalty - Details Screen

△ [▶ 291]

Reference for error messages	Field or Button	Error Text	Description
PMMO010	<input type="checkbox"/> Re-include	Only failing CSD can request to modify a penalty	Only the Failing CSD can request to modify a Penalty
PMMO016	<input type="checkbox"/> Re-include	The removal, re-inclusion or switch does not refer to the individual penalty identification of the failing party	The removal, re-inclusion or switch must refer to the individual penalty identification of the failing party
PMMO031	<input type="checkbox"/> Re-include	It is not possible to re-include a Penalty that is not removed	The penalty provided in the re-inclusion request must have status Removed

Reference for error messages	Field or Button	Error Text	Description
PMMO032	<input type="checkbox"/> Re-include	It is not possible to re-include a Penalty that was removed because of a Reallocation	The penalty provided in the re-inclusion request cannot be re-included if it has been removed because of a Reallocation

6.5.2.72 Penalty - Re-allocation Screen

△ [▶ 318]

Reference for error messages	Field or Button	Error Text	Description
PMMO008	Submit	The Request Type is 'RALO' and the requestor CSD is not the same as the CSD of the LMFP (CSD of the Instructing Party of the underlying instruction)	The request type is 'RALO' and the requestor CSD is not the same as the CSD of the Instructing Party of the underlying instruction
PMMO021	New Failing Party BIC Submit	The new failing Party is neither the delivering nor the receiving party of the underlying Settlement Instruction that was sent already matched	The new failing Party must be either the delivering or the receiving party of the underlying Settlement Instruction that was sent already matched
PMMO023	New Failing Party BIC Submit	In case the New failing Party BIC corresponds to the delivering party of the underlying Settlement Instruction, the New non-failing	In case the New failing Party BIC corresponds to the delivering party of the underlying Settlement Instruction, the New non-failing

Reference for error messages	Field or Button	Error Text	Description
		Party BIC must correspond to the receiving party, and vice versa	Party BIC must correspond to the receiving party, and vice versa
PMMO025	T2S reference of the Failing Settlement Instruction Submit	The 'T2S reference of the failed Settlement Instruction' is neither the delivering nor the receiving Settlement Instruction created in T2S from the already matched	The 'T2S reference of the failed Settlement Instruction' must be either the delivering or the receiving Settlement Instruction created in T2S
PMMO033	Submit	It is not possible to reallocate a Penalty that is not active	The penalty provided in the reallocation request must have status Active
PMMO034	Submit	It is not possible to reallocate a Penalty that is not a LMFP	The type of the penalty provided in the reallocation request must be LMFP
PMMO035	Submit	It is not possible to reallocate a Penalty already reallocated before	The penalty provided in the reallocation request cannot have been Reallocated before
PMMO037	Submit	The underlying Settlement Instruction of the Penalty was not sent as already matched to T2S	The underlying Settlement Instruction of the penalty provided in the reallocation request must be an instruction sent as already matched to T2S

6.5.2.73 Penalty – Removal Screen

△ [▶ 315]

Reference for error messages	Field or Button	Error Text	Description
PMMO010	<input type="checkbox"/> Submit	Only failing CSD can request to modify a penalty	Only the Failing CSD can request to modify a Penalty
PMMO016	<input type="checkbox"/> Submit	The removal, re-inclusion or switch does not refer to the individual penalty identification of the failing party	The removal, re-inclusion or switch must refer to the individual penalty identification of the failing party
PMMO030	<input type="checkbox"/> Submit	It is not possible to remove a Penalty that is not active	The penalty provided in the removal request must have status Active

6.5.2.74 Penalty - Switch Screen

△ [▶ 322]

Reference for error messages	Field or Button	Error Text	Description
PMMO010	<input type="checkbox"/> Submit	Only failing CSD can request to modify a penalty	Only the Failing CSD can request to modify a Penalty
PMMO016	<input type="checkbox"/> Submit	The removal, re-inclusion or switch does not refer to the individual penalty identification of the failing party	The removal, re-inclusion or switch must refer to the individual penalty identification of the failing party
PMMO036	<input type="checkbox"/> Submit	It is not possible to switch a Penalty that is not active	The penalty provided in the switch request must have status Active

6.5.2.75 Queued Static Data Change – Details Screen



No references for error messages.

6.5.2.76 Queued Static Data Changes – Search/List Screen



No references for error messages.

6.5.2.77 Resend Communication Screen

[▶ 658]

Reference for error message	Field or Button	Error Text	Description
IICR001	<input type="checkbox"/> Party Technical Address field <input type="checkbox"/> Submit button	At least one party technical address does not exist.	Resend communication is only possible for existing party technical addresses.
IICR002	<input type="checkbox"/> Submit button	The T2S System User is not authorized to ask for re-sending of a communication.	A T2S System User must have the appropriate privilege assigned with the requested secured object of type <party> to ask for re-sending a given communication.
IICR003	<input type="checkbox"/> Delivery Date field <input type="checkbox"/> Submit button	The delivery date is no valid business date (current business date or in the past).	The delivery date has to be a valid business date (current business date or in the past).
IICR004	<input type="checkbox"/> Delivery Date field <input type="checkbox"/> Party Technical Address field <input type="checkbox"/> Single Sequence(s) field <input type="checkbox"/> Submit button	At least one sequence number mentioned in the specified selection criteria was not found.	Resend communication on the basis of the message sequence is only possible, if the sequence number exists for the party technical

Reference for error message	Field or Button	Error Text	Description
			address for the possibly mentioned delivery date (business day).
IICR004	<ul style="list-style-type: none"> <input type="checkbox"/> Delivery Date field <input type="checkbox"/> Party Technical Address field <input type="checkbox"/> Single Sequence(s) field <input type="checkbox"/> Submit button 	No communication on the basis of the message sequence found for the specified selection criteria.	Resend communication on the basis of the message sequence is only possible, if the sequence number exists for the party technical address for the possibly mentioned delivery date (business day).
IICR006	<ul style="list-style-type: none"> <input type="checkbox"/> Party Technical Address field <input type="checkbox"/> Delivery Date field <input type="checkbox"/> Sender File Reference field <input type="checkbox"/> Submit button 	No outbound file found for the specified selection criteria.	Resend communication on the basis of the sender file reference is only possible, if the sender file reference exists for the party technical address for the possibly mentioned delivery date (business day).
IICR007	<ul style="list-style-type: none"> <input type="checkbox"/> Party Technical Address field <input type="checkbox"/> Delivery Date field <input type="checkbox"/> Sender Message Reference field <input type="checkbox"/> Submit button 	At least one sender message reference mentioned in the specified selection criteria was not found.	Resend communication on the basis of the sender message reference is only possible, if the sender message reference exists for the party technical address for the possibly mentioned delivery date (business day).
IICR007	<ul style="list-style-type: none"> <input type="checkbox"/> Party Technical Address field <input type="checkbox"/> Delivery Date field <input type="checkbox"/> Sender Message Reference field 	No communication on the basis of the sender message	Resend communication on the basis of the sender message reference is only possible, if the sender message

Reference for error message	Field or Button	Error Text	Description
	<input type="checkbox"/> Submit button	reference found for the specified selection criteria.	reference exists for the party technical address for the possibly mentioned delivery date (business day).

6.5.2.78 Revisions/Audit Trail - List Screen

△ [▶ 662]

No references for error messages.

6.5.2.79 Securities Position - Details Screen

△ [▶ 174]

No references for error messages.

6.5.2.80 Securities Positions - Search/List Screen

△ [▶ 169]

Reference for error message	Field or Button	Error Text	Description
QMPC015	<input type="checkbox"/> Date from field <input type="checkbox"/> Date to field <input type="checkbox"/> Search button	The Date From is after the Date To.	In case the Date is stated as a range, the Date From has to be before or equal to the Date To
QMPC016	<input type="checkbox"/> Date from field <input type="checkbox"/> Search button	The Date From is older than three calendar months.	The Date From must not be older than three calendar months.
QMPC018	<input type="checkbox"/> ISIN field <input type="checkbox"/> Search button	The specified ISIN is not known in T2S.	In case an ISIN is specified, it has to be known in T2S.
QMPC030	<input type="checkbox"/> Search button <input type="checkbox"/> Securities Account Number field	The specified Securities Account Number is not known in T2S.	In case a Securities Account Number is specified, it has to be known in T2S.

Reference for error message	Field or Button	Error Text	Description
QMPC032	<input type="checkbox"/> Party BIC field <input type="checkbox"/> Search button	The specified Party BIC is not known in T2S.	In case a Party BIC is specified, it has to be known in T2S.
QMPC048	<input type="checkbox"/> Parent BIC field <input type="checkbox"/> Search button	The specified Parent BIC is not known in T2S.	In case a Parent BIC is specified, it has to be known in T2S.
QMPC065	<input type="checkbox"/> Parent BIC field <input type="checkbox"/> Party BIC field <input type="checkbox"/> Search button <input type="checkbox"/> Securities Account Number field	The specified combination of selection parameters Securities Account Number, Account Owner and Account Servicer is not consistent.	<p>In case several of the following selection criteria are specified, they have to be consistent, i.e. the securities account is owned by the account owning party and/or operated by the account servicing CSD; the party belongs to the CSD:</p> <ul style="list-style-type: none"> • Securities Account Number • Account Owner • Account Servicer
QMPC091	<input type="checkbox"/> Restriction Type field <input type="checkbox"/> Search button	The specified restriction type is not known in T2S.	In case a restriction type is specified, it has to be known in T2S.

6.5.2.81 Settlement Instruction - Details Screen

△ [▶ 192]

No references for error messages.

6.5.2.82 Settlement Instruction - New Screen

△ [▶ 211]

Reference for error message	Field or Button	Error Text	Description
MVCA105	<input type="checkbox"/> Payment Type Code field <input type="checkbox"/> Externally Matched field <input type="checkbox"/> Currency field <input type="checkbox"/> T2S Dedicated Cash Account field <input type="checkbox"/> Submit button	The Currency of the Settlement Instruction is not the same as the Currency of the debited or credited T2S Dedicated Cash Account.	The Currency of a Settlement Instruction against payment must be the same as the Currency of the debited or credited T2S Dedicated Cash Account (both if it is an already matched Settlement Instruction).
MVCA501	<input type="checkbox"/> T2S Dedicated Cash Account Number field <input type="checkbox"/> Externally Matched field <input type="checkbox"/> Submit button	The Credited T2S Dedicated Cash Account does not exist in T2S.	The Credited T2S Dedicated Cash Account specified in unmatched Settlement Instruction crediting cash must exist in T2S.
MVCA502	<input type="checkbox"/> T2S Dedicated Cash Account Number field <input type="checkbox"/> Externally Matched field <input type="checkbox"/> Submit button	The Debited T2S Dedicated Cash Account does not exist in T2S.	The Debited T2S Dedicated Cash Account specified in unmatched Settlement Instruction debiting cash must exist in T2S.
MVCA503	<input type="checkbox"/> Payment Type Code field <input type="checkbox"/> T2S Dedicated Cash Account Number field <input type="checkbox"/> Externally Matched field <input type="checkbox"/> Submit button	The Credited T2S Dedicated Cash Account does not exist in T2S.	The Credited T2S Dedicated Cash Account and Debited T2S Dedicated Cash Account specified in an already matched Settlement Instruction against payment must exist in T2S.
MVCA505	<input type="checkbox"/> Payment Type Code field	The Credited T2S Dedicated Cash Account is not open on the Settlement Date.	The Credited T2S Dedicated Cash Account in unmatched Settlement Instruction

Reference for error message	Field or Button	Error Text	Description
	<ul style="list-style-type: none"> <input type="checkbox"/> T2S Dedicated Cash Account Number field <input type="checkbox"/> Intended Settlement Date field <input type="checkbox"/> Externally Matched field <input type="checkbox"/> Submit button 		crediting cash must be open on the Intended Settlement Date and additionally on the current Business Day if the Intended Settlement Date is in the past.
MVCA506	<ul style="list-style-type: none"> <input type="checkbox"/> T2S Dedicated Cash Account Number field <input type="checkbox"/> Intended Settlement Date field <input type="checkbox"/> Externally Matched field <input type="checkbox"/> Submit button 	The Debited T2S Dedicated Cash Account in an unmatched Settlement Instruction debiting cash is not open on the ISD and additionally on the current Business Day if the ISD is in the past.	The Debited T2S Dedicated Cash Account in unmatched Settlement Instruction debiting cash must be open on the Intended Settlement Date and additionally on the current Business Day if the Intended Settlement Date is in the past.
MVCA507	<ul style="list-style-type: none"> <input type="checkbox"/> Payment Type Code field <input type="checkbox"/> T2S Dedicated Cash Account Number field <input type="checkbox"/> Intended Settlement Date field <input type="checkbox"/> Externally Matched field <input type="checkbox"/> Submit button 	The Credited T2S Dedicated Cash Account is not open on the Settlement Date.	The Credited T2S Dedicated Cash Account and Debited T2S Dedicated Cash Account in an already matched Settlement Instruction against payment must be open on the Intended Settlement Date and additionally on the current Business Day if the Intended Settlement Date is in the past.
MVCA509	<ul style="list-style-type: none"> <input type="checkbox"/> Securities Account Number field 	The Credited T2S Dedicated Cash Account is not associ-	The Credited T2S Dedicated Cash Account specified in un-

Reference for error message	Field or Button	Error Text	Description
	<ul style="list-style-type: none"> <input type="checkbox"/> Dedicated Cash Account Number field <input type="checkbox"/> Intended Settlement Date field <input type="checkbox"/> Externally Matched field <input type="checkbox"/> Submit button 	ated with the Securities Account on the Settlement Date.	matched Settlement Instruction crediting cash must be associated in T2S with the Securities Account stated in the instruction on the Intended Settlement Date and additionally on the current Business Day if the Intended Settlement Date is in the past.
MVCA510	<ul style="list-style-type: none"> <input type="checkbox"/> Securities Account Number field <input type="checkbox"/> T2S Dedicated Cash Account Number field <input type="checkbox"/> Intended Settlement Date field <input type="checkbox"/> Externally Matched field <input type="checkbox"/> Submit button 	The Debited T2S Dedicated Cash Account is not associated to the Securities Account stated in the Instruction on the Settlement Date.	The Debited T2S Dedicated Cash Account specified in unmatched Settlement Instruction debiting cash must be associated in T2S with the corresponding Securities Account stated in the instruction on the Intended Settlement Date and additionally on the current Business Day if the Intended Settlement Date is in the past.
MVCA511	<ul style="list-style-type: none"> <input type="checkbox"/> Securities Account Number field <input type="checkbox"/> Payment Type Code field <input type="checkbox"/> T2S Dedicated Cash Account Number field 	The Credited T2S Dedicated Cash Account is not associated with the Securities Account on the Settlement Date.	The Credited T2S Dedicated Cash Account and Debited T2S Dedicated Cash Account specified in an already matched Settlement Instruction against payment must be associated with the

Reference for error message	Field or Button	Error Text	Description
	<ul style="list-style-type: none"> <input type="checkbox"/> Intended Settlement Date field <input type="checkbox"/> Externally Matched field <input type="checkbox"/> Submit button 		corresponding Securities Account stated in the instruction on the Intended Settlement Date and additionally on the current Business Day if the Intended Settlement Date is in the past.
MVCA514	<ul style="list-style-type: none"> <input type="checkbox"/> T2S Dedicated Cash Account Number field <input type="checkbox"/> Settlement Amount field <input type="checkbox"/> Externally Matched field <input type="checkbox"/> Submit button 	There is no default Credited T2S Dedicated Cash Account related to the Currency on the Settlement Date.	If the Credited T2S Dedicated Cash Account is not specified in an unmatched Settlement Instruction crediting cash, there has to be in T2S a default Cash Account for the Currency of the cash leg of the Instruction on the Intended Settlement Date and additionally on the current Business Day if the Intended Settlement Date is in the past.
MVCA515	<ul style="list-style-type: none"> <input type="checkbox"/> Dedicated Cash Account Number field <input type="checkbox"/> Settlement Amount field <input type="checkbox"/> Externally Matched field <input type="checkbox"/> Submit button 	There is no default Debited T2S Dedicated Cash Account related to the Currency on the Settlement Date.	If the Debited T2S Dedicated Cash Account is not specified in an unmatched Settlement Instruction debiting cash, there has to be a default Cash Account for the Currency of the cash leg specified in the Instruction on the Intended Settlement Date

Reference for error message	Field or Button	Error Text	Description
			and additionally on the current Business Day if the Intended Settlement Date is in the past.
MVCA516	<ul style="list-style-type: none"> <input type="checkbox"/> Dedicated Cash Account Number field <input type="checkbox"/> Settlement Amount field <input type="checkbox"/> Externally Matched field <input type="checkbox"/> Submit button 	There is no default Credited T2S Dedicated Cash Account related to the Currency on the Settlement Date.	If the Credited T2S Dedicated Cash Account and/or Debited T2S Dedicated Cash Account is/are not specified in an already matched Settlement Instruction against payment, there has to be in T2S a default Cash Account associated with the Currency of the cash leg of the Settlement Instruction on the Intended Settlement Date and additionally on the current Business Day if the Intended Settlement Date is in the past.
MVCA519	<ul style="list-style-type: none"> <input type="checkbox"/> T2S Dedicated Cash Account Number field <input type="checkbox"/> Debit Credit Indication field <input type="checkbox"/> Submit button 	The debited T2S Dedicated Cash account of the Settlement Instruction is under an Insolvency restriction type	The debited T2S Dedicated Cash Account specified in a Settlement Instruction must not have any Insolvency Restriction applicable for the current validation timestamp
MVCP009	<ul style="list-style-type: none"> <input type="checkbox"/> Securities Account Number field <input type="checkbox"/> Submit button 	The sender of the Settlement Instruction is not authorised	The sender of a Settlement Instruction must be authorised to

Reference for error message	Field or Button	Error Text	Description
		to send a Settlement Instruction on the Securities Account.	send a Settlement Instruction on a specific Securities Account.
MVCP010	<input type="checkbox"/> Securities Account Number field <input type="checkbox"/> Externally Matched field <input type="checkbox"/> Submit button	The sender of an Already Matched Settlement Instructions, is not authorised to send a Settlement Instruction on Securities Account of the counterparty.	For Already Matched Settlement Instructions, the sender of a Settlement Instruction must be authorised to send a Settlement Instruction on both the delivering and the receiving Securities Accounts.
MVCP011	<input type="checkbox"/> Receiving Depository BIC field <input type="checkbox"/> Delivery Depository BIC field <input type="checkbox"/> Submit button	The sender of the Settlement Instruction is not authorised to send a Settlement Instruction on behalf of an external CSD.	If the relevant Depository is an external CSD, the sender of a Settlement Instruction must be authorised to send a Settlement Instruction on behalf of that external CSD.
MVCP012	<input type="checkbox"/> Allowed Modification Flag field <input type="checkbox"/> Submit button	The sender of the Settlement Instruction is not authorised to send a Settlement Instruction with the non-modifiable flag activated.	If a Settlement Instruction has the Allowed Modification Flag activated, the sender of the Settlement Instruction must be authorised to send a Settlement Instruction with the non-modifiable flag activated.
MVCP013	<input type="checkbox"/> Link type field <input type="checkbox"/> Submit button	The sender of the Settlement Instruction is not authorised to link to an instruction/pool belonging to another party.	In case a Settlement Instruction intends to link to another instruction or pool, the sender of the Settlement Instruction must

Reference for error message	Field or Button	Error Text	Description
			be authorised to link to an instruction/pool belonging to a specific party.
MVCP036	<input type="checkbox"/> Securities Account Number field <input type="checkbox"/> Party Hold field <input type="checkbox"/> Submit button	The sender of a Settlement Instruction is not authorised to perform a Party Hold on the Securities Account.	The sender of a Settlement Instruction with a Party Hold activated must be authorised to perform a Party Hold on a specific Securities Account.
MVCP037	<input type="checkbox"/> Securities Account Number field <input type="checkbox"/> CSD Hold field <input type="checkbox"/> Submit button	The sender of a Settlement Instruction is not authorised to perform a CSD Hold on a specific Securities Account.	The sender of a Settlement Instruction with a CSD Hold activated must be authorised to perform a CSD Hold on a specific Securities Account.
MVCP038	<input type="checkbox"/> Receiving Depository BIC field <input type="checkbox"/> Delivery Depository BIC field <input type="checkbox"/> CSD Hold field	The sender of a Settlement Instruction is not authorised to perform a CSD Hold on behalf of the parent CSD of the external CSD.	If the relevant Depository is an external CSD, the sender of a Settlement Instruction with a CSD Hold activated must be authorised to send a Settlement Instruction with CSD Hold on behalf of the parent CSD of the external CSD.
MVCP044	<input type="checkbox"/> Securities Account Number field <input type="checkbox"/> Securities Account field	The Securities Account informed in the instruction does not exist in T2S.	The Securities Account informed in the instruction must exist in T2S.

Reference for error message	Field or Button	Error Text	Description
MVCU101	<input type="checkbox"/> Currency field	The Currency of the Settlement Instruction does not exist in T2S.	The Currency of a Settlement Instruction must exist in T2S.
MVCU103	<input type="checkbox"/> Payment Type Code field <input type="checkbox"/> Currency field <input type="checkbox"/> Submit button	The Currency of the Settlement Instruction is not a T2S Settlement Currency.	The Currency of a Settlement Instruction against payment must be a T2S Settlement Currency.
MVCU107	<input type="checkbox"/> Payment Type Code field <input type="checkbox"/> Settlement Amount field <input type="checkbox"/> Currency field <input type="checkbox"/> Submit button	The number of decimals of the Settlement Amount of the Settlement Instruction exceeds the number of decimals defined in T2S for the Currency stated in the Settlement Instruction.	The number of decimals of the Settlement Amount of a Settlement Instruction against payment cannot exceed the number of decimals defined in T2S for the Currency stated in the Settlement Instruction.
MVCV001	<input type="checkbox"/> Securities Account field <input type="checkbox"/> Delivering Depository BIC field <input type="checkbox"/> Submit button	The Delivering Securities Account does not exist in T2S.	If the Delivering depository is an internal CSD, the delivering Securities Account specified in a securities Settlement Instruction must exist in T2S.
MVCV002	<input type="checkbox"/> Receiving Depository BIC field <input type="checkbox"/> Securities Account field <input type="checkbox"/> Submit button	The Receiving Securities Account does not exist in T2S.	If the Receiving depository is an internal CSD, the receiving Securities Account specified in a securities Settlement Instruction must exist in T2S.
MVCV003	<input type="checkbox"/> Externally Matched field <input type="checkbox"/> Securities Account field	The Delivering or Receiving Securities Account does not exist in T2S.	In case of an already matched Settlement Instruction, when the Depository of the

Reference for error message	Field or Button	Error Text	Description
	<input type="checkbox"/> Delivering Depository BIC field <input type="checkbox"/> Receiving Depository BIC field <input type="checkbox"/> Submit button		counterparty is in T2S, the relevant Securities Account must exist in T2S.
MVCV005	<input type="checkbox"/> Receiving CSD Participant Party BIC <input type="checkbox"/> Submit button	The Party BIC of the Receiving CSD Participant is not specified in the Settlement Instruction.	The Party BIC of the Receiving Participant must be present in a receiving already matched cross-CSD settlement instructions
MVCV006	<input type="checkbox"/> Receiving Depository BIC <input type="checkbox"/> Submit button	The Receiving Depository BIC is not specified in the Settlement Instruction.	The Receiving Depository BIC must be present in a receiving already matched cross-CSD settlement instruction
MVCV007	<input type="checkbox"/> Delivering CSD Participant Party BIC <input type="checkbox"/> Submit button	The Party BIC of the Delivering CSD Participant is not specified in the Settlement Instruction.	The Party BIC of the Delivering Participant must be present in a delivering already matched cross-CSD settlement instructions
MVCV008	<input type="checkbox"/> Delivering Depository BIC <input type="checkbox"/> Submit button	The Delivering Depository BIC is not specified in the Settlement Instruction.	The Delivering Depository BIC must be present in a delivering already matched cross-CSD settlement instruction
MVCV106	<input type="checkbox"/> Intended Settlement Date field <input type="checkbox"/> Instructing Party BIC field <input type="checkbox"/> Instructing Party Parent BIC field <input type="checkbox"/> Submit button	The Instructing Party specified in the Settlement Instruction is not open on the settlement date.	The Instructing Party specified in a Settlement Instruction must be open on the Intended Settlement Date and additionally on the current Business Day

Reference for error message	Field or Button	Error Text	Description
			if the Intended Settlement Date is in the past.
MVCV120	<ul style="list-style-type: none"> <input type="checkbox"/> Party BIC field <input type="checkbox"/> Delivering Depository BIC field <input type="checkbox"/> Intended Settlement Date field <input type="checkbox"/> Submit button 	The T2S Delivering Party BIC specified in the Settlement Instruction is not valid on the settlement date.	If the Delivering Depository specified in a Settlement Instruction is an external CSD, the T2S Delivering Party BIC indicated must be valid in T2S BIC Directory on the Intended Settlement Date and additionally on the current Business Day if the Intended Settlement Date is in the past in T2S.
MVCV121	<ul style="list-style-type: none"> <input type="checkbox"/> Party BIC field <input type="checkbox"/> Intended Settlement Date field 	The Client of Delivering CSD Participant BIC specified in the Settlement Instruction is not valid on the settlement date.	The Client of Delivering CSD participant BIC specified in the Settlement Instruction must be valid in T2S BIC Directory on the Intended Settlement Date and additionally on the current Business Day if the Intended Settlement Date is in the past in T2S.
MVCV122	<ul style="list-style-type: none"> <input type="checkbox"/> Party BIC field <input type="checkbox"/> Receiving Depository BIC field <input type="checkbox"/> Submit button 	The T2S Receiving Party BIC specified in the Settlement Instruction is not valid on the settlement date.	If the Receiving Depository specified in a Settlement Instruction is an external CSD, the T2S Receiving Party BIC indicated must be valid in T2S BIC Directory on the Intended Settlement

Reference for error message	Field or Button	Error Text	Description
			Date and additionally on the current Business Day if the Intended Settlement Date is in the past in T2S.
MVCV123	<input type="checkbox"/> Party BIC field <input type="checkbox"/> Intended Settlement Date field <input type="checkbox"/> Submit button	The Client of Receiving CSD Participant BIC specified in the Settlement Instruction is not valid on the settlement date.	The Client of Receiving CSD participant BIC specified in the Settlement Instruction must be valid in T2S BIC Directory on the Intended Settlement Date and additionally on the current Business Day if the Intended Settlement Date is in the past in T2S
MVCV205	<input type="checkbox"/> ISIN field <input type="checkbox"/> Submit button	The ISIN code indicated in the Settlement Instruction does not exist in T2S.	The ISIN code indicated in a Settlement Instruction must exist in T2S
MVCV229	<input type="checkbox"/> Instructing Party BIC field <input type="checkbox"/> Instructing Party Parent BIC field <input type="checkbox"/> Intended Settlement Date field <input type="checkbox"/> Submit button	The Instructing Party BIC or Parent BIC specified in the Settlement Instruction is not valid on the settlement date.	The Instructing Party BIC and Parent BIC indicated in a Settlement Instruction must be valid on the Intended Settlement Date and additionally on the current Business Day if the Intended Settlement Date is in the past.
MVCV234	<input type="checkbox"/> Intended Settlement Date field <input type="checkbox"/> Delivering Depository BIC field	The Delivering Depository specified in the Settlement In-	The Delivering Depository in a Settlement Instruction must be open on the Intended

Reference for error message	Field or Button	Error Text	Description
	<input type="checkbox"/> Submit button	struction is not open on the intended settlement date.	Settlement Date and additionally on the current Business Day if the Intended Settlement Date is in the past.
MVCV235	<input type="checkbox"/> Intended Settlement Date field <input type="checkbox"/> Delivering Depository BIC field <input type="checkbox"/> Submit button	The Delivering Depository BIC in the Settlement Instruction is not valid on the settlement date.	The Delivering Depository BIC in a Settlement Instruction must be valid on the Intended Settlement Date and additionally on the current Business Day if the Intended Settlement Date is in the past.
MVCV236	<input type="checkbox"/> Delivering Depository BIC field <input type="checkbox"/> Submit button	The Delivering Depository specified in the Settlement Instruction is not a CSD or an External CSD	The Delivering Depository specified in a Settlement Instruction must be categorized in T2S as a CSD or as an External CSD.
MVCV237	<input type="checkbox"/> Securities Movement Type Code field <input type="checkbox"/> Delivering Depository BIC field <input type="checkbox"/> Party BIC field <input type="checkbox"/> Submit button	The T2S Delivering Party is not specified in the Settlement Instruction.	If the Delivering Depository specified in a delivering Settlement Instruction is an external CSD, the T2S Delivering Party must be specified in the Settlement Instruction.
MVCV238	<input type="checkbox"/> Delivering Depository BIC field <input type="checkbox"/> Party BIC field <input type="checkbox"/> Submit button	The T2S Delivering Party BIC specified in the Settlement Instruction does not exist in T2S BIC Directory.	If the Delivering Depository specified in a Settlement Instruction is an external CSD, the T2S Delivering

Reference for error message	Field or Button	Error Text	Description
			Party BIC indicated must exist in T2S BIC Directory.
MVCV239	<ul style="list-style-type: none"> <input type="checkbox"/> Delivering Depository BIC field <input type="checkbox"/> Party BIC field <input type="checkbox"/> Submit button 	The T2S Delivering Party does not exist in T2S.	If the Delivering Depository specified in a Settlement Instruction is an internal CSD, the T2S Delivering Party specified must exist in T2S
MVCV241	<ul style="list-style-type: none"> <input type="checkbox"/> Intended Settlement Date field <input type="checkbox"/> Delivering Depository BIC field <input type="checkbox"/> Party BIC field <input type="checkbox"/> Submit button 	The T2S Delivering Party in the Settlement Instruction is not open on the settlement date.	If the Delivering Depository in a Settlement Instruction is an internal CSD, the T2S Delivering Party must be open on the Intended Settlement Date and additionally on the current Business Day if the Intended Settlement Date is in the past.
MVCV242	<ul style="list-style-type: none"> <input type="checkbox"/> Intended Settlement Date field <input type="checkbox"/> Delivering Depository BIC field <input type="checkbox"/> Party BIC field <input type="checkbox"/> Submit button 	The T2S Delivering Party BIC in the Settlement Instruction is not valid on the settlement date.	If the Delivering Depository in a Settlement Instruction is an internal CSD, the T2S Delivering Party BIC must be valid on the Intended Settlement Date and additionally on the current Business Day if the Intended Settlement Date is in the past.

Reference for error message	Field or Button	Error Text	Description
MVCV243	<ul style="list-style-type: none"> <input type="checkbox"/> Securities Movement Type Code field <input type="checkbox"/> Party BIC field <input type="checkbox"/> Delivering Depository BIC field <input type="checkbox"/> Submit button 	The Account Owner BIC and T2S Delivering Party BIC are not consistent.	The Account Owner BIC and the T2S Delivering Party BIC specified in a delivering Settlement Instruction must be the same.
MVCV244	<ul style="list-style-type: none"> <input type="checkbox"/> Party BIC field <input type="checkbox"/> Submit button 	The Client of Delivering CSD Participant BIC specified in the Settlement Instruction does not exist in T2S BIC Directory.	The Client of Delivering CSD participant BIC specified in the Settlement Instruction must exist in T2S BIC Directory.
MVCV245	<ul style="list-style-type: none"> <input type="checkbox"/> Intended Settlement Date field <input type="checkbox"/> Receiving Depository BIC field <input type="checkbox"/> Submit button 	The Receiving Depository in the Settlement Instruction is not open on the settlement date.	The Receiving Depository in a Settlement Instruction must be open on the Intended Settlement Date and additionally on the current Business Day if the Intended Settlement Date is in the past.
MVCV246	<ul style="list-style-type: none"> <input type="checkbox"/> Intended Settlement Date field <input type="checkbox"/> Receiving Depository BIC field <input type="checkbox"/> Submit button 	The Receiving Depository BIC in the Settlement Instruction is not valid on the settlement date.	The Receiving Depository BIC in a Settlement Instruction must be valid on the Intended Settlement Date and additionally on the current Business Day if the Intended Settlement Date is in the past.
MVCV247	<ul style="list-style-type: none"> <input type="checkbox"/> Receiving Depository BIC field <input type="checkbox"/> Submit button 	The Receiving Depository specified in the Settlement In-	The Receiving Depository specified in a Settlement Instruction

Reference for error message	Field or Button	Error Text	Description
		struction is not a CSD or an External CSD	must be categorized in T2S as a CSD or as an External CSD.
MVCV248	<input type="checkbox"/> Securities Movement Type Code field <input type="checkbox"/> Receiving Depository BIC field <input type="checkbox"/> Party BIC field <input type="checkbox"/> Submit button	The T2S Receiving Party is not specified in the Settlement Instruction.	If the Receiving Depository specified in a receiving Settlement Instruction is an external CSD, the T2S Receiving Party must be specified in the Settlement Instruction.
MVCV249	<input type="checkbox"/> Receiving Depository BIC field <input type="checkbox"/> Party BIC field <input type="checkbox"/> Submit button	The T2S Receiving Party BIC specified in the Settlement Instruction does not exist in T2S BIC Directory.	If the Receiving Depository specified in a Settlement Instruction is an external CSD, the T2S Receiving Party BIC indicated in a Settlement Instruction must exist in T2S BIC Directory.
MVCV250	<input type="checkbox"/> Receiving Depository BIC field <input type="checkbox"/> Party BIC field <input type="checkbox"/> Submit button	The T2S Receiving Party does not exist in T2S.	If the Receiving Depository specified in a Settlement Instruction is an internal CSD, the T2S Receiving Party specified must exist in T2S
MVCV251	<input type="checkbox"/> Intended Settlement Date field <input type="checkbox"/> Receiving Depository BIC field <input type="checkbox"/> BIC field <input type="checkbox"/> Securities Account field	The T2S Receiving Party in the Settlement Instruction is not open on the settlement date.	If the Receiving Depository in a Settlement Instruction is an internal CSD, the T2S Receiving Party must be open on the Intended Settlement Date and additionally on the current Business Day

Reference for error message	Field or Button	Error Text	Description
			if the Intended Settlement Date is in the past.
MVCV252	<input type="checkbox"/> Intended Settlement Date field <input type="checkbox"/> Receiving Depository BIC field <input type="checkbox"/> BIC field <input type="checkbox"/> Submit button	The T2S Receiving Party BIC in the Settlement Instruction is not valid on the settlement date.	If the Receiving Depository in a Settlement Instruction is an internal CSD, the T2S Receiving Party BIC must be valid on the Intended Settlement Date and additionally on the current Business Day if the Intended Settlement Date is in the past.
MVCV253	<input type="checkbox"/> Securities Movement Type Code field <input type="checkbox"/> Party BIC field <input type="checkbox"/> Securities Account Owner BIC field <input type="checkbox"/> Submit button	The Account Owner BIC and T2S Receiving Party BIC are not consistent.	The Account Owner BIC and the T2S Receiving Party BIC specified in a receiving Settlement Instruction must be the same.
MVCV254	<input type="checkbox"/> Party BIC field	The Client of Receiving CSD Participant BIC specified in the Settlement Instruction does not exist in T2S BIC Directory.	The Client of Receiving CSD participant BIC specified in the Settlement Instruction must exist in T2S BIC Directory.
MVCV256	<input type="checkbox"/> Debit Credit Indicator field <input type="checkbox"/> T2S Dedicated Cash Account Number field <input type="checkbox"/> Submit button	The Dedicated Cash Account is not consistent with the Debtor Cash Account.	The Dedicated cash account and Debtor cash account must be the same if both are present in Settlement Instruction debiting cash.

Reference for error message	Field or Button	Error Text	Description
MVCV257	<ul style="list-style-type: none"> <input type="checkbox"/> Debit Credit Indicator field <input type="checkbox"/> T2S Dedicated Cash Account Number field <input type="checkbox"/> Submit button 	The Dedicated Cash Account is not consistent with the Creditor Cash Account.	The Dedicated Cash Account and Creditor cash account must be the same if both are present in a Settlement Instruction crediting cash.
MVCV271	<ul style="list-style-type: none"> <input type="checkbox"/> Securities Movement Type Code field <input type="checkbox"/> Securities Account Number field <input type="checkbox"/> Securities Account field <input type="checkbox"/> Submit button 	The Delivering Securities Account is not consistent with the Securities Account of the T2S Delivering Party.	The Delivering Securities Account of a delivering Settlement Instruction must be the same than the Securities Account of the T2S Delivering Party if this latter is present in the Settlement Instruction.
MVCV272	<ul style="list-style-type: none"> <input type="checkbox"/> Securities Movement Type Code field <input type="checkbox"/> Securities Account Number field <input type="checkbox"/> Securities Account field <input type="checkbox"/> Submit button 	The Receiving Securities Account is not consistent with the Securities Account of the T2S Receiving Party.	The Receiving Securities Account of a receiving Settlement Instruction must be the same than the Securities Account of the T2S Receiving Party if this latter is present in the Settlement Instruction.
MVCV273	<ul style="list-style-type: none"> <input type="checkbox"/> Securities Account Number field <input type="checkbox"/> Intended Settlement Date field <input type="checkbox"/> Securities Account field <input type="checkbox"/> Delivering Depository BIC field <input type="checkbox"/> Submit button 	The Delivering Securities Account is not open on the settlement date.	If the Delivering depository is an internal CSD the delivering Securities Account specified in a Settlement Instruction must be open on the Intended Settlement Date and additionally on the current Business Day

Reference for error message	Field or Button	Error Text	Description
			if the Intended Settlement Date is in the past.
MVCV274	<ul style="list-style-type: none"> <input type="checkbox"/> Securities Account Number field <input type="checkbox"/> Securities Account field <input type="checkbox"/> Intended Settlement Date field <input type="checkbox"/> Receiving Depository BIC field <input type="checkbox"/> Submit button 	The Receiving Securities Account is not open on the settlement date.	If the Receiving depository is an internal CSD the receiving Securities Account specified in a Settlement Instruction must be open on the Intended Settlement Date and additionally on the current Business Day if the Intended Settlement Date is in the past.
MVCV275	<ul style="list-style-type: none"> <input type="checkbox"/> Securities Account Number field <input type="checkbox"/> Intended Settlement Date field <input type="checkbox"/> Externally Matched field <input type="checkbox"/> Securities Account field <input type="checkbox"/> Submit button 	The Securities Account of the counterparty in an already matched instruction is not open on the settlement date.	In case of an already matched Settlement Instruction, when the Depository of the counterparty is in T2S, the relevant Securities Account must be open on the Intended Settlement Date and additionally on the current Business Day if the Intended Settlement Date is in the past.
MVCV276	<ul style="list-style-type: none"> <input type="checkbox"/> Securities Account Number field <input type="checkbox"/> Securities Account field <input type="checkbox"/> Delivering Depository BIC field <input type="checkbox"/> Submit button 	The Delivering Depository is not consistent with the depository of the securities account.	If the Delivering Depository specified in a securities Settlement Instruction is internal to T2S, the Delivering Depository must be the same than the depository derived from

Reference for error message	Field or Button	Error Text	Description
			the delivering securities account in T2S Static Data.
MVCV277	<input type="checkbox"/> Securities Account Number field <input type="checkbox"/> Securities Account field <input type="checkbox"/> Receiving Depository BIC field <input type="checkbox"/> Submit button	The Receiving Depository is not consistent with the depository of the securities account.	If the Receiving Depository specified in a securities Settlement Instruction is internal to T2S, the Receiving Depository must be the same than the depository derived from the receiving securities account in T2S Static Data.
MVCV278	<input type="checkbox"/> Securities Account Number field <input type="checkbox"/> Externally Matched field <input type="checkbox"/> Delivering Depository BIC field <input type="checkbox"/> Receiving Depository BIC field <input type="checkbox"/> Submit button	The Depository of the counterparty in an already matched instruction is not consistent with the depository of the corresponding securities account.	In case of an already matched Settlement Instruction, when the Depository of the counterparty is in T2S and it is specified, it must be the same than the depository derived from the relevant securities account in T2S Static Data.
MVCV279	<input type="checkbox"/> Securities Movement Type Code field <input type="checkbox"/> Securities Account Number field <input type="checkbox"/> Delivering Depository BIC field <input type="checkbox"/> Securities Account Owner BIC field <input type="checkbox"/> Submit button	The Account Owner specified is not consistent with the owner of the delivering securities account.	If the Delivering Depository is internal to T2S, the Account Owner BIC derived from the delivering securities account in T2S Static Data must be the same than the Account Owner BIC if it is present in a delivering Settlement Instruction.

Reference for error message	Field or Button	Error Text	Description
MVCV280	<ul style="list-style-type: none"> <input type="checkbox"/> Securities Movement Type Code field <input type="checkbox"/> Securities Account Number field <input type="checkbox"/> Party BIC field <input type="checkbox"/> Securities Account field <input type="checkbox"/> Delivering Depository BIC field <input type="checkbox"/> Submit button 	The T2S Delivering Party specified is not consistent with the owner of the delivering securities account.	If the Delivering Depository is internal to T2S, the Account Owner BIC derived from the delivering securities account in T2S Static Data must be the same than the T2S Delivering Party BIC if it is present in a Settlement Instruction.
MVCV281	<ul style="list-style-type: none"> <input type="checkbox"/> Securities Movement Type Code field <input type="checkbox"/> Securities Account Number field <input type="checkbox"/> Securities Account field <input type="checkbox"/> Receiving Depository BIC field <input type="checkbox"/> Securities Account Owner BIC field <input type="checkbox"/> Submit button 	The Account Owner specified is not consistent with the owner of the receiving securities account.	If the Receiving Depository is internal to T2S, the Account Owner derived from the receiving securities account in T2S Static Data must be the same than the Account Owner if it is present in a receiving Settlement Instruction.
MVCV282	<ul style="list-style-type: none"> <input type="checkbox"/> Securities Movement Type Code field <input type="checkbox"/> Securities Account Number field <input type="checkbox"/> Receiving Depository BIC field 	The T2S Receiving Party specified is not consistent with the owner of the receiving securities account.	If the Receiving Depository is internal to T2S, the Account Owner derived from the receiving securities account in T2S Static Data must be the same than the T2S

Reference for error message	Field or Button	Error Text	Description
	<input type="checkbox"/> Party BIC field <input type="checkbox"/> Securities Account field <input type="checkbox"/> Submit button		Receiving Party if it is present in a Settlement Instruction.
MVCV283	<input type="checkbox"/> Externally Matched field <input type="checkbox"/> Party BIC field <input type="checkbox"/> Delivering Depository BIC field <input type="checkbox"/> Receiving Depository BIC field <input type="checkbox"/> Submit button	The T2S Delivering Party or T2S Receiving Party specified is not consistent with the owner of the corresponding securities account.	In case of an already matched Settlement Instruction, when the Depository of the counterparty is in T2S and it is specified, the Account Owner BIC derived from the counterpart securities account in T2S Static Data must be the same than the counterpart T2S Party BIC.
MVCV286	<input type="checkbox"/> Settlement Quantity field <input type="checkbox"/> Settlement Type field <input type="checkbox"/> Settlement Amount field <input type="checkbox"/> Submit button	The Settlement Amount and Settlement Quantity are zero.	Either the Settlement Amount or Settlement Quantity of a Settlement Instruction must be greater than zero.
MVCV287	<input type="checkbox"/> Securities Movement Type Code field <input type="checkbox"/> Delivering Depository BIC field <input type="checkbox"/> Instructing Party BIC field <input type="checkbox"/> Instructing Party Parent BIC field <input type="checkbox"/> Submit button	The CSD of the Instructing Party is not consistent with the Delivering Depository of the Settlement Instruction.	In a delivering Settlement Instruction the CSD of the Instructing Party must be consistent with the Delivering CSD.

Reference for error message	Field or Button	Error Text	Description
MVCV288	<input type="checkbox"/> Securities Movement Type Code field <input type="checkbox"/> Instructing Party BIC field <input type="checkbox"/> Instructing Party Parent BIC field <input type="checkbox"/> Receiving Depository BIC field <input type="checkbox"/> Submit button	The CSD of the Instructing Party is not consistent with the Receiving Depository of the Settlement Instruction.	In a receiving Settlement Instruction the CSD of the Instructing Party must be consistent with the Receiving CSD.
MVCV289	<input type="checkbox"/> Externally Matched field <input type="checkbox"/> Delivering Depository BIC field <input type="checkbox"/> Instructing Party BIC field <input type="checkbox"/> Instructing Party Parent BIC field <input type="checkbox"/> Receiving Depository BIC field <input type="checkbox"/> Submit button	The CSD of the Instructing Party is not consistent with the Delivering Depository or Receiving Depository of the Settlement Instruction.	In case of an already matched Settlement Instruction, the CSD of the Instructing Party must be consistent with either the Receiving or the Delivering CSD.
MVCV298	<input type="checkbox"/> Delivering Depository BIC field <input type="checkbox"/> ISIN field <input type="checkbox"/> Securities Movement Type Code field <input type="checkbox"/> Submit button	The Security CSD Links does not allow to identify the relevant external CSD for Delivering Depository and ISIN specified in the instruction.	If the Delivering Depository specified in a receiving Settlement Instruction is defined by different parent CSDs as an external CSD, the Security CSD Links must allow to identify the relevant external CSD for the ISIN of the instruction.
MVCV299	<input type="checkbox"/> ISIN field <input type="checkbox"/> Receiving Depository BIC field	The Security CSD Links does not allow to identify the relev-	If the Receiving Depository specified in a delivering Settlement

Reference for error message	Field or Button	Error Text	Description
	<ul style="list-style-type: none"> <input type="checkbox"/> Securities Movement Type Code field <input type="checkbox"/> Submit button 	ant external CSD for the Receiving Depository and ISIN specified in the instruction.	Instruction is defined by different parent CSDs as an external CSD, the Security CSD Links must allow to identify the relevant external CSD for the ISIN of the instruction.
MVCV301	<ul style="list-style-type: none"> <input type="checkbox"/> ISIN field <input type="checkbox"/> Intended Settlement Date field <input type="checkbox"/> Submit button 	The ISIN code indicated in the Settlement Instruction is not valid on the settlement date	The ISIN code indicated in a Settlement Instruction must be valid on the Intended Settlement Date and additionally on the current Business Day if the Intended Settlement Date is in the past.
MVCV303	<ul style="list-style-type: none"> <input type="checkbox"/> ISIN field <input type="checkbox"/> Intended Settlement Date field <input type="checkbox"/> Submit button 	The ISIN Code of the Settlement Instruction is not active on the Settlement Date.	The ISIN Code indicated in a Settlement Instruction must be active on the Intended Settlement Date and additionally on the current Business Day if the Intended Settlement Date is in the past.
MVCV305	<ul style="list-style-type: none"> <input type="checkbox"/> Securities Account Number field <input type="checkbox"/> Securities Account field <input type="checkbox"/> Securities Movement Type Code field <input type="checkbox"/> Submit button 	The delivering securities account of the instruction is under an Insolvency restriction type	The delivering Securities Account specified in delivering securities Settlement Instruction must not have any Insolvency Restriction applicable for the current validation timestamp

Reference for error message	Field or Button	Error Text	Description
MVDC002	<ul style="list-style-type: none"><input type="checkbox"/> Transaction Identification field<input type="checkbox"/> Instructing Party BIC field<input type="checkbox"/> Instructing Party Parent BIC field<input type="checkbox"/> Submit button	An unsettled Settlement Instruction exists in T2S for the same T2S Party and the same instruction reference.	The combination of the Instruction Reference and the Instructing Party of a Settlement Instruction must not be the same as any of the non-cancelled and non-revoked unsettled Settlement Instructions already present in the system.
MVDC004	<ul style="list-style-type: none"><input type="checkbox"/> Transaction Identification field<input type="checkbox"/> Instructing Party BIC field<input type="checkbox"/> Instructing Party Parent BIC field<input type="checkbox"/> Submit button	A Settlement Instruction that has been settled within a predefined number of days in the past already exists in T2S for the same T2S Party and the same instruction reference.	The combination of the Instruction Reference and the Instructing Party of a Settlement Instruction must not be the same as any Settlement Instruction present in the system that has been settled within a predefined number of days in the past.
MVDC006	<ul style="list-style-type: none"><input type="checkbox"/> Transaction Identification field<input type="checkbox"/> Instructing Party BIC field<input type="checkbox"/> Instructing Party Parent BIC field<input type="checkbox"/> Submit button	A Settlement Instruction that has been cancelled within a predefined number of days in the past already exists in T2S for the same T2S Party and the same instruction reference.	The combination of the Instruction Reference and the Instructing Party of a Settlement Instruction must not be the same as any Settlement Instruction present in the system that has been cancelled within a predefined number of days in the past.

Reference for error message	Field or Button	Error Text	Description
MVDC014	<ul style="list-style-type: none"> <input type="checkbox"/> Transaction Identification field <input type="checkbox"/> Instructing Party BIC field <input type="checkbox"/> Instructing Party Parent BIC field <input type="checkbox"/> Submit button 	An unsettled Settlement Restriction exists in T2S for the same T2S Party and the same instruction reference.	The combination of the Instruction Reference and the Instructing Party of a Settlement Instruction must not be the same as any of the non-cancelled and non-revoked unsettled Settlement Restriction already present in the system.
MVDC016	<ul style="list-style-type: none"> <input type="checkbox"/> Transaction Identification field <input type="checkbox"/> Instructing Party BIC field <input type="checkbox"/> Instructing Party Parent BIC field <input type="checkbox"/> Submit button 	A Settlement Restriction that has been settled within a predefined number of days in the past already exists in T2S for the same T2S Party and the same instruction reference.	The combination of the Instruction Reference and the Instructing Party of a Settlement Instruction must not be the same as any Settlement Restriction present in the system that has been settled within a predefined number of days in the past.
MVDC018	<ul style="list-style-type: none"> <input type="checkbox"/> Transaction Identification field <input type="checkbox"/> Instructing Party BIC field <input type="checkbox"/> Instructing Party Parent BIC field <input type="checkbox"/> Submit button 	A Settlement Restriction that has been cancelled within a predefined number of days in the past already exists in T2S for the same T2S Party and the same instruction reference.	The combination of the Instruction Reference and the Instructing Party of a Settlement Instruction must not be the same as any Settlement Restriction present in the system that has been cancelled within a predefined number of days in the past.

Reference for error message	Field or Button	Error Text	Description
MVDC020	<ul style="list-style-type: none"> <input type="checkbox"/> Transaction Identification field 	A Partially Settled Settlement Instruction exists in T2S for the same T2S Party and the same instruction reference.	The combination of the Instruction Reference and the Instructing Party of a Settlement Instruction must not be the same as any of the non-cancelled Partially Settled Settlement Instructions already present in the system.
MVDC021	<ul style="list-style-type: none"> <input type="checkbox"/> Transaction Identification field <input type="checkbox"/> Instructing Party BIC field <input type="checkbox"/> Instructing Party Parent BIC field <input type="checkbox"/> Submit button 	A Partially Settled Settlement Restriction exists in T2S for the same T2S Party and the same instruction reference.	The combination of the Instruction Reference and the Instructing Party of a Settlement Instruction must not be the same as any of the non-cancelled Partially Settled Settlement Restriction already present in the system.
MVDC024	<ul style="list-style-type: none"> <input type="checkbox"/> Instructing Party BIC field <input type="checkbox"/> Instructing Party Parent BIC field <input type="checkbox"/> Submit button 	The Instructing Party specified in the Settlement Instruction does not exist in T2S Static Data.	The Instructing Party specified in a Settlement Instruction must exist in T2S Static Data.
MVIC305	<ul style="list-style-type: none"> <input type="checkbox"/> ISIN field <input type="checkbox"/> Intended Settlement Date field <input type="checkbox"/> Receiving Depository BIC field <input type="checkbox"/> Delivering Depository BIC field <input type="checkbox"/> Submit button 	The ISIN Code of the Settlement Instruction is not eligible for settlement in the delivering CSD.	The ISIN Code of a delivering Settlement Instruction must be eligible for settlement in the delivering CSD on the Intended Settlement Date and additionally on the current

Reference for error message	Field or Button	Error Text	Description
			Business Day if the Intended Settlement Date is in the past.
MVIC307	<input type="checkbox"/> ISIN field <input type="checkbox"/> Receiving Depository BIC field <input type="checkbox"/> Delivering Depository BIC field <input type="checkbox"/> Intended Settlement Date field <input type="checkbox"/> Submit button	The CSD of the T2S Party does not allow settlement with the counterpart for the ISIN Code on the ISD and additionally on the current Business Day if the ISD is in the past.	The CSD of the T2S Party of a Settlement Instruction must allow settlement with the CSD of the counterpart for the ISIN Code (either per security or per issuer CSD or per issue country) on the Intended Settlement Date and additionally on the current Business Day if the Intended Settlement Date is in the past.
MVIC308	<input type="checkbox"/> ISIN field <input type="checkbox"/> Receiving Depository BIC field <input type="checkbox"/> Delivering Depository BIC field <input type="checkbox"/> Intended Settlement Date field <input type="checkbox"/> Submit button	The CSD of the counterpart does not allow settlement with the CSD of the T2S Party for the ISIN Code on the ISD and additionally on the current Business Day if the ISD is in the past.	The CSD of the counterpart of a Settlement Instruction must allow settlement with the CSD of the T2S Party for the ISIN Code (either per security or per issuer CSD or per issue country) on the Intended Settlement Date and additionally on the current Business Day if the Intended Settlement Date is in the past.
MVIC309	<input type="checkbox"/> Intended Settlement Date field <input type="checkbox"/> Instructing Party BIC field	The Issue Date of the Security is later than the Intended	When the Instructing Party is not the technical Issuer CSD or the Issuer CSD of the ISIN Code specified in

Reference for error message	Field or Button	Error Text	Description
	<ul style="list-style-type: none"> <input type="checkbox"/> Instructing Party Parent BIC field <input type="checkbox"/> Submit button 	Settlement Date of the Settlement Instruction.	a Settlement Instruction, the Intended Settlement Date of a Settlement Instruction must be equal to or later than the Issue Date of the Security.
MVIC311	<ul style="list-style-type: none"> <input type="checkbox"/> ISIN field <input type="checkbox"/> Intended Settlement Date field <input type="checkbox"/> Submit button 	The Maturity Date of the Security plus the transformation detection period is earlier or equal than the Intended Settlement Date of the Settlement Instruction.	When the Instructing Party is not the investor CSD, the technical Issuer CSD or the Issuer CSD of the ISIN Code specified in a Settlement Instruction, the Intended Settlement Date of a Settlement Instruction must be earlier than the Maturity Date of the Security plus the transformation detection period.
MVIC313	<ul style="list-style-type: none"> <input type="checkbox"/> ISIN field <input type="checkbox"/> Instructing Party BIC field <input type="checkbox"/> Instructing Party Parent BIC field <input type="checkbox"/> Submit button 	The Maturity Date of the Security plus the transformation detection period is earlier or equal than the Current Business Date.	When the Instructing Party is not the investor CSD, the technical Issuer CSD or the Issuer CSD of the ISIN Code specified in a Settlement Instruction, the Current Business Date must be earlier than the Maturity Date of the ISIN code plus the transformation detection period.

Reference for error message	Field or Button	Error Text	Description
MVLI801	<input type="checkbox"/> Link Type field <input type="checkbox"/> Submit button	The instruction has a Settlement link indicator 'WITH' and the existing Linked Instruction is already settled.	The Settlement Status of a Settlement Instruction or Settlement Restriction stated as linked instruction with Link Processing Position 'WITH' in a Settlement Instruction must not be 'Settled'.
MVLI802	<input type="checkbox"/> Link Type field <input type="checkbox"/> Submit button	The instruction has a Settlement link indicator 'WITH' and the existing Linked Instruction is already cancelled.	The Cancellation Status of a Settlement Instruction or Settlement Restriction stated as linked instruction with Link Processing Position 'WITH' in a Settlement Instruction must not be 'Cancelled'.
MVLI803	<input type="checkbox"/> Link Type field <input type="checkbox"/> Submit button	The instruction has a Settlement link indicator 'BEFORE' and the existing linked Settlement instruction is already settled	The Settlement Status of a Settlement Instruction or Settlement Restriction stated as linked instruction with Link Processing Position 'BEFORE' in a Settlement Instruction must not be 'Settled'.
MVLI813	<input type="checkbox"/> Intended Settlement Date field <input type="checkbox"/> Link Type field <input type="checkbox"/> Submit button	The instruction has a Settlement link indicator 'WITH' and the Settlement link indicator included in the existing linked instruction is 'BEFORE'.	If a Settlement Instruction states a link 'WITH' with a Settlement Instruction or a Settlement Restriction, these latter must not have a previous link 'BEFORE' with the Settlement Instruction

Reference for error message	Field or Button	Error Text	Description
			unless they have the same Intended Settlement Date.
MVLI814	<ul style="list-style-type: none"><input type="checkbox"/> Intended Settlement Date field<input type="checkbox"/> Link Type field<input type="checkbox"/> Submit button	The instruction has a Settlement link indicator 'WITH' and the Settlement link indicator included in the existing linked instruction is 'AFTER'.	A Settlement Instruction or Settlement Restriction stated as linked 'WITH' in a Settlement Instruction must not have a previous link 'AFTER' with the latter instruction, provided that the Intended Settlement Date in both instructions is not identical.
MVLI815	<ul style="list-style-type: none"><input type="checkbox"/> Intended Settlement Date field<input type="checkbox"/> Link Type field<input type="checkbox"/> Submit button	The instruction has a Settlement link indicator 'AFTER' and the Settlement link indicator included in the existing linked instruction is 'AFTER'.	A Settlement Instruction or Settlement Restriction stated as linked 'AFTER' in a Settlement Instruction must not have a previous link 'AFTER' with the latter instruction, provided that the Intended Settlement Date in both instructions is not identical.
MVLI816	<ul style="list-style-type: none"><input type="checkbox"/> Intended Settlement Date field<input type="checkbox"/> Link Type field<input type="checkbox"/> Submit button	The instruction has a Settlement link indicator 'AFTER' and the Settlement link indicator included in the existing linked instruction is 'WITH'.	A Settlement Instruction or Settlement Restriction stated as linked 'AFTER' in a Settlement Instruction must not have a previous link 'WITH' with the latter instruction, provided that the In-

Reference for error message	Field or Button	Error Text	Description
			tended Settlement Date in both instructions is not identical.
MVLI817	<ul style="list-style-type: none"> <input type="checkbox"/> Intended Settlement Date field <input type="checkbox"/> Link Type field <input type="checkbox"/> Submit button 	The instruction has a Settlement link indicator 'BEFORE' and the Settlement link indicator included in the existing linked instruction is 'BEFORE'.	A Settlement Instruction or Settlement Restriction stated as linked 'BEFORE' in a Settlement Instruction must not have a previous link 'BEFORE' with the latter instruction, provided that the Intended Settlement Date in both instructions is not identical.
MVLI818	<ul style="list-style-type: none"> <input type="checkbox"/> Intended Settlement Date field <input type="checkbox"/> Link Type field <input type="checkbox"/> Submit button 	The instruction has a Settlement link indicator 'BEFORE' and the Settlement link indicator included in the existing linked instruction is 'WITH'.	A Settlement Instruction or Settlement Restriction stated as linked 'BEFORE' in a Settlement Instruction must not have a previous link 'WITH' with the latter instruction, provided that the Intended Settlement Date in both instructions is not identical.
MVLI831	<ul style="list-style-type: none"> <input type="checkbox"/> Intended Settlement Date field <input type="checkbox"/> Link Type field <input type="checkbox"/> Submit button 	The instruction has a Settlement link indicator 'BEFORE' and the linked instruction's Intended Settlement Date is earlier than the validating instruction's Intended Settlement Date.	The Intended Settlement Date of a Settlement Instruction must be equal to or earlier than the Intended Settlement Date of the Settlement Instruction or Settlement Restriction linked with the first one, if the Link Indicator is 'BEFORE'.

Reference for error message	Field or Button	Error Text	Description
MVLI832	<ul style="list-style-type: none"> <input type="checkbox"/> Intended Settlement Date field <input type="checkbox"/> Link Type field <input type="checkbox"/> Submit button 	The instruction has a Settlement link indicator 'AFTER' and the linked instruction's Intended Settlement Date is later than the validating instruction's Intended Settlement Date.	The Intended Settlement Date of a Settlement Instruction must be equal to or later than the Intended Settlement Date of the Settlement Instruction or Settlement Restriction linked with the first one, if the Link Indicator is 'AFTER'.
MVLI833	<ul style="list-style-type: none"> <input type="checkbox"/> Intended Settlement Date field <input type="checkbox"/> Link Type field <input type="checkbox"/> Pool Instruction Reference field <input type="checkbox"/> Submit button 	The instruction has either a Settlement link indicator 'WITH' or a pool reference and the linked instruction's Intended Settlement Date is different.	The Intended Settlement Date of a Settlement Instruction must be equal to the Intended Settlement Date of the Settlement Instruction or Settlement Restriction linked with the first one, if the Link Indicator is 'WITH' or in case of Pool reference.
MVLI843	<ul style="list-style-type: none"> <input type="checkbox"/> Pool Instruction Counter field <input type="checkbox"/> Submit button 	The number of instructions belonging to a Pool must be the same that the Linked Instruction Counter of the Settlement Instruction or Settlement Restriction	The value of the Pool Instruction Counter stated in a Settlement Instruction, must be the same as the value of the Pool Instruction Counter for such a Pool in T2S, if any instruction belonging to that Pool is already present in T2S.
MVLI845	<ul style="list-style-type: none"> <input type="checkbox"/> Pool Instruction Counter field <input type="checkbox"/> Submit button 	The instruction exceeds the number of instructions of the pool.	The number of instructions that have already been identified in T2S as belonging to the

Reference for error message	Field or Button	Error Text	Description
			Pool Reference stated in a Settlement Instruction must be lower than the Pool Instruction Counter stated in that Settlement Instruction
MVLI847	<input type="checkbox"/> Pool Instruction Reference field <input type="checkbox"/> Submit button	The instruction includes more than one Pool Reference or more than one link referring to the same instruction.	A Settlement Instruction must not include more than one Pool Reference or more than one link referring to the same instruction.
MVLI851	<input type="checkbox"/> Link Type field <input type="checkbox"/> Submit button	The instruction has a Settlement link indicator 'WITH' and the existing Linked Instruction is already partially settled.	The Settlement Status of a Settlement Instruction or Settlement Restriction stated as linked instruction with Link Processing Position 'WITH' in a Settlement Instruction must not be 'Partially Settled'
MVLI854	<input type="checkbox"/> Link Type field <input type="checkbox"/> Submit button	The instruction has a Settlement link indicator 'BEFORE' and the existing Linked Instruction is already partially settled.	The Settlement Status of a Settlement Instruction or Settlement Restriction stated as linked instruction with Link Processing Position 'BEFORE' in a Settlement Instruction must not be 'Partially Settled'
MVLI857	<input type="checkbox"/> Link Type field <input type="checkbox"/> Submit button	The instruction has a Settlement link indicator 'AFTER' and the	The Settlement Status of a Settlement Instruction or Settlement

Reference for error message	Field or Button	Error Text	Description
		existing Linked Instruction is already partially settled.	Restriction stated as linked instruction with Link Processing Position 'AFTER' in a Settlement Instruction must not be 'Partially Settled'
MVLI860	<input type="checkbox"/> Link Type field <input type="checkbox"/> Submit button	The instruction has a Settlement link indicator 'AFTER' and the existing Linked Instruction is already cancelled	The Settlement Status of a Settlement Instruction or Settlement Restriction stated as linked instruction with Link Processing Position 'AFTER' in a Settlement Instruction must not be 'Cancelled'
MVLI863	<input type="checkbox"/> Link Type field <input type="checkbox"/> Submit button	The Linked Instruction is 'Revoked'.	The Approval Status of a Settlement Instruction or Settlement Restriction stated as linked instruction with Link Processing Position 'WITH' in a Settlement Instruction must not be 'Revoked'
MVLI865	<input type="checkbox"/> Link Type field <input type="checkbox"/> Submit button	The Linked Instruction is 'Revoked'.	The Approval Status of a Settlement Instruction or Settlement Restriction stated as linked instruction with Link Processing Position 'AFTER' in a Settlement Instruction must not be 'Revoked'

Reference for error message	Field or Button	Error Text	Description
MVLI868	<input type="checkbox"/> Pool Instruction Reference field <input type="checkbox"/> Instructing Party BIC field <input type="checkbox"/> Instructing Party Parent BIC field <input type="checkbox"/> Submit button	A Pool that has been settled within a pre-defined number of days in the past already exists in T2S for the same T2S Party and the same Pool Identification	The combination of the Pool Identification and the Instructing Party of a Pool must not be the same as any Pool Identification already present in the system that has been settled within a pre-defined number of days in the past
MVRR926	<input type="checkbox"/> Cash Sub Balance Type <input type="checkbox"/> Submit button	The Cash Sub Balance Type specified in the Settlement Instruction is not Deliverable Type.	The Restriction Type specified in the Cash Sub Balance Type in a Settlement Instruction can only be 'Deliverable'.
MVRR929	<input type="checkbox"/> Securities Movement Type Code field <input type="checkbox"/> Receiving Securities Sub Balance Type <input type="checkbox"/> Submit button	If a Settlement Instruction specifies the Receiving Securities Sub Balance Type, it cannot be a blocking or reservation securities position.	If the Receiving Securities Sub Balance Type is specified in a Settlement Instruction, it must not be a restriction type of Blocking or Reservation
MVRR934	<input type="checkbox"/> Restriction Reference field <input type="checkbox"/> Submit button	The Restriction Reference specified in the Settlement Restriction does not apply on blocked or reserved securities position	The Restriction Reference specified in a Settlement Instruction for the use of a restricted securities position must be related to a Blocked or Reserved securities position.

Reference for error message	Field or Button	Error Text	Description
MVRR935	<ul style="list-style-type: none"> <input type="checkbox"/> Restriction Reference field <input type="checkbox"/> Submit button 	The Restriction Reference specified in the Settlement Instruction does not exist in T2S.	The Restriction Reference specified in a Settlement Instruction for the use of a restricted cash balance must exist in T2S.
MVRR936	<ul style="list-style-type: none"> <input type="checkbox"/> Restriction Reference field <input type="checkbox"/> Submit button 	The Restriction Reference specified in the Settlement Instruction is not related to a Blocked or Reserved cash balance.	The Restriction Reference specified in a Settlement Instruction for the use of a restricted cash balance must be related to a Blocked or Reserved cash balance.
MVRR937	<ul style="list-style-type: none"> <input type="checkbox"/> Delivering Securities Sub Balance Type <input type="checkbox"/> Restriction Reference field <input type="checkbox"/> Submit button 	A Restriction Reference related to securities is not specified in the Settlement Instruction which makes use of a Blocked or Reserved position.	If a Settlement Instruction makes use thru direct debit of a Blocked or Reserved restricted position, a Restriction Reference related to securities must be specified. (I.e. If the Restriction Type specified in the Delivering Securities Sub Balance Type in a Settlement Instruction is 'Blocking' or 'Reservation' a Restriction Reference must be specified).
MVRR941	<ul style="list-style-type: none"> <input type="checkbox"/> Securities Movement Type Code field <input type="checkbox"/> Restriction Reference field 	The Settlement Instruction is Free of Payment and makes use of a restricted cash balance.	A Settlement Instruction Free of Payment cannot make use of a restricted cash balance.

Reference for error message	Field or Button	Error Text	Description
	<ul style="list-style-type: none"> <input type="checkbox"/> Cash Sub Balance Type field <input type="checkbox"/> Payment Type Code field <input type="checkbox"/> Submit button 		
MVRR942	<ul style="list-style-type: none"> <input type="checkbox"/> Securities Movement Type Code field <input type="checkbox"/> Delivering Securities Sub Balance Type <input type="checkbox"/> Restriction Reference field <input type="checkbox"/> Submit button 	The Free of Delivering Settlement Instruction tries to make use of a restricted securities position.	A Free of Delivery Settlement Instruction cannot make use of a restricted securities position (i.e. A Free of Delivery Settlement Instruction cannot specify a Restriction Reference neither a Restriction type related to securities).
MVRR944	<ul style="list-style-type: none"> <input type="checkbox"/> Securities Account Number field <input type="checkbox"/> Restriction Reference field <input type="checkbox"/> Submit button 	The delivering securities account of the Settlement Instruction is different than the securities account inferred from the Restriction Reference	If a Settlement Instruction makes use of a restricted position specifying the Restriction Reference, the securities account associated with the Restriction Reference must be the same than the securities account specified in the Settlement Instruction.
MVRR945	<ul style="list-style-type: none"> <input type="checkbox"/> Restriction Reference field <input type="checkbox"/> ISIN field <input type="checkbox"/> Submit button 	The security of the Settlement Instruction is different than the security inferred from the Restriction Reference.	If a Settlement Instruction makes use of a restricted position specifying the Restriction Reference, the security associated with the Restriction Reference must be the same

Reference for error message	Field or Button	Error Text	Description
			than the security specified in the Settlement Instruction.
MVRR947	<ul style="list-style-type: none"> <input type="checkbox"/> T2S Dedicated Cash Account Number field <input type="checkbox"/> Restriction Reference field <input type="checkbox"/> Submit button 	The T2S dedicated cash account specified or default cash account of the Settlement Instruction is different than the cash account inferred from the Restriction Reference.	If a Settlement Instruction makes use of a restricted cash balance specifying the Restriction Reference, the T2S Dedicated Cash Account associated with the Restriction Reference must be the same than the T2S dedicated Cash Account specified in the Settlement Instruction or the default T2S dedicated Cash Account if not present in the Settlement Instruction.
MVRR948	<ul style="list-style-type: none"> <input type="checkbox"/> Delivering Securities Sub Balance Type <input type="checkbox"/> Receiving Securities Sub Balance Type <input type="checkbox"/> Submit button 	A Settlement Instruction cannot make use of a CoSD Blocking or Collateralized position.	A Settlement Instruction cannot make use of CoSD blocking or Collateralized positions. (I.e. The Restriction Type specified in either the Delivering or the Receiving Securities Sub Balance Type in a Settlement Instruction cannot be 'CoSD blocking' or 'Collateralized')

Reference for error message	Field or Button	Error Text	Description
MVRR951	<ul style="list-style-type: none"> <input type="checkbox"/> Restriction Reference field <input type="checkbox"/> Submit button 	The Restriction Reference related to cash is specified in a crediting cash Settlement Instruction	If a Settlement Instruction specifies a Restriction Reference related to cash, the Settlement Instruction must be debiting cash.
MVRR957	<ul style="list-style-type: none"> <input type="checkbox"/> Intended Settlement Date field <input type="checkbox"/> Cash Sub Balance Type <input type="checkbox"/> Submit button 	The Cash Sub Balance Type specified in the Settlement Instruction is not valid on the Settlement Date.	The Restriction Type specified in the Cash Sub Balance Type in a Settlement Instruction must be valid on the Intended Settlement Date or on the current Business Date if the Intended Settlement Date is in the past.
MVRR958	<ul style="list-style-type: none"> <input type="checkbox"/> Cash Sub Balance Type <input type="checkbox"/> Submit button 	The Cash Sub Balance Type specified in the Settlement Instruction does not apply on cash balance.	The Restriction Type specified in the Cash Sub Balance Type in a Settlement Instruction must be applicable on cash balance in T2S.
MVRR959	<ul style="list-style-type: none"> <input type="checkbox"/> Delivering Securities Sub Balance Type <input type="checkbox"/> Submit button 	The Delivering Securities Sub Balance Type specified in the Settlement Instruction does not exist in T2S.	If the Delivering Securities Sub Balance Type is specified in a Settlement Instruction, it must exist as a Restriction Type in T2S.
MVRR960	<ul style="list-style-type: none"> <input type="checkbox"/> Intended Settlement Date field <input type="checkbox"/> Delivering Securities Sub Balance Type <input type="checkbox"/> Submit button 	The Delivering Securities Sub Balance Type specified in the Settlement Instruction is not valid on the Settlement Date.	The Restriction Type specified in the Delivering Securities Sub Balance Type in a Settlement Instruction must be valid on the Intended Settlement Date and additionally on the current Busi-

Reference for error message	Field or Button	Error Text	Description
			ness Date if the Intended Settlement Date is in the past.
MVRR961	<ul style="list-style-type: none"> <input type="checkbox"/> Delivering Securities Sub Balance Type <input type="checkbox"/> Submit button 	The Delivering Securities Sub Balance Type specified in the Settlement Instruction does not apply on securities position.	The Restriction Type specified in the Delivering Securities Sub Balance Type in a Settlement Instruction must be applicable on securities position in T2S.
MVRR962	<ul style="list-style-type: none"> <input type="checkbox"/> Receiving Securities Sub Balance Type <input type="checkbox"/> Submit button 	The Receiving Securities Sub Balance Type specified in the Settlement Instruction does not exist in T2S.	If the Receiving Securities Sub Balance Type is specified in a Settlement Instruction, it must exist as a Restriction Type in T2S.
MVRR963	<ul style="list-style-type: none"> <input type="checkbox"/> Delivering Securities Sub Balance Type <input type="checkbox"/> Restriction Reference field <input type="checkbox"/> Submit button 	The Restriction Reference specified in the Settlement Instruction does not apply on blocked securities position.	If a Settlement Instruction makes use thru direct debit of a Blocked restricted position, the Restriction Reference specified must be related to a blocked securities position in T2S. (I.e. If the Restriction Type specified in the Delivering Securities Sub Balance Type in a Settlement Instruction is 'Blocking', a Restriction Reference must be related to a blocked securities position in T2S).

Reference for error message	Field or Button	Error Text	Description
MVRR964	<ul style="list-style-type: none"><input type="checkbox"/> Delivering Securities Sub Balance Type<input type="checkbox"/> Restriction Reference field<input type="checkbox"/> Submit button	The Restriction Reference specified in the Settlement Instruction does not apply on reserved securities position.	If a Settlement Instruction makes use thru direct debit of a Reserved restricted position, the Restriction Reference specified must be related to reserved securities position in T2S. (I.e. If the Restriction Type specified in the Delivering Securities Sub Balance Type in a Settlement Instruction is 'Reservation', a Restriction Reference must be related to a reserved securities position in T2S).
MVRR965	<ul style="list-style-type: none"><input type="checkbox"/> Receiving Securities Sub Balance Type<input type="checkbox"/> Submit button	The Receiving Securities Sub Balance Type specified in the Settlement Instruction does not apply on securities position.	The Restriction Type specified in the Receiving Securities Sub Balance Type in a Settlement Instruction must be applicable on securities position in T2S.
MVRR972	<ul style="list-style-type: none"><input type="checkbox"/> Receiving Securities Sub Balance Type<input type="checkbox"/> Submit button	The Receiving Securities Sub Balance Type specified in the Settlement Instruction is not valid on the Settlement Date.	The Restriction Type specified in the Receiving Securities Sub Balance Type in a Settlement Instruction must be valid on the Intended Settlement Date and additionally on the current Busi-

Reference for error message	Field or Button	Error Text	Description
			ness Date if the Intended Settlement Date is in the past.
MVRR984	<ul style="list-style-type: none"> <input type="checkbox"/> Receiving Securities Sub Balance Type <input type="checkbox"/> Restriction Reference field <input type="checkbox"/> Submit button 	The Restriction Reference related to securities is specified in the receiving securities Settlement Instruction.	A receiving securities Settlement Instruction can set up or increase an 'Earmarking' or 'Earmarking for auto collateralization securities position', therefore the Restriction Reference must not be specified in the Settlement Instruction.
MVRR986	<ul style="list-style-type: none"> <input type="checkbox"/> Delivering Securities Sub Balance Type <input type="checkbox"/> Restriction Reference field <input type="checkbox"/> Submit button 	The Restriction Type associated to the Restriction Reference is different than the Restriction Type of the Settlement Instruction.	If a Settlement Instruction makes use thru direct debit of a Blocked restricted position, the Restriction Type associated with the Restriction Reference must be the same than the Delivering Securities Sub Balance specify in the Settlement Instruction.
MVRR987	<ul style="list-style-type: none"> <input type="checkbox"/> Delivering Securities Sub Balance Type <input type="checkbox"/> Restriction Reference field <input type="checkbox"/> Submit button 	The Restriction Type associated with the Restriction Reference is different than the Restriction Type of the Settlement Instruction.	If a Settlement Instruction makes use thru direct debit of a Reserved restricted position, the Restriction Type associated with the Restriction Reference must be the same than the Delivering Securities Sub Balance specify in the Settlement Instruction.

Reference for error message	Field or Button	Error Text	Description
MVRR988	<input type="checkbox"/> Cash Sub Balance Type field	The Cash Sub Balance Type specified in the Settlement Instruction does not exist in T2S.	If the Cash Sub Balance Type is specified in a Settlement Instruction, it must exist as a Restriction Type in T2S.
MVSD401	<input type="checkbox"/> Intended Settlement Date field <input type="checkbox"/> Trade Date field <input type="checkbox"/> Submit button	The Trade Date is later than the Intended Settlement Date of the Settlement Instruction.	The Trade Date of a Settlement Instruction has to be equal to or earlier than its Intended Settlement Date.
MVSD403	<input type="checkbox"/> Payment Type Code field <input type="checkbox"/> Settlement Amount field <input type="checkbox"/> Intended Settlement Date field <input type="checkbox"/> Submit button	The Intended Settlement Date of the Settlement Instruction against payment is not a T2S Settlement Date for the Settlement Currency.	The Intended Settlement Date of a Settlement Instruction against payment must be a T2S Settlement Date for the Settlement Currency of the Settlement Instruction.
MVSD406	<input type="checkbox"/> Payment Type Code field <input type="checkbox"/> Intended Settlement Date field <input type="checkbox"/> Submit button	The Intended Settlement Date of the Settlement Instruction free of payment is Saturday, Sunday or a Closing Day in T2S.	The Intended Settlement Date of a Settlement Instruction free of payment must be a day from Monday to Friday and a Business Date in T2S
MVSD411	<input type="checkbox"/> Intended Settlement Date field <input type="checkbox"/> Submit button	The Intended Settlement Date of the instruction exceeds the predefined time frame for past-dated instructions	If the Intended Settlement Date of an instruction is a date in the past, the Intended Settlement Date must not exceed the predefined time frame for past-dated instructions.

Reference for error message	Field or Button	Error Text	Description
MVSD412	<input type="checkbox"/> Intended Settlement Date field <input type="checkbox"/> Submit button	The Intended Settlement Date of the instruction exceeds the predefined time frame for future-dated instructions	If the Intended Settlement Date of an instruction is a date in the future, the Intended Settlement Date must not exceed the predefined time frame for future-dated instructions.
MVSP208	<input type="checkbox"/> Priority field <input type="checkbox"/> Submit button	'Reserved priority' not allowed for the Instructing Party Type (only CSDs can use it)	'Reserved priority' is allowed in a Settlement Instruction only if the Instructing Party is a CSD
MVSQL602	<input type="checkbox"/> ISIN field <input type="checkbox"/> Settlement Quantity field <input type="checkbox"/> Securities Transaction Type field <input type="checkbox"/> Submit button	The Settlement Quantity stated in the instruction is not expressed using the same Settlement Type specified in T2S Reference Data.	The Settlement Quantity stated in a Settlement Instruction with exchange of Securities must be expressed using the same Settlement Type as the one specified in T2S Reference Data for the ISIN Code of the Instruction.
MVSQL604	<input type="checkbox"/> ISIN field <input type="checkbox"/> Settlement Quantity field <input type="checkbox"/> Settlement Type field <input type="checkbox"/> Submit button	The Settlement Quantity of the Settlement Instruction is lower than the Minimum Settlement Unit	The Settlement Quantity specified in a Settlement Instruction with exchange of securities and not related to a 'Corporate Action', 'Market Claim' or 'Transformation', must be equal or greater than the Minimum Settlement Unit specified in T2S.

Reference for error message	Field or Button	Error Text	Description
MVSQ606	<input type="checkbox"/> ISIN field <input type="checkbox"/> Settlement Quantity field <input type="checkbox"/> Settlement Transaction Type field <input type="checkbox"/> Submit button <input type="checkbox"/> n/a	The Settlement Quantity of the Settlement Instruction is neither a multiple of Settlement Unit Multiple nor a Deviating Settlement Unit.	The Settlement Quantity of a Settlement Instruction with exchange of securities and not related to a 'Corporate Action', 'Market Claim' or 'Transformation', must be a multiple of the Settlement Unit Multiple or a Deviating Settlement Unit.
MVSQ610	<input type="checkbox"/> Settlement Quantity field <input type="checkbox"/> Settlement Transaction Type field <input type="checkbox"/> Submit button <input type="checkbox"/> n/a	The remaining Settlement Quantity of the Settlement Instruction is neither a multiple of Settlement Unit Multiple nor a Deviating Settlement Unit.	In case of a partially settled Settlement Instruction with exchange of securities and not related to a 'Corporate Action', 'Market Claim' or 'Transformation', the remaining Settlement Quantity must be a multiple unit of the Settlement Unit Multiple or a Deviating Settlement Unit.
MVIC315	<input type="checkbox"/> ISIN field <input type="checkbox"/> Intended Settlement Date field <input type="checkbox"/> Securities Account Number field <input type="checkbox"/> Securities Movement Type Code field <input type="checkbox"/> Receiving Depository BIC field	The ISIN Code of the Settlement Instruction is not eligible for settlement in the receiving CSD.	The ISIN Code of a receiving Settlement Instruction must be eligible for settlement in the receiving CSD on the Intended Settlement Date and additionally on the current Business Day if the Intended Settlement Date is in the past.

Reference for error message	Field or Button	Error Text	Description
	<input type="checkbox"/> Submit button		
MVIC316	<input type="checkbox"/> ISIN field <input type="checkbox"/> Delivering Depository BIC field <input type="checkbox"/> Externally Matched field <input type="checkbox"/> Intended Settlement Date field <input type="checkbox"/> Receiving Depository BIC field <input type="checkbox"/> Securities Movement Type Code field <input type="checkbox"/> Submit button	The ISIN Code of the already matched Settlement Instruction is not eligible for settlement in the delivering or receiving CSD.	The ISIN Code of an already matched Settlement Instruction must be eligible for settlement in the delivering and receiving CSD on the Intended Settlement Date and additionally on the current Business Day if the Intended Settlement Date is in the past.
MVIC317	<input type="checkbox"/> ISIN field <input type="checkbox"/> Intended Settlement Date field <input type="checkbox"/> Securities Account Number field <input type="checkbox"/> Securities Movement Type Code field <input type="checkbox"/> Submit button	The ISIN Code of the delivering Settlement Instruction is not eligible for settlement in the delivering Issuance Account.	The delivering Issuance Account in a delivering Settlement Instruction must be eligible for settlement in the CSD of the delivering Issuance Account, which must also be the issuer CSD for the ISIN Code specified in the instruction, on the Intended Settlement Date and additionally on the current Business Day if the Intended Settlement Date is in the past.
MVIC318	<input type="checkbox"/> ISIN field <input type="checkbox"/> Intended Settlement Date field	The ISIN Code of the receiving Settlement Instruction is not eli-	The receiving Issuance Account in a receiving Settlement Instruction must be eligible for settlement in

Reference for error message	Field or Button	Error Text	Description
	<ul style="list-style-type: none"> <input type="checkbox"/> Securities Account Number field <input type="checkbox"/> Securities Movement Type Code field <input type="checkbox"/> Submit button 	gible for settlement in the receiving Issuance Account.	the CSD of the receiving Issuance Account, which must also be the issuer CSD for the ISIN Code specified in the instruction, on the Intended Settlement Date and additionally on the current Business Day if the Intended Settlement Date is in the past.
MVIC319	<ul style="list-style-type: none"> <input type="checkbox"/> ISIN field <input type="checkbox"/> Intended Settlement Date field <input type="checkbox"/> Securities Account Number field <input type="checkbox"/> Submit button <input type="checkbox"/> Externally Matched field <input type="checkbox"/> Securities Account field 	The ISIN Code of the already matched Settlement Instruction is not eligible for settlement in the delivering Issuance Account.	The delivering Issuance Account in an already matched Settlement Instruction must be eligible for settlement in the CSD of the delivering Issuance Account, which must also be the issuer CSD for the ISIN Code specified in the instruction, on the Intended Settlement Date and additionally on the current Business Day if the Intended Settlement Date is in the past.
MVIC320	<ul style="list-style-type: none"> <input type="checkbox"/> ISIN field <input type="checkbox"/> Intended Settlement Date field <input type="checkbox"/> Securities Account Number field <input type="checkbox"/> Submit button 	The ISIN Code of the already matched Settlement Instruction is not eligible for settlement in the receiving Issuance Account.	The receiving Issuance Account in an already matched Settlement Instruction must be eligible for settlement in the CSD of the receiving Issuance Account, which

Reference for error message	Field or Button	Error Text	Description
	<ul style="list-style-type: none"> <input type="checkbox"/> Securities Account field <input type="checkbox"/> Externally Matched field 		must also be the issuer CSD for the ISIN Code specified in the instruction, on the Intended Settlement Date and additionally on the current Business Day if the Intended Settlement Date is in the past.
MVCA517	<ul style="list-style-type: none"> <input type="checkbox"/> Debit Credit Indicator field <input type="checkbox"/> T2S Dedicated Cash Account Number field <input type="checkbox"/> Intended Settlement Date field <input type="checkbox"/> Payment Type Code field <input type="checkbox"/> Submit button 	The Debtor Party BIC stated in the Settlement Instruction is not the same as the Account Owner BIC of the debited T2S Dedicated Cash Account on the settlement date.	The Debtor Party BIC stated in a Settlement Instruction that debits cash must be the Party BIC of the owner of the debited T2S Dedicated Cash Account on the Intended Settlement Date and additionally on the current Business Day if the Intended Settlement Date is in the past.
MVCA518	<ul style="list-style-type: none"> <input type="checkbox"/> Debit Credit Indicator field <input type="checkbox"/> T2S Dedicated Cash Account field <input type="checkbox"/> Intended Settlement Date field <input type="checkbox"/> Payment Type Code field <input type="checkbox"/> Submit button 	The Creditor Party BIC stated in the Settlement Instruction is not the same as the Account Owner BIC of the credited T2S Dedicated Cash Account on the settlement date.	The Creditor Party BIC stated in a Settlement Instruction that credits cash must be the Party BIC of the owner of the credited T2S Dedicated Cash Account on the Intended Settlement Date and additionally on the current Business Day if the Intended Settlement Date is in the past.

Reference for error message	Field or Button	Error Text	Description
MVCP092	<input type="checkbox"/> Party Hold field <input type="checkbox"/> Submit button	The sender of a Settlement Instruction with a Party Hold activated is not authorised to send a Settlement Instruction with Party Hold on behalf of an external CSD.	If the relevant Depository is an external CSD, the sender of a Settlement Instruction with a Party Hold activated must be authorised to send a Settlement Instruction with Party Hold on behalf of that external CSD.
MVCP102	<input type="checkbox"/> Delivering Depository BIC field <input type="checkbox"/> Submit button	The Delivering Depository informed in a Settlement Instruction does not exist in T2S.	The Delivering Depository informed in a Settlement Instruction must exist in T2S.
MVCP103	<input type="checkbox"/> Receiving Depository BIC field <input type="checkbox"/> Submit button	The Receiving Depository informed in a Settlement Instruction does not exist in T2S.	The Receiving Depository informed in a Settlement Instruction must exist in T2S.
MVCP124	<input type="checkbox"/> Party Hold field <input type="checkbox"/> External Matched field <input type="checkbox"/> Securities Account field <input type="checkbox"/> Securities Account field <input type="checkbox"/> Submit button	The sender of a Settlement Instruction is not authorised to perform a Party Hold on the Securities Account of the counterparty.	The sender of an already matched Settlement Instruction with Party Hold activated must be authorised to perform a Party Hold on the Securities Account of the counterparty.
MVCP125	<input type="checkbox"/> Party Hold field <input type="checkbox"/> External Matched field <input type="checkbox"/> Securities Account field <input type="checkbox"/> Securities Account field	The sender of a Settlement Instruction is not authorised to perform a Party Hold on behalf of the external CSD of the counterparty.	If the Depository of the counterpart is an external CSD, the sender of an already matched Settlement Instruction with Party Hold activated must

Reference for error message	Field or Button	Error Text	Description
	<input type="checkbox"/> Submit button		be authorised to perform a Party Hold on behalf of that external CSD.
MVCP126	<input type="checkbox"/> CSD Hold field <input type="checkbox"/> External Matched field <input type="checkbox"/> Securities Account field <input type="checkbox"/> Securities Account field <input type="checkbox"/> Submit button	The sender of a Settlement Instruction is not authorised to perform a CSD Hold on the Securities Account of the counterparty.	The sender of an already matched Settlement Instruction with CSD Hold activated must be authorised to perform a CSD Hold on the Securities Account of the counterparty.
MVCP127	<input type="checkbox"/> CSD Hold field <input type="checkbox"/> External Matched field <input type="checkbox"/> Receiving Depository BIC field <input type="checkbox"/> Delivering Depository BIC field <input type="checkbox"/> Submit button	The sender of a Settlement Instruction is not authorised to perform a CSD Hold on behalf of the parent CSD of the external CSD of the counterparty.	If the Depository of the counterpart is an external CSD, the sender of an already matched Settlement Instruction with a CSD Hold activated must be authorised to perform a CSD Hold on behalf of the parent CSD of the external CSD.
MVCP119	<input type="checkbox"/> Instructing Party BIC field <input type="checkbox"/> Instructing Party Parent BIC field <input type="checkbox"/> Submit button	The sender of a Settlement Instruction is not authorised to send a Settlement Instruction using this Instructing Party.	If the sender of a Settlement Instruction does not belong to the Instructing Party, then the sender of a Settlement Instruction must be authorised to send a Settlement Instruction using the Instructing Party.

Reference for error message	Field or Button	Error Text	Description
MVDC024	<input type="checkbox"/> Instructing Party BIC field	The Instructing Party specified in a Settlement Instruction must exist in T2S Static Data.	The Instructing Party specified in the Settlement Instruction does not exist in T2S Static Data.
MVCP110	<input type="checkbox"/> External Matched field <input type="checkbox"/> Submit button	The sender of an already matched Settlement Instruction is not authorised to send a Settlement Instruction on behalf of the external CSD of the counterparty.	If the Depository of the counterparty is an external CSD, the sender of an already matched Settlement Instruction must be authorised to send a Settlement Instruction on behalf of that external CSD.
MVCP099	<input type="checkbox"/> Reference Type field <input type="checkbox"/> Reference field <input type="checkbox"/> Submit button	The Reference Owner of the Linked Instruction does not belong to the CSD (parent CSD in case of an external CSD) or NCB of the Instructing Party.	If a T2S actor wants to make use of linkages across several instructions sent to T2S via different CSDs or NCBs he holds accounts with, the T2S actor has to make use of the T2S reference.
MVLI869	<input type="checkbox"/> Reference field <input type="checkbox"/> Submit button	The Linked Instruction, referenced by a T2S Instruction Reference, does not exist.	If the reference indicated in the linkage section is the T2S Instruction Reference, then the referenced Settlement Instruction or Settlement Restriction must exist in T2S.

Reference for error message	Field or Button	Error Text	Description
MVLI872	<input type="checkbox"/> Link Type field <input type="checkbox"/> Reference field <input type="checkbox"/> Submit button	The Processing Position must be specified.	If a Settlement Instruction specifies a link with another instruction using a T2S Actor Instruction Reference or a T2S Instruction Reference , the Processing Position must be specified
MVLI875	<input type="checkbox"/> Link Type field <input type="checkbox"/> Submit button	The instruction cannot be linked to a Pool with a Processing Position with AFTER or BEFORE.	If a Settlement Instruction specifies a link to a Pool , if the Processing Position for this link is specified, it only can be WITH
MVCP052	<input type="checkbox"/> Securities Transaction Type field <input type="checkbox"/> Submit button	The sender of the Settlement Instruction is not authorised to send a Settlement Instruction using this ISO Transaction Code.	The sender of a Settlement Instruction must be authorised to send a Settlement Instruction using the ISO Transaction Code CNCB.
MVCP053	<input type="checkbox"/> Securities Transaction Type field <input type="checkbox"/> Submit button	The sender of the Settlement Instruction is not authorised to send a Settlement Instruction using this ISO Transaction Code.	The sender of a Settlement Instruction must be authorised to send a Settlement Instruction using the ISO Transaction Code BSBK.
MVCP054	<input type="checkbox"/> Securities Transaction Type field <input type="checkbox"/> Submit button	The sender of the Settlement Instruction is not authorised to send a Settlement Instruction using this ISO Transaction Code.	The sender of a Settlement Instruction must be authorised to send a Settlement Instruction using the ISO Transaction Code COLI.

Reference for error message	Field or Button	Error Text	Description
MVCP055	<input type="checkbox"/> Securities Transaction Type field <input type="checkbox"/> Submit button	The sender of the Settlement Instruction is not authorised to send a Settlement Instruction using this ISO Transaction Code.	The sender of a Settlement Instruction must be authorised to send a Settlement Instruction using the ISO Transaction Code COLO.
MVCP056	<input type="checkbox"/> Securities Transaction Type field <input type="checkbox"/> Submit button	The sender of the Settlement Instruction is not authorised to send a Settlement Instruction using this ISO Transaction Code.	The sender of a Settlement Instruction must be authorised to send a Settlement Instruction using the ISO Transaction Code CONV.
MVCP057	<input type="checkbox"/> Securities Transaction Type field <input type="checkbox"/> Submit button	The sender of the Settlement Instruction is not authorised to send a Settlement Instruction using this ISO Transaction Code.	The sender of a Settlement Instruction must be authorised to send a Settlement Instruction using the ISO Transaction Code FCTA.
MVCP058	<input type="checkbox"/> Securities Transaction Type field <input type="checkbox"/> Submit button	The sender of the Settlement Instruction is not authorised to send a Settlement Instruction using this ISO Transaction Code.	The sender of a Settlement Instruction must be authorised to send a Settlement Instruction using the ISO Transaction Code INSP.
MVCP059	<input type="checkbox"/> Securities Transaction Type field <input type="checkbox"/> Submit button	The sender of the Settlement Instruction is not authorised to send a Settlement Instruction using this ISO Transaction Code.	The sender of a Settlement Instruction must be authorised to send a Settlement Instruction using the ISO Transaction Code ISSU.

Reference for error message	Field or Button	Error Text	Description
MVCP060	<input type="checkbox"/> Securities Transaction Type field <input type="checkbox"/> Submit button	The sender of the Settlement Instruction is not authorised to send a Settlement Instruction using this ISO Transaction Code.	The sender of a Settlement Instruction must be authorised to send a Settlement Instruction using the ISO Transaction Code MKDW.
MVCP061	<input type="checkbox"/> Securities Transaction Type field <input type="checkbox"/> Submit button	The sender of the Settlement Instruction is not authorised to send a Settlement Instruction using this ISO Transaction Code.	The sender of a Settlement Instruction must be authorised to send a Settlement Instruction using the ISO Transaction Code MKUP.
MVCP062	<input type="checkbox"/> Securities Transaction Type field <input type="checkbox"/> Submit button	The sender of the Settlement Instruction is not authorised to send a Settlement Instruction using this ISO Transaction Code.	The sender of a Settlement Instruction must be authorised to send a Settlement Instruction using the ISO Transaction Code NETT.
MVCP063	<input type="checkbox"/> Securities Transaction Type field <input type="checkbox"/> Submit button	The sender of the Settlement Instruction is not authorised to send a Settlement Instruction using this ISO Transaction Code.	The sender of a Settlement Instruction must be authorised to send a Settlement Instruction using the ISO Transaction Code NSYN.
MVCP064	<input type="checkbox"/> Securities Transaction Type field <input type="checkbox"/> Submit button	The sender of the Settlement Instruction is not authorised to send a Settlement Instruction using this ISO Transaction Code.	The sender of a Settlement Instruction must be authorised to send a Settlement Instruction using the ISO Transaction Code OWNE.

Reference for error message	Field or Button	Error Text	Description
MVCP065	<input type="checkbox"/> Securities Transaction Type field <input type="checkbox"/> Submit button	The sender of the Settlement Instruction is not authorised to send a Settlement Instruction using this ISO Transaction Code.	The sender of a Settlement Instruction must be authorised to send a Settlement Instruction using the ISO Transaction Code OWNI.
MVCP066	<input type="checkbox"/> Securities Transaction Type field <input type="checkbox"/> Submit button	The sender of the Settlement Instruction is not authorised to send a Settlement Instruction using this ISO Transaction Code.	The sender of a Settlement Instruction must be authorised to send a Settlement Instruction using the ISO Transaction Code PAIR.
MVCP067	<input type="checkbox"/> Securities Transaction Type field <input type="checkbox"/> Submit button	The sender of the Settlement Instruction is not authorised to send a Settlement Instruction using this ISO Transaction Code.	The sender of a Settlement Instruction must be authorised to send a Settlement Instruction using the ISO Transaction Code PLAC.
MVCP068	<input type="checkbox"/> Securities Transaction Type field <input type="checkbox"/> Submit button	The sender of the Settlement Instruction is not authorised to send a Settlement Instruction using this ISO Transaction Code.	The sender of a Settlement Instruction must be authorised to send a Settlement Instruction using the ISO Transaction Code PORT.
MVCP069	<input type="checkbox"/> Securities Transaction Type field <input type="checkbox"/> Submit button	The sender of the Settlement Instruction is not authorised to send a Settlement Instruction using this ISO Transaction Code.	The sender of a Settlement Instruction must be authorised to send a Settlement Instruction using the ISO Transaction Code REAL.

Reference for error message	Field or Button	Error Text	Description
MVCP070	<input type="checkbox"/> Securities Transaction Type field <input type="checkbox"/> Submit button	The sender of the Settlement Instruction is not authorised to send a Settlement Instruction using this ISO Transaction Code.	The sender of a Settlement Instruction must be authorised to send a Settlement Instruction using the ISO Transaction Code REDI.
MVCP071	<input type="checkbox"/> Securities Transaction Type field <input type="checkbox"/> Submit button	The sender of the Settlement Instruction is not authorised to send a Settlement Instruction using this ISO Transaction Code.	The sender of a Settlement Instruction must be authorised to send a Settlement Instruction using the ISO Transaction Code REDM.
MVCP072	<input type="checkbox"/> Securities Transaction Type field <input type="checkbox"/> Submit button	The sender of the Settlement Instruction is not authorised to send a Settlement Instruction using this ISO Transaction Code.	The sender of a Settlement Instruction must be authorised to send a Settlement Instruction using the ISO Transaction Code RELE.
MVCP073	<input type="checkbox"/> Securities Transaction Type field <input type="checkbox"/> Submit button	The sender of the Settlement Instruction is not authorised to send a Settlement Instruction using this ISO Transaction Code.	The sender of a Settlement Instruction must be authorised to send a Settlement Instruction using the ISO Transaction Code REPU.
MVCP074	<input type="checkbox"/> Securities Transaction Type field <input type="checkbox"/> Submit button	The sender of the Settlement Instruction is not authorised to send a Settlement Instruction using this ISO Transaction Code.	The sender of a Settlement Instruction must be authorised to send a Settlement Instruction using the ISO Transaction Code RODE.

Reference for error message	Field or Button	Error Text	Description
MVCP075	<input type="checkbox"/> Securities Transaction Type field <input type="checkbox"/> Submit button	The sender of the Settlement Instruction is not authorised to send a Settlement Instruction using this ISO Transaction Code.	The sender of a Settlement Instruction must be authorised to send a Settlement Instruction using the ISO Transaction Code RPTO.
MVCP076	<input type="checkbox"/> Securities Transaction Type field <input type="checkbox"/> Submit button	The sender of the Settlement Instruction is not authorised to send a Settlement Instruction using this ISO Transaction Code.	The sender of a Settlement Instruction must be authorised to send a Settlement Instruction using the ISO Transaction Code RVPO.
MVCP077	<input type="checkbox"/> Securities Transaction Type field <input type="checkbox"/> Submit button	The sender of the Settlement Instruction is not authorised to send a Settlement Instruction using this ISO Transaction Code.	The sender of a Settlement Instruction must be authorised to send a Settlement Instruction using the ISO Transaction Code SBBK.
MVCP078	<input type="checkbox"/> Securities Transaction Type field <input type="checkbox"/> Submit button	The sender of the Settlement Instruction is not authorised to send a Settlement Instruction using this ISO Transaction Code.	The sender of a Settlement Instruction must be authorised to send a Settlement Instruction using the ISO Transaction Code SBRE.
MVCP079	<input type="checkbox"/> Securities Transaction Type field <input type="checkbox"/> Submit button	The sender of the Settlement Instruction is not authorised to send a Settlement Instruction using this ISO Transaction Code.	The sender of a Settlement Instruction must be authorised to send a Settlement Instruction using the ISO Transaction Code SECB.

Reference for error message	Field or Button	Error Text	Description
MVCP080	<input type="checkbox"/> Securities Transaction Type field <input type="checkbox"/> Submit button	The sender of the Settlement Instruction is not authorised to send a Settlement Instruction using this ISO Transaction Code.	The sender of a Settlement Instruction must be authorised to send a Settlement Instruction using the ISO Transaction Code SECL.
MVCP081	<input type="checkbox"/> Securities Transaction Type field <input type="checkbox"/> Submit button	The sender of the Settlement Instruction is not authorised to send a Settlement Instruction using this ISO Transaction Code.	The sender of a Settlement Instruction must be authorised to send a Settlement Instruction using the ISO Transaction Code SLRE.
MVCP082	<input type="checkbox"/> Securities Transaction Type field <input type="checkbox"/> Submit button	The sender of the Settlement Instruction is not authorised to send a Settlement Instruction using this ISO Transaction Code.	The sender of a Settlement Instruction must be authorised to send a Settlement Instruction using the ISO Transaction Code SUBS.
MVCP083	<input type="checkbox"/> Securities Transaction Type field <input type="checkbox"/> Submit button	The sender of the Settlement Instruction is not authorised to send a Settlement Instruction using this ISO Transaction Code.	The sender of a Settlement Instruction must be authorised to send a Settlement Instruction using the ISO Transaction Code SYND.
MVCP084	<input type="checkbox"/> Securities Transaction Type field <input type="checkbox"/> Submit button	The sender of the Settlement Instruction is not authorised to send a Settlement Instruction using this ISO Transaction Code.	The sender of a Settlement Instruction must be authorised to send a Settlement Instruction using the ISO Transaction Code TBAC.

Reference for error message	Field or Button	Error Text	Description
MVCP085	<input type="checkbox"/> Securities Transaction Type field <input type="checkbox"/> Submit button	The sender of the Settlement Instruction is not authorised to send a Settlement Instruction using this ISO Transaction Code.	The sender of a Settlement Instruction must be authorised to send a Settlement Instruction using the ISO Transaction Code TRAD.
MVCP086	<input type="checkbox"/> Securities Transaction Type field <input type="checkbox"/> Submit button	The sender of the Settlement Instruction is not authorised to send a Settlement Instruction using this ISO Transaction Code.	The sender of a Settlement Instruction must be authorised to send a Settlement Instruction using the ISO Transaction Code TRPO.
MVCP087	<input type="checkbox"/> Securities Transaction Type field <input type="checkbox"/> Submit button	The sender of the Settlement Instruction is not authorised to send a Settlement Instruction using this ISO Transaction Code.	The sender of a Settlement Instruction must be authorised to send a Settlement Instruction using the ISO Transaction Code TRVO.
MVCP088	<input type="checkbox"/> Securities Transaction Type field <input type="checkbox"/> Submit button	The sender of the Settlement Instruction is not authorised to send a Settlement Instruction using this ISO Transaction Code.	The sender of a Settlement Instruction must be authorised to send a Settlement Instruction using the ISO Transaction Code TURN.
MVCP089	<input type="checkbox"/> Securities Transaction Type field <input type="checkbox"/> Submit button	The sender of the Settlement Instruction is not authorised to send a Settlement Instruction using this ISO Transaction Code.	The sender of a Settlement Instruction must be authorised to send a Settlement Instruction using the ISO Transaction Code CORP.

Reference for error message	Field or Button	Error Text	Description
MVCP090	<input type="checkbox"/> Securities Transaction Type field <input type="checkbox"/> Submit button	The sender of the Settlement Instruction is not authorised to send a Settlement Instruction using this ISO Transaction Code.	The sender of a Settlement Instruction must be authorised to send a Settlement Instruction using the ISO Transaction Code CLAI.
MVCP091	<input type="checkbox"/> Securities Transaction Type field <input type="checkbox"/> Submit button	The sender of the Settlement Instruction is not authorised to send a Settlement Instruction using this ISO Transaction Code.	The sender of a Settlement Instruction must be authorised to send a Settlement Instruction using the ISO Transaction Code AUTO.
MVCP128	<input type="checkbox"/> Securities Transaction Type field <input type="checkbox"/> Submit button	The sender of the Settlement Instruction is not authorised to send a Settlement Instruction using this ISO Transaction Code.	The sender of a Settlement Instruction must be authorised to send a Settlement Instruction using the ISO Transaction Code ETFT.
MVCP130	<input type="checkbox"/> Securities Transaction Type field <input type="checkbox"/> Submit button	The sender of the Settlement Instruction is not authorised to send a Settlement Instruction using this ISO Transaction Code.	The sender of a Settlement Instruction must be authorised to send a Settlement Instruction using the ISO Transaction Code BYIY.
MVCP131	<input type="checkbox"/> Securities Transaction Type field <input type="checkbox"/> Submit button	The sender of the Settlement Instruction is not authorised to send a Settlement Instruction using this ISO Transaction Code.	The sender of a Settlement Instruction must be authorised to send a Settlement Instruction using the ISO Transaction Code SWIF

Reference for error message	Field or Button	Error Text	Description
MVCP132	<input type="checkbox"/> Securities Transaction Type field <input type="checkbox"/> Submit button	The sender of the Settlement Instruction is not authorised to send a Settlement Instruction using this ISO Transaction Code.	The sender of a Settlement Instruction must be authorised to send a Settlement Instruction using the ISO Transaction Code SWIT
MVSQ612	<input type="checkbox"/> Settlement Quantity <input type="checkbox"/> Settlement Type <input type="checkbox"/> Submit button	The number of decimals of the Settlement Quantity of the Settlement Instruction is greater than the number of decimals of the Settlement Multiple of the related security	The number of decimals of the Settlement Quantity of a Settlement Instruction on Securities must be equal or lower than the number of decimals of the Settlement Unit Multiple of the related Security.
MVSR701	<input type="checkbox"/> Transaction Identification field <input type="checkbox"/> Submit button		A Settlement Instruction that fulfils a specific restriction configured by its System Entity with positive Restriction Processing Type 'CSD Validation Hold' is accepted, and its CSD Validation Hold Status is set to 'Yes'.
MVSR702	<input type="checkbox"/> Transaction Identification field <input type="checkbox"/> Submit button		A Settlement Instruction that fulfils a specific restriction configured by its System Entity with negative Restriction Processing Type 'CSD Validation Hold' is accepted, and

Reference for error message	Field or Button	Error Text	Description
			its CSD Validation Hold Status is set to 'No'.
MVSR703	<input type="checkbox"/> Transaction Identification field <input type="checkbox"/> Submit button	Settlement Instruction rejected due to a Restriction Type.	A new Settlement Instruction that fulfils a specific restriction configured by its System Entity with positive Restriction Processing Type 'Rejection' is rejected.
MVSR704	<input type="checkbox"/> Transaction Identification field <input type="checkbox"/> Submit button		A Settlement Instruction that fulfils a specific restriction configured by its System Entity with negative Restriction Processing Type 'Rejection' is not rejected nor cancelled.
MVSR707	<input type="checkbox"/> Transaction Identification field <input type="checkbox"/> Submit button	Settlement Instruction cancelled due to a Restriction Type.	An already existing Settlement Instruction that fulfils a specific restriction configured by its System Entity with positive Restriction Processing Type 'Rejection' is cancelled.

6.5.2.83 Settlement Instructions - Search/List Screen

△ [▶ 177]

Reference for error message	Field or Button	Error Text	Description
QMPC005	<input type="checkbox"/> Settlement Amount field <input type="checkbox"/> Search button	The lower limit of the Cash Amount range is more than the upper limit of the Cash Amount range.	In case the Cash Amount is stated as a range, the lower limit of the Cash Amount range must be less than the upper limit of the Cash Amount range.
QMPC006	<input type="checkbox"/> Quantity/Nominal field <input type="checkbox"/> Search button	The lower limit of the Securities Quantity range is greater than the upper limit of the Securities Quantity range.	In case the Securities Quantity is stated as a range, the lower limit of the Securities Quantity range must be less than the upper limit of the Securities Quantity range.
QMPC007	<input type="checkbox"/> Trade Date field <input type="checkbox"/> Search button	The Trade Date From is later than the Trade Date To.	In case the Trade Date is stated as a range, the Trade Date From must be before the Trade Date To, i.e. earlier or on the same day as the Trade Date To.
QMPC010	<input type="checkbox"/> Trade Date field <input type="checkbox"/> Intended Settlement Date field <input type="checkbox"/> Search button	The Trade Date From is after the Intended Settlement Date From.	In case the Trade Date and the Intended Settlement Date are specified, the Trade Date From must not be after the Intended Settlement Date From, i.e. it must be earlier or on the same day as the Intended Settlement Date From.
QMPC011	<input type="checkbox"/> Trade Date field <input type="checkbox"/> Actual Settlement Date field <input type="checkbox"/> Search button	The Trade Date From is after the Actual Settlement Date From.	In case the Trade Date and the Actual Settlement Date are specified, the Trade Date

Reference for error message	Field or Button	Error Text	Description
			From must not be after the Actual Settlement Date From, i.e. it must be earlier or on the same day as the Actual Settlement Date From.
QMPC012	<input type="checkbox"/> Intended Settlement Date field <input type="checkbox"/> Search button	The Intended Settlement Date From is after the Intended Settlement Date To.	In case the Intended Settlement Date is stated as a range, the Intended Settlement Date From must be before the Intended Settlement Date To, i.e. earlier or on the same day as the Intended Settlement Date To.
QMPC013	<input type="checkbox"/> Actual Settlement Date and Time field <input type="checkbox"/> Search button	The requested Actual Settlement Date From is older than three calendar months.	The requested Actual Settlement Date From must not be older than three calendar months.
QMPC014	<input type="checkbox"/> Actual Settlement Date and Time field <input type="checkbox"/> Search button	The Actual Settlement Date From is after the Actual Settlement Date To.	In case the Actual Settlement Date is stated as a range, the Actual Settlement Date From must be before the Actual Settlement Date To, i.e. earlier or on the same day as the Actual Settlement Date To.
QMPC018	<input type="checkbox"/> ISIN field <input type="checkbox"/> Search button	The specified ISIN is not known in T2S.	In case an ISIN is specified, it has to be known in T2S.
QMPC030	<input type="checkbox"/> Securities Account Number field <input type="checkbox"/> Search button	The specified Securities Account Number is not known in T2S.	In case a Securities Account Number is specified, it has to be known in T2S.

Reference for error message	Field or Button	Error Text	Description
QMPC031	<input type="checkbox"/> T2S Dedicated Cash Account Number field <input type="checkbox"/> Search button	The specified T2S Dedicated Cash Account Number is not known in T2S.	In case a T2S Dedicated Cash Account Number is specified, it has to be known in T2S.
QMPC032	<input type="checkbox"/> Instructing Party BIC field <input type="checkbox"/> Search button	The specified Party BIC is not known in T2S.	In case a Party BIC is specified, it has to be known in T2S.
QMPC048	<input type="checkbox"/> Instructing Party Parent BIC field	The specified Parent BIC is not known in T2S.	In case a Parent BIC is specified, it has to be known in T2S.
QMPC054	<input type="checkbox"/> Settlement Currency field <input type="checkbox"/> Search button	The specified Currency is not known in T2S.	In case a Currency is specified, it has to be known in T2S.

6.5.2.84 Status History - Details Screen

△ [▶ 267]

No references for error messages.

6.5.2.85 T2S BIC Directory Items - Search/List Screen

△

Reference for error message	Field or Button	Error Text	Description
DRDQ003	<input type="checkbox"/> Status field <input type="checkbox"/> Valid from field <input type="checkbox"/> Valid to field	Data to be updated not found	When performing a T2S BIC Directory deletion request it must refer to an existing and active instance of T2S BIC Directory already closed or with a future Valid From.
DRDQ004	<input type="checkbox"/> Status field <input type="checkbox"/> Valid from field	Data to be updated not found	When performing a T2S BIC Directory restore request it must refer to

Reference for error message	Field or Button	Error Text	Description
	<input type="checkbox"/> Valid to field		an existing and deleted instance of T2S BIC Directory already closed or with a future Valid From.
DRDQ005	<input type="checkbox"/> Party BIC field <input type="checkbox"/> Valid from field <input type="checkbox"/> Valid to field	BIC already assigned	When performing a T2S BIC Directory restore request it, the pair BIC and BIC Branch Code specified must not be already assigned in the same validity period.
QMPC021	<input type="checkbox"/> Valid from from field <input type="checkbox"/> Valid from to field <input type="checkbox"/> Search button	The From value of the Date From is after the To value of the Date From.	In case the Date From is stated as a range, the From value of the Date From has to be before or equal to the To value of the Date From.
QMPC022	<input type="checkbox"/> Valid from from field <input type="checkbox"/> Valid to to field <input type="checkbox"/> Search button	The From value of the Date From is after the To value of the Date To.	In case the Date From and Date To are specified as ranges, the From value of the Date From has to be before or equal to the To value of the Date To.
QMPC023	<input type="checkbox"/> Valid to from field <input type="checkbox"/> Valid to to field <input type="checkbox"/> Search button	The From value of the Date From is after the To value of the Date To.	In case the To Date is stated as a range, the From value of the Date To has to be before or equal to the To value of the Date To.

6.5.2.86 T2S DCA Balance - Details Screen

△ [▶ 362]

No references for error messages.

6.5.2.87 T2S DCA Balances - Search/List Screen

△ [▶ 358]

Reference for error message	Field or Button	Error Text	Description
QMPC031	<input type="checkbox"/> Search button <input type="checkbox"/> T2S Dedicated Cash Account Number field	The specified T2S Dedicated Cash Account Number is not known in T2S.	In case a T2S Dedicated Cash Account Number is specified, it has to be known in T2S.
QMPC032	<input type="checkbox"/> Party BIC field <input type="checkbox"/> Search button	The specified Party BIC is not known in T2S.	In case a Party BIC is specified, it has to be known in T2S.
QMPC048	<input type="checkbox"/> NCB Parent BIC field <input type="checkbox"/> Search button	The specified Parent BIC is not known in T2S.	In case a Parent BIC is specified, it has to be known in T2S.
QMPC054	<input type="checkbox"/> Currency field <input type="checkbox"/> Search button	The specified Currency is not known in T2S.	In case a Currency is specified, it has to be known in T2S.
QMPC072	<input type="checkbox"/> Party BIC field <input type="checkbox"/> NCB Parent BIC field <input type="checkbox"/> T2S Dedicated Cash Account Number field <input type="checkbox"/> Currency field <input type="checkbox"/> Search button	The specified combination of T2S Dedicated Cash Account Number, Currency, Account Owner and Account Servicer are not consistent.	In case at least two of the following selection criteria are specified, they have to be consistent, i. e. the T2S Dedicated Cash Account is owned by the specified Party <ul style="list-style-type: none"> • T2S Dedicated Cash Account Number • Account Owner • Account Servicer • Currency, in which the T2S Dedicated Cash Account is issued and/or in which the Party owns T2SDedicated Cash Accounts

Reference for error message	Field or Button	Error Text	Description
QMPC073	<input type="checkbox"/> Date field <input type="checkbox"/> Search button	The specified Date is in the future.	In case a date from is specified, it must not be in the future.
QMPC084	<input type="checkbox"/> Party BIC field <input type="checkbox"/> NCB Parent BIC field <input type="checkbox"/> Search button	The specified Parent BIC is not the System Entity of the specified party.	In case the BIC of a party as well as its parent BIC are specified, a party with these two BICs has to be known in T2S.
QMPC091	<input type="checkbox"/> Restriction Type field <input type="checkbox"/> Search button	The specified restriction type is not known in T2S.	In case a restriction type is specified, it has to be known in T2S.

6.5.2.88 T2S DCA Postings - Search/List Screen

△ [▶ 364]

Reference for error message	Field or Button	Error Text	Description
QMPC016	<input type="checkbox"/> Date field <input type="checkbox"/> Search Button	The Date From is older than three calendar months.	The Date From must not be older than three calendar months.
QMPC032	<input type="checkbox"/> Party BIC field <input type="checkbox"/> Search button	The specified Party BIC is not known in T2S.	In case a Party BIC is specified, it has to be known in T2S.
QMPC054	<input type="checkbox"/> Currency field <input type="checkbox"/> Search button	The specified Currency is not known in T2S.	In case a Currency is specified, it has to be known in T2S.
QMPC072	<input type="checkbox"/> Party BIC field <input type="checkbox"/> NCB Parent BIC field <input type="checkbox"/> T2S Dedicated Cash Account field <input type="checkbox"/> Currency field <input type="checkbox"/> Search button	The specified combination of T2S Dedicated Cash Account Number, Currency, Account Owner and Account Servicer are not consistent.	In case at least two of the following selection criteria are specified, they have to be consistent, i. e. the T2S Dedicated Cash Account is owned by the specified Party <ul style="list-style-type: none"> • T2S Dedicated Cash

Reference for error message	Field or Button	Error Text	Description
			Account Number <ul style="list-style-type: none"> • Account Owner • Account Servicer • Currency, in which the T2S Dedicated Cash Account is issued and/or in which the Party owns T2SDedicated Cash Accounts
QMPC073	<input type="checkbox"/> Date field <input type="checkbox"/> Date and Time from field <input type="checkbox"/> Search button	The specified Date is in the future.	In case a date from is specified, it must not be in the future.
QMPC091	<input type="checkbox"/> Restriction Type field <input type="checkbox"/> Search button	The specified restriction type is not known in T2S.	In case a restriction type is specified, it has to be known in T2S.

6.5.2.89 Total Amount of Standing/Predefined Liquidity Transfer Orders - Search/List Screen

△ [▶ 401]

Reference for error message	Field or Button	Error Text	Description
QMPC032	<input type="checkbox"/> Party BIC field <input type="checkbox"/> Search button	The specified Party BIC is not known in T2S.	In case a Party BIC is specified, it has to be known in T2S.
QMPC048	<input type="checkbox"/> Parent BIC field <input type="checkbox"/> Search button	The specified Parent BIC is not known in T2S.	In case a Parent BIC is specified, it has to be known in T2S.
QMPC084	<input type="checkbox"/> Parent BIC field <input type="checkbox"/> Party BIC field <input type="checkbox"/> Search button	The specified Parent BIC is not the System Entity of the specified party.	In case the BIC of a party as well as its parent BIC are specified, a party with these two BICs has to be known in T2S.

6.5.2.90 Total Collateral Value per T2S Dedicated Cash Account - Search/List Screen

△ [▶ 370]

Reference for error message	Field or Button	Error Text	Description
QMPC031	<input type="checkbox"/> Search button <input type="checkbox"/> T2S Dedicated Cash Account Number field	The specified T2S Dedicated Cash Account Number is not known in T2S.	In case a T2S Dedicated Cash Account Number is specified, it has to be known in T2S.
QMPC032	<input type="checkbox"/> Search button <input type="checkbox"/> T2S Dedicated Cash Account Owner Party BIC field <input type="checkbox"/> NCB Parent BIC field <input type="checkbox"/> Securities Account Owner Party BIC field <input type="checkbox"/> CSD Parent BIC field	The specified Party BIC is not known in T2S.	In case a Party BIC is specified, it has to be known in T2S.
QMPC054	<input type="checkbox"/> Currency field <input type="checkbox"/> Search button	The specified Currency is not known in T2S.	In case a Currency is specified, it has to be known in T2S.
QMPC084	<input type="checkbox"/> CSD Parent BIC field <input type="checkbox"/> Securities Account Owner Party BIC field	The specified Parent BIC is not the System Entity of the specified party.	In case the BIC of a party as well as its parent BIC are specified, a party with these two BICs has to be known in T2S.

6.5.3 References for Error Messages for TMS Screens

6.5.3.1 Trouble Case - Search/List Screen

△ [▶ 843]

Reference for error message	Field or Button	Error Text	Description
ARERR10000	<input type="checkbox"/> From field <input type="checkbox"/> To field <input type="checkbox"/> Search button	Dates into From and To fields are not congruous. Check values!	In case the Date is stated as a range, the Date From has to be before or equal to the Date To.

6.5.3.2 Trouble Case - Details Screen

△ [▶ 849]

No references for error messages.

6.5.3.3 Trouble Case - Export Screen

△ [▶ 855]

Reference for error message	Field or Button	Error Text	Description
ARERR10000	<input type="checkbox"/> From field <input type="checkbox"/> To field	Dates into From and To fields are not congruous. Check values!	In case the Date is stated as a range, the Date From has to be before or equal to the Date To.